

Register your product and get support at
www.philips.com/welcome

4100 series - LED TV

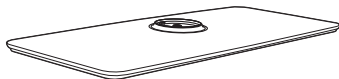

(BR)

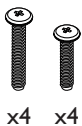
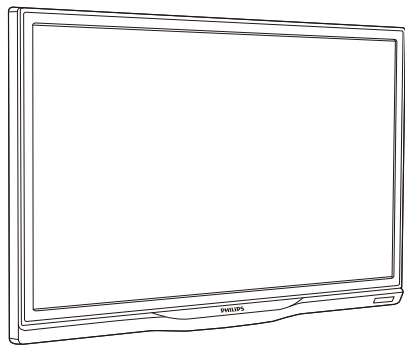

(AR)

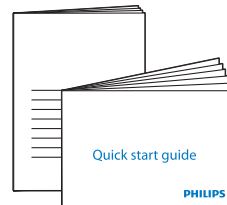

PHILIPS



p.3

or

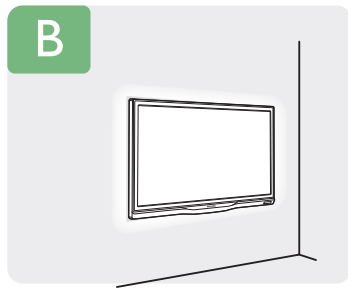

p.5



English Read the safety instructions.

Português Leia as instruções de segurança.

Español Lea la información de seguridad.

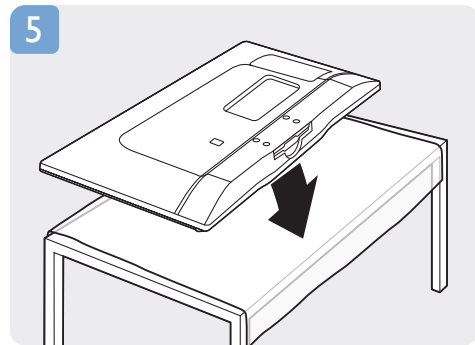
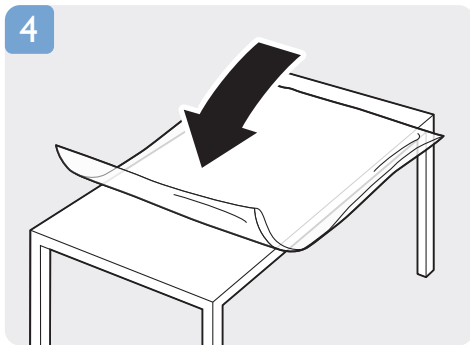
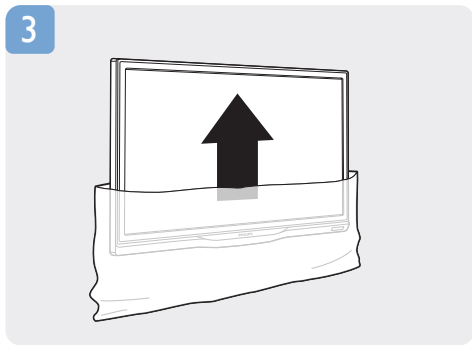
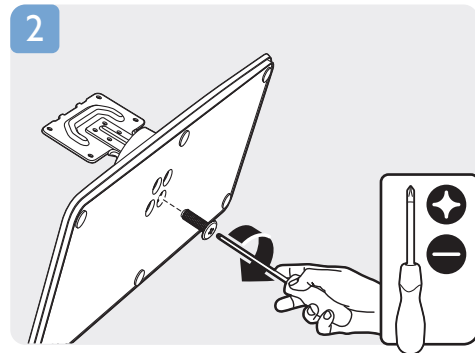
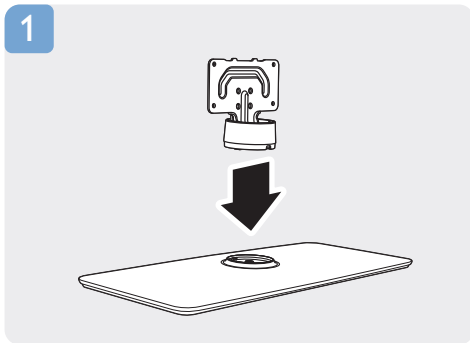
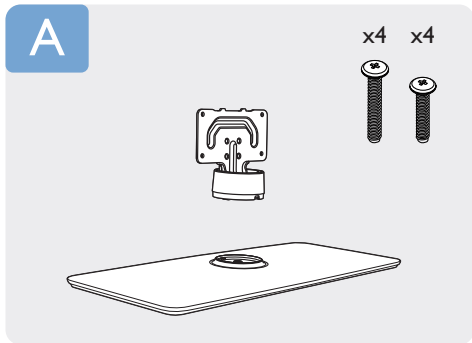

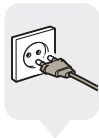
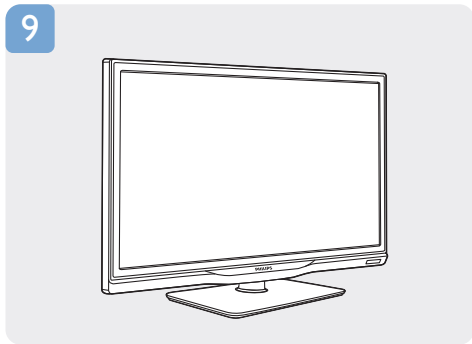
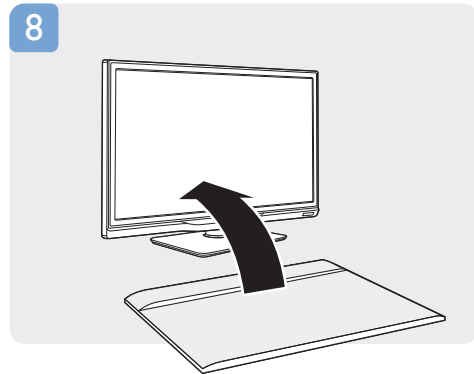
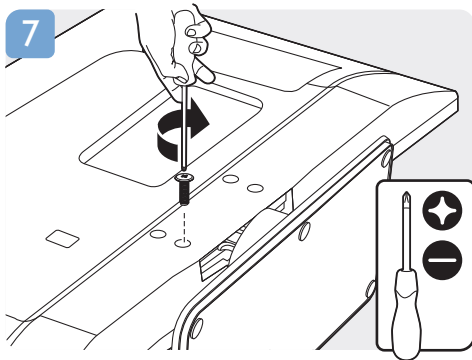
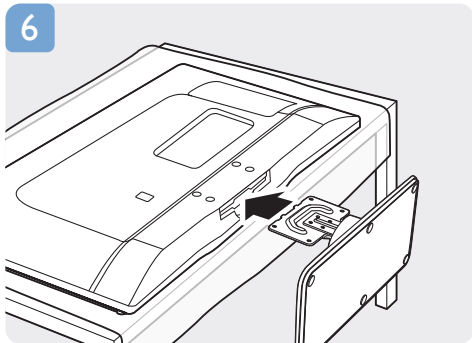

p.6

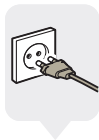
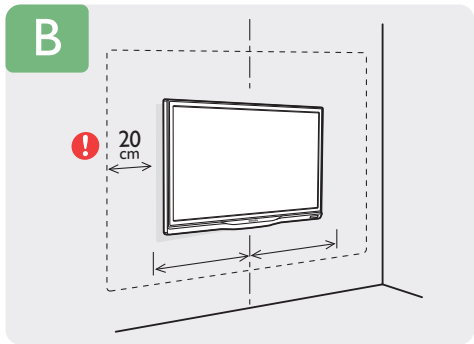

p.6

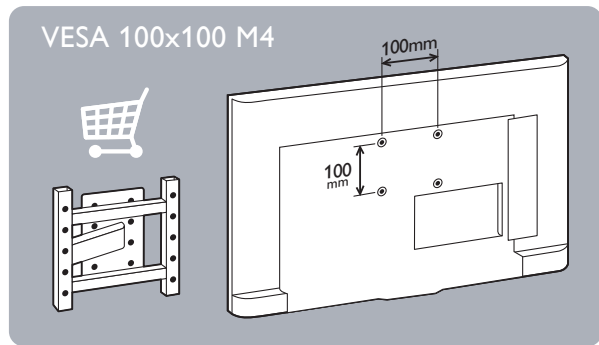

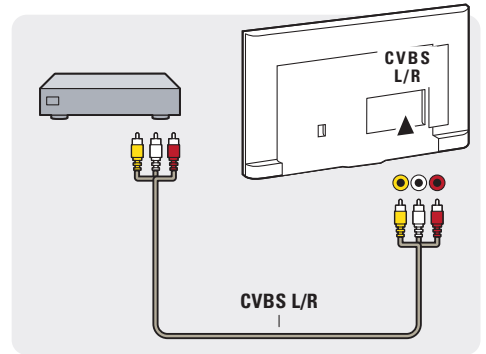
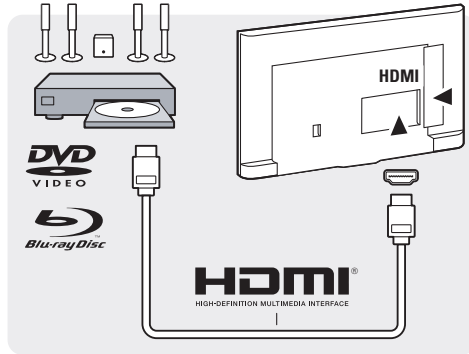
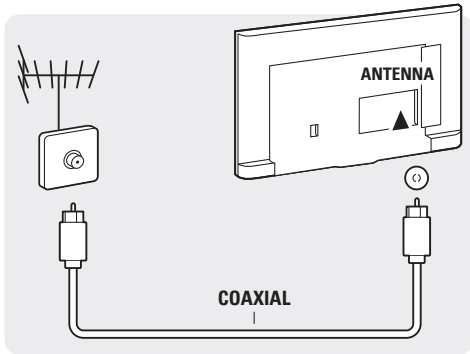
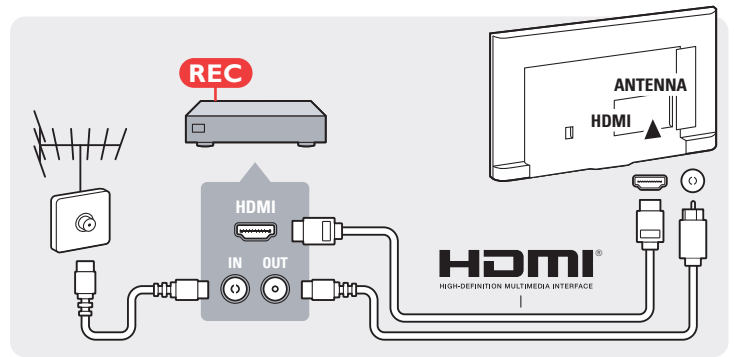
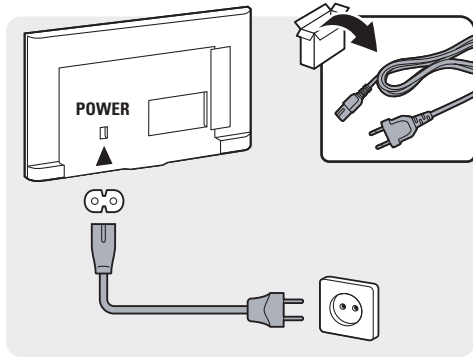
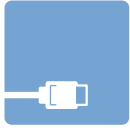

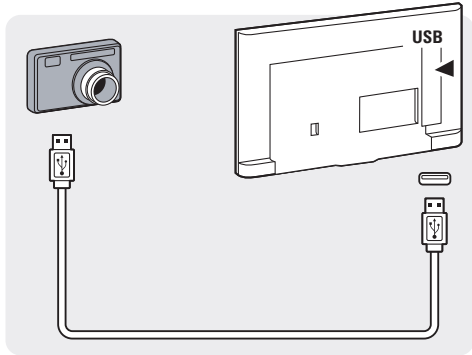
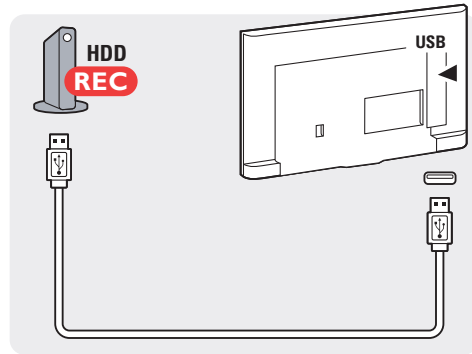
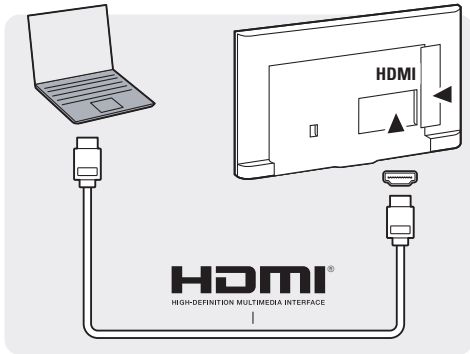
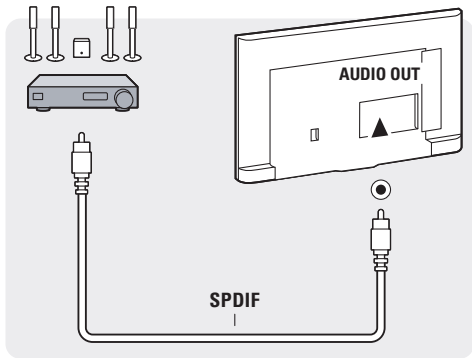

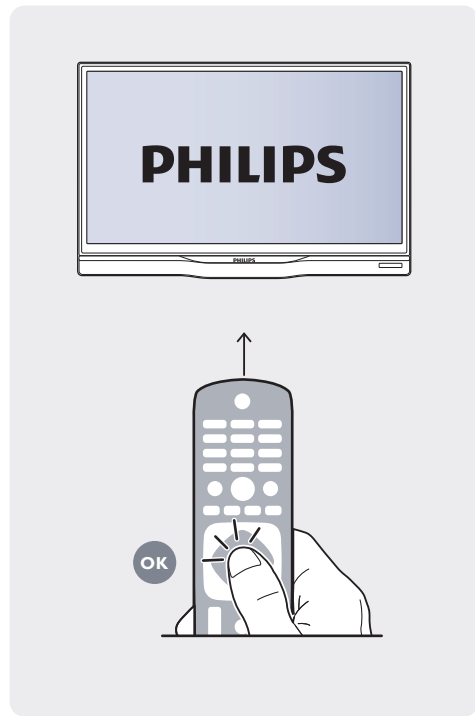
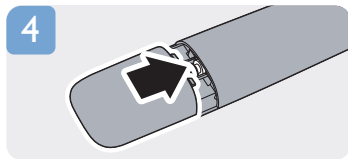
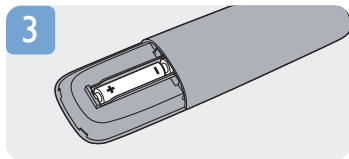
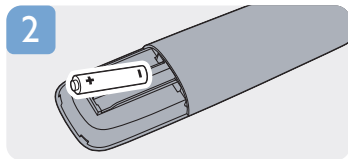
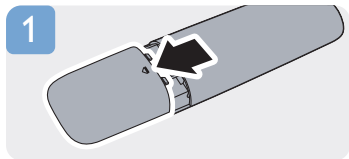



Always here to help you

www.philips.com/support



User Manual



Frequently Asked Questions



Warranty



Philips support forum



Live Chat



Call Center



Email

България
Грижа за клиента
02 4916 273
(Национален номер)

België/Belgique
Klantenservice/
Service Consommateurs
070 700 035
(0,15€/min.)

Bosna i Hercegovina
Potpora potrošačima
033 941 251
(Lokalni poziv)

Србија
Potpora potrošačima
011 321 6840
(Lokalni poziv)

Česká republika
Zákaznická podpora
228 880 895
(Místní tarif)

Danmark
Kundeservice
3525 8314

Deutschland
Kundendienst
069 66 80 10 10
(Zum Festnetztarif ihres Anbieters)

Ελλάδα
Τμήμα καταναλωτών
2111983028
(Διεθνής κλήση)

Eesti
Klienditugi
6683061
(Kohalikud kõned)

España
Atención al consumidor
902 88 10 83
(0,10€ + 0,08€/min.)
France
Service Consommateurs
01 57 32 40 50
(coût d'un appel local sauf surcoût éventuel selon opérateur réseau)

Hrvatska
Potpora potrošačima
01 777 66 01
(Lokalni poziv)

Ireland
Consumer Care
0818 210 140
(National call)

Italia
Servizio Consumatori
02 45287014
(Chiamata nazionale)

Қазақстан Республикасы
байланыс орталығы
810 800 2000 00 04
(стационарлық нөмірлерден
Қазақстан Республикасы бойынша
конфирмау шалу тегін)

Latvija
Klientu atbalsts
6616 3263
(Vietēlais tarifs)

Lietuva
Klientų palaikymo tarnyba
8 52140293
(Vietinai tarifais)

Luxembourg
Service Consommateurs
2487 1100
(Appel national)/(Nationale Ruf)

Magyarország
Ügyfélszolgálat
(06 1) 700 8151
(Belföldi hívás)

Nederland
Klantenservice
0900 202 08 71
(0,10€/min.)

Norge
Forbrukerstøtte
22 97 19 14

Österreich
Kundendienst
0820 40 11 33
(0,145€/Min.)

Республика Беларусь
Контакт Центр
8 10 (800) 2000 00 04
(бесплатный звонок по
Республике Беларусь со стационарных
номеров)

Российская Федерация
Контакт Центр
8 (800) 220 00 04
бесплатный звонок по России

Polska
Wsparcie Klienta
22 3971504
(Połączenie lokalne)

Portugal
Assistência a clientes
707 78 02 25
(0,12€/min. – Móvel 0,30€/min.)

România
Serviciul Clienti
031 6300042
(Tarif local)

Schweiz/Suisse/Svizzera
Kundendienst/Service Consommateurs/
Servizio Consumatori
0848 000 291
(0,081 CHF/Min)

Slovenija
Skrb za potrošnike
01 8888 312
(Lokalni klic)

Slovensko
Zákaznická podpora
02 - 33215493
(vnútroštátny hovor)

Suomi
Finland Kuluttajapalvelu
09 8862 5040

Sverige
Kundtjänst
08-5792 9096

Türkiye
Tüketici Hizmetleri
444 8 445

Україна
Служба підтримки споживачів
0-800-500-480
(зв'язки зі стационарних телефонів
безкоштовні)

United Kingdom
Consumer Care
0844 338 04 88
(5p/min BT landline)

Argentina
Consumer Care
0800 444 7749

Buenos Aires
Consumer Care
0810 444 7782

Brasil
Suporte ao Consumidor
0800 701 0245

Brasil (São Paulo)
Suporte ao Consumidor
2938 0245



All registered and unregistered trademarks are the property of their respective owners.

Specifications are subject to change without notice.

Philips and the Philips' Shield Emblem are registered trademarks of Koninklijke Philips N.V. and are used under license from Koninklijke Philips N.V.

2014 © TP Vision Europe B.V. All rights reserved. www.philips.com

