

PHILIPS

7805 series

Quick Start Guide

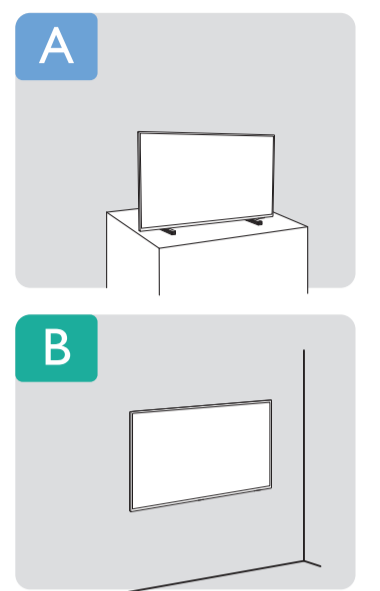
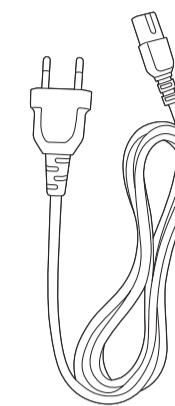
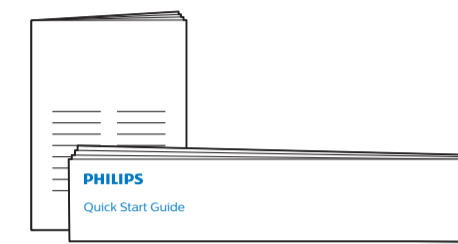
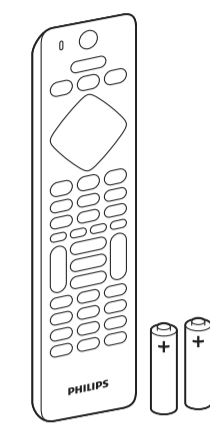
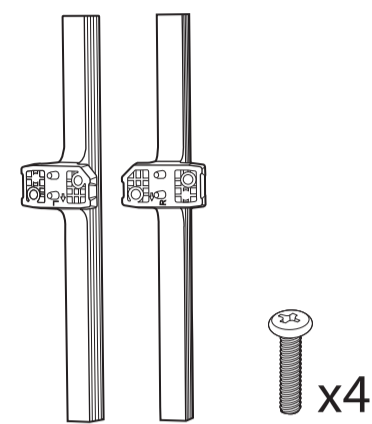
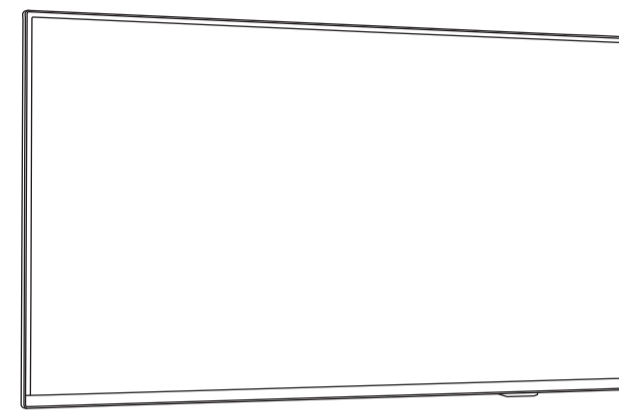

A

1

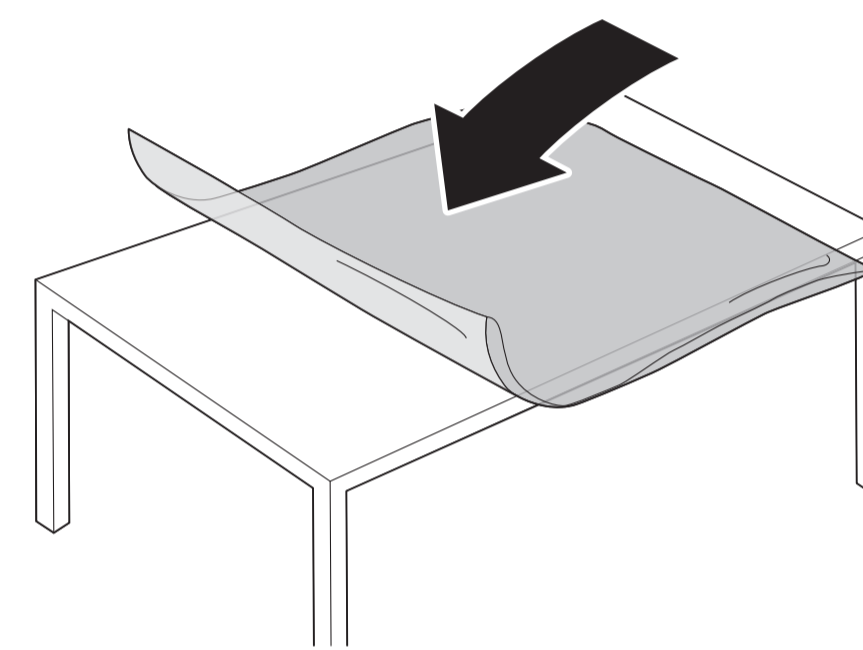
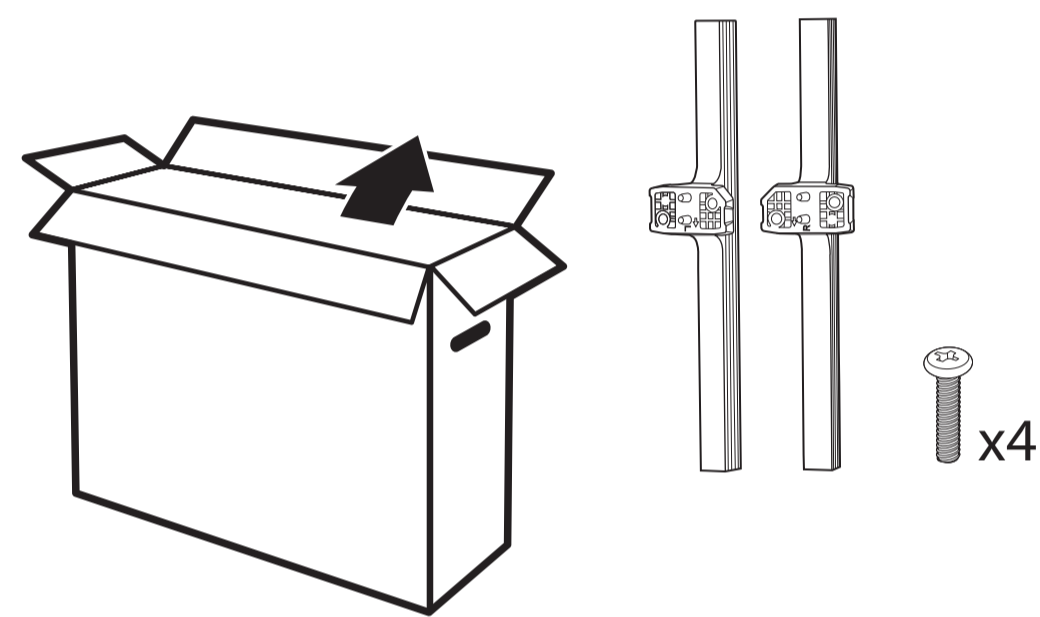

2

3

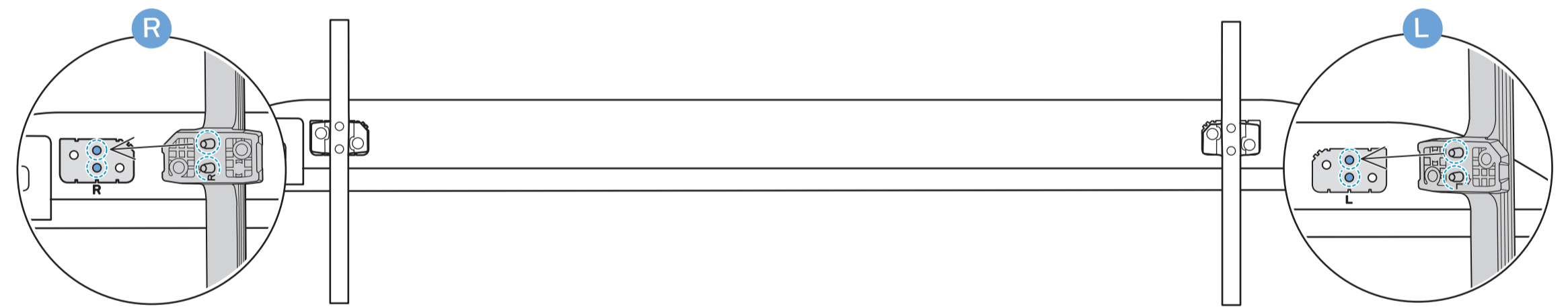
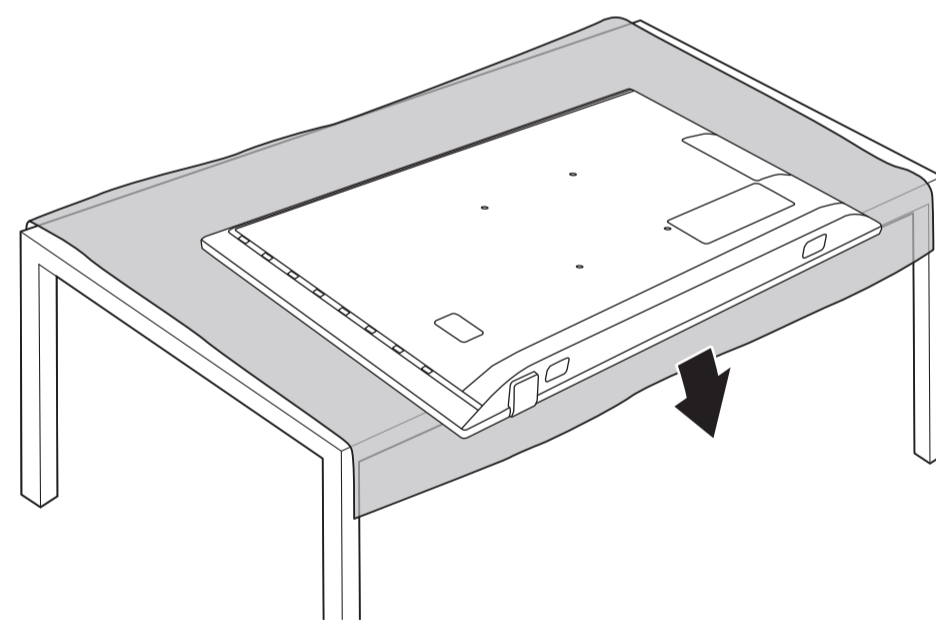

4

5

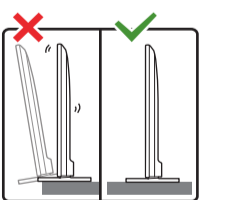
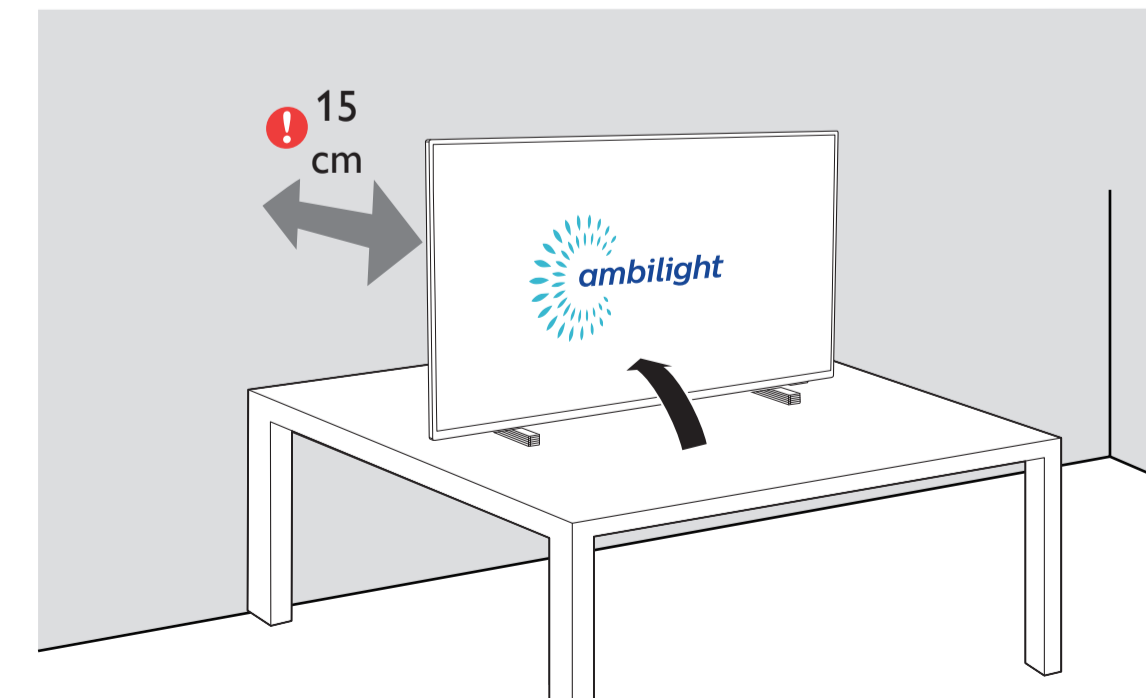
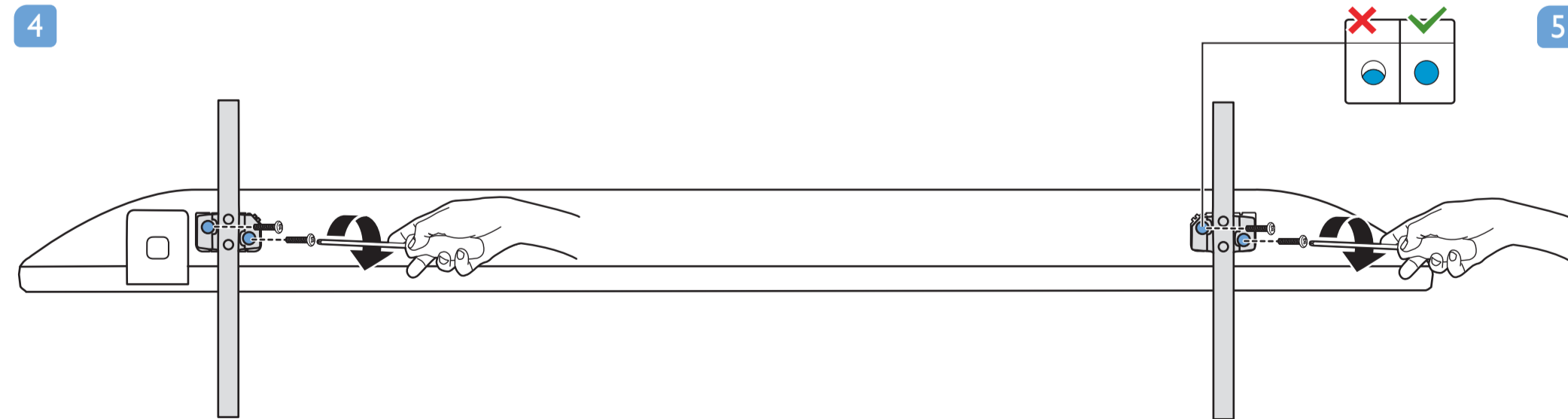

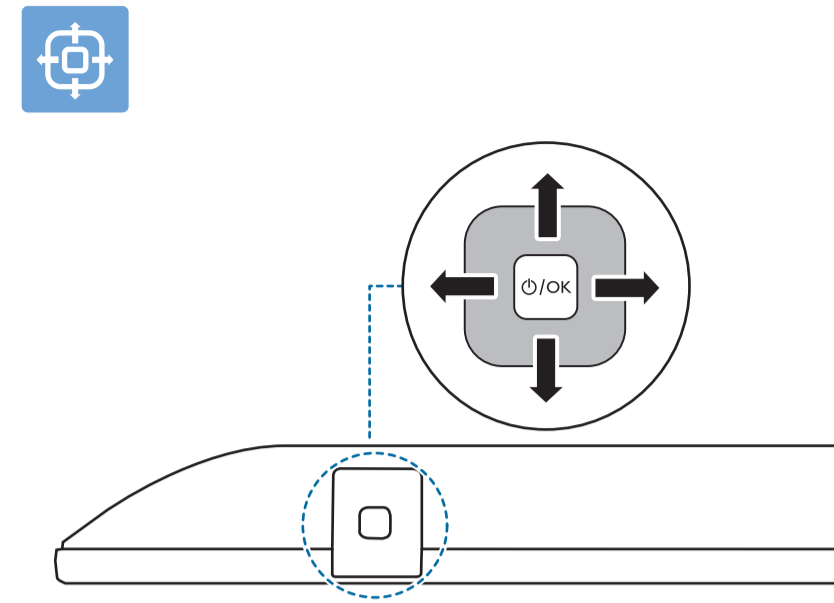
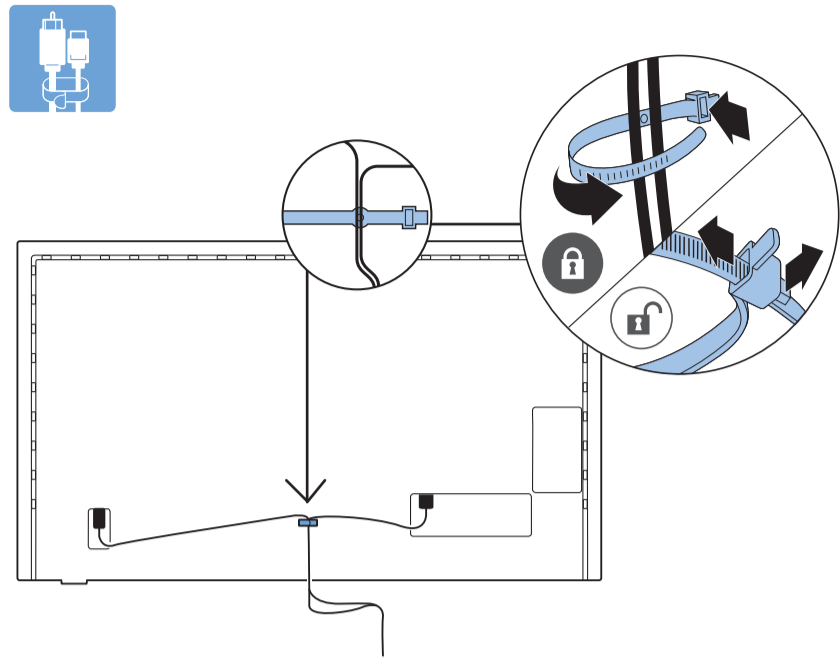

English Read the safety instructions.
Türkçe Güvenlik talimatlarını okuyun.



Register your product and get support at
www.philips.com/TVsupport

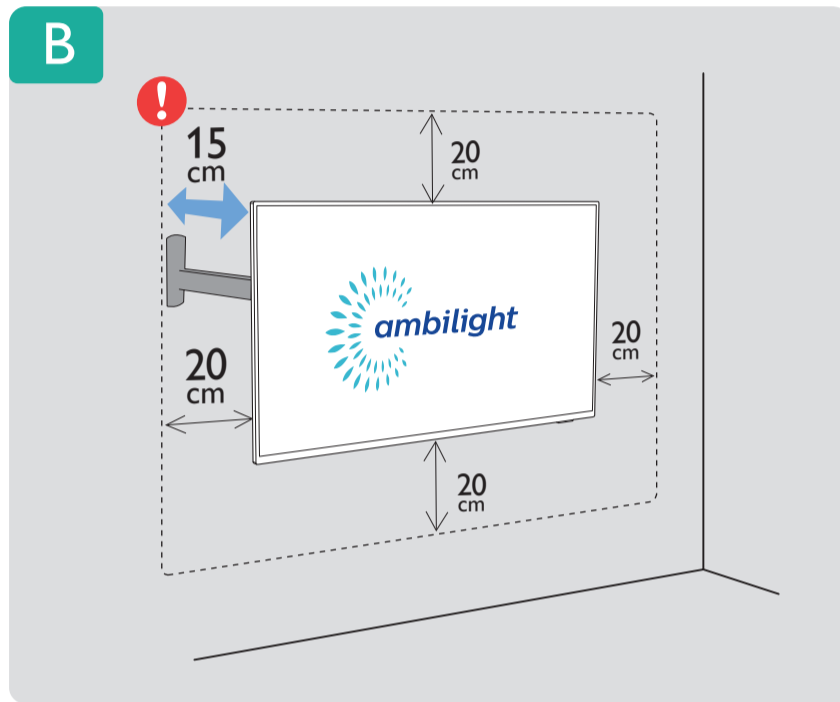
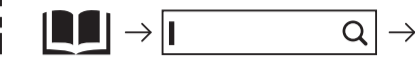

VESA (x, y)
50" 300 x 200mm M6 (L: 10 mm-16 mm)
126 cm

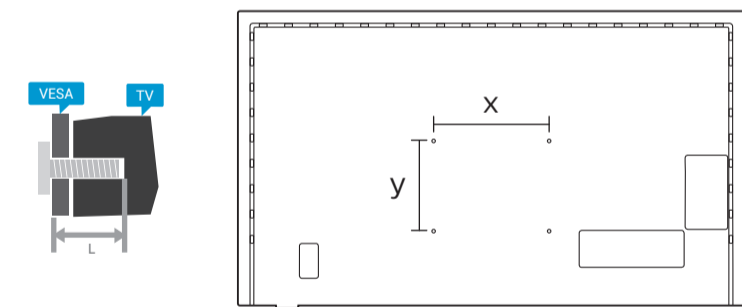

1



2

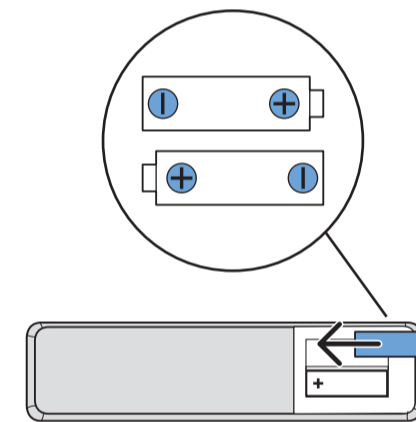

3



2x AAA LR03 1.5V

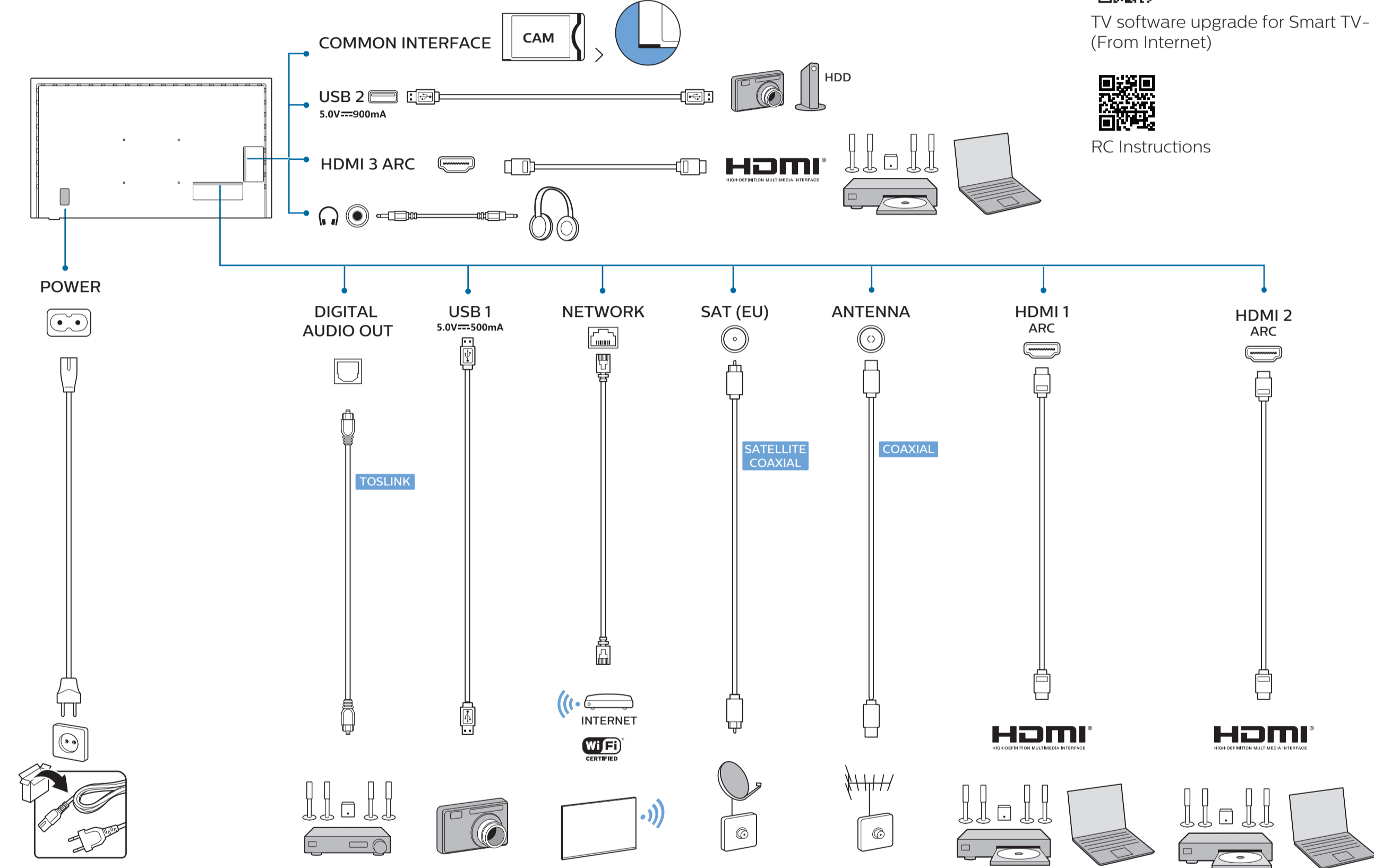
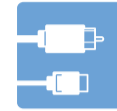

TV software upgrade for Smart TV-
(From Internet)



RC Instructions

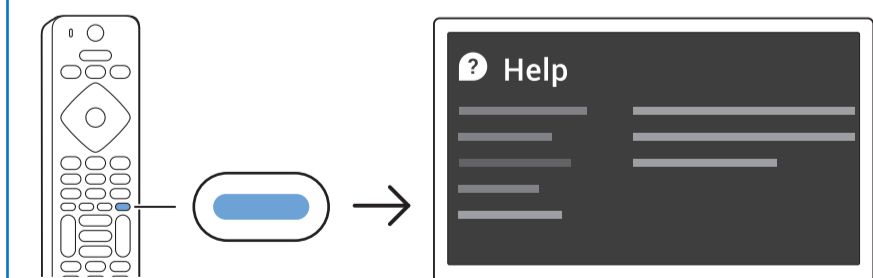
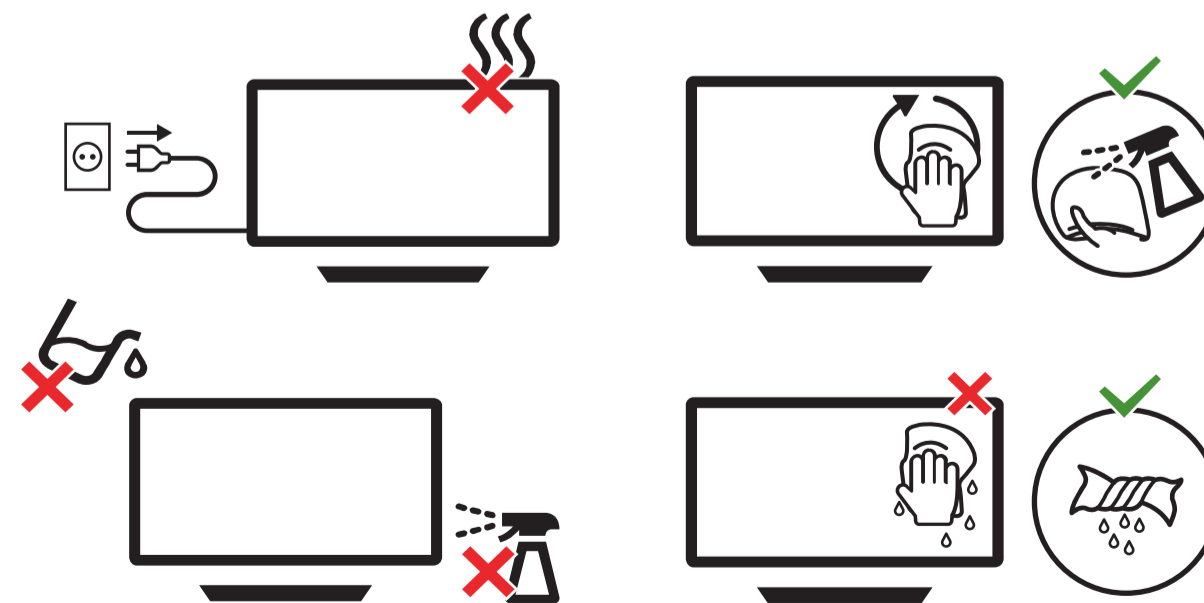
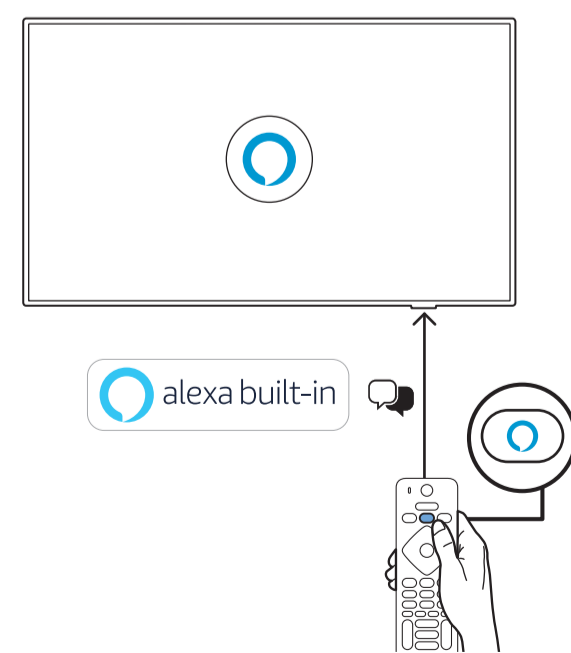
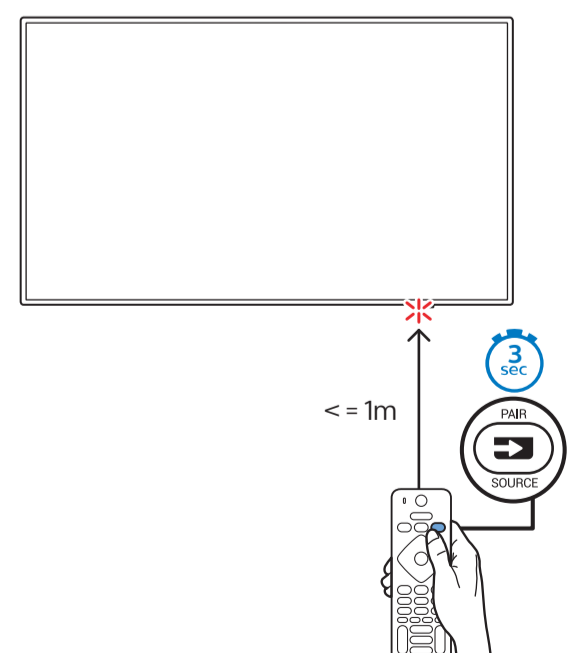

All registered and unregistered trademarks are property of their respective owners. Specifications are subject to change without notice. Philips and the Philips' shield emblem are trademarks of Koninklijke Philips N.V. and are used under license from Koninklijke Philips N.V. 2020 © TP Vision Europe BV. All rights reserved. philips.com