

20PFL4112S

FLAT TV



www.philips.com/support

EN

USER MANUAL

PHILIPS

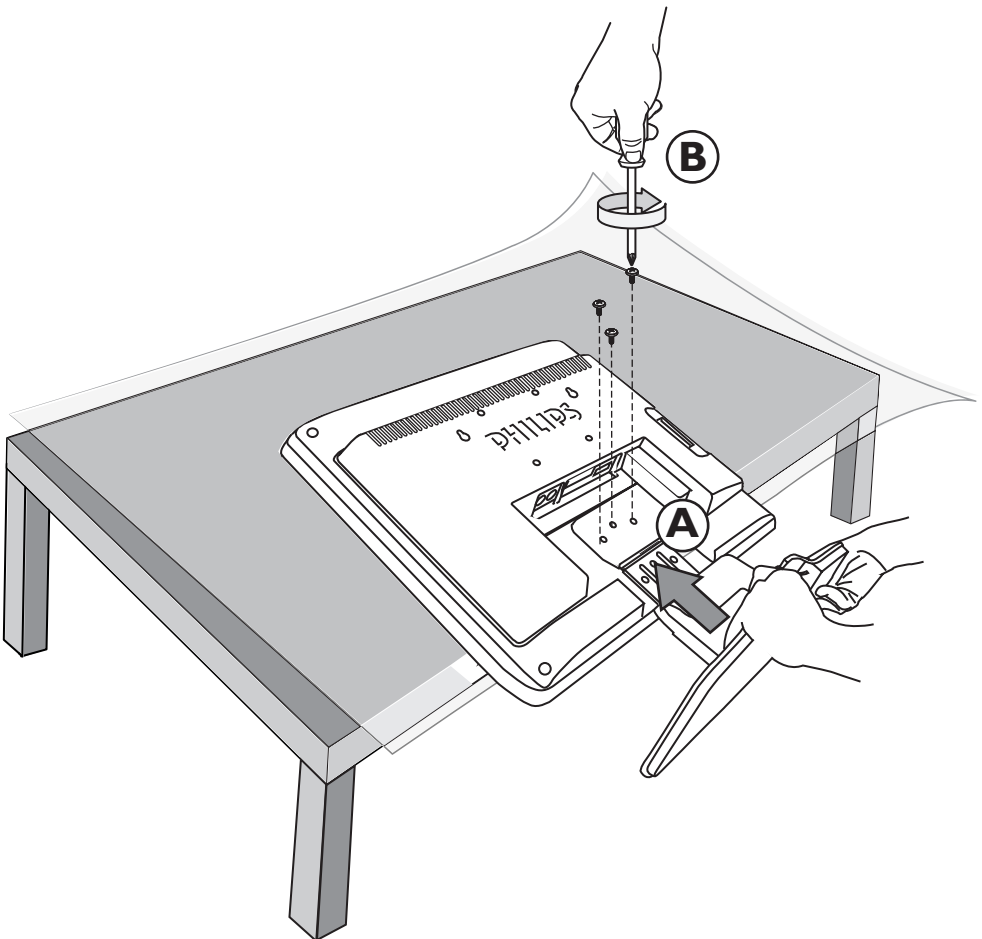
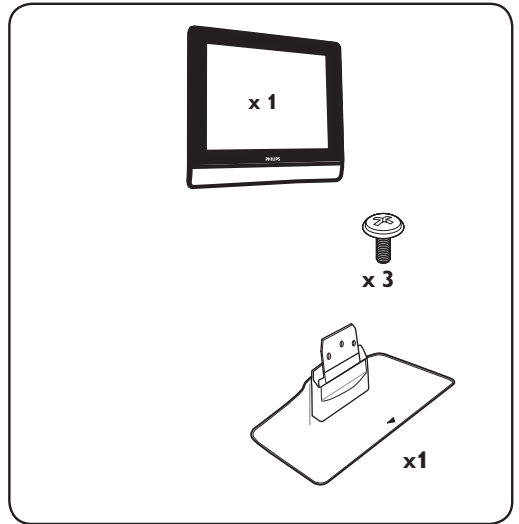
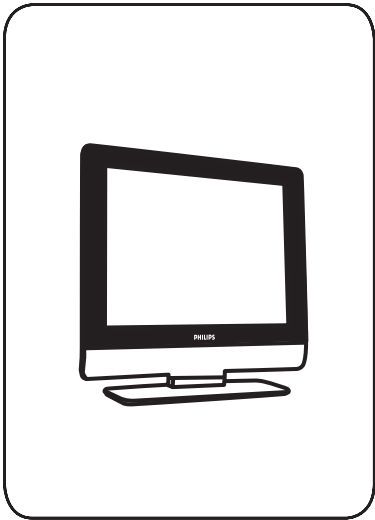

Please be aware that when you mount your TV on the wall using the key hole system, the side Audio/Video connectors are difficult to access and use when connecting standard cables.

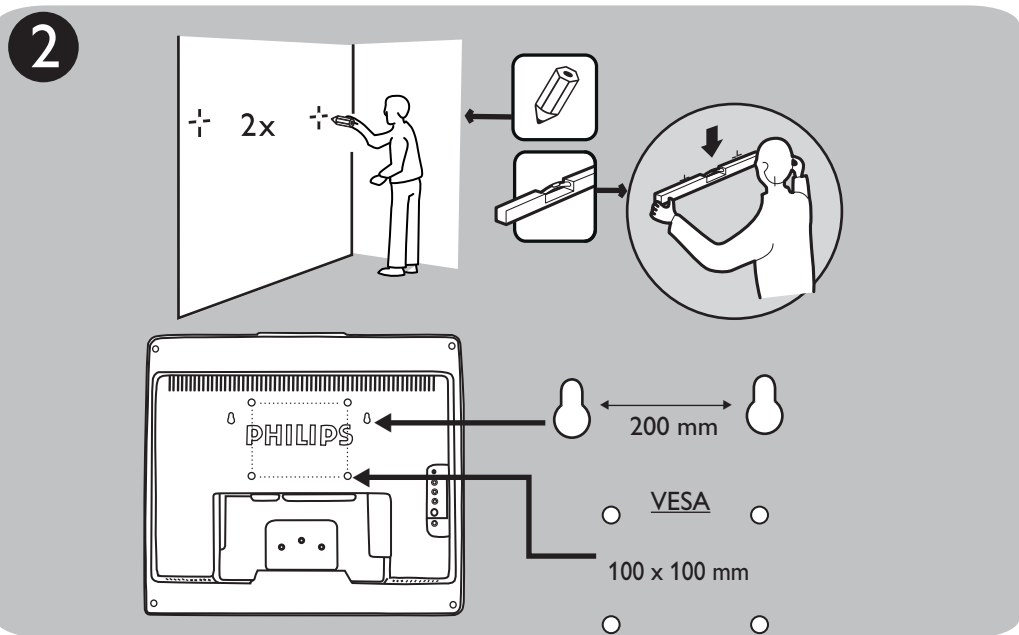
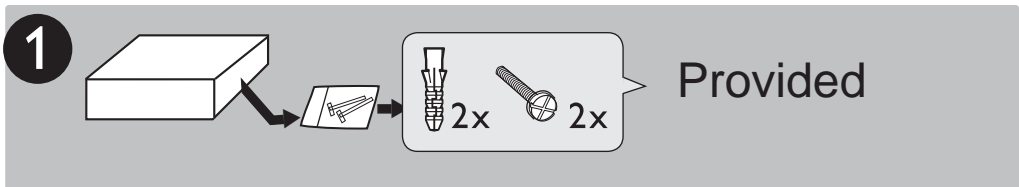

3

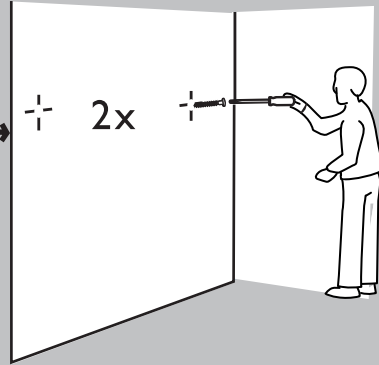
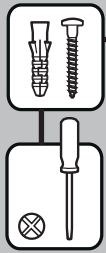
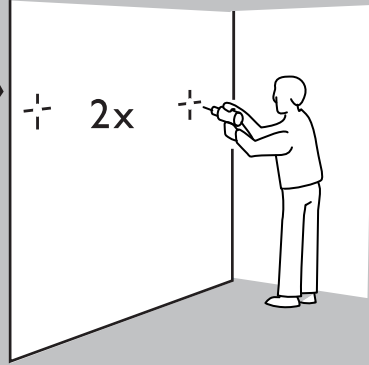
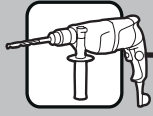

4

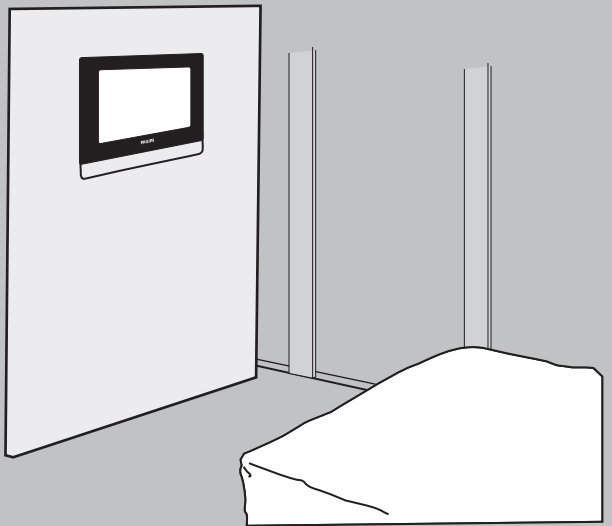
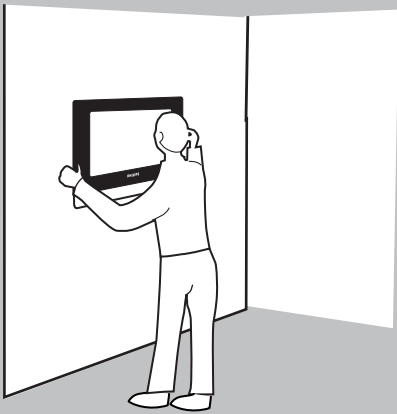

Important information

Stationary images on the TV screen

A characteristic of LCD and Plasma Panels is that displaying the same image for a long time can cause a permanent after-image to remain on the screen. This is called phosphor burn in. Normal use of the TV should involve the showing of pictures that contain constantly moving and changing images that fill the screen.

Examples of stationary images (this is not an all inclusive list, you may encounter others in your viewing).

- TV and DVD menus: listings of DVD disk content.
- Black bars: when black bars appear at the left and right side of the screen, it is recommended to change to a picture format so that the picture fills the entire screen;
- TV channel logo: present a problem if they are bright and stationary. Moving or low-contrast graphics are less likely to cause uneven aging of the screen;
- Stock market stickers: presented at the bottom of the TV screen;
- Shopping channel logos and pricing displays: bright and shown constantly or repeatedly in the same location on the TV screen.
- Examples of still pictures also include logos, computer images, time display, teletext and images displayed in 4:3 mode, static images or characters, etc.

Tip:

Reduce contrast and brightness when viewing.

Electric, Magnetic and Electromagnetic Fields (“EMF”)

- Philips Royal manufactures and sells many products targeted at consumers, which, like any electronic apparatus, in general have the ability to emit and receive electro magnetic signals.
- One of Philips’ leading Business Principles is to take all necessary health and safety measures for our products, to comply with all applicable legal requirements and to stay well within the EMF standards applicable at the time of producing the products.
- Philips is committed to develop, produce and market products that cause no adverse health effects.
- Philips confirms that if its products are handled properly for their intended use, they are safe to use according to scientific evidence available today.
- Philips plays an active role in the development of international EMF and safety standards, enabling Philips to anticipate further developments in standardisation for early integration in its products.

Introduction

Thank you for purchasing this television set.
This handbook has been designed to help you install and operate your TV set.
We would strongly recommend that you read it thoroughly.

Table of Contents

Installation	
Presentation of the LCD Television	2
Remote control	2
Remote control keys	3-4
Installing your television set	5
Quick installation	5
Program sort	6
Manual store	6
Other settings in the Install menu	6
Operation	
Picture settings	7
Sound adjustments	7
Feature settings	7
Screen Formats	8
Teletext	9
Using the radio	10
Using in PC monitor mode	10
Using in HD (High Definition) Mode	11
Peripherals	
Video recorder	12
Other equipment	13
Side connections	13
HD equipment	13
Computer	13
Practical information	
Tips	14
Glossary	14

Recycling



The packaging of this product is intended to be recycled. Apply to the local authorities for correct disposal.

Disposal of your old product.

Your product is designed and manufactured with high quality materials and components, which can be recycled and reused. When this crossed-out wheeled bin symbol is attached to a product it means the product is covered by the European Directive 2002/96/EC. Please inform yourself about the local separate collection system for electrical and electronic products.



Please act according to your local rules and do not dispose of your old products with your normal household waste. The correct disposal of your old product will help prevent potential negative consequences for the environment and human health.

Presentation of the LCD Television

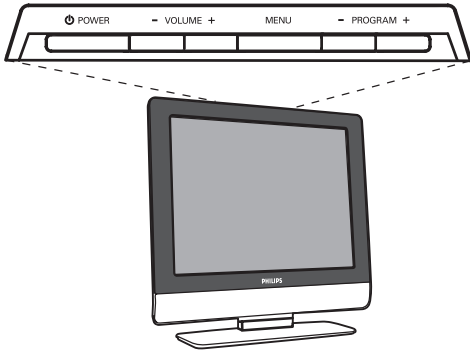

1 Television keys:

- **POWER:** to switch the TV on or off.
- **VOLUME +/-:** to adjust sound level.
- **MENU:** to access or close menus.
The PROGRAM +/- keys can be used to select an adjustment and the VOLUME +/- keys to make that adjustment.
- **PROGRAM +/- (- P +):** to select programmes.

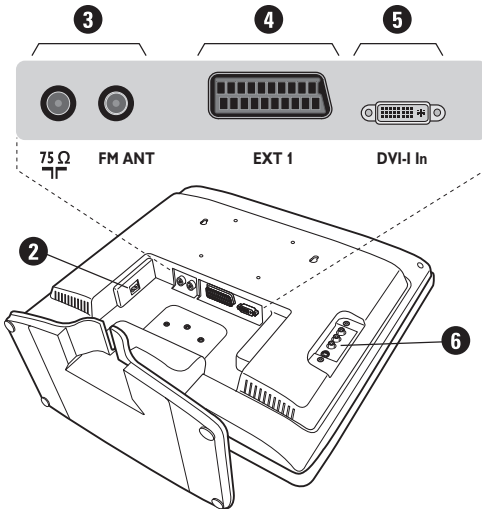

Rear of set :

The main connections are made at the bottom of the television.

For more details on connections see page 12.



Do not remove the protective sheet until you have completed the stand/wall mounting and connections

- 2 Power socket
- 3 TV and radio aerial sockets
- 4 EXT1 socket
- 5 DVI-I input for connecting a HD (high definition)* equipment or computer with DVI output.
- 6 Side connections

* Depending on version.

Remote control

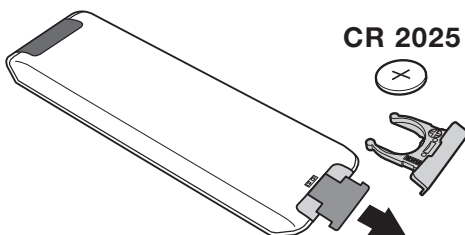

Pull out the plastic insulation sheet from the battery, this will activate the remote control. The battery supplied with the appliance does not contain mercury or nickel cadmium so as to protect the environment. Please do not discard your used batteries, but use the recycling methods available (consult your distributor).

Remote Control Keys for LCD TV Functions

- 1) **⏻ (STANDBY)**
To set the TV to standby mode. To switch the TV set on again, press **P -/+**, **0** to **9** or **AV** keys.
- 2) **Sleeptimer**
To select the length of time before the set automatically switches to standby (from 0 to 240 minutes)
- 3) **AV**
To display **Source List** to select **TV** or peripheral equipment connected to **EXT1**, **AV/S-VHS**, **PC**, **HD** or **Radio** (p. 12).
- 4) **Teletext keys (p. 9)**
- 5) *Unused key.*
- 6) **MENU**
To call up or exit the TV menus.
- 7) **Screen Format (p. 8)**
- 8) **Cursor (⏪ ⏩ ⏴ ⏵)**
These 4 keys are used to move around the menus.
- 9) **Volume**
To adjust the sound level.
- 10) **Smart picture and sound**
Used to access a series of predefined picture and sound settings.
The personal position relates to settings selected from the menus.
- 11) **i+ Screen information**
To display / remove the programme number, the time, the sound mode and the time remaining on the timer. Hold down for 5 seconds to permanently display the programme number on the screen.

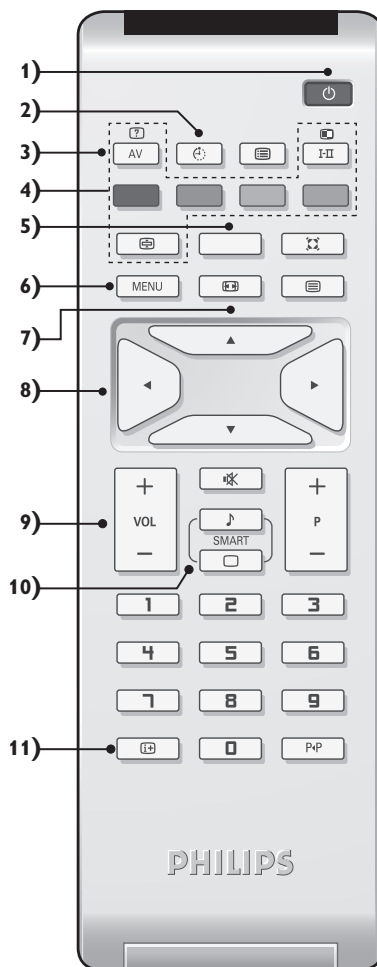

Remote Control Keys for LCD TV Functions

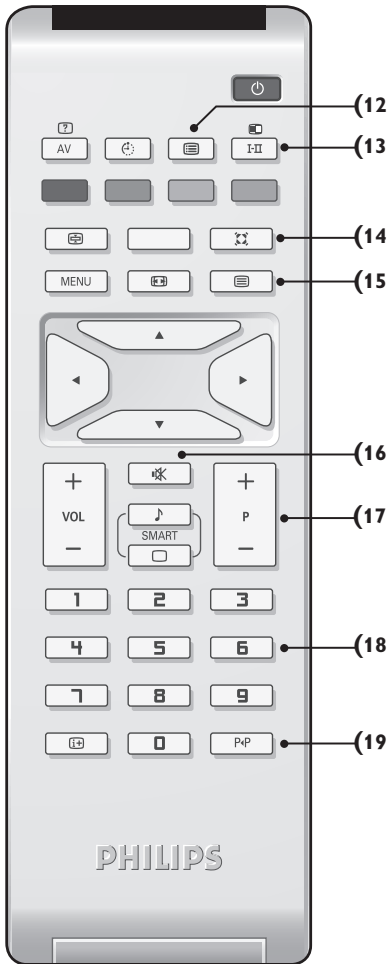

12) List of programmes

To display / clear the list of programmes. Use the keys $\wedge \vee$ to select a programme and the key $\>$ to display it.

13) I-II Sound mode

Used to force programmes in **Stereo** and **Nicam Stereo** to **Mono** or, for bilingual programmes, to choose between **Dual I** or **Dual II**.

*The **Mono** indication is red when in forced position.*

14) Surround Sound

To activate / deactivate the surround sound effect. In stereo, this gives the impression that the speakers are further apart. For models equipped with Virtual Dolby Surround[®], you can experience Dolby Surround Pro Logic sound effects.

15) Teletext (p. 9)

16) Mute

To mute or restore the sound.

17) Selecting TV programmes

To move up or down a programme. The number and the sound mode are displayed for a few seconds.

For some TV programmes the title of the programme appears at the bottom of the screen.

18) Numerical keys

For direct access to programmes. For a 2 digit programme number, the 2nd digit must be entered before the dash disappears.

19) Previous programme

To access the previously viewed programme.

** Manufactured under license from Dolby Laboratories. "Dolby" and the double-D symbols are trademarks of Dolby Laboratories.*

Installing your television set

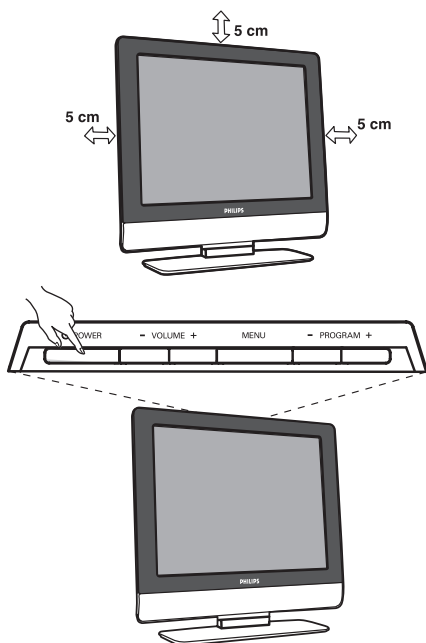

Please handle with care and wipe with a soft cloth to ensure your TV keeps looking new.

1 Positioning the television set

Place your TV on a solid stable surface. To avoid danger do not expose the TV to water, or a heat source (e.g. lamp, candle, radiator). Do not obstruct the ventilation grid at the rear.

2 Connecting the aerials

- Insert the radio aerial lead into the FM ANT socket located at the rear of the TV.
- Insert the aerial plug into the  socket at the rear of the set.
- Connect the power lead to the television and the mains plug into the wall socket (220-240V/50 Hz).

• Ensure the power cord is fully inserted in the TV mains socket and the wall socket.
For connecting other appliances see page p.12.

3 Switching on

To switch on the set, press the **POWER** key. A green indicator comes on and the screen lights up. Go straight to the Quick Installation chapter. If the TV remains in standby mode (red indicator), press the **P -/+** key on the remote control.

The indicator will flash when you use the remote control.

Plug & Play

Quick installation

When you turn on the TV set for the first time, a menu is displayed on screen. This menu prompts you to select the country and language for the menus:

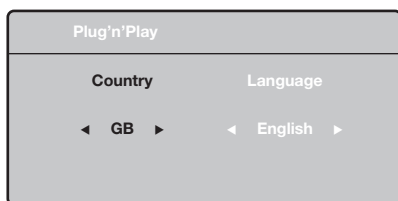

If the menu is not displayed, press the **MENU** key to display the menu.

- 1 Use the **^** **v** keys on the remote control to select your country and validate with **>**.
If your country does not appear in the list, select choice "..."
- 2 Next select your language using the **^** **v** keys and validate with **>**.

- 3 The search starts automatically. All the available TV programmes and radio stations will be stored. This operation takes a few minutes. The display shows the progress of the search and the number of programs found. At the end of the search, the menu disappears.

To exit or interrupt the search, press **MENU**. If no programme is found, consult the possible solutions p. 14.

- 4 If the transmitter or cable network sends the automatic sort signal, the programs will be numbered correctly. In this case, the installation is complete.
- 5 If this is not the case, you need to use the **Sort** menu to number the programs correctly.
Some transmitters or cable networks broadcast their own sort parameters (region, language, etc.). In this case, indicate your choice using the **^** **v** keys and validate with **>**.

Program sort

- 1 Press the **MENU** key. The **TV Menu** is displayed on the screen.

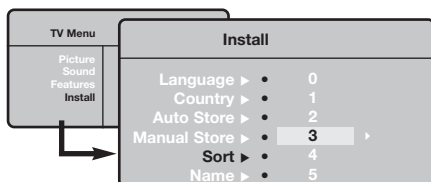

- 2 With the cursor, select the **Install** menu followed by the **Sort** menu.
- 3 Select the programme you want to move using the $\wedge \vee$ keys and press \triangleright .
- 4 Then use the $\wedge \vee$ keys to select the new number and validate with \triangleleft .
- 5 Repeat steps 3 and 4 for each programme you wish to renumber.
- 6 To quit the menus, press **i+**.

Manual store

This menu is used to store the programmes one at a time.

- 1 Press the **MENU** key.
- 2 With the cursor, select the **Install** menu then **Manual store**:

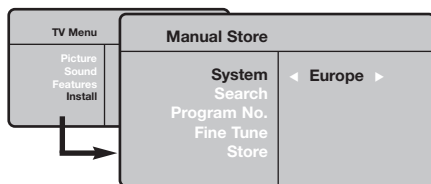

- 3 **System:** select **Europe** (automatic detection*) or **Western Europe** (BG standard), **Eastern Europe** (DK standard), **United Kingdom** (I standard) or **France** (LL' standard).

* Except for France (LL' standard), you must select choice **France**.

- 4 **Search:** press \triangleright . The search starts. Once a programme is found, the scanning stops and its name is displayed (when available). Go to the next step. If you know the frequency of the required programme, this can be entered directly using the **0 to 9** keys.
If no picture is found, consult the possible solutions (p. 14).
- 5 **Program No.:** enter the required number with the $\langle \rangle$ or **0 to 9** keys.
- 6 **Fine Tune:** if the reception is not satisfactory, adjust using the $\langle \rangle$ keys.
- 7 **Store:** press \triangleright . The program is stored.
- 8 Repeat steps 4 to 7 for each programme to store.
- 9 To quit the menus, press **i+**.

Other settings in the Install menu

- 1 Press the **MENU** key and select the **Install** menu:
- 2 **Language:** to change the display language for the menus.
- 3 **Country:** to select your country (**GB** for Great Britain).

This setting is used for the search, automatic programme sort and teletext display. If your country does not appear in the list, select "..."

- 4 **Auto Store:** to start automatic search for all programmes available in your region. If the transmitter or cable network sends the automatic sort signal, the programmes will be numbered correctly. If this is not the case, you need to use the Sort menu to renumber the programmes.

*Some transmitters or cable networks broadcast their own sort parameters (region, language, etc.). In this case, indicate your choice using the $\wedge \vee$ keys and validate with \triangleright . To quit or interrupt the search, press **MENU**. If no picture is found, consult the possible solutions (p. 14).*

- 5 **Name:** If required, you can give a name to the programmes and external connectors. Use the $\langle \rangle$ keys to move around the name display area (5 characters) and the $\wedge \vee$ keys to select the characters. When the name has been entered, use the \triangleleft key to exit. The name is stored.
Note: on installation, the programs are named automatically when an identification signal is sent.
- 6 To quit the menus, press **i+**.

Picture settings

- 1 Press **MENU** then **>**. The **Picture** menu is displayed:

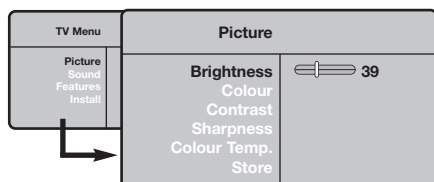

- 2 Use the **^** **v** keys to select a setting and the **<** **>** keys to adjust.
- 3 Once the adjustments have been made, select

Store and press **>** to store them. Press **i+** to exit.

Description of the adjustments:

- **Brightness:** this changes picture brilliance.
- **Colour:** this changes the intensity of the colour.
- **Contrast:** this changes the difference between the light and dark tones.
- **Sharpness:** this changes the picture definition.
- **Colour Temp.:** this changes the colour rendering: **Cold** (bluer), **Normal** (balanced) or **Warm** (redder).
- **Store:** to store the picture adjustments and settings.

Sound adjustments

- 1 Press **MENU**, select **Sound** (**v**) and press **>**. The **Sound** menu is displayed:

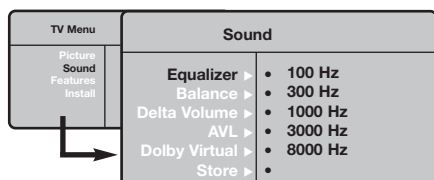

- 2 Use the **^** **v** keys to select a setting and the **<** **>** keys to adjust.
- 3 Once the adjustments have been made, select **Store** and press **>** to store these changes.
- 4 To quit the menus, press **i+**.

Description of the settings:

- **Equalizer:** to adjust the sound tone (from bass: 100 Hz to treble: 8000 Hz).
- **Balance:** this balances the sound on the left and right speakers.
- **Delta Volume:** this is used to compensate any volume discrepancies between the different programs or EXT sockets. This setting is available for programs 0 to 40 and the EXT sockets.
- **AVL (Automatic Volume Leveller):** this is used to limit increases in sound, especially on program change or advertising slots.
- **Dolby Virtual:** To activate / deactivate the surround sound effect. *You can also access these settings with key .*
- **Store:** this is used to store the sound settings.

Feature settings

- 1 Press **MENU**, select **Features** (**v**) and press **>**. You can adjust:
- 2 **Contrast +:** automatic adjustment of the picture contrast which permanently sets the darkest part of the picture to black.

- 3 **Sleep :** to select an automatic standby period.
- 4 To quit the menus, press **i+**.

Screen Formats

The pictures you receive may be transmitted in 16:9 format (wide screen) or 4:3 format (conventional screen). 4:3 pictures sometimes have a black band at the top and bottom of the screen (letterbox format). This function allows you to optimise the picture display on screen.

If your television is equipped with a 4:3 screen.

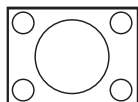

Press the  key (or $\wedge \vee$) to select the different modes:

4:3

The picture is reproduced in 4:3 format.

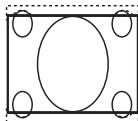

Expand 4:3

The picture is enlarged vertically. This mode is used to cancel the black bands when watching a programme in letterbox format.

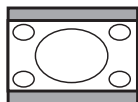

Compress 16:9

The picture is compressed vertically into 16:9 format.

If your television is equipped with a 16:9 screen.

Press the  key (or $< >$) to select the different modes:

This TV set is also equipped with automatic switching which will select the correct-screen format, provided the specific signals are transmitted with the programmes.

4:3

The picture is reproduced in 4:3 format and a black band is displayed on either side of the picture.

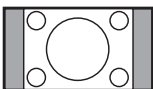

Zoom 14:9

The picture is enlarged to 14:9 format, a thin black band remains on both sides of the picture.



Zoom 16:9

The picture is enlarged to 16:9 format. This mode is recommended when displaying pictures which have black bands at the top and bottom (letterbox format).

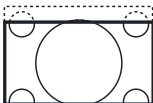

Subtitle Zoom

This mode is used to display 4:3 pictures using the full surface of the screen leaving the sub-titles visible.

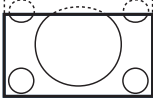

Super Wide

This mode is used to display 4:3 pictures using the full surface of the screen by enlarging the sides of the picture.

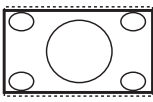

Widescreen

This mode restores the correct proportions of images transmitted in 16:9.

Note: If you display a 4:3 picture in this mode, it will be enlarged horizontally.

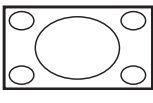

Teletext

Teletext is an information system broadcast by certain channels which can be consulted like a newspaper. It also offers access to subtitles for viewers with hearing problems or who are not familiar with the transmission language (cable networks, satellite channels, etc.).



Press :

You will obtain :

Teletext call This is used to call or exit teletext mode. The summary appears with a list of items that can be accessed. Each item has a corresponding 3 digit page number.
If the channel selected does not broadcast teletext, the indication 100 will be displayed and the screen will remain blank (in this case, exit teletext and select another channel).



Selecting a page Enter the number of the page required using the 0 to 9 or P +/- keys. Example: page 120, enter 120. The number is displayed top left, the counter turns and then the page is displayed. Repeat this operation to view another page.
If the counter continues to search, this means that the page is not transmitted. Select another number.



Direct access to the items Coloured areas are displayed at the bottom of the screen. The 4 coloured keys are used to access the items or corresponding pages.
The coloured areas flash when the item or the page is not yet available.





Contents This returns you to the contents page (usually page 100).



Stop sub-page acquisition Certain pages contain sub-pages which are automatically displayed successively. This key is used to stop or resume sub-page acquisition. The indication  appears top left.



Double page teletext To activate or deactivate the double page teletext display mode. The active page is displayed on the left and the following page is displayed on the right. Press  if you want to hold a page (i.e. the contents page). The active page is then displayed on the right. To return to normal mode, press .
(depending on version)



Hidden information To display or hide the concealed information (games solutions).



Enlarge a page This allows you to display the top or bottom part of the page and then return to normal size.

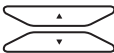

Favourite pages Instead of the standard coloured areas displayed at the bottom of the screen, you can store 4 favourite pages on the first 40 channels which can then be accessed using the coloured keys (red, green, yellow, blue). Once set, these favourite pages will become the default every time teletext is selected.



- 1 Press the **MENU** key to change to favourite pages mode.
- 2 Display the teletext page that you want to store.
- 3 Press the coloured key of your choice for 3 seconds. The page is now stored.
- 4 Repeat the operation with the other coloured keys.
- 5 Now when you consult teletext, your favourite pages will appear in colour at the bottom of the screen. To temporarily retrieve the standard items, press **MENU**.
To clear everything, and return the standard items as the default, press  for 5 seconds.

Using the radio

Choosing radio mode

- 1 Press the **AV** key on the remote control to display the **Source List**.
- 2 Use the cursor \wedge/\vee key to select **FM Radio** and then press the cursor $>$ key to switch the TV to radio mode.

To return to TV mode, press the **AV** key, select **TV** and validate with $>$ key.

In radio mode the number and name of the station (if available), its frequency and the sound mode are indicated on the screen.

Selecting programmes

Use the **0/9** or **P +/-** keys to select the FM stations (from 1 to 40).

List of radio stations

Press the  key to display / hide the list of radio stations. Then use the cursor to select a station.

Using the radio menus

Use the **MENU** key to access the specific radio settings.

Searching radio stations

If you have used the quick installation all the available FM stations will be stored. To start a new search use the **Install** menu : **Auto Store** (for a complete search) or **Manual Store** (for a station by station search). These menus work in exactly the same way as the TV menus.

Screen saver

In the **Features** menu you can activate / close the screen saver. The time, the frequency of the station and its name (if available) move across the screen.

Using in PC monitor mode

NOTE

- When using the LCD TV as a PC monitor, slight diagonal interference lines may be observed when it is operated under electromagnetic interference environment but will not affect the performance of this product.
- For better performance, good quality DVI cable with good noise isolation filter is recommended.

PC Mode

Your TV can be used as a computer monitor.
You must first of all connect the computer and adjust the resolution (see p.13).

Choosing PC mode

- 1 Press the **AV** key on the remote control to display the **Source List**.
- 2 Use the cursor \wedge/\vee key to select **PC** and then press the cursor $>$ key to switch the TV to PC mode (**DVI-I In**).
To return to TV mode, press the **AV** key, select **TV** and validate with $>$ key.

Using the PC menus

Press the **MENU** key to access the specific settings of the PC monitor mode. Use the cursor to adjust them (the settings are automatically saved):

• Picture:

- **Brightness / Contrast** : to adjust the brightness and contrast.
- **Horizontal / Vertical**: to adjust the horizontal and vertical placing of the image.
- **Colour Temp**: to adjust the colours (cold, normal or warm).

• **Audio Selection**: to choose the sound reproduced on the TV (**PC/HD, TV or Radio**).

• **Features** (only available on certain versions):

- **Phase/Clock**: eliminates the horizontal (**Phase**) and vertical (**Clock**) interfering lines.
- **Format** : to choose between full screen or native format of the PC screens.
- **Auto Adjust**: position is set automatically.
- **Reset To Factory Setting**: to return to the factory settings (default settings).

Using in HD (High Definition) Mode

(Only available on certain versions)

HD Mode

The HD (High Definition) mode allows you to enjoy clearer and sharper pictures through the DVI-I inputs if you are using a HD receiver/ equipment that can transmit high definition programming.

You must first of all connect the HD equipment (see p.13).

Choosing HD mode

- 1 Press the **AV** key on the remote control to display the **Source List**.
- 2 Use the cursor \wedge/\vee key to select **HD** and then press the cursor $>$ key to switch the TV to HD mode.
To return to TV mode, press the **AV** key, select **TV** and validate with $>$ key.

Using the HD menus

Press the **MENU** key to access the specific settings of the HD mode. Use the cursor to adjust them (the settings are automatically saved):

Picture:

- **Brightness:** this changes picture brilliance.
- **Colour:** this changes the intensity of the colour.
- **Contrast:** this changes the difference between the light and dark tones.
- **Sharpness** (only available for certain signal only): this changes the picture definition.

- **Colour Temp.:** this changes the colour rendering: **Cold** (bluer), **Normal** (balanced) or **Warm** (redder).
- **Store:** to store the picture adjustments and settings.

Sound:

- **Equalizer:** to adjust the sound tone (from bass: 100 Hz to treble: 8000 Hz).
- **Balance:** this balances the sound on the left and right speakers.
- **Delta Volume:** this is used to compensate any volume discrepancies between the different programs or EXT sockets. This setting is available for programs 0 to 40 and the EXT sockets.
- **AVL** (Automatic Volume Leveller): this is used to limit increases in sound, especially on program change or advertising slots.
- **Dolby Virtual:** To activate / deactivate the surround sound effect. You can also access these settings with key .
- **Store:** this is used to store the sound settings.

Features:

- **Sleep :** to select an automatic standby period.
- **Horizontal :** to adjust the horizontal placing of the image.

Here is the list of the different HD display resolutions available on your TV:

	15"/39cm XGA		20"/51cm VGA		20"/51cm WXGA		23"/58cm WXGA	
	Analogue	Digital	Analogue	Digital	Analogue	Digital	Analogue	Digital
SDTV 480 i	X		X		X		X	
SDTV 576 i	X		X		X		X	
EDTV 480 p	X	X	X	X	X	X	X	X
EDTV 576p	X	X	X	X	X	X	X	X
HDTV 720p	X	X	X		X	X	X	X
HDTV 1080 i	X	X			X	X	X	X

Connecting peripheral equipment

The television has 1 external socket situated at the back of the set (EXT1) and sockets on the side. Press the **AV** key on the remote control to display **Source List** and select **TV** or peripheral equipment connected to **EXT1, AV/SVHS, PC, HD** or **Radio**.

The **EXT1** socket has audio, CVBS/RGB inputs and audio, CVBS outputs.

The side connections has audio inputs, CVBS/S-VHS inputs, headphone out.

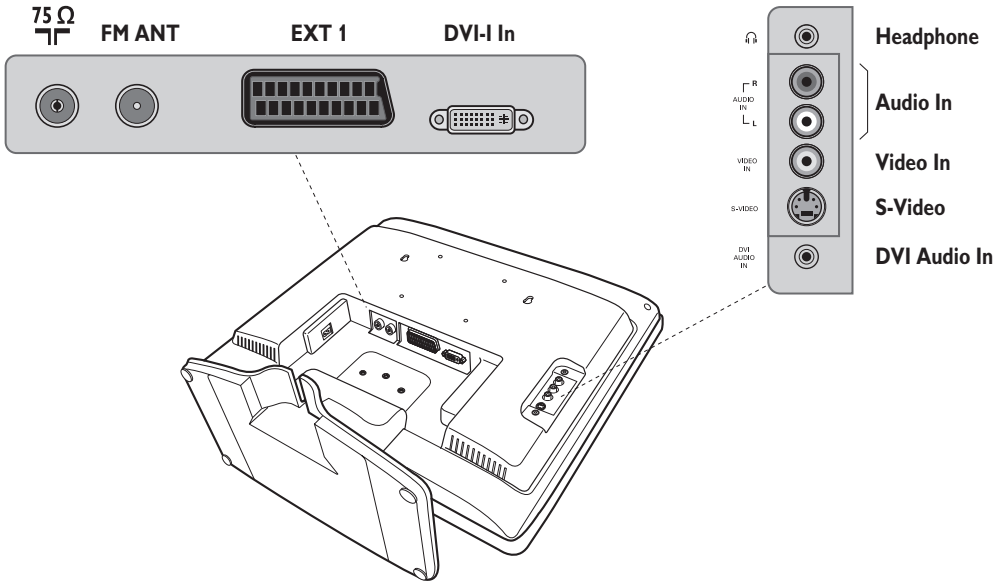

Video recorder

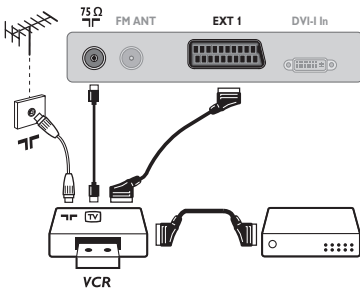

Carry out the connections shown opposite, using a good quality euroconnector cable.

If your video recorder does not have a euroconnector socket, the only connection possible is via the aerial cable. You will therefore need to tune in your video recorder's test signal and assign it programme number 0 (refer to manual store, p. 6).

*To reproduce the video recorder picture, press **0** key.*

Video recorder with decoder

Connect the decoder to the second euroconnector socket of the video recorder. You will then be able to record scrambled transmissions.

Other equipment

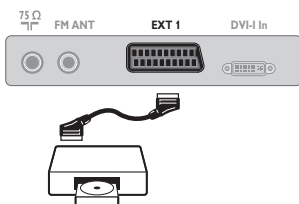

Satellite receiver, decoder, CDV, games, etc.

Carry out the connections shown opposite.

Side connections

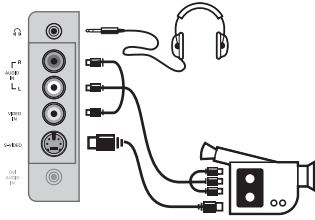

Make the connections as shown opposite.

With the **AV** key, select **AV/S-VHS**.

For a mono set, connect the sound signal to the **AUDIO L** (or **AUDIO R**) input. The sound automatically comes out of the left and right speakers of the set.

Headphones

When headphones are connected, the sound on the TV set will be cut. The **VOLUME +/-** keys are used to adjust the volume level.

The headphone impedance must be between 32 and 600 Ohms.

I-I)

HD equipment

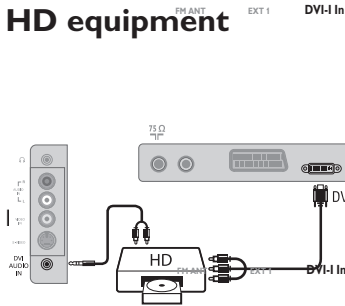

Make the connections as shown opposite.

With the **AV** key, select **HD**.

For more information on using HD mode see page 11.

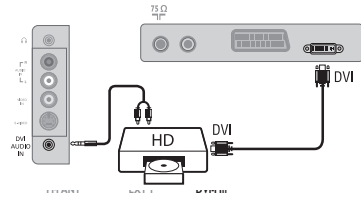

Computer

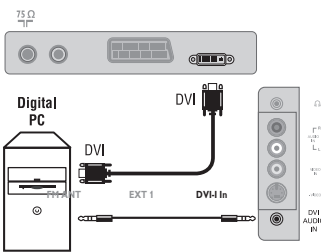

PC with DVI

Connect the monitor output (DVI) of your computer to the DVI-I In of the LCD TV. Connect the sound output Audio out of the computer to the input DVI Audio in of the LCD TV.

PC with VGA

Connect the monitor output (VGA) of your computer via a VGA/DVI-I cable* to the DVI-I In of the TV. Connect the sound output Audio out of the computer to the input DVI Audio in of the LCD TV.

* Not supplied with the set.

For more information on using PC mode see page 10.

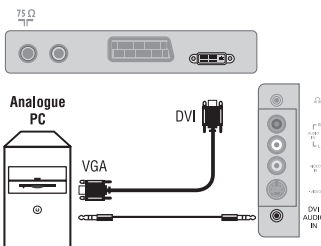

Configure the computer for optimum resolution on :

20PF4112S : 640 x 480, 75 Hz

Tips

Poor reception	The proximity of mountains or high buildings may be responsible for ghost pictures, echoing or shadows. In this case, try manually adjusting your picture: see Fine Tune (p. 6) or modify the orientation of the outside aerial. If you are using an indoor aerial, reception may be difficult in certain conditions. You can improve reception by rotating the aerial. If the reception remains poor, you will need to use an external aerial
No picture	Have you connected the aerial socket properly? Have you chosen the right system? (p. 6). Poorly connected euroconnector cables or aerial sockets are often the cause of picture or sound problems (sometimes the connectors can become half disconnected if the TV set is moved or turned). Check all connections.
No sound	If on certain channels you receive a picture but no sound, this means that you do not have the correct TV system. Modify the System setting (p. 6). The amplifier connected to the TV does not deliver any sound? Check that you have not confused the audio output with the audio input.
PC mode doesn't work ?	Check that you have configured the computer on a compatible display resolution (see p. 13).
Snowy picture when switched to HD-D mode	Noise is displayed if the connected digital equipment's (DVD player or set-top box) HDCP authentication failed. Check the user manual for the digital equipment you are connecting.
Remote control	The TV set does not react to the remote control; the indicator on the set no longer flashes when you use the remote control? Replace the battery.
Standby	If the set receives no signal for 15 mins, it automatically goes into standby mode. To save power, your set is fitted with components that give it a very low power consumption when in standby mode (less than 1 W).
Cleaning the set	Only use a clean, soft and lint-free cloth to clean the screen and the casing of your set. Do not use alcohol-based or solvent-based products.
Still no results?	Disconnect the mains plug of the TV for 30 seconds then reconnect it. If your TV set breaks down, never attempt to repair it yourself: contact your dealer's after-sales service.

Glossary

DVI (Digital Visual Interface): A digital interface standard created by the Digital Display Working Group (DDWG) to convert analog signals into digital signals to accommodate both analog and digital monitors.

HDCP (High-bandwidth Digital-Content Protection): developed by Intel to provide secure copy protection of content transmitted digitally from the source (such as DVD player or set-top box) to the TV display.

RGB signals : These are the three video signals, Red Green Blue, which make up the picture. Using these signals improves picture quality.

S-VHS Signals: These are 2 separate Y/C video signals from the S-VHS and Hi-8 recording standards. The luminance signals Y (black and white) and chrominance signals C (colour) are recorded separately on the tape. This provides better picture quality than with standard video (VHS and 8 mm) where the Y/C signals are

combined to provide only one video signal.

NICAM sound: Process by which digital sound can be transmitted.

System: Television pictures are not broadcast in the same way in all countries. There are different standards: BG, DK, I, and L L'. The **System** setting (p. 6) is used to select these different standards. This is not to be confused with PAL or SECAM colour coding. Pal is used in most countries in Europe, Secam in France, Russia and most African countries. The United States and Japan use a different system called NTSC. The inputs EXT1 and EXT2 are used to read NTSC coded recordings.

16:9: Refers to the ration between the length and height of the screen. Wide screen televisions have a ration of 16/9, conventional screen TV sets have a ration of 4/3.



© 2006 Koninklijke Philips N.V.

All rights reserved

Document order number: