

Philips
Professional LED TV

24" Studio
LED
DVB-T2/T/C

24HFL2829T



Great value in a modern design

with power-saving LED technology

This energy-efficient Hospitality TV can be installed efficiently using USB cloning and comes with dedicated hospitality features such as menu and control locking.

Advanced hotel features and future proof

- Ideally suited for prisons
- USB cloning of all settings for quick installation
- One combined channel list for Analogue and Digital channels
- Advanced volume control to avoid guest disturbance
- Greet your guests with a customisable welcome page
- Prevent unauthorised use by joystick control locking
- Installation menu locking
- Off-line channel editor to edit a channel list on a PC

Great viewing experience and guest comfort

- USB for multimedia playback
- Low power consumption
- LED TV for images with incredible contrast

PHILIPS

Highlights

LED TV

With LED backlighting, you can enjoy low power consumption and beautiful images with high brightness, incredible contrast and vibrant colours

Welcome page



A welcome page is displayed each time the TV set is switched on. The welcome page can be branded and customised easily at the time of installation via a simple welcome image in .png format.

USB Cloning

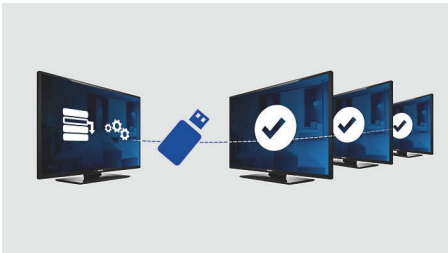

Provides the ability to easily copy all programming and channel programming

settings from one TV into other TV sets in less than a minute. The feature ensures uniformity between TV sets and significantly reduces installation time and costs.

PrisonMode

To control communication, this Hospitality TV is equipped with a specific PrisonMode setting. This Advanced Security Mode switches off certain settings not needed by the detention market, like Teletext, Electronic Programme Guide, Subtitles and USB ports.

USB (photos, music, video)



Share the fun. Connect your USB memory-stick, digital camera, mp3 player or other multimedia device to the USB port on your TV to enjoy photos, videos and music with the easy to use onscreen content browser.

Off-line channel editor

Off-line channel editor to edit a channel list on a PC

One combined channel list

One integrated channel list for digital and analogue channels. This allows the guest to flick seamlessly between Analogue and Digital channels.

Advanced volume control

With advanced volume control, you can select the start-up volume of the TV and predefine the volume range of the TV set, preventing excessive volume adjustments and avoiding the disturbance of neighbouring guests.

Joystick control locking

By disabling or enabling joystick control locking, the administrator can prevent unauthorised use of the TV via the joystick, saving the hotelier overheads.

Installation menu locking

Prevents unauthorised access to installation and configuration settings, to ensure maximum convenience for guests and to avoid unnecessary reinstallation costs.

Low power consumption

Philips TVs are designed to minimise power consumption. This will not only reduce environmental impact but also lower operating costs.

Specifications

Picture/Display

- Aspect ratio: 16:9
- Diagonal screen size (inch): 24 inch
- Diagonal screen size (metric): 60 cm
- Display: LED HD TV
- Panel resolution: 1366 x 768p
- Brightness: 220 cd/m²
- Picture enhancement: Digital Crystal Clear, 100 Hz Perfect Motion Rate
- Viewing angle: 176° (H)/176° (V)

Tuner/Reception/Transmission

- Digital TV: DVB-T/T2/C
- Analogue TV: PAL, SECAM

Features

- Ease of use: Picture Style, Sound Style
- Digital services: 8d EPG, MHEG, Teletext

Hospitality Features

- Hotel mode: Joystick Control Lock, Menu lock, Installation Menu Lock, Volume limitation
- Prison mode: high-security mode, TXT/MHEG/USB/EPG/Subtitle Lock
- Timer: Sleep Timer, Wake Up Alarm, Wake Up On Channel
- Anti-Theft: Battery Anti-theft Protection, Kensington Lock
- Your brand: Welcome Logo
- Cloning and Firmware update: via USB, Instant Initial Cloning
- Control: Block Automatic Channel Update
- Channels: Combined List, Off-Line Channel Editor

Healthcare features

- Control: Multi-Remote Control
- Convenience: Headphone out

Multimedia

- Video playback supported: Containers: AVI, MKV, Formats: H.264/MPEG4 AVC, MPEG1, MPEG2, MPEG4
- Music formats supported: MP3, AAC
- Subtitle formats supported: SRT, SSA SUB
- Picture formats supported: BMP, JPG, PNG
- Supp. Video Resolution on USB: up to 1920x1080p@30Hz
- Multimedia connections: USB

Audio

- Sound output Power: 5 (2x2.5) W
- Speakers: 2.0, Down Firing
- Sound Features: Equalizer, Balance, AVL, Incredible surround, Dynamic Bass

Power

- Mains power: AC 220-240 V; 50-60 Hz
- Ambient temperature: 5°C to 45°C
- Standby power consumption: <0.3 W
- Energy Label Class: A+
- EU Energy Label power: 19 W
- Power Saving Features: Eco mode
- Annual energy consumption: 27 kW·h

Accessories

- Included: Remote Control 22AV1407A/12, 2 x AAA batteries, Tabletop Stand, Warranty Leaflet, Legal and Safety brochure
- Optional: Setup RC 22AV9573A

Side Connectivity

- Common Interface Slot: CI+ 1.3
- Headphone out: Mini-Jack
- USB1: USB 2.0
- AV input: CVBS +L/R (Mini-Jack)

Rear Connectivity

- Scart: CVBS, RGB, SVHS
- Antenna: IEC-75
- HDMI1: HDMI 1.4
- Digital Audio out: Coaxial (SPDIF)
- VGA input: 15 pin D-sub

Connectivity Enhancements

- EasyLink (HDMI CEC): One touch play, System Standby
- HDMI: ARC (all ports)

Design

- Colour: Black

Dimensions

- Set Width: 554 mm
- Set Height: 336 mm
- Set Depth: 35/61 mm
- Product weight: 3.3 kg
- Set width (with stand): 554 mm
- Set height (with stand): 371 mm

- Set depth (with stand): 134 mm
- Product weight (+stand): 3,5 kg
- Wall-mount compatible: 75 x 75 mm, M4

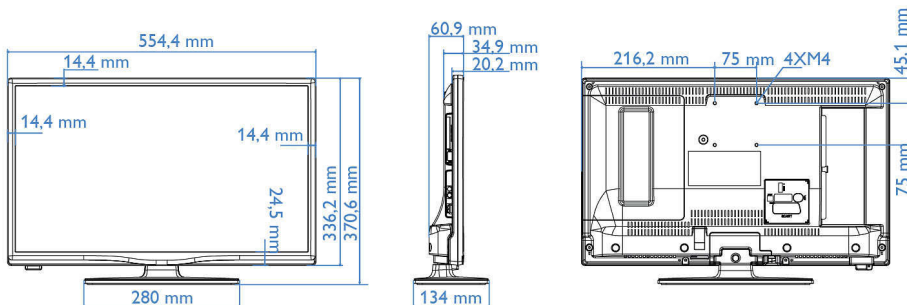

Issue date 2024-03-31

Version: 3.0.1

EAN: 87 18863 00390 9

© 2024 Koninklijke Philips N.V.
All Rights reserved.

Specifications are subject to change without notice.
Trademarks are the property of Koninklijke Philips N.V.
or their respective owners.

www.philips.com

* Availability of features will depend on implementation chosen by integrator.
* Typical on-mode power consumption measured according to IEC62087 Ed 2. The actual energy consumption will depend on how the TV is used.
* This television contains lead only in certain parts or components where no technology alternatives exist in accordance with existing exemption clauses under the RoHS Directive.