

Register your product and get support at
www.philips.com/welcome

4200 series

PHILIPS



English - Read the safety instructions.

Deutsch - Lesen Sie die Sicherheitshinweise.

Français - Lisez les consignes de sécurité.

Bahasa Indonesia - Baca petunjuk
keselamatan.

Bahasa Malaysia - Baca arahan
keselamatan.

ภาษาไทย โปรดอ่านคำแนะนำด้านความปลอดภัย

Tiếng Việt - Hãy đọc chỉ dẫn an toàn.

简体中文 - 请阅读安全说明。

العربية قراءة تعليمات السلامة.

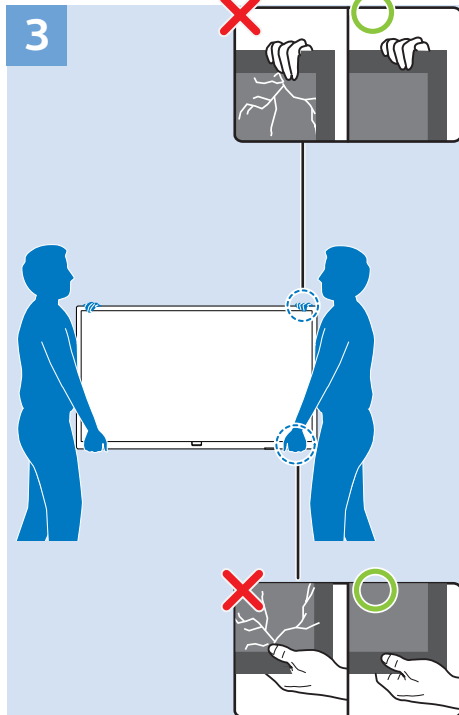
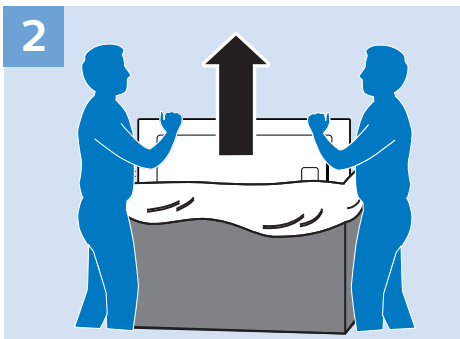
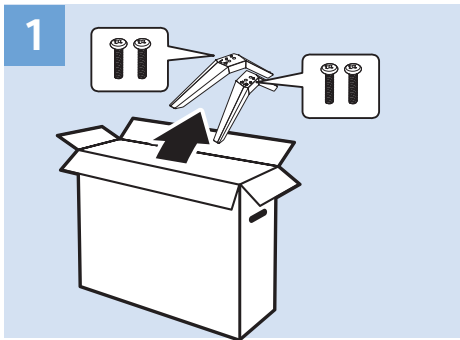
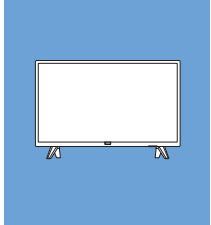

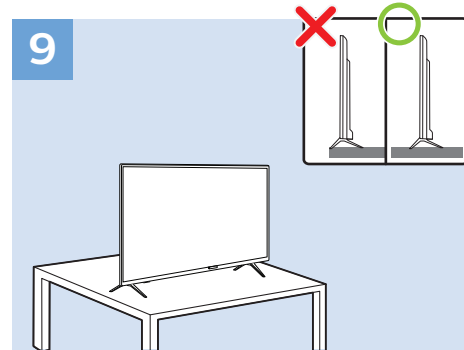
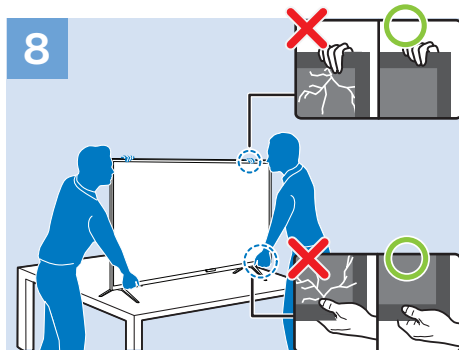
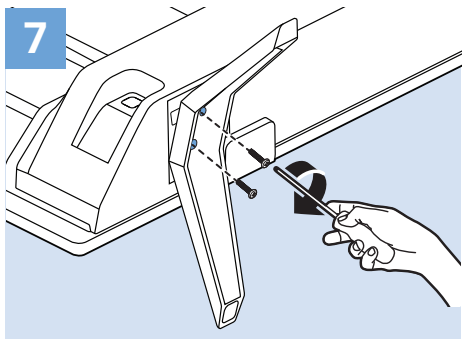
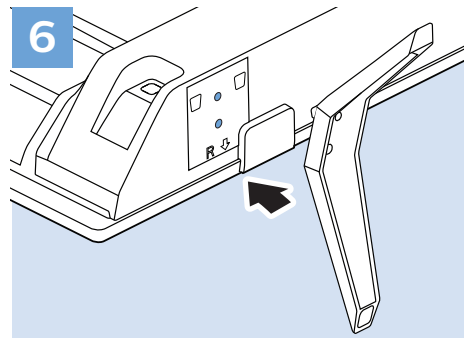
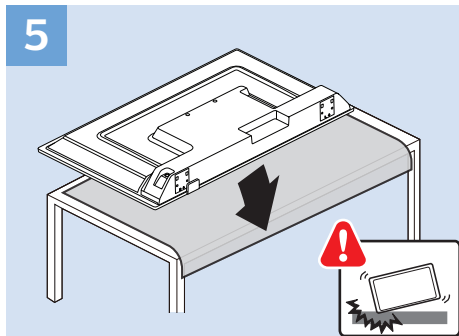
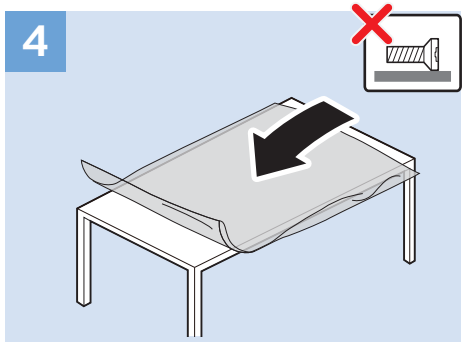

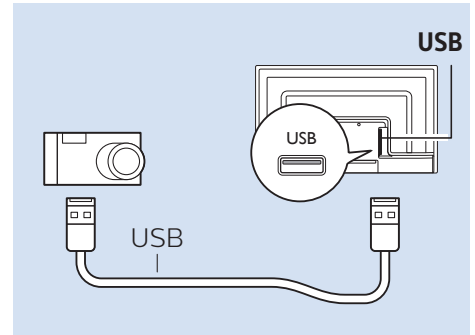
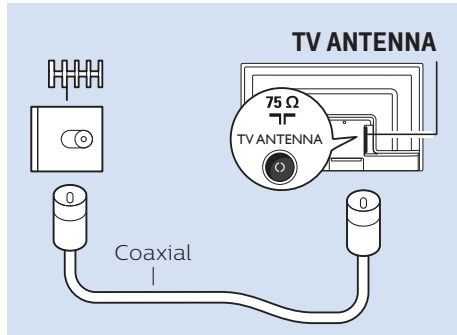
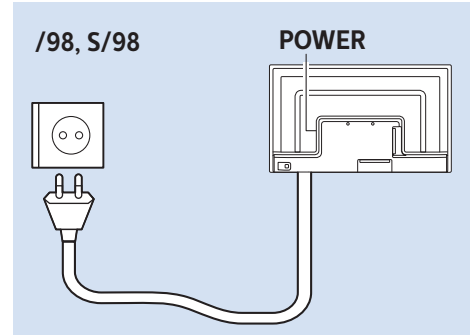
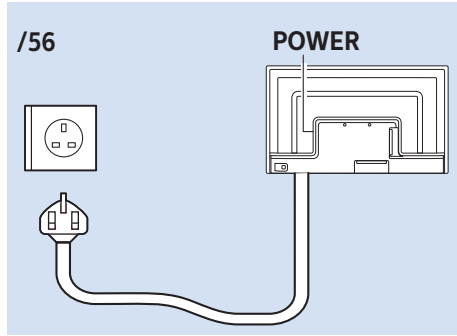
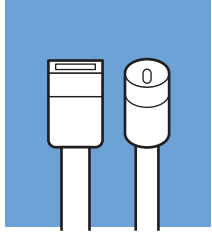

Digital Audio System - HDMI ARC

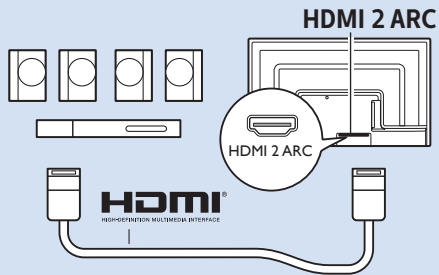

Digital Audio System - OPTICAL

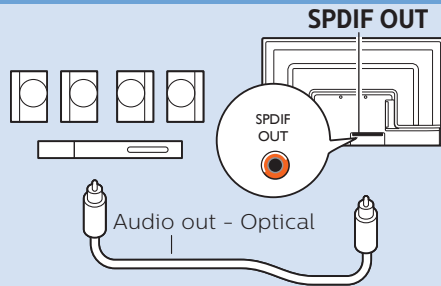

DVD Player

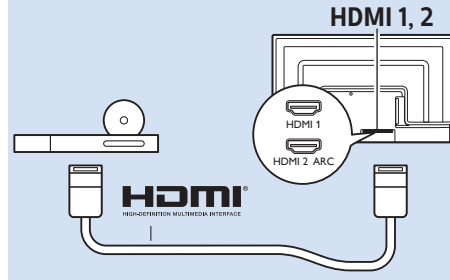

Video player

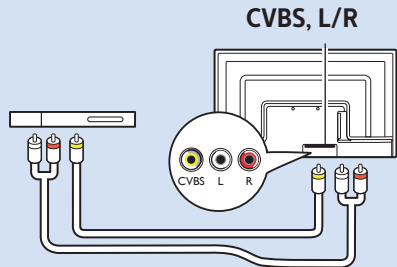

Headphone

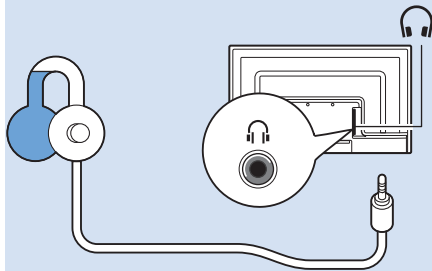

USB Hard Drive

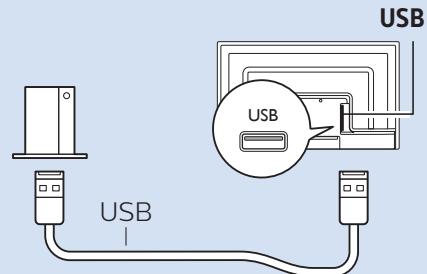

USB Flash Drive

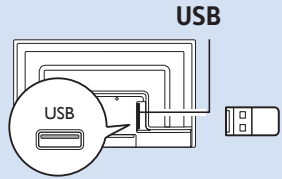

MHL

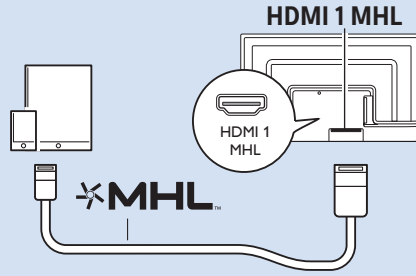

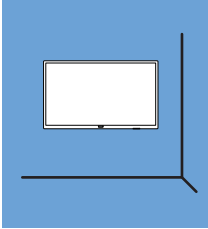

VESA (x, y)

32" 100 M6

80cm

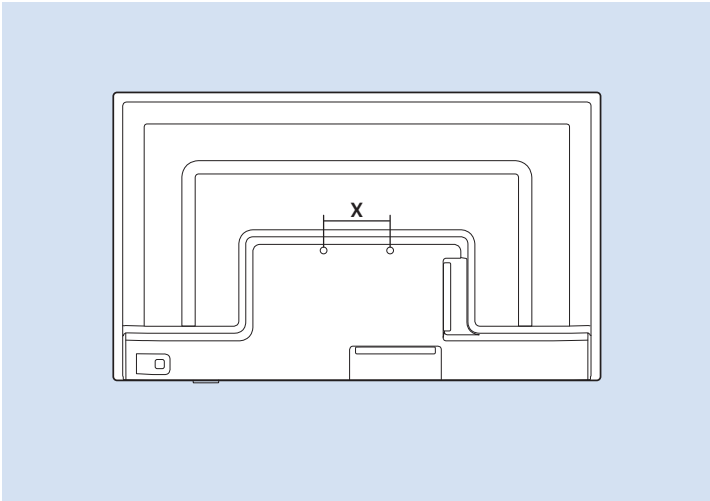

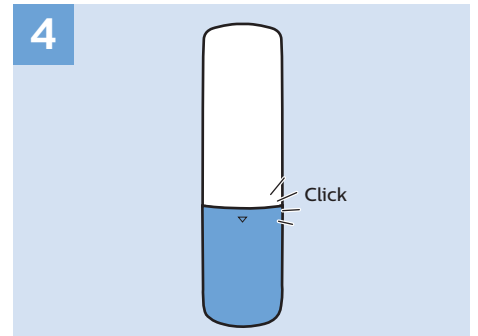
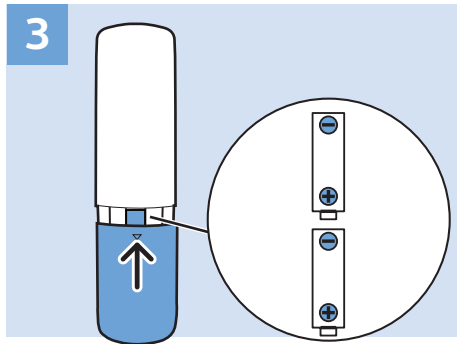
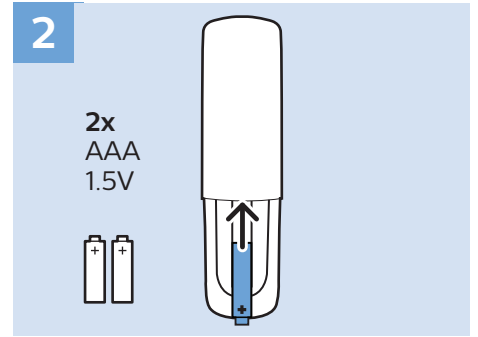
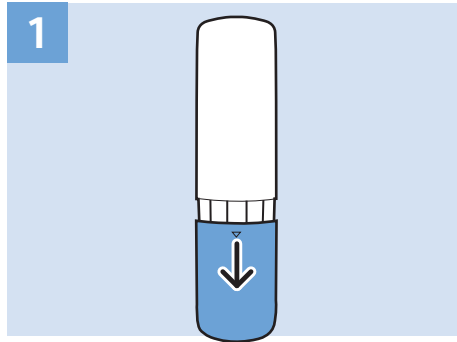
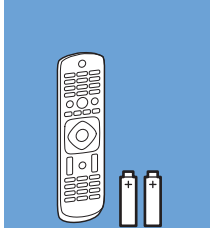

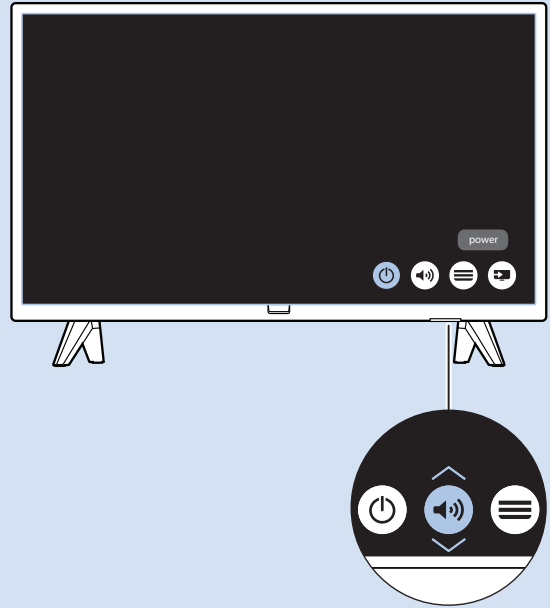
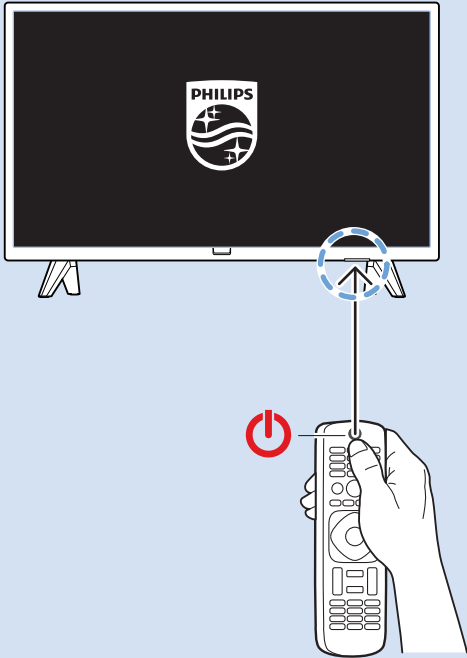



Help

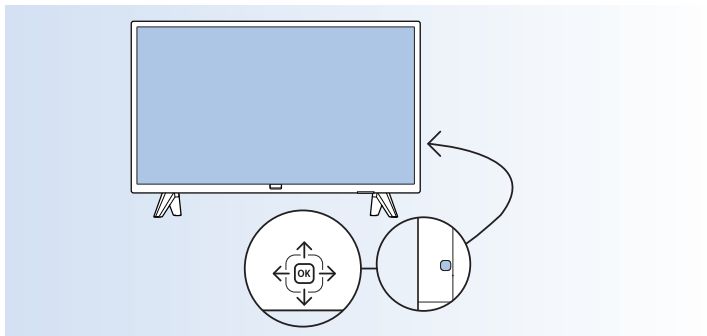

www.philips.com/TVsupport



4200 Series
User Manual





All registered and unregistered trademarks are property of their respective owners.
Specifications are subject to change without notice.
Philips and the Philips' shield emblem are trademarks of Koninklijke Philips N.V.
and are used under license from Koninklijke Philips N.V.
2018 © TP Vision Europe B.V. All rights reserved.

[philips.com](https://www.philips.com)