

Register your products and get support at
www.philips.com/welcome

6000 Series

Quick start guide

PHILIPS



English

Before using your product, read all accompanying safety information.
(The relevant parameters of instructions are variable, without prior notice, if there is any discrepancy, please in accordance with actual object.)

Brazilian Portuguese

Antes de utilizar o produto, leia todas as informações de segurança que o
(Os parâmetros de instruções estão sujeitos a alterações sem aviso prévio. Se acompanham, houver alguma discrepância, o objeto real prevalecerá.)

Português

Antes de utilizar o nosso produto, leia toda a informação de segurança incluída.
(Os parâmetros das instruções estão sujeitos a alterações sem aviso prévio. Caso haja alguma discrepância, deverá prevalecer o objeto real.)

Deutsch

Lesen Sie vor dem Gebrauch des Geräts alle dem Produkt beiliegenden Sicherheitsinformationen durch.
(Der Inhalt dieser Anleitungen unterliegt unangekündigten Änderungen. Im Fall von Abweichungen ist das tatsächliche Produkt maßgebend.)

Français

Avant d'utiliser votre produit, veuillez lire les informations de sécurité jointes.
(Les paramètres d'instructions sont sujets à des changements sans notification préalable. En cas d'anomalie, l'objet réel prévaudra.)

العربية

قبل استخدام المنتج، اقرأ كل معلومات السلامة المرفقة
(المعلومات المناسبة للتعليمات عرضة للتغيير دون إشعار مسبق. في حالة وجود تعارض، فلارجاء الرجوع إلى المنتج الفعلي.)



English
Brazilian Portuguese
Português
Deutsch
Français

What's in the box
Conteúdo da caixa
O que está na caixa
Verpackungsinhalt
Ce que la boîte contient
العربية
ماذا في الصندوق

(43"/50"/55")

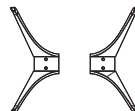
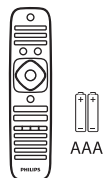
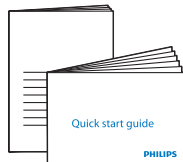
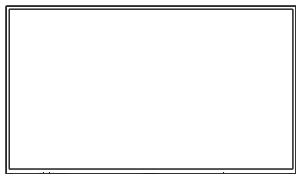

(4 pcs)

(75")

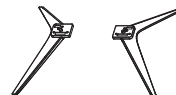
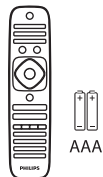
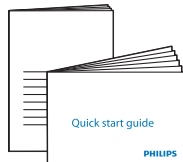
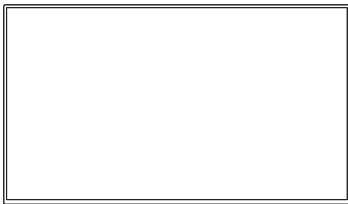

(6 pcs)

1

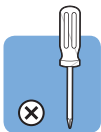

English
Brazilian Portuguese
Português
Deutsch
Français

Mount the stand
Monte o suporte
Instalar o suporte
Standfuß befestigen
Montez le support

تركيب الحامل العربية

(43"/50"/55")

1

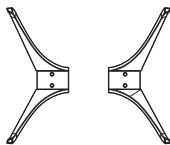

2

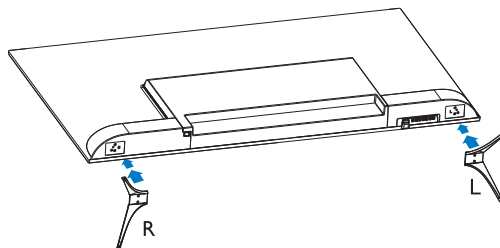

3

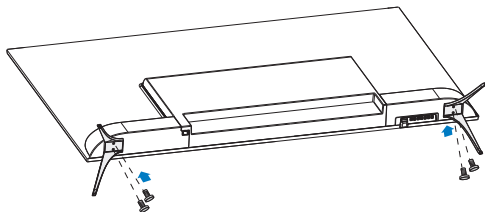

(75")

1

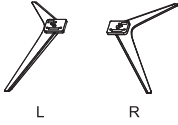

2

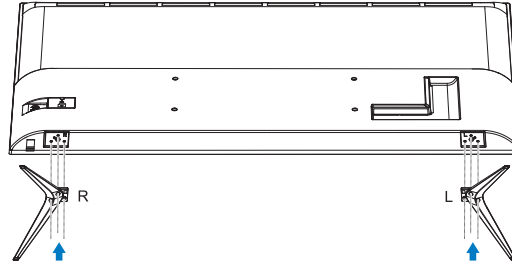

3

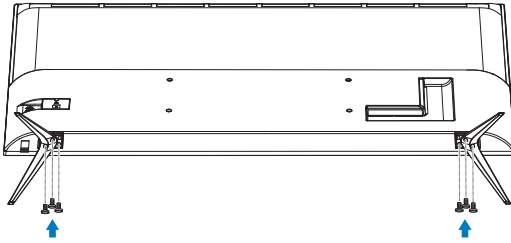

2

English
Brazilian Portuguese
Português
Deutsch
Français

Connect
Conecte
Ligar
Verbinden
Connectez
العربية تركيب الحامل

(43"/50"/55")

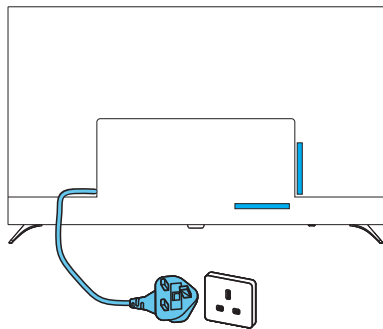

Coaxial-OUT LAN HDMI 1 (4K) HDMI 2(4K) (ARC) VGA AV - IN VIDEO AUDIO-L AUDIO-R AUDIO-OUT

ANT/CABLE HDMI 3(4K) (MHL)5V=2A USB 2 USB 1 5V=500mA 5V=300mA

(75")

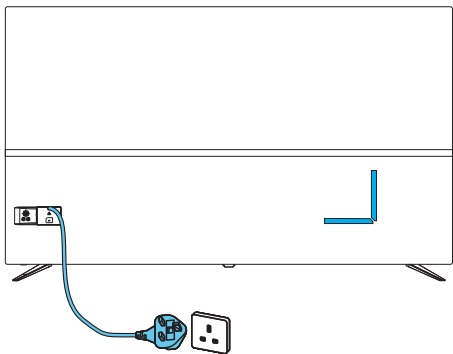

Coaxial-OUT LAN HDMI 1 (4K) HDMI 2(4K) (ARC) VGA AV - IN VIDEO AUDIO-L AUDIO-R AUDIO-OUT

ANT/CABLE HDMI 3(4K) (MHL) 5V=ZA USB 2 5V=300mA USB 1 5V=300mA

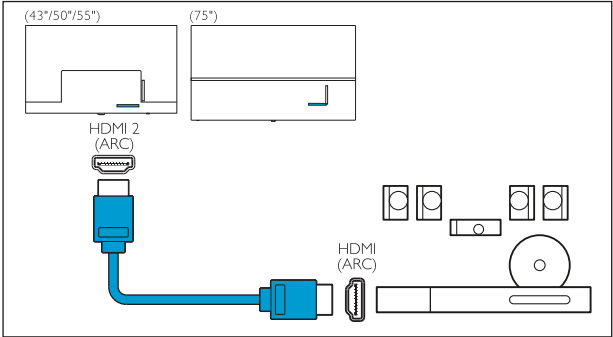
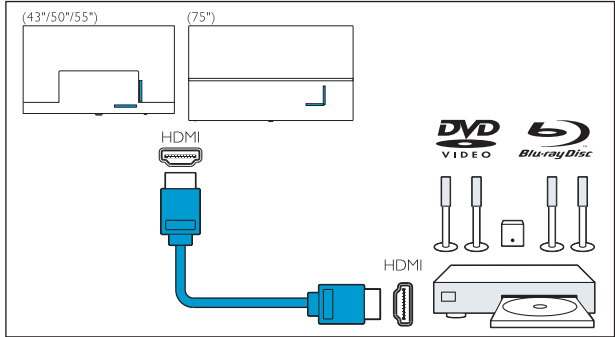
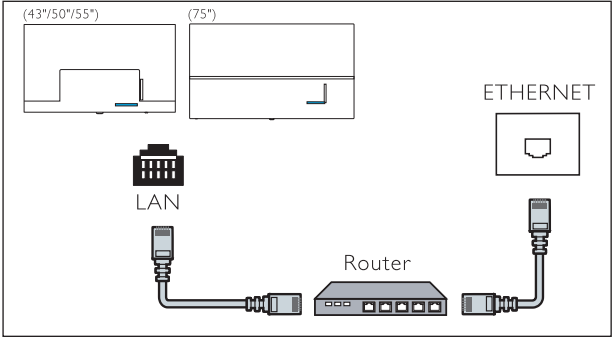
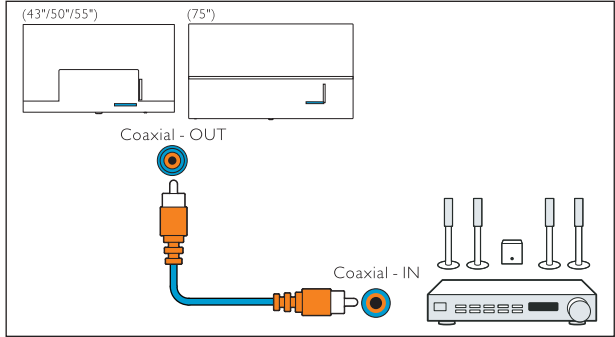

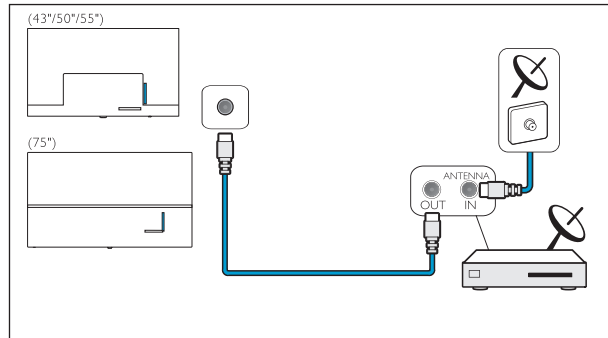
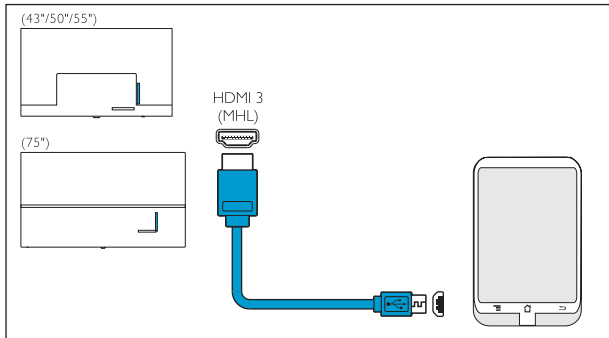
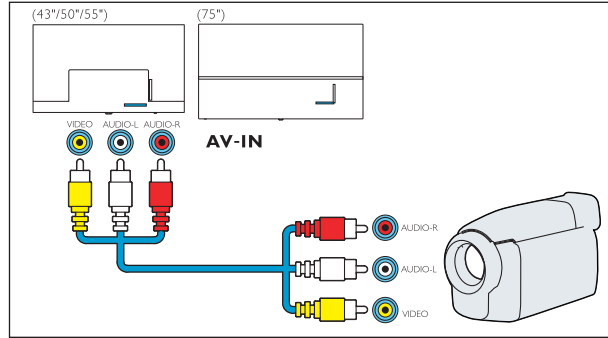
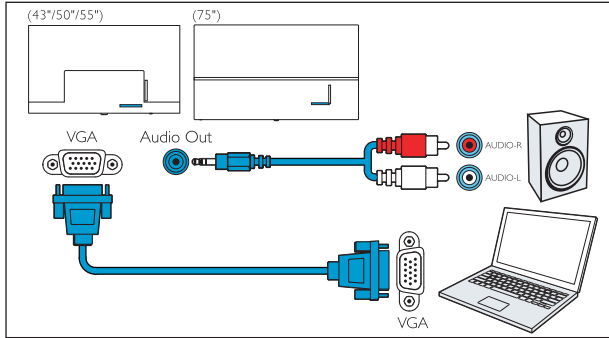

3

English
Brazilian Portuguese
Português
Deutsch
Français

Insert batteries
Insira as baterias
Inserir as pilhas
Batterien einlegen
Insérez les piles

العربية
تركيب البطاريات

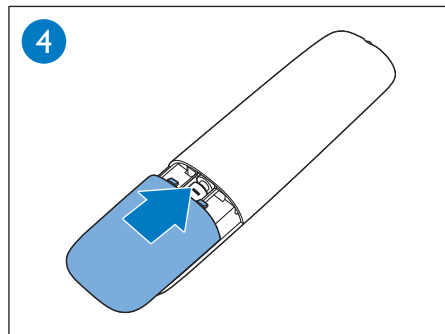
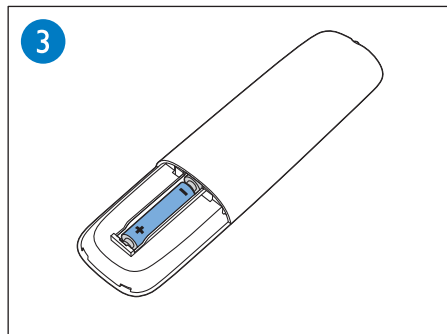
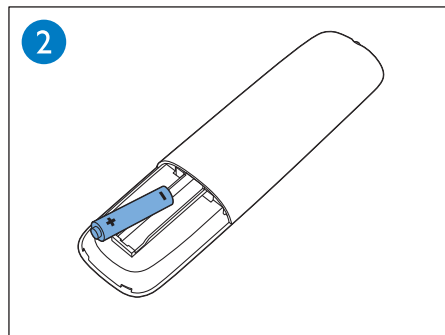
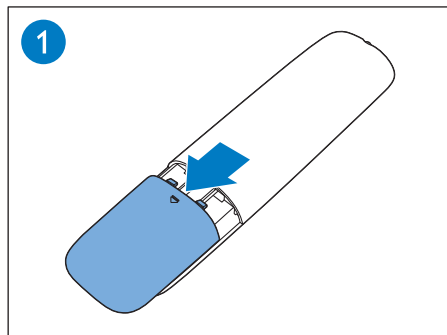



English
Brazilian Portuguese
Português
Deutsch
Français

To wall mount, purchase a suitable bracket.
Para montagem na parede, adquira um suporte de parede adequado.
Para montar na parede, adquira um suporte de montagem na parede adequado.
Für die Wandmontage kaufen Sie bitte eine geeignete Wandhalterung.
Pour une fixation murale, achetez un support mural approprié.

العربية للتثبيت على الحائط، اشترِ حاملًا مناسبًا.

TV	H	V
108 cm / 43"	400 mm	200 mm
126 cm / 50"	200 mm	200 mm
139 cm / 55"	200 mm	200 mm
189 cm / 75"	600 mm	200 mm

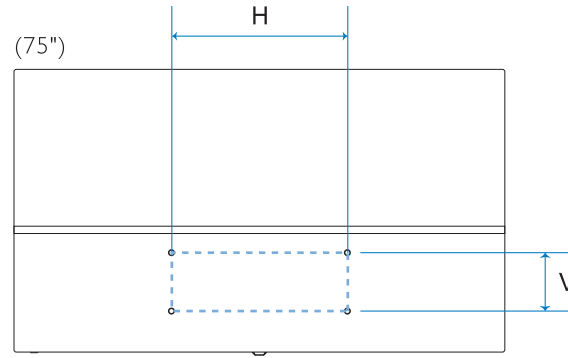
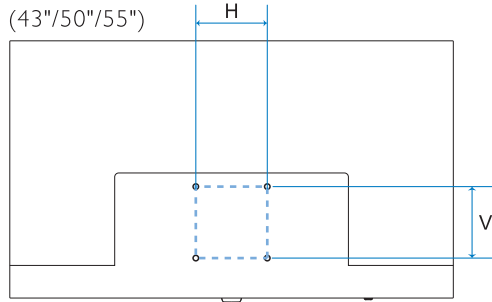

4

(43"/50"/55")

English

Brazilian Portuguese

Português

Deutsch

Français

Press the  key on the side panel of the TV or on the remote control to turn on the TV.

Pressione a tecla  no painel lateral da TV ou no controle remoto para ligar a TV.

Prima a tecla  no painel lateral da televisão ou no controle remoto para ligar a televisão.

Drücken Sie die Taste  an der Seite des Geräts oder auf der Fernbedienung, um das Fernsehgerät einzuschalten.

Appuyez sur la touche  sur le panneau latéral du téléviseur ou sur la télécommande pour allumer le téléviseur.

العربية اضغط على مفتاح  من الزوحة الجانبية للتلفاز أو من وحدة التحكم عن بعد لتشغيل التلفاز.

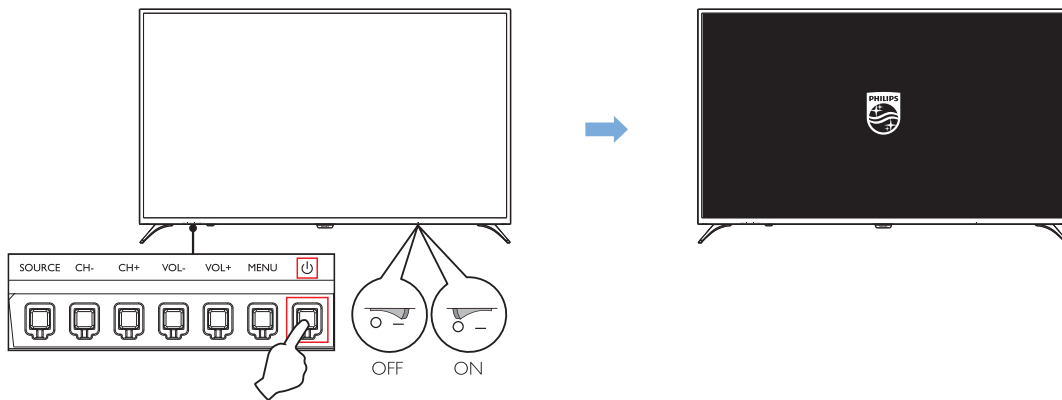

(75")

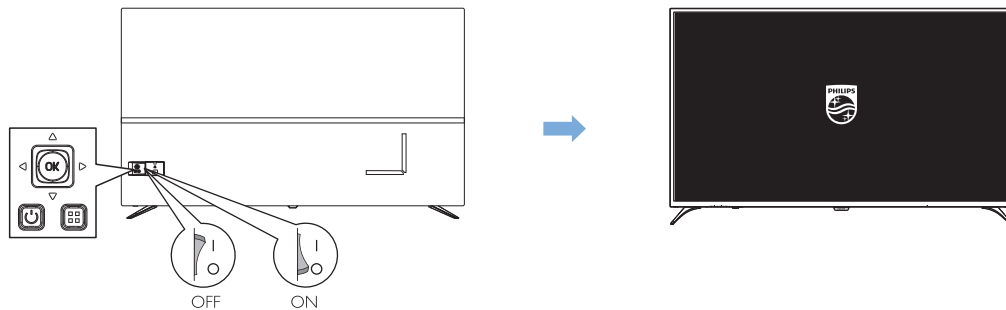

English

Press the  key on the back of the TV or on the remote control to turn on the TV

 MEMU: open or close menu.

OK Joystick key

- OK key
 - In OSD menu: confirm the operation.
 - In TV mode: show the source list.
- Press joystick key up/down/left/right
 - In OSD menu: operation the menu.
 - In TV mode:
 - Press joystick key up/down to switch the channel.
 - Press joystick key left/right to adjust the volume.

Brazilian Portuguese

Prima o botão  na parte posterior da televisão ou no telecomando para ligar a televisão.

 MEMU: abrir ou fechar menu.

OK Tecla Joystick

- Tecla OK
 - No menu OSD: confirmar a operação.
 - Em modo TV: exibir lista de fonte.
- Prima a Tecla joystick cima/baixo/esquerda/direita
 - No menu OSD: operação do menu.
 - Em modo TV:
 - Prima a Tecla joystick para cima/baixo para mudar de canal.
 - Prima a Tecla joystick para a esquerda/direita para ajustar o volume.

Português

Prima a tecla  na traseira da TV ou no controlo remoto para ligar a TV.

 MEMU: abrir ou fechar o menu.

OK Tecla joystick

- Tecla OK
 - No menu OSD: confirme a operação.
 - No modo TV: exibe a lista de entradas.
- Prima a tecla joystick para cima/baixo/esquerda/direita
 - No menu OSD: funcionamento do menu.
 - No modo TV:
 - Prima a tecla joystick para cima/baixo para mudar de canal.
 - Prima a tecla joystick para a esquerda/direita para ajustar o volume.

Deutsch

Zum Einschalten des Fernsehers drücken Sie die **⏻** Taste auf der Geräterückseite oder auf der Fernbedienung.

☰ MEMU: Menü öffnen oder schließen.

OK Joystick

- OK
 - Im OSD-Menü: Bestätigung.
 - Im TV-Modus: Liste der Signalquellen anzeigen.
- Joystick aufwärts/abwärts/nach links/nach rechts drücken
 - Im OSD-Menü: Navigation im Menü.
- Im TV-Modus:
 - Joystick aufwärts/abwärts drücken, um Kanal umzuschalten.
 - Joystick nach links/nach rechts drücken, um die Lautstärke einzustellen.

Français

Appuyez sur la touche **⏻** au dos du téléviseur ou sur la télécommande pour allumer le téléviseur.

☰ MEMU: ouvrir ou fermer le menu.

OK Touche joystick

- Touche OK
 - Dans le menu OSD : confirmer l'opération.
 - En mode TV : afficher la liste des sources.
- Appuyer sur la touche joystick haut/bas/gauche/droite
 - Dans le menu OSD : exploiter le menu.
- En mode TV:
 - Appuyer sur la touche joystick haut/bas pour changer de chaîne.
 - Appuyer sur la touche joystick gauche/droite pour régler le volume.

العربية

اضغط على مفتاح **⏻** من الجزء الخلفي من التلفاز أو من وحدة التحكم عن بعد لتشغيل التلفاز.

☰ MEMU : يفتح القائمة أو يغلقها.

OK مفتاح التحكم

- **OK** مفتاح
 - في القائمة المعروضة على الشاشة: تأكيد العملية.
 - في وضع التلفاز: يعرض قائمة المصادر.
 - اضغط على مفتاح التحكم لأعلى/لأسفل/للليسار/لليمين
 - في القائمة المعروضة على الشاشة: عرض القائمة.
 - في وضع التلفاز:
 - اضغط على مفتاح التحكم لأعلى/لأسفل لتغيير القناة.
 - اضغط على مفتاح التحكم لليسار/لليمين لضبط مستوى الصوت.



English
Brazilian Portuguese
Português
Deutsch
Français

Please refer to the User's Manual and the Philips support website for more operating instructions.
Consulte o Manual do Usuário ou o site de suporte da Philips para obter instruções de uso adicionais.
Consulte o Manual do utilizador ou o sítio Web de suporte da Philips para obter mais instruções de funcionamento.
Weitere Gebrauchsanleitungen finden Sie in der Bedienungsanleitung oder auf der Support-Webseite von Philips.
Veuillez consulter le Manuel d'Utilisateur ou le site de support Philips pour plus d'instructions d'utilisation.

الرجاء الرجوع إلى دليل المستخدم وموقع ويب دعم Philips للحصول على المزيد من تعليمات التشغيل العربية





All registered and unregistered trademarks are property of their respective owners. Specifications are subject to change without notice. Philips and the Philips' shield emblem are trademarks of Koninklijke Philips N.V. and are used under license from Koninklijke Philips N.V.

2018 ©TPVision Europe B.V. All rights reserved.
philips.com

