

7805 series Quick Start Guide

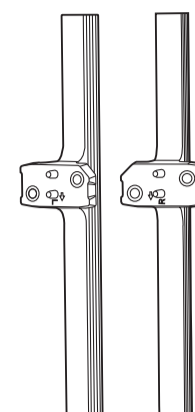

x4

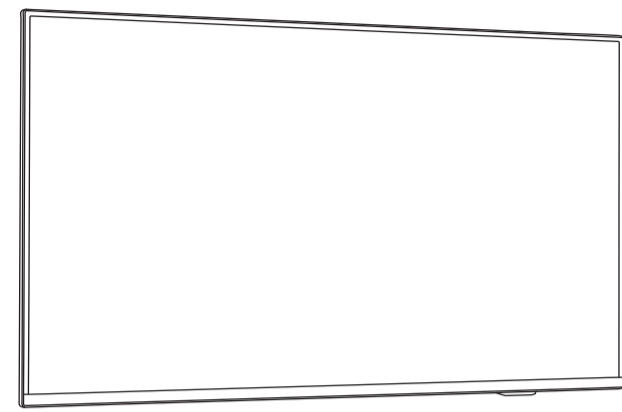
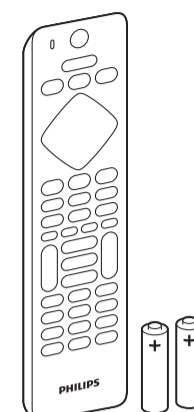

x2

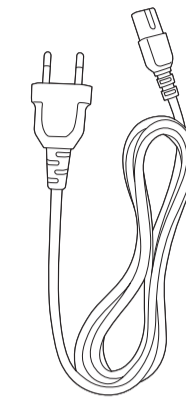
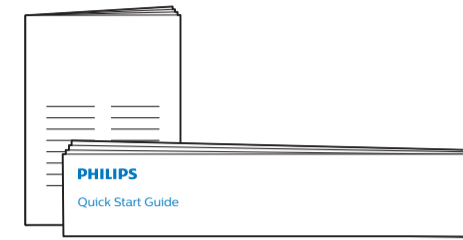

A

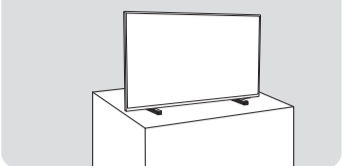

B

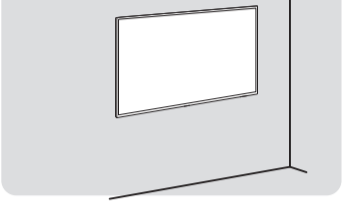

A

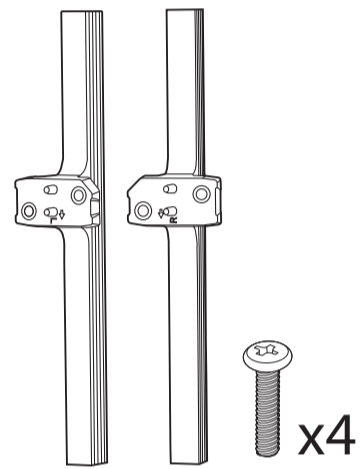
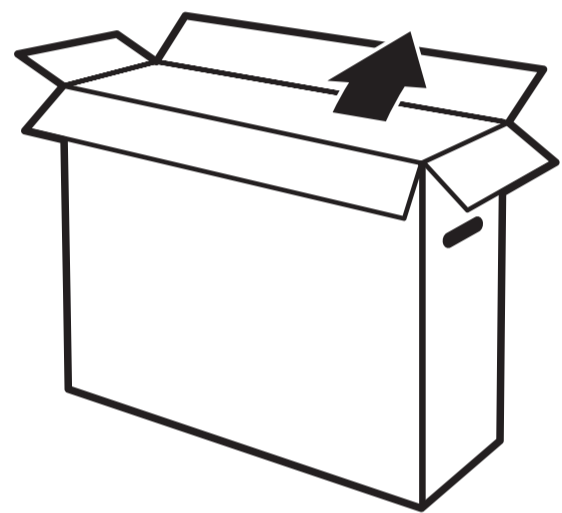

1

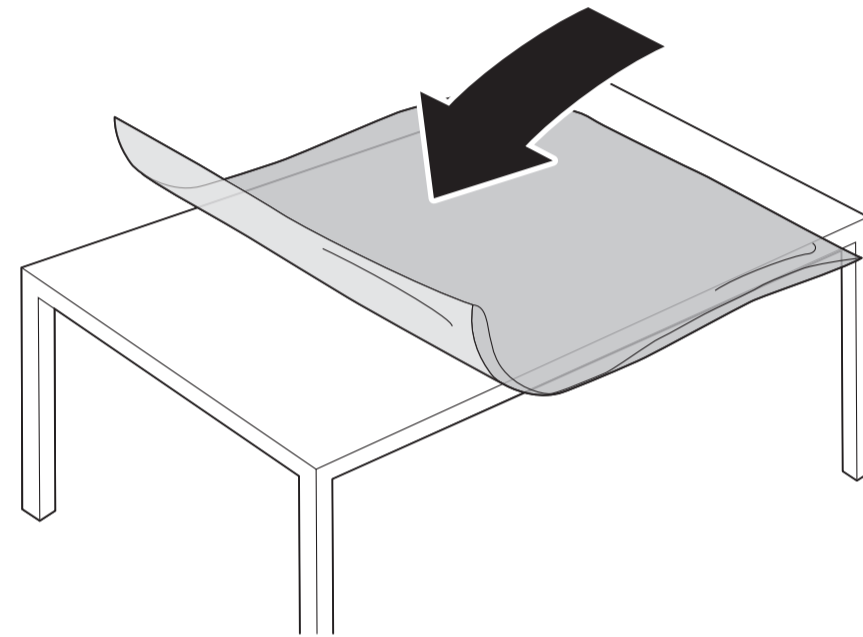

2

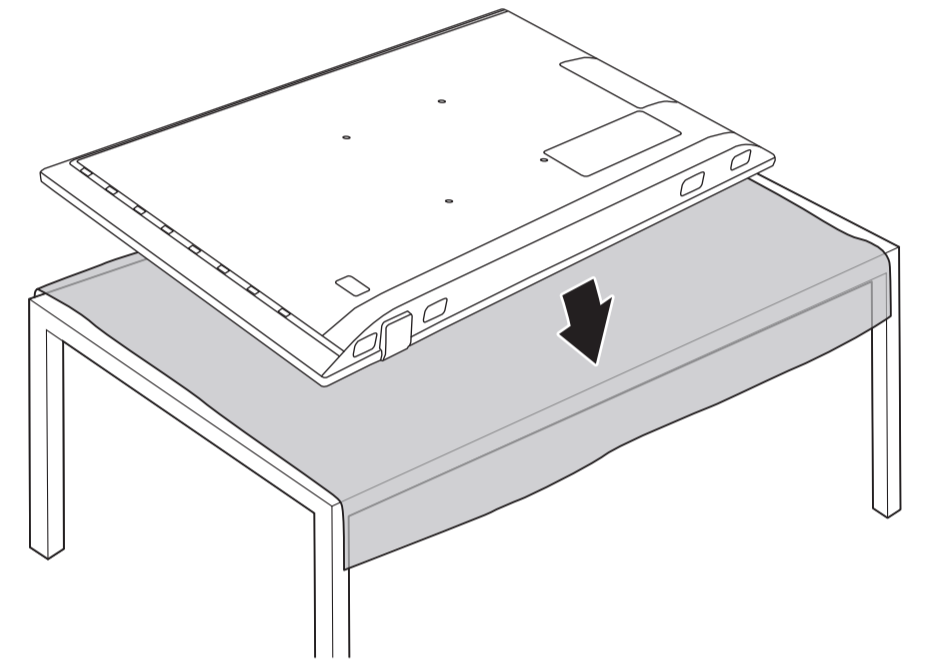

3

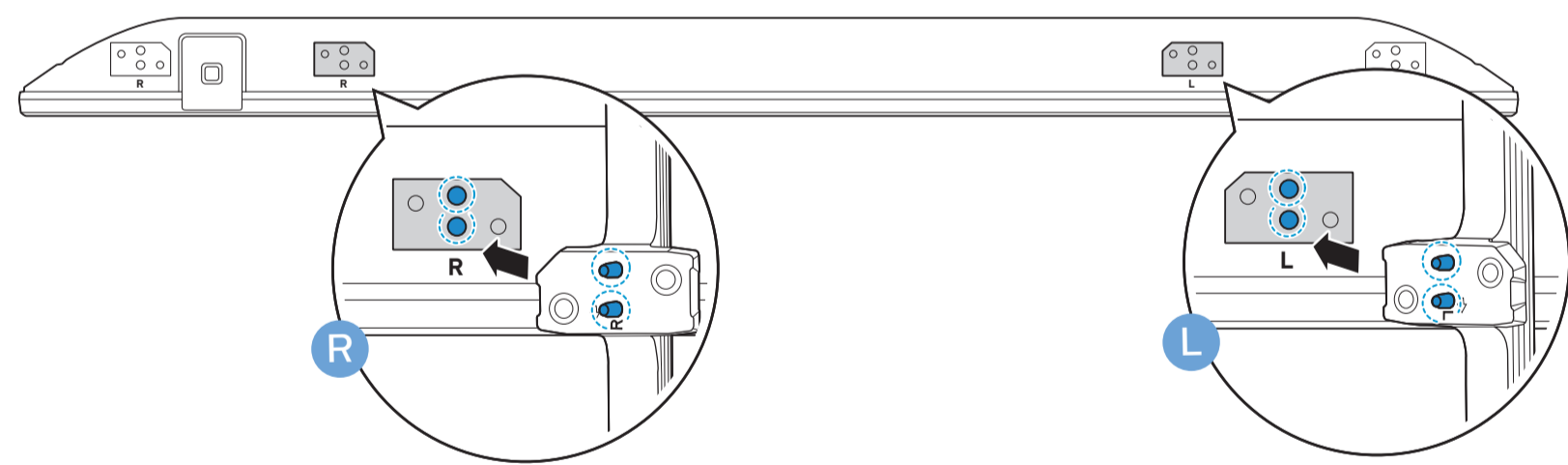

4



5

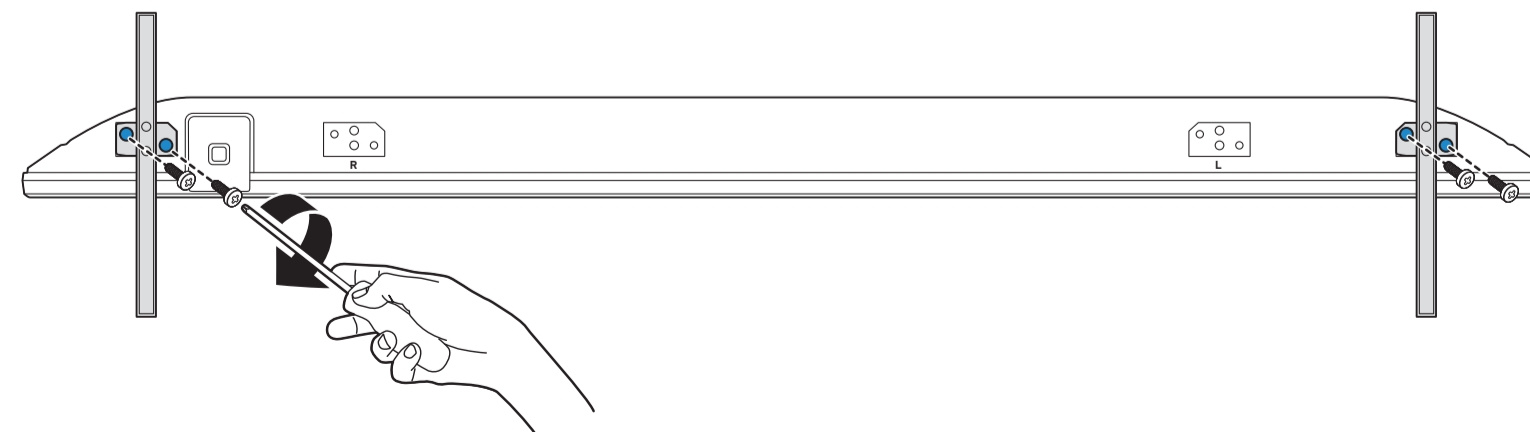
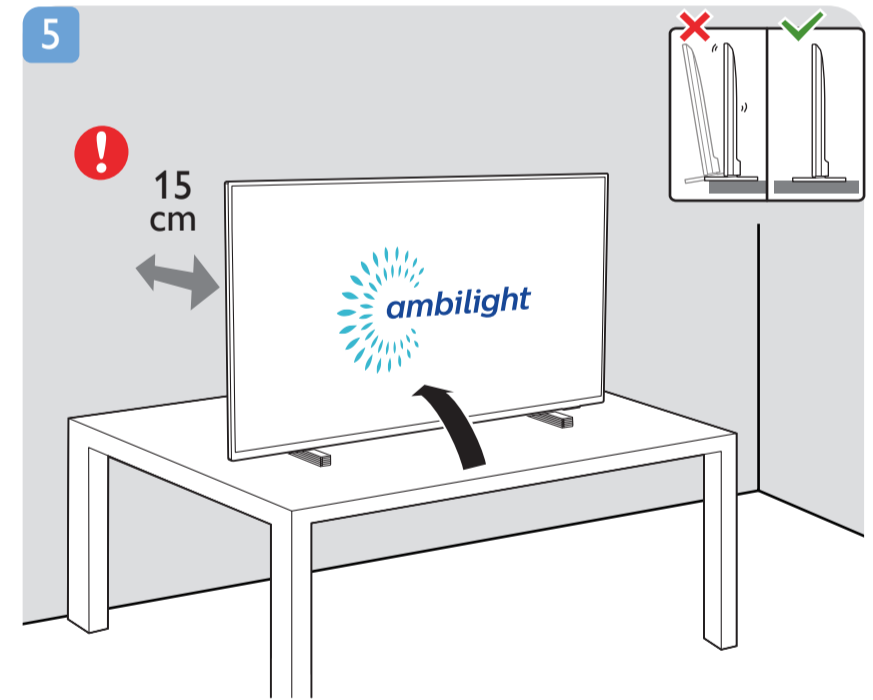

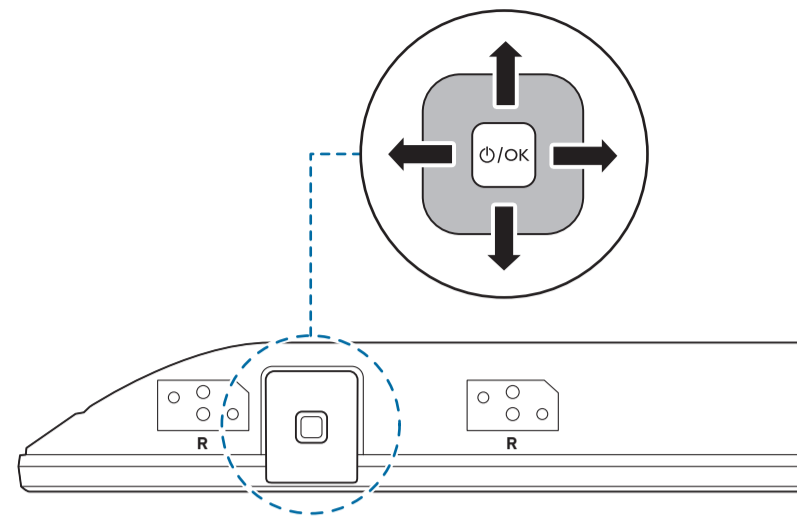
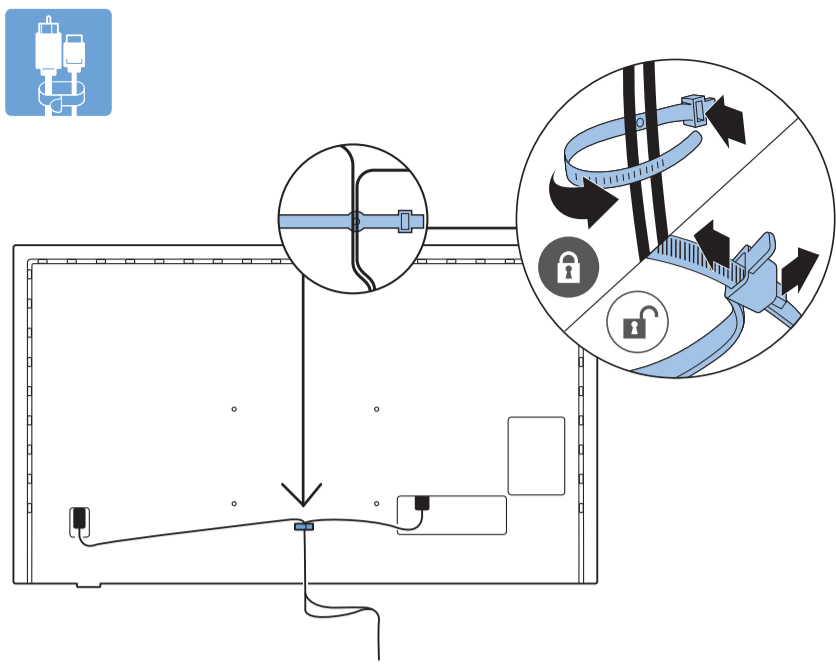

English Read the safety instructions.
Türkçe Güvenlik talimatlarını okuyun.



Register your product and get support at www.philips.com/TVsupport

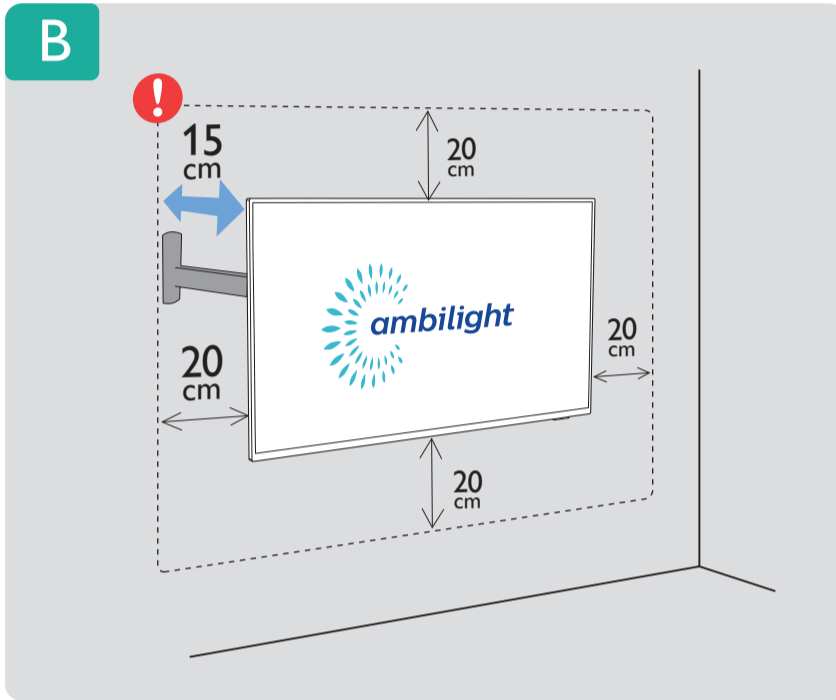
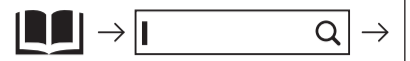

VESA (x, y)

55" 300 x 200mm M6 (L: 10 mm-16 mm)

139 cm



1

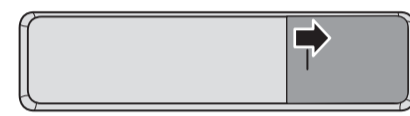

2

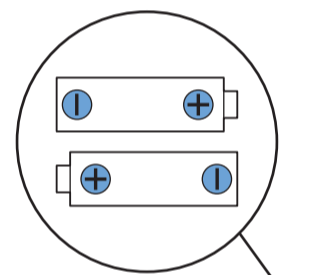

3



2x AAA LR03 1.5V

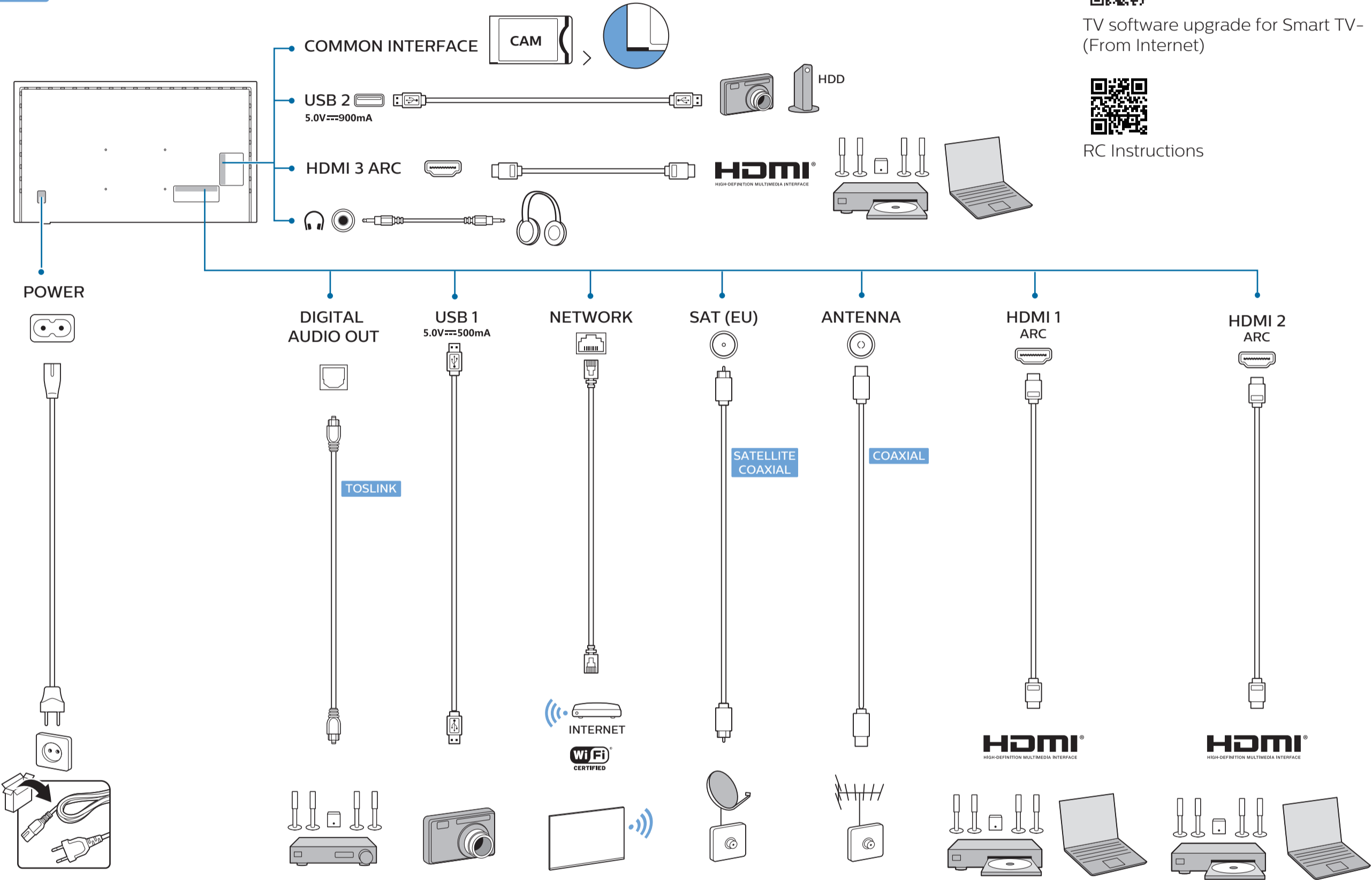
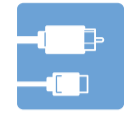
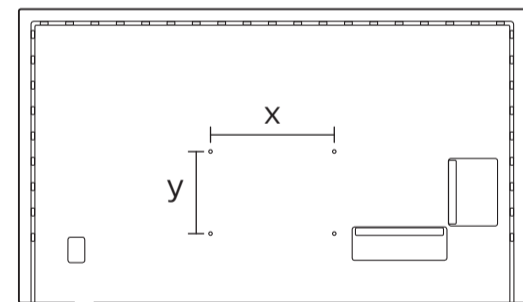
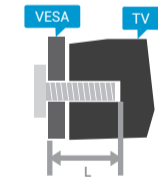

TV software upgrade for Smart TV- (From Internet)



RC Instructions

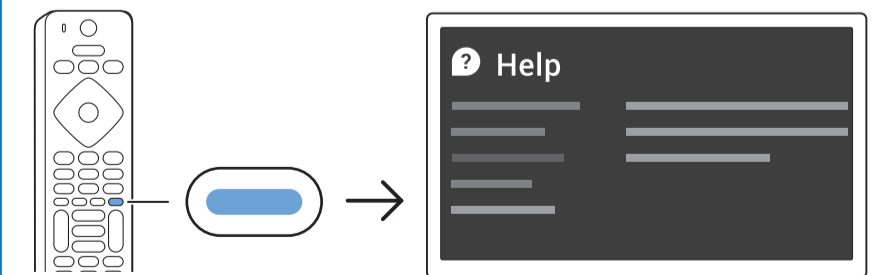
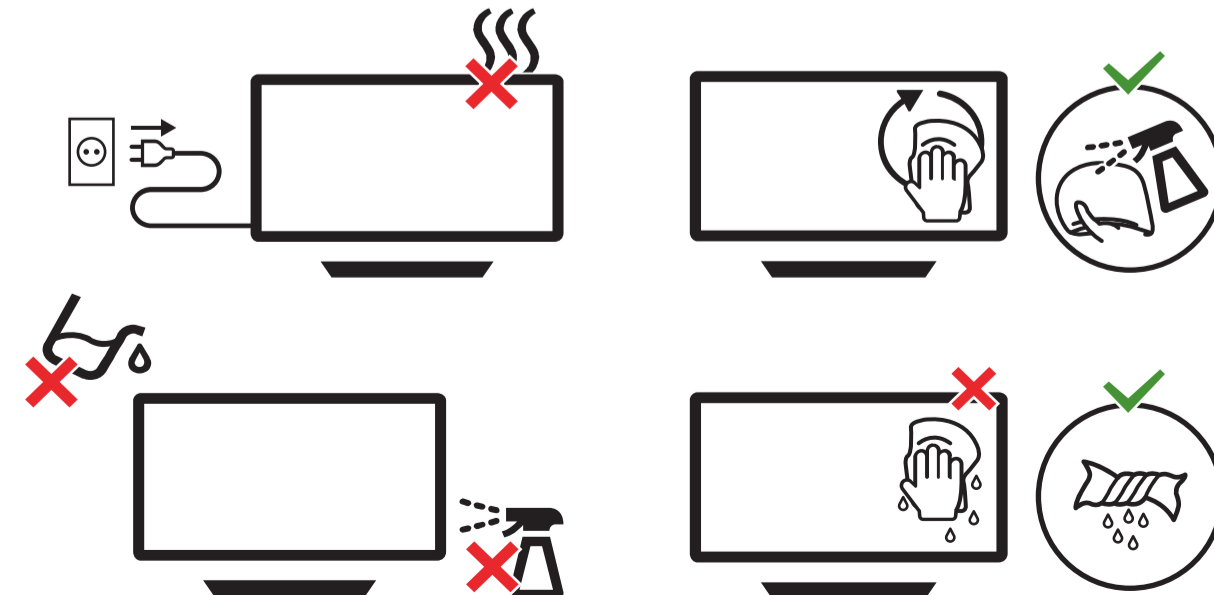
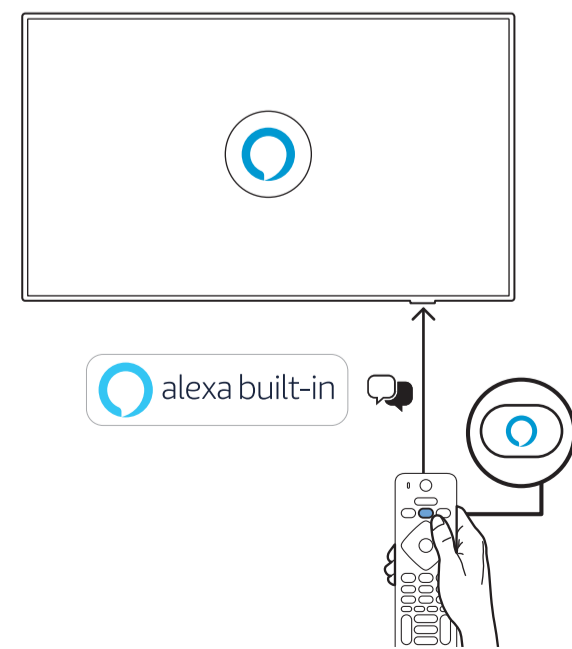
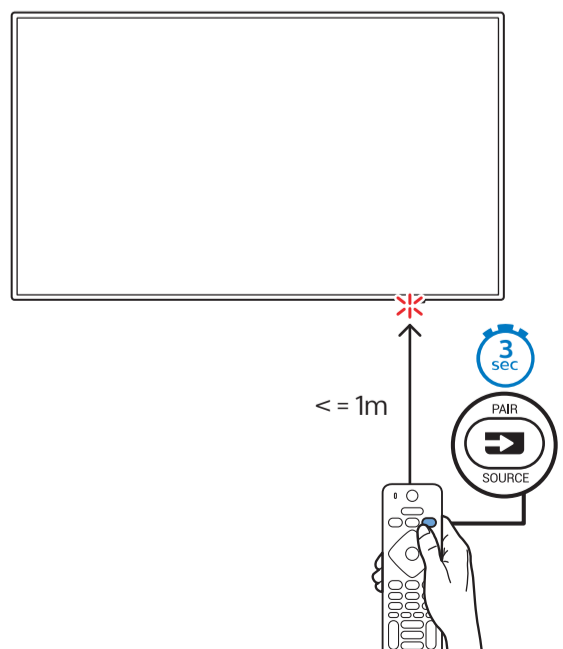

All registered and unregistered trademarks are property of their respective owners. Specifications are subject to change without notice. Philips and the Philips' shield emblem are trademarks of Koninklijke Philips N.V. and are used under license from Koninklijke Philips N.V. 2020 © TP Vision Europe B.V. All rights reserved. philips.com