

86PUH8504/96

快速使用指南

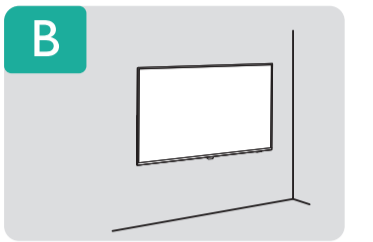
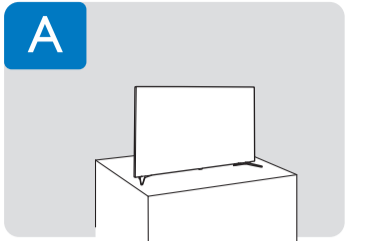
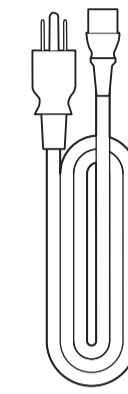
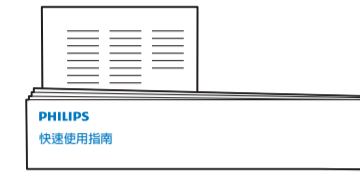
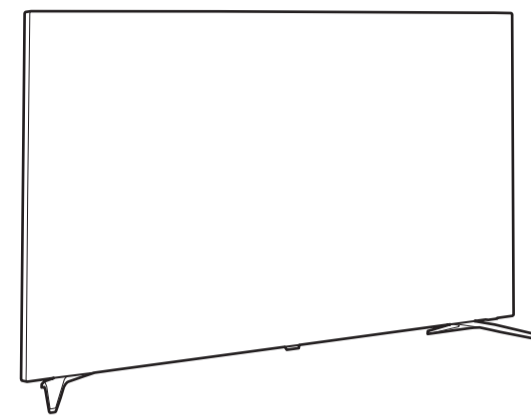

A

1

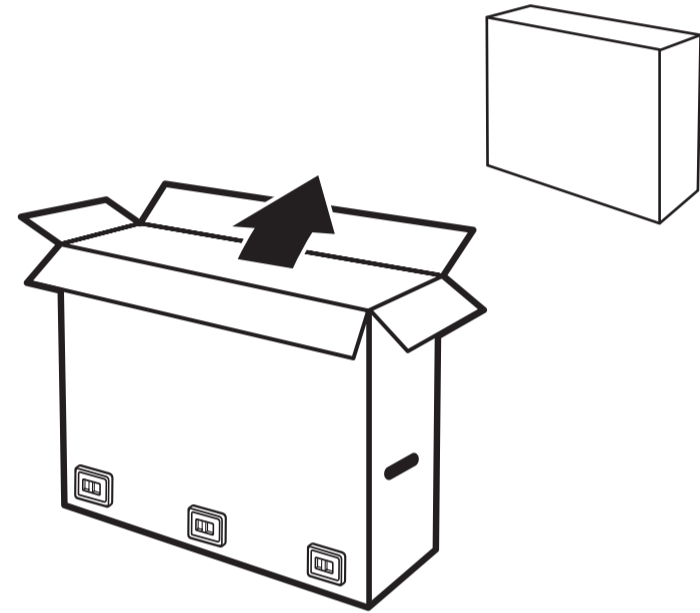

2

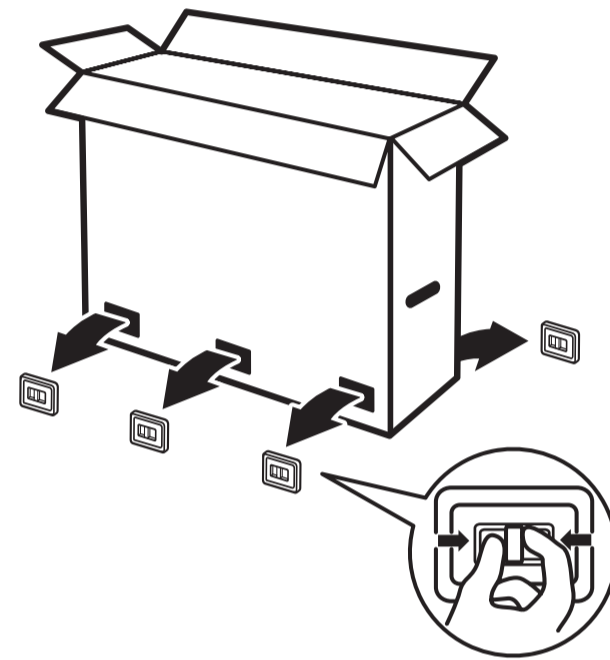

3

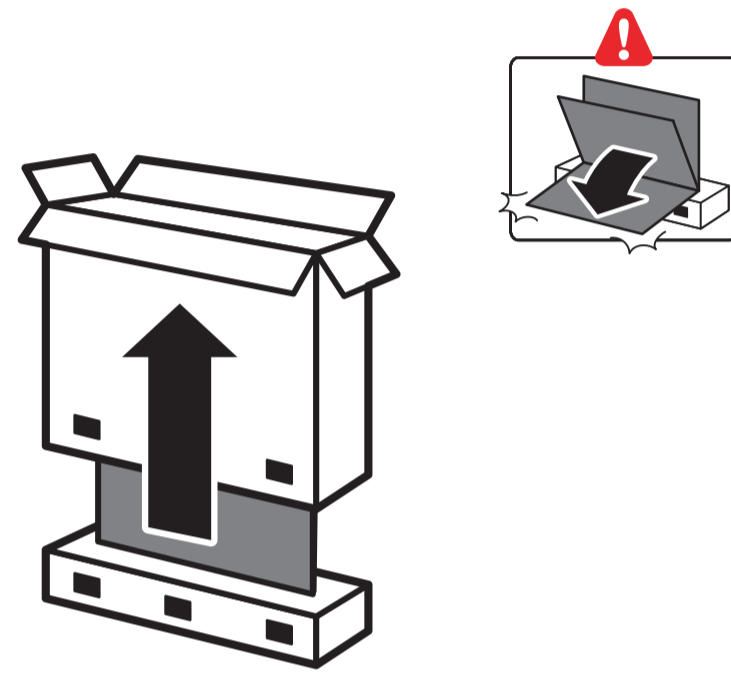

4

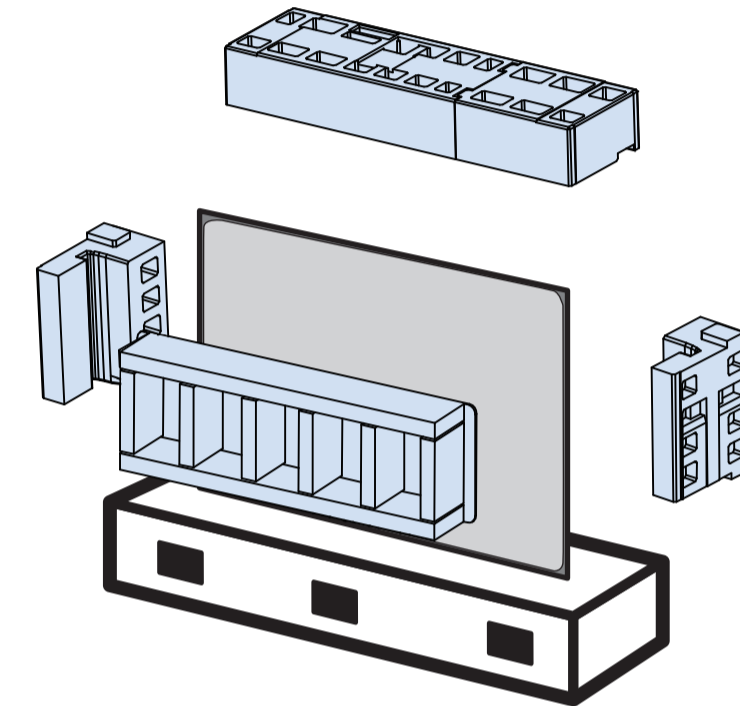

5

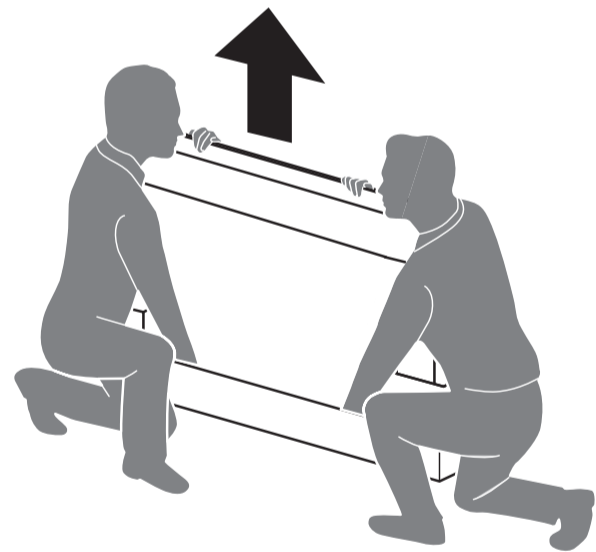

6

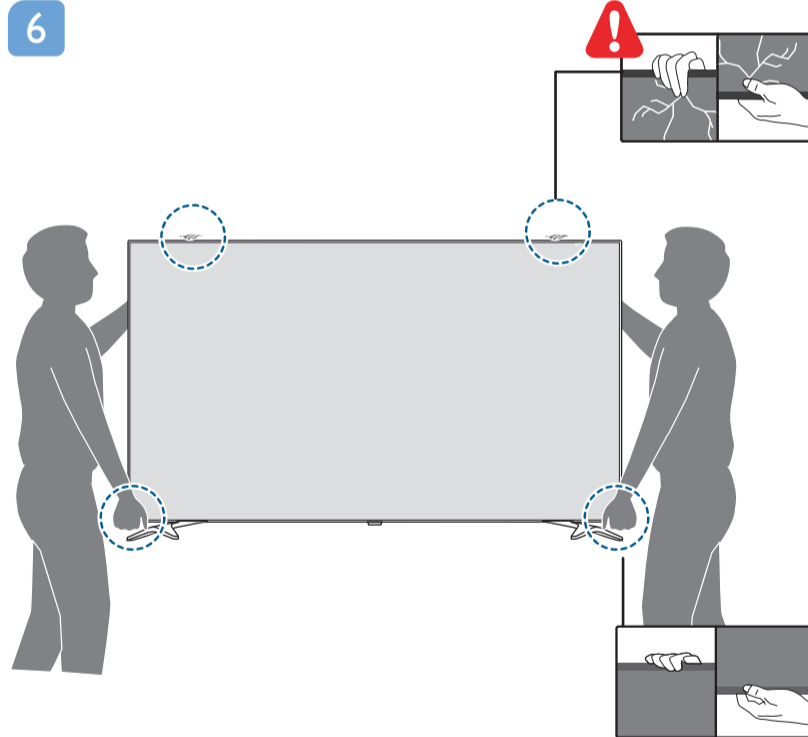

7

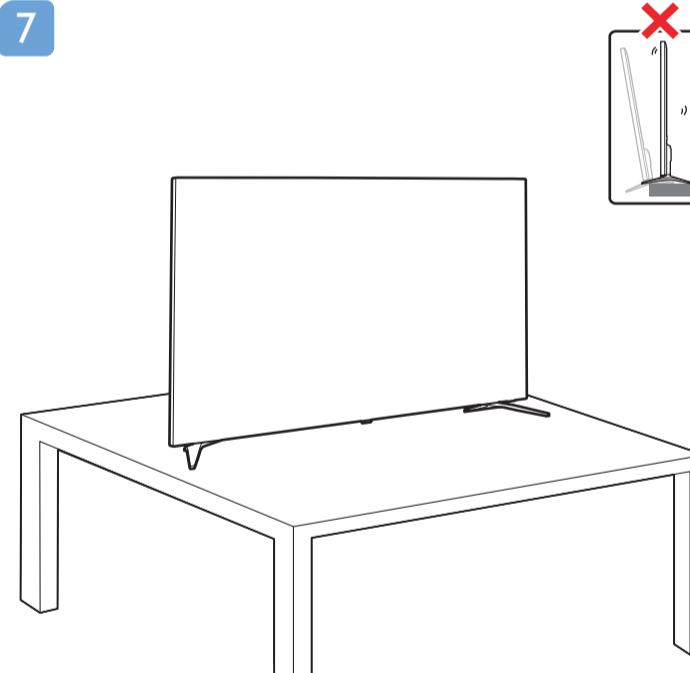

B

1

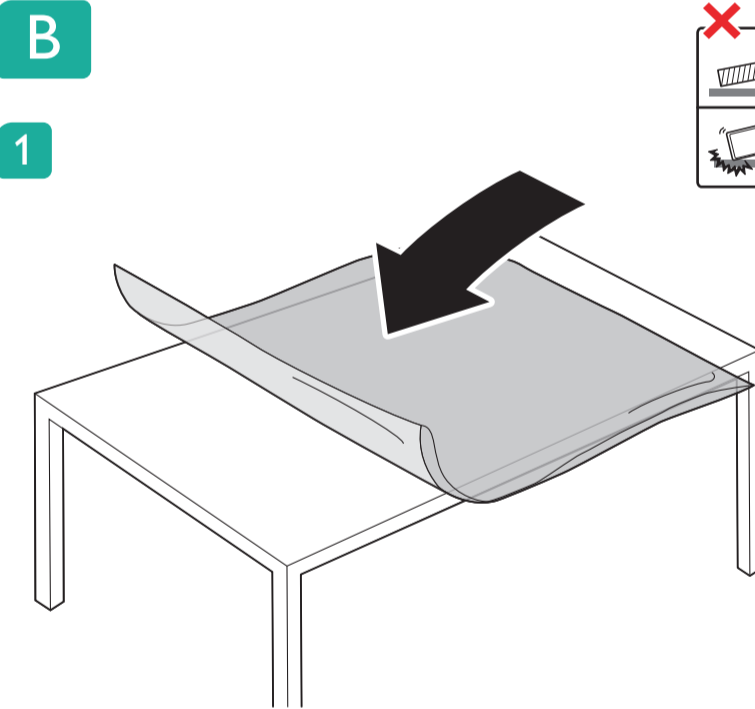

2

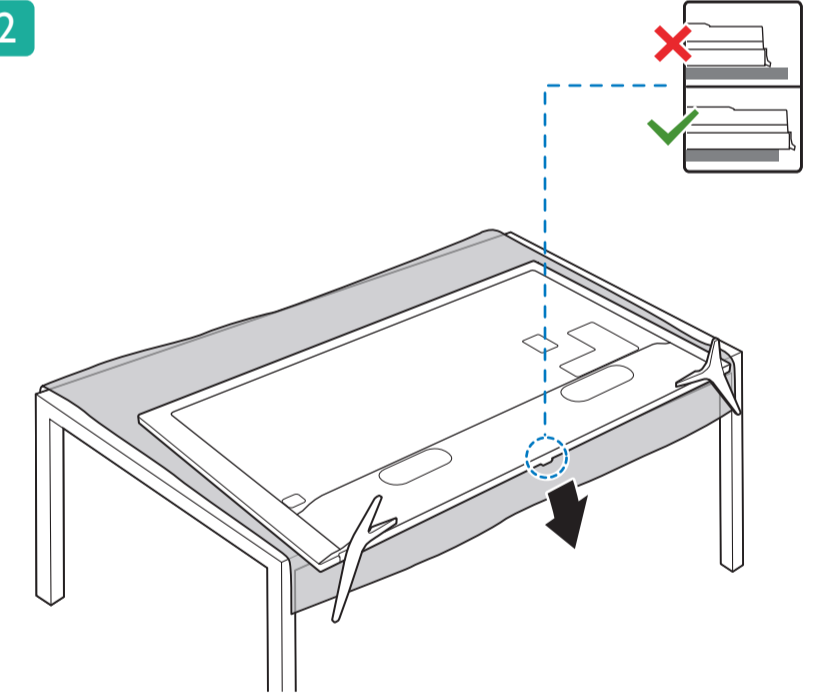

3

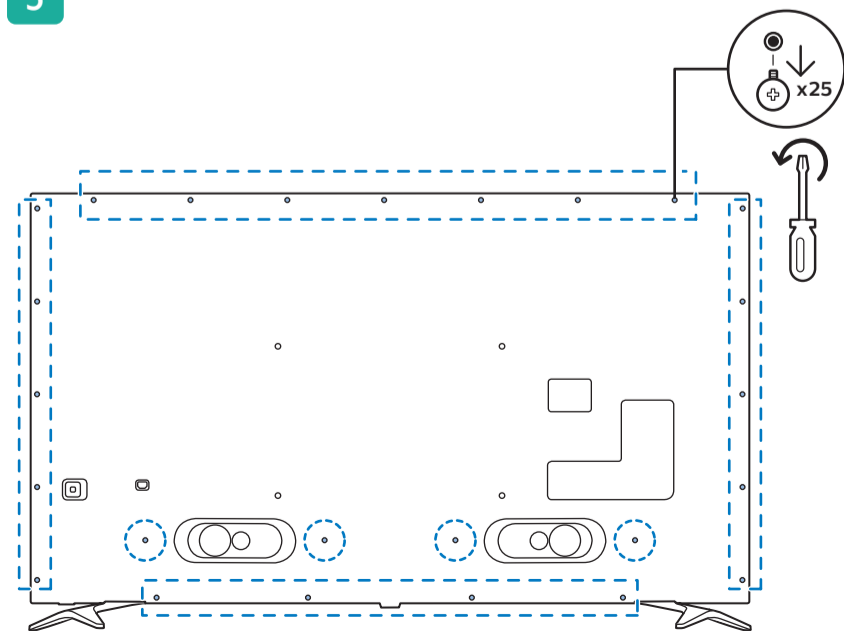

4

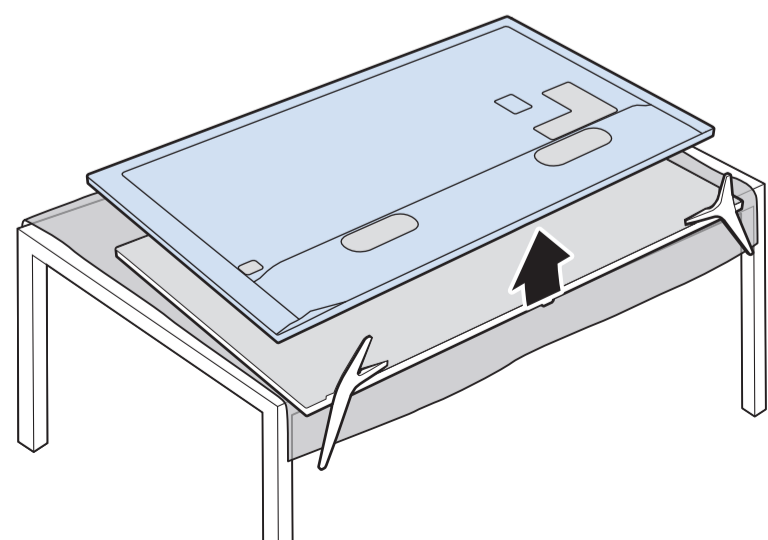

5

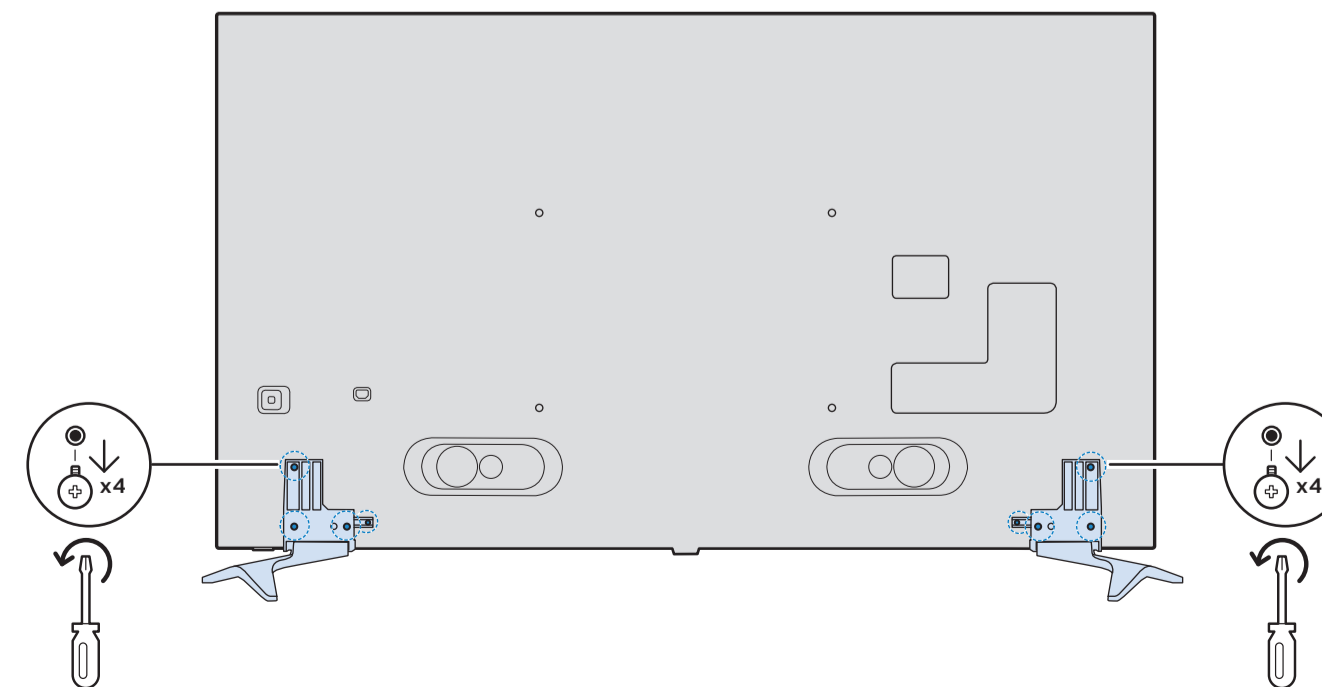

6

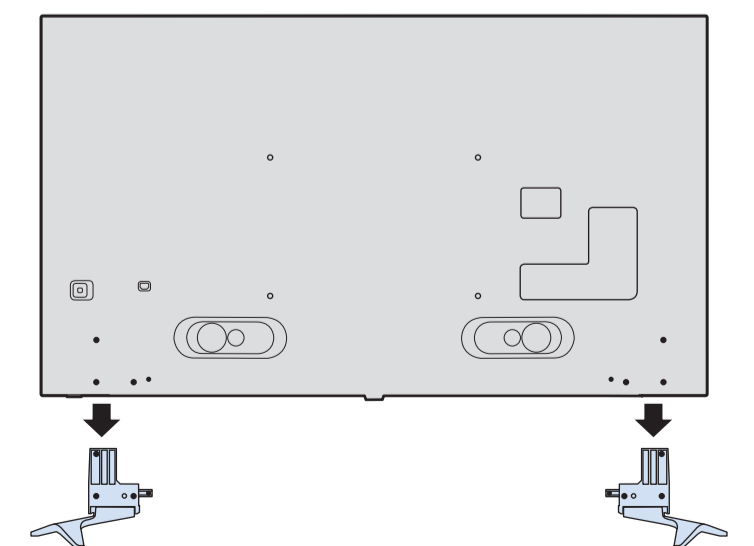

7

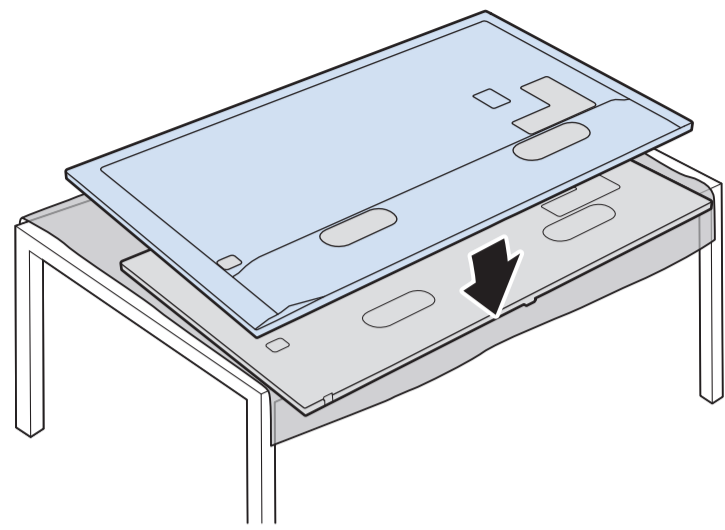

VESA (x, y)

86" 600x400mm M8 217 cm

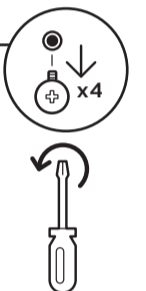
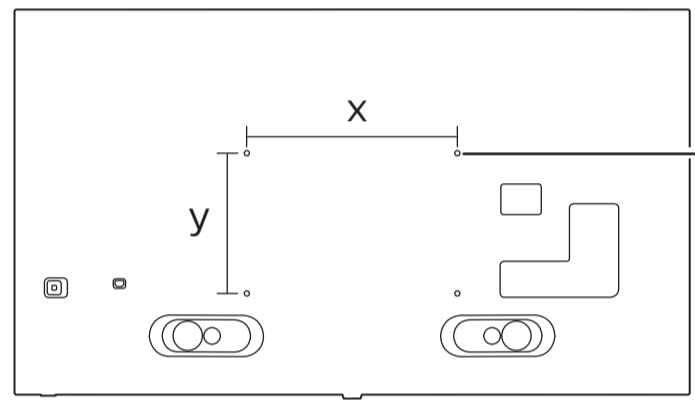

8

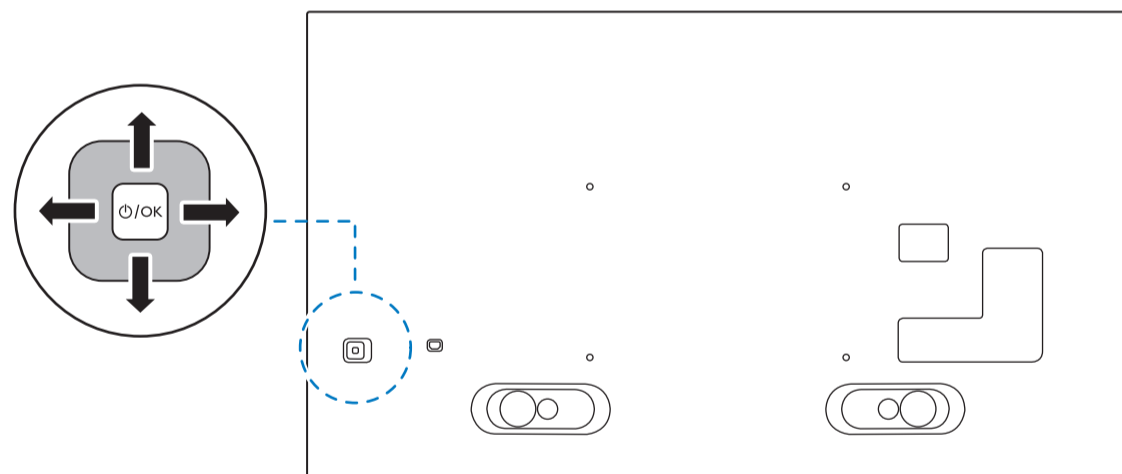
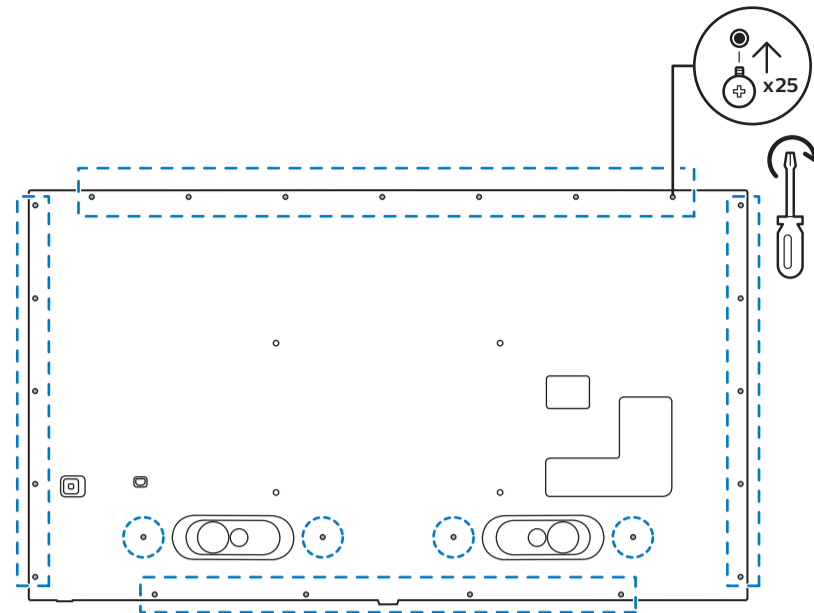

繁體中文 請閱讀安全說明。

此機種無附上紙本使用手冊，請使用以下網址輸入機種型號搜尋後自行下載。

*使用手冊包含限用物質標示說明。

www.philips.com/TVsupport

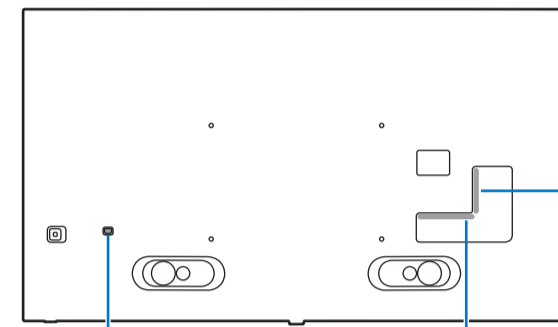
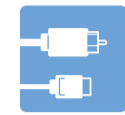
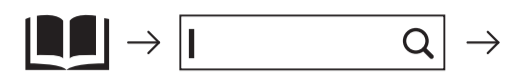

USB 1
5.0V⎓500mA

USB 2
5.0V⎓900mA

HDMI 1/2

電源

影像/聲音輸入

AV L R

SPDIF

有線網路

HDMI 3
(ARC)

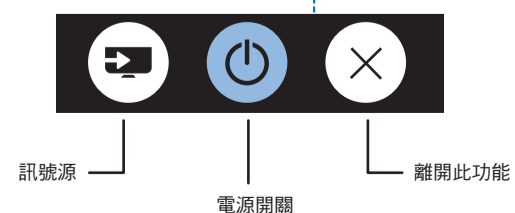
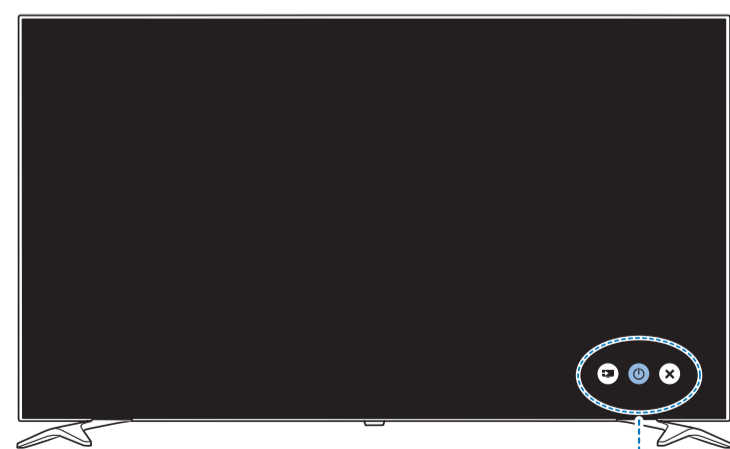
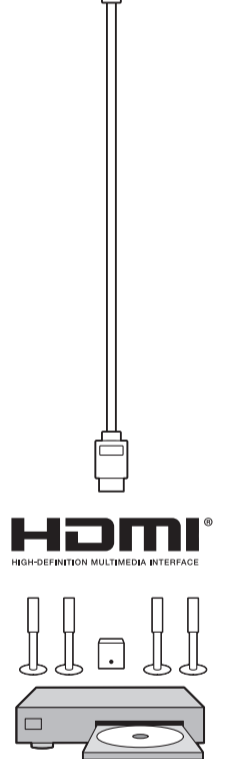
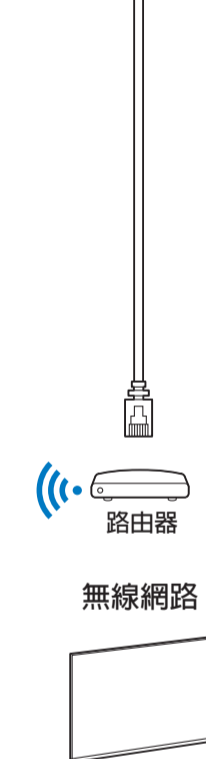
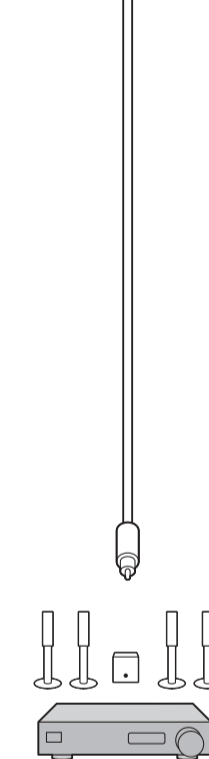
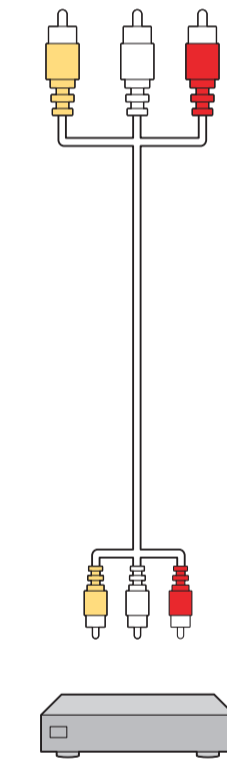
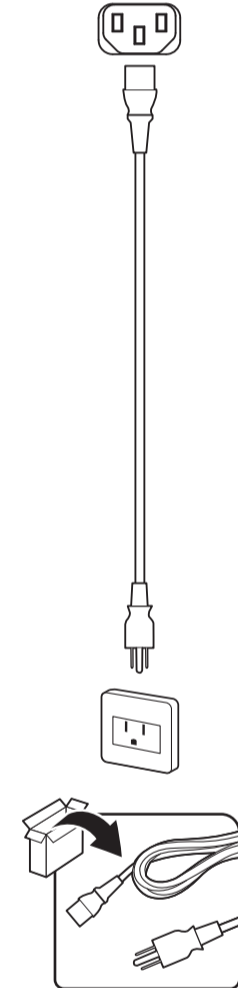

訊號源

電源開關

離開此功能

設備名稱：Philips LED背光智慧型顯示器
型號（型式）：86PUH8504/96

單元	限用物質及其化學符號					
	鉛 (Pb)	汞 (Hg)	鎘 (Cd)	六價鉻 (Cr ⁶⁺)	多溴聯苯 (PBB)	多溴二苯醚 (PBDE)
塑料外框	○	○	○	○	○	○
後殼	○	○	○	○	○	○
液晶面板	-	○	○	○	○	○
電路板組件	-	○	○	○	○	○
底座	○	○	○	○	○	○
電源線	-	○	○	○	○	○
其他線材	-	○	○	○	○	○
喇叭	-	○	○	○	○	○

備考1. "○" 係指該項限用物質之百分比含量未超出百分比含量基準值。
備考2. "-" 係指該項限用物質為排除項目。

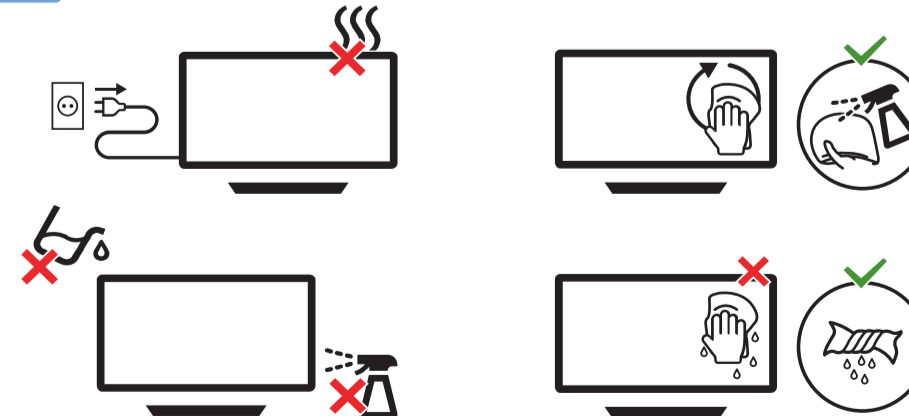

所有註冊和未註冊的商標是其各自所有者的財產。
規格如有變更，恕不另行通知。
Philips 和 Philips 盾牌圖形是Koninklijke Philips N.V. 的註冊商標。
其使用需遵循Koninklijke Philips N.V. 的許可。
2019 © TP Vision Europe B.V. All rights reserved.
www.philips.com