

Table of contents

1 Important 3

- 1.1 Safety 3
- 1.2 Care of the screen 3
- 1.3 Recycling 3

2 Your TV 4

- 2.1 Television overview 4
- 2.2 Product highlights 5

3 Getting started 5

- 3.1 Position the TV 5
- 3.2 VESA 6
- 3.3 Remote control batteries 6
- 3.4 Antenna cable 6
- 3.5 Connect the mains 6
- 3.6 First time installation 6

4 Use your TV 7

- 4.1 Switch on or off - Standby 7
- 4.2 Watch TV 8
- 4.3 Watch channels from a digital receiver 8
- 4.4 Watch connected devices 8
- 4.5 Watch a DVD 9
- 4.6 Select a Teletext page 9
- 4.7 Change Ambilight mode 9

5 Use more of your TV 10

- 5.1 Remote Control overview 10
- 5.2 TV menu overview 11
- 5.3 Picture and sound settings 13
- 5.4 Ambilight 16
- 5.5 Teletext 17
- 5.6 Create favourite channel lists 18
- 5.7 Timers and locks 18
- 5.8 Subtitles 19
- 5.9 View and play photos, MP3... 20
- 5.10 Software update 22

6 Channel installation 24

- 6.1 Automatic channel installation 24
- 6.2 Manual channel installation 25
- 6.3 Rearrange stored channels 25
- 6.4 Automatic channel management 26
- 6.5 Factory settings 26

7 Connections (DVD, receiver, ...) 27

- 7.1 Connections overview 27
- 7.2 About connecting 28
- 7.3 Connect your devices 30
- 7.4 Connections setup 35

8 Technical data 36

9 Troubleshooting 37

10 Index 39

Register your product and get support at
www.philips.com/welcome.

2007 © Koninklijke Philips Electronics N.V. All rights reserved. Specifications are subject to change without notice. Trademarks are the property of Koninklijke Philips Electronics N.V. or their respective owners.

Philips reserves the right to change products at any time without being obliged to adjust earlier supplies accordingly. The material in this manual is believed adequate for the intended use of the system. If the product, or its individual modules or procedures, are used for purposes other than those specified herein, confirmation of their validity and suitability must be obtained. Philips warrants that the material itself does not infringe any United States patents. No further warranty is expressed or implied.

Warranty

No components are user-serviceable. Do not open or remove covers to the inside of the product. Repairs may only be done by Philips Service Centres and official repairshops. Failure to do so shall void any warranty, stated or implied. Any operation expressly prohibited in this manual, any adjustments, or assembly procedures not recommended or authorised in this manual shall void the warranty.

Pixel characteristics

This LCD product has a high number of colour pixels. Although it has effective pixels of 99,999% or more, black dots or bright points of light (red, green or blue) may appear constantly on the screen. This is a structural property of the display (within common industry standards) and is not a malfunction.

Open source software

This television contains open source software. Philips hereby offers to deliver or make available, upon request, for a charge no more than the cost of physically performing source distribution, a complete machine-readable copy of the corresponding source code on a medium customarily used for software interchange.

This offer is valid for a period of 3 years after the date of purchase of this product. To obtain the source code, write to Philips Innovative Applications N.V. Ass. to the Development Manager Pathoekeweg 11 B-8000 Brugge Belgium

Compliance with EMF

Koninklijke Philips Electronics N.V. manufactures and sells many products targeted at consumers, which, like any electronic apparatus, in general have the ability to emit and receive electromagnetic signals. One of Philips' leading Business Principles is to take all necessary health and safety measures for our products, to comply with all applicable legal requirements and to stay well within the EMF standards applicable at the time of producing the products. Philips is committed to develop, produce and market products that cause no adverse health effects.

Philips confirms that if its products are handled properly for their intended use, they are safe to use according to scientific evidence available today.

Philips plays an active role in the development of international EMF and safety standards, enabling Philips to anticipate further developments in standardisation for early integration in its products.

Copyrights



VESA, FDMI and the VESA Mounting Compliant logo are trademarks of the Video Electronics Standards Association.



Manufactured under license from Dolby Laboratories. 'Dolby', 'Pro Logic' and the double D symbol **DD**, are trademarks of Dolby Laboratories.



Manufactured under license from BBE Sound, Inc. Licensed by BBE, Inc under one or more of the following US patents: 5510752, 5736897. BBE and BBE symbol are registered trademarks of BBE Sound Inc.

® Kensington and MicroSaver are registered US trademarks of ACCO World Corporation with issued registrations and pending applications in other countries throughout the world. All other registered and unregistered trademarks are the property of their respective owners.

® Windows Media is either a registered trademark or trademark of Microsoft Corporation in the United States and/or other countries.

1 Important

Read this user manual before you start to use this product.

Pay attention to this section and closely follow the instructions. The warranty does not apply to damage caused by not taking into account the instructions.

1.1 Safety

- To avoid short circuit, do not expose the product to rain or water.
- To avoid a risk of fire or electric shock do not place naked flame sources (e.g. lighted candles) close to the TV.
- Leave a space of at least 10cm (4 inches) all around the TV for ventilation.
- Keep away from radiators or other heat sources.
- Do not install the TV in a confined space such as a book case. Make sure that curtains, cupboards and so on cannot obstruct the air flow through the ventilation slots.
- Make sure the TV can not fall down. Place the TV on a solid and flat surface and only use the stand provided with the TV.
- To prevent damaging the mains cord which may cause a fire or electric shock, do not place the TV on the cord or anything else that can pinch the cord.
- When mounted on a swivel stand or VESA wall bracket avoid force coming on the mains plugs. Partly loosened mains plugs can cause arcing or fire.

1.2 Care of the screen

- Unplug the TV before cleaning.
- Clean the surface with a soft damp cloth. Do not apply any other substance (chemical or household cleaning agent). This may damage the screen.
- Do not touch, push or rub or strike the screen with anything hard as this may scratch, mar or damage the screen permanently.
- To avoid deformations and colour fading, wipe off water drops as soon as possible.

- Stationary images
Avoid stationary images as much as possible. If you can not, reduce screen contrast and brightness to prevent damage to the screen. Stationary images are images that remain on the screen for a long time. Examples of stationary images are: on screen menus, teletext pages, black bars, stock market information, TV channel logos, time displays, and so on.

1.3 Recycling

- Take the packaging to your local recycling centre.
- Dispose old batteries safely according local regulations.
- This product is designed and manufactured for material recycling and re-use.
- This product should not be disposed with other household waste. Inform yourself or ask your dealer about local environmentally safe recycling and local regulations. Uncontrolled waste disposal harms the environment and human health. (EEC 2002/96/EC)



2 Your TV

This section gives you an overview of the controls and functions of this TV.

2.1 Television overview

Side controls

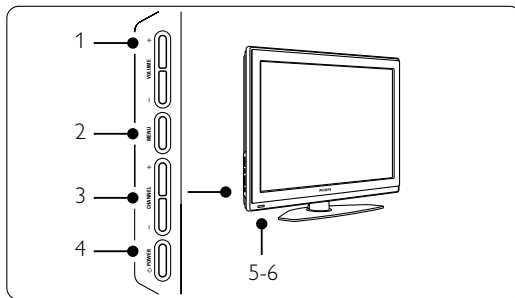

- 1 Volume up and down
- 2 Menu
- 3 Program or Channel up and down
- 4 Power switch
- 5 Led indicator (Blue: On; Red: Standby)
- 6 Remote control sensor

Side connectors

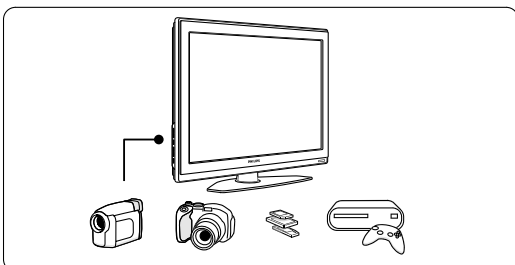

To connect a camera, game console, headphone or a USB memory device.

Back connectors

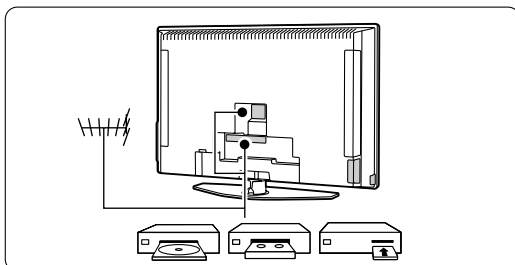

To connect the antenna, DVD, VCR or other device.

Remote control

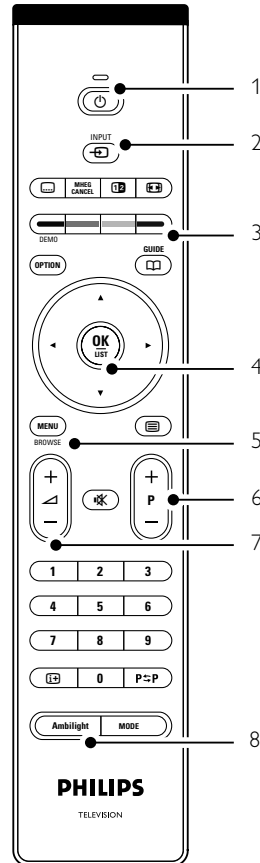

- 1 Standby or On
- 2 DVD, VCR, ... device selection
- 3 Colour keys
- 4 Navigation key (up ▲, down ▼, left ◀, right ▶) OK and LIST
- 5 Menu key
- 6 Programme up or down
- 7 Volume up or down
- 8 Ambilight on or off

Find more on your remote control in section 5.1 **Remote control overview.**

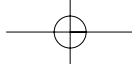

2.2 Product highlights

Your new TV is equipped with some of the most modern audio or video innovations. Your TV offers the following advantages ...

Full High Definition LCD display

A full HD resolution of 1920x1080p, the highest resolution HD broadcast can transmit. It offers a brilliant flicker-free progressive scan picture with optimum brightness and superb colours.

Ambilight

For a more relaxed viewing experience and improved perceived picture quality.

Perfect Pixel HD

Offers perfect picture quality from any source.

100 Hz Clear LCD

Results in superior sharpness of motion reproduction, better black level, high contrast with a flicker free, quiet image and a larger viewing angle.

HDMI connectors

3 HDMI connectors for highest quality high definition connectivity.

USB connection

Multimedia connection for instantly view or play your photos or music.

3 Getting started

This section helps you with the positioning and the first time installation of the TV.

3.1 Position the TV

Warning

Carefully read the safety precautions in section 1.1 **Safety** before you position the TV.

Large screen TVs are heavy. Carry and handle the TV with at least two persons.

Connect your devices first before you position your TV or mount it on the wall.

The ideal viewing distance for watching TV is three times its screensize.

For ideal viewing conditions, position the TV where light does not fall directly on the screen.

Best Ambilight effect is watched in a room with dimmed lighting conditions.

For the best Ambilight effect, position the TV 10 to 20 cm away from the wall. Position the TV where sunlight does not fall directly on the TV.

Kensington Security Slot

Your TV is equipped with a Kensington Security Slot at the back of the TV for an anti-theft lock.

An anti-theft Kensington lock has to be purchased separately.

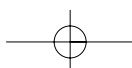
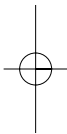
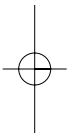
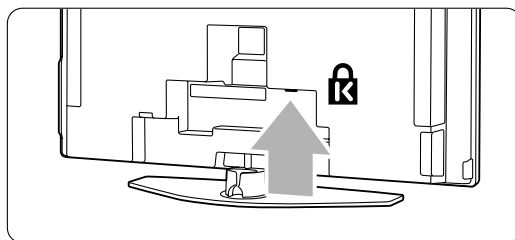

3.2 VESA compliant mounting

⚠ Caution

Use a VESA compliant bracket that meets safety standards according to the TV's weight. Closely follow the instructions that come with your VESA compliant bracket to mount the TV.

Koninklijke Philips Electronics N.V. bears no responsibility for improper mounting or mounting that results in accident or injury.

The TV is prepared for VESA compliant mounting. This bracket is not included. Use a VESA compliant bracket with code **VESA MIS-F, 600, 400, 8.**

Prepare the TV for VESA compliant mounting.

- 1 Locate the VESA screwholes on the back of the TV.

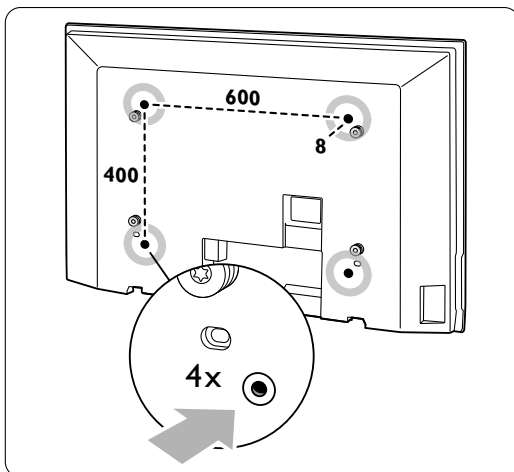

- 2 Should the plastic discs obstruct the VESA bracket, you can unscrew these 4 discs.

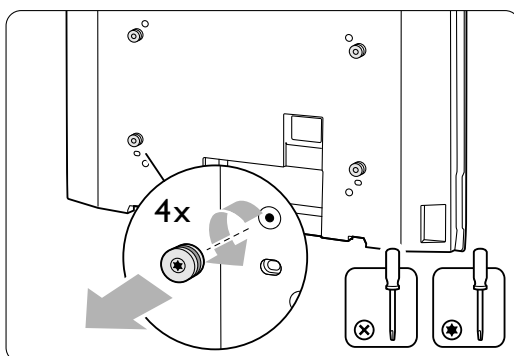

3.3 Remote control batteries

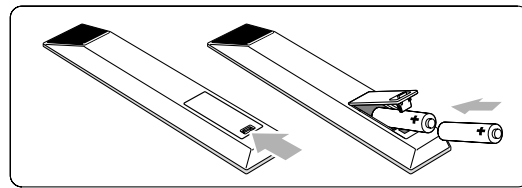

- 1 Open the battery cover on the back of the remote control.
- 2 Insert the 2 batteries supplied (Type AA-R6-1,5V). Make sure the + and - ends of the batteries line up correctly (inside of case is marked.)
- 3 Close the cover.

ⓘ Note

Remove the batteries if you don't use the remote control for a long time.

3.4 Antenna cable

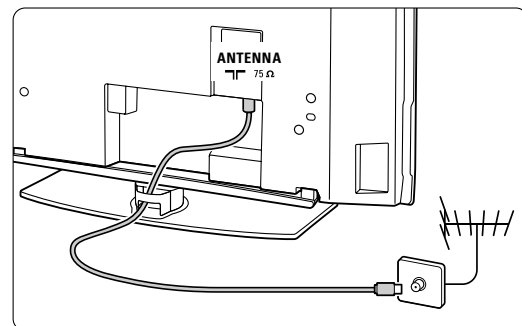

- 1 Locate the antenna connection at the back of the TV.
- 2 Insert the antenna cable tightly into the antenna socket **Antenna**.

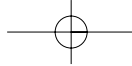

3.5 Connect the mains cord

- 1 Verify that your mains voltage corresponds with the voltage printed on the sticker at the back of the TV. Do not insert the mains cord if the voltage is different.
- 2 Insert the mains cord tightly.

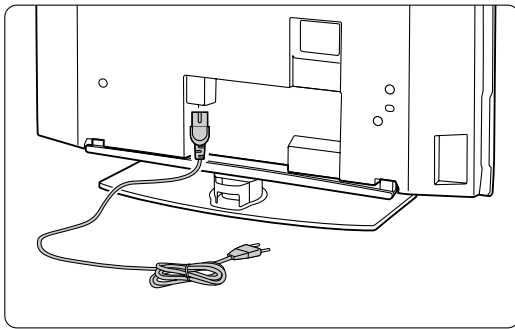

The TV is never powered off completely unless the mains cord is physically unplugged. Therefore the mains plug must be accessible at all time.

3.6 First time installation

The first time, and only the first time, the mains cord is inserted, the installation procedures starts up automatically. Follow the instructions on screen.

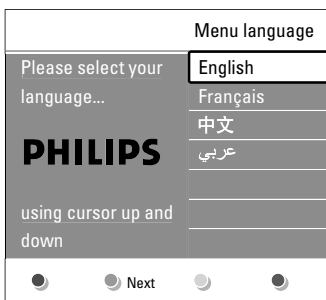

⚡ Tips

- If you notice you have selected a wrong language, press the red key on the remote control to return to the language selection menu.
- To rearrange the stored channels, see section 6.3 **Rearrange stored channels.**

4 Use your TV

Learn how to operate your TV for daily use.

4.1 Switch on or off - Standby

To switch on the TV:

- Press **Power** at the right side of the TV if the standby led is off.
- Press **Power** on the remote control if the standby led is on.

To switch to standby:

- Press **Power** on the remote control.

To switch on from standby without remote control:

- Press **Power** at the side of the TV to switch off first and press **Power** again to switch on.

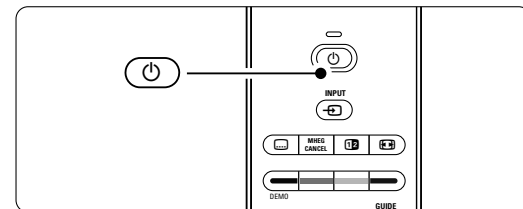
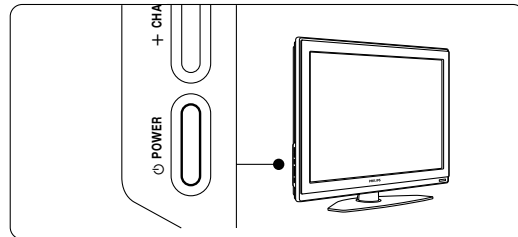

To switch off:

- Press **Power** at the side of the TV.

⚠ Note

Energy consumption contributes to air and water pollution. As long as the mains cord is plugged in, the TV consumes energy. This TV has a very low standby power consumption.

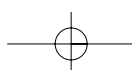
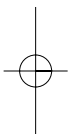
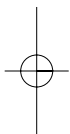

4.2 Watch TV

4.2.1 Switch channels

- 1** To switch TV channels:
 - Press a number or press **P+** or **P-** on your remote control.
 - Press **Program/Channel -** or **+** on the side controls of the TV.
- 2** Press **P=P** to return to the previously viewed TV channel.

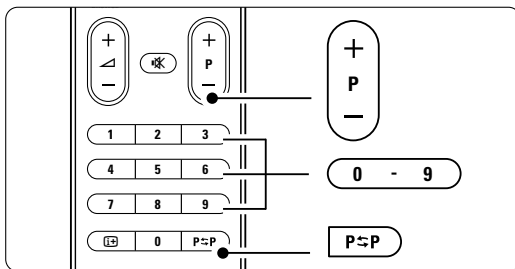

4.2.2 Adjust volume

- 1** To adjust the volume:
 - Press **+ or -** on the remote control
 - Press **Volume + or -** on the side controls of your TV.
- 2** To mute the sound:
 - Press **mute** on the remote control
 - Press **mute** again to restore the sound.

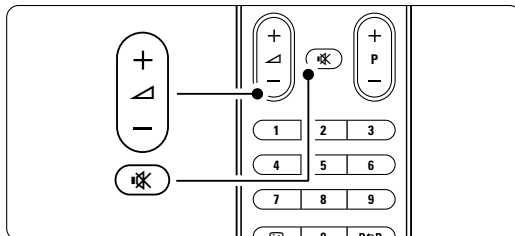

4.3 Watch channels from a digital receiver

- 1** Switch on the digital receiver.
The picture from your receiver might appear automatically on your screen.
- 2** Use the remote control of your digital receiver to select TV channels.

If the picture does not appear:

- 1** Press **INPUT** on the remote control.

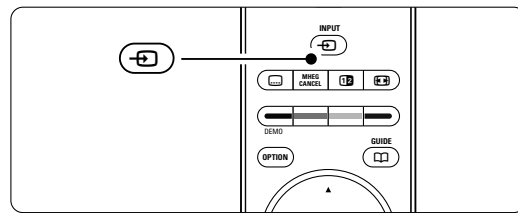

- 2** Press **INPUT** repeatedly to select the device. Wait a few seconds until the picture appears.
- 3** Press **OK**.
- 4** Use the remote control of the digital receiver to select TV channels.

4.4 Watch connected devices

- 1** Switch on the device.
The picture from your device might appear automatically.

If the picture does not appear:

- 2** Press **INPUT** on the remote control.
- 3** Press **INPUT** repeatedly to select the device. Wait a few seconds until the picture appears.
- 4** Press **OK**.
- 5** Use the remote control of your device to select TV channels.

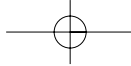

4.5 Watch a DVD

- 1 Insert a DVD disc in your player.
 - 2 Press **Play** ►.
- The picture from your player appears automatically on your screen.

If the picture does not appear:

- 1 Press **Input** on the remote control.

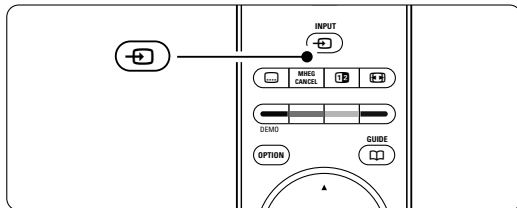

- 2 Press **Input** repeatedly to select the DVD player. Wait a few seconds until the picture appears.
- 3 Press **OK**.
- 4 Press **Play** ►.

4.6 Select a Teletext page

TV channels often broadcast information via Teletext. If Teletext is available only English Teletext is supported. China does not support this function due to no Teletext available.

To watch Teletext:

- 1 Press **Menu**.
- The main index page appears.

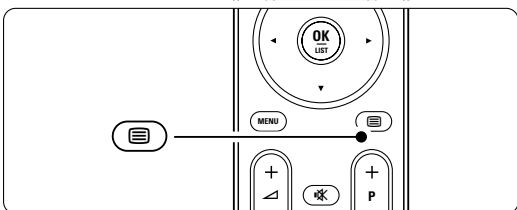

- 2 To select a page of your choice:
 - Enter the page number with the number keys.
 - Press **P-** or **P+** or **▲**, **▼** to view the next or the previous page.
 - Press a colour key to select one of the colour coded items at the bottom of the screen.

Tip

Press **P↔P** to return to the previously viewed page.

- 3 Press **Menu** again to switch Teletext off.

For more information on teletext, see section 5.5 Teletext.

4.7 Change Ambilight mode

You can choose among four Ambilight modes:

- **Colour**
Sets Ambilight to a constant colour.
- **Relaxed**
Sets Ambilight to change soft and smoothly with the images on screen.
- **Moderate**
Sets Ambilight between Relaxed and Dynamic.
- **Dynamic**
Sets Ambilight to change quick and responsive.

To change the Ambilight mode:

- 1 Press **Ambilight** to switch on or off.
- 2 Press **Mode** repeatedly to toggle through the Ambilight modes.
- 3 Press **OK**.

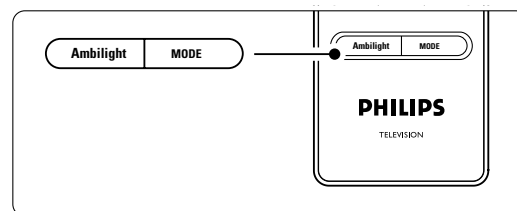

For more information on Ambilight, see section 5.4 Ambilight.

Tip

To fully enjoy Ambilight, switch off or dim the room lights.

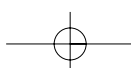
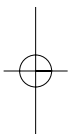
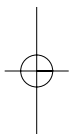

5 Use more of your TV



This section deals with the more advanced use of your TV:

- how to use the menus
- to adjust the picture, sound and Ambilight settings
- more about Teletext, if available.
- how to create favourite channel lists
- how to set locks and timers
- to set subtitles and select a subtitle language
- how you can view your photos or play your favourite music from a USB memory device.

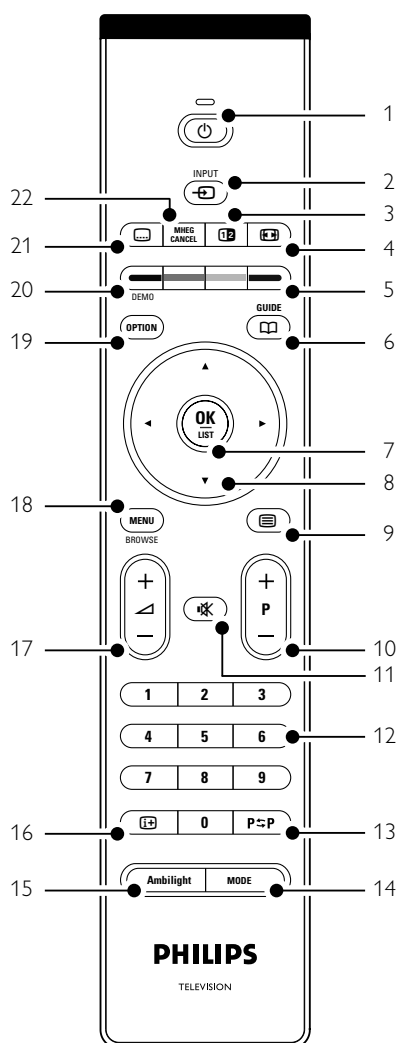
5.1 Remote control overview



- Standby** To switch the TV on or back to standby.
- Input** To select a connected device or to return to TV.
- Dual screen** To show teletext on the right and the picture on the left of the screen.
- Widescreen Picture format** To select a picture format.
- Colour keys**
 - Easy selection of teletext pages.
 - Easy selection of tasks.
- Guide** no function
- OK/List**
 - To display the channel list.
 - To activate a setting.
- Navigation keys** To navigate the menu.
- Teletext** To switch teletext on or off, if available.
- +P- Channel up or down** To switch to the next or previous channel in the channel list.
- Mute** To mute the sound or restore it.
- Number keys** To select a TV channel.
- Previous channel** To return to the previously viewed channel.
- Mode** To toggle through the Ambilight modes
- Ambilight** To switch Ambilight on or off.
- On screen information** To show channel or programme information if available.

- 17 **Volume up or down**  To adjust the volume.
- 18 **Menu** To switch the menu on or off.
- 19 **Option** To switch the Quick access menu on or off.
- 20 **Demo** To switch the Demo menu on and to get a demonstration of the features of the TV.
- 21 **Subtitles**  To activate or deactivate the subtitle mode.
- 22 **MHEG cancel** no function

See section **10 Index** to find the section in the manual about a specific remote control key.

5.2 TV menu overview

With the on screen menus you install your TV, adjust picture, sound and Ambilight settings and access features. This section gives an overview of the menus and describes how to navigate.

5.2.1 The menu

- 1** Press **Menu** on the remote control to show the main menu.
- 2** Press **Menu** to quit the menu.

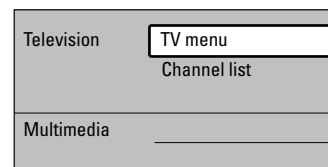
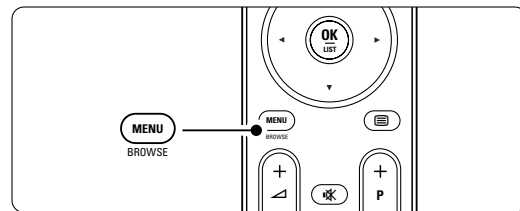

The main menu offers the following items:

- **TV menu**
Select this menu for installation, picture and sound settings, Ambilight and other feature settings.
- **Channel list**
Select this item to show the Channel list. Create your Favourite channel lists here.
- **Multimedia**
Select this item to view photos or play music stored on a USB device. See section **5.9 View and play photos, MP3, ...**

5.2.2 Use of the menu

Learn to use the menus with this example.

1 Press **Menu** on the remote control.

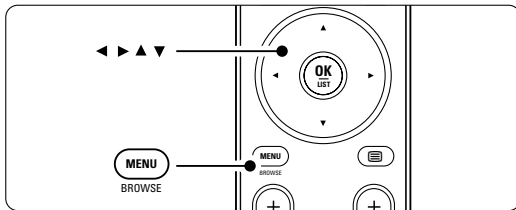

The main menu appears on the screen.

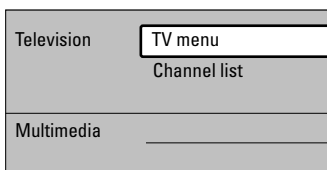

2 Press **▶** to enter the TV menu.

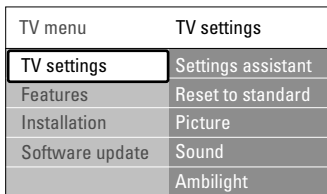

3 Press **▶** to enter the TV settings menu.

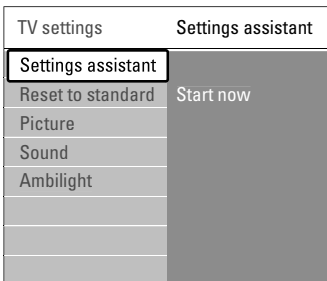

4 Press **▼** to select **Picture**.

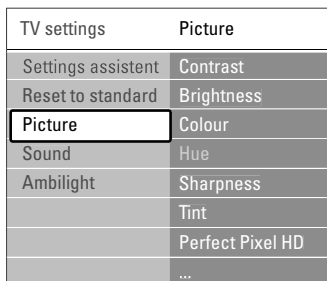

5 Press **▶** to enter the picture settings.

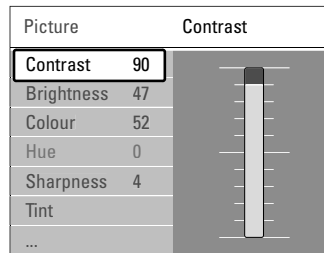

6 Press **▼** to select **Brightness**.

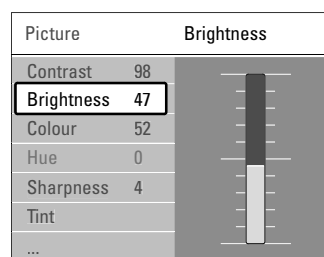

7 Press **▶** to enter the Brightness setting.

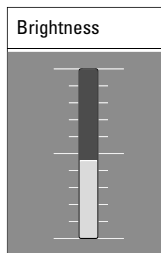

8 Press **▲** or **▼** to adjust the setting.

9 Press **◀** to return to the Picture settings or press **Menu** to quit the menu.



5.2.3 Quick access menu

The Quick access menu gives direct access to some often needed menu items.

- 1 Press **Option** on the remote control.
- 2 Press **▲** or **▼** to select an option.
- 3 Press **OK** to show the selected option menu.
- 4 Press **▲**, **▼**, **◀**, **▶** to adjust the settings in the menu.
- 5 Press **Option** to quit the menu.

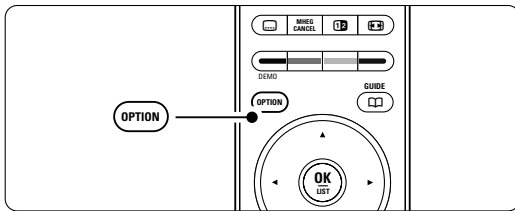

- **Subtitles**
See section 5.8 Subtitles.
- **Picture format**
See section 5.3.4 Widescreen picture format.
- **Equalizer**
See section 5.3.5 Sound settings.
- **Clock**
Not applicable in case of no Teletext present.

Display the clock

- 1 Press **OK** to display the clock permanently.
- 2 Press **Option** and press **▲** or **▼** to select Clock again.
- 3 Press **OK** to hide the clock.

Quick access
Subtitle
Picture format
Equalizer
Clock

5.3 Picture and Sound settings

This section describes how to adjust picture and sound in the menus.

ENGLISH

5.3.1 Settings assistant

Use the Settings assistant to guide you through basic picture, sound and Ambilight settings in an easy way.

- 1 Press **Menu** on the remote control and select TV menu > TV settings > **Settings assistant** and press **▶** to enter.
- 2 Press **OK**.
- 3 Press the green key on the remote control to start the assistant.
- 4 Press **◀** or **▶** to select the left or right side to make your choice.
- 5 Press the green key to go to the next setting. You will go through several settings. When finished the TV will ask you to store these settings.
- 6 Press the green key to store all your settings.
- 7 Press **Menu** to quit the menu.

5.3.2 Reset to standards

Sets the TV to one of the predefined settings. Each setting combines picture, sound and Ambilight.

- 1 Press **Menu** on the remote control and select TV menu > TV settings > **Reset to standard** and press **▶** to enter the list.
- 2 Press **▲** or **▼** to select a setting.
- 3 Press the green key to store your selection.
- 4 Press **Menu** to quit the menu.

Standard settings: Current, Natural, Vivid, Movie

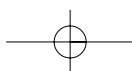

5.3.3 Picture settings

This section describes how to adjust all picture settings.

1 Press **Menu** on the remote control and select TV menu > TV settings > **Picture** and press **▶** to enter the list.

2 Press **▲** or **▼** to select a setting.

TV settings	Picture
Settings assistant	Contrast
Reset to standard	Brightness
Picture	Colour
Sound	Hue
Ambilight	Sharpness
	Tint
	Perfect Pixel HD
	HD Natural Motion
	100Hz Clear LCD
	Dynamic contrast
	Noise reduction
	MPEG artefact red.
	Colour enhanc ...
	Active control
	Light sensor
	Picture format

- **Contrast**
Changes the level of bright parts in the picture but keeps the dark parts unchanged.
- **Brightness**
Changes the level of light of the total picture.
- **Colour**
Changes the level of saturation.
- **Hue**
If NTSC is broadcasted, this level compensates the colour variations.
- **Sharpness**
Changes the level of sharpness of fine details.
- **Tint**
Sets the colours to Normal, Warm (reddish) or Cool (bluish). Select Custom to make a setting of your own in the Custom tint menu.
- **Custom tint**
If Custom is selected in the Tint menu you can make a setting of your own here.
Press the green key to select each bar to change the value of:
 - R-WP red whitepoint
 - G-WP green whitepoint
 - B-WP blue whitepoint
 - R-BL red blacklevel
 - G-BL green blacklevel

- **Perfect Pixel HD**
Enables or disables Perfect Pixel HD, the most ideal picture setting.
- **HD Natural Motion**
Reduces the field and line flicker and reproduces smooth movement especially in movies.
Set the level to Minimum, Maximum or Off.
- **100 Hz Clear LCD**
Switches 100 Hz Clear LCD on or off.
- **Dynamic contrast**
Enhances the contrast in the picture as the image on the screen changes.
Set the level to Minimum, Medium, Maximum or Off. The level medium is recommended.
- **Noise reduction**
Filters out and reduces the noise in the picture.
Set the level to Minimum, Medium, Maximum or Off.
- **MPEG artefact reduction**
Smoothens the transitions on digital pictures.
Switches MPEG artefact reduction on or off.
- **Colour enhancement**
Makes the colours more vivid and improves the resolution of details in bright colours.
Set the level to Minimum, Medium, Maximum or Off.
- **Active control**
Corrects all incoming signals in order to provide the best picture possible.
Switches Active control on or off.
- **Light sensor**
Adjusts the picture and Ambilight settings on the lighting conditions in the room.
Switches Light sensor on or off.
- **Picture format**
See section **5.3.4 Widescreen picture format**.

5.3.4 Widescreen picture format

Avoid black bars on the sides or on top and bottom of the picture. Change the picture format to a format that fills the screen.

- 1 Press **[P]** to switch on the Picture format menu.
- 2 Press **▲** or **▼** to select an available picture format.
- 3 Press **▲** to shift the picture upwards to make partly covered subtitles visible.

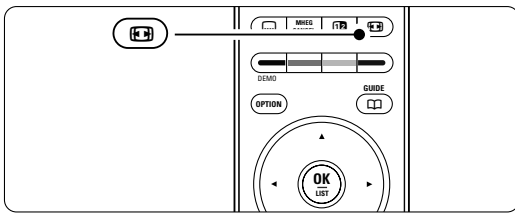

Tip

The Auto format setting is recommended for minimal distortion.

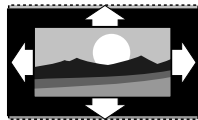

Auto format (Not for PC)
Enlarges the picture automatically to fill the screen. Subtitles remain visible.

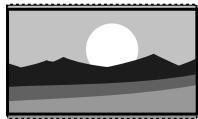

Super zoom (Not for HD)
Removes the black bars on the side of 4:3 broadcasts. There is a minimal distortion.

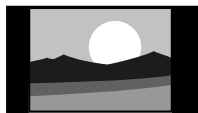

4:3 (Not for HD)
Shows the classical 4:3 format

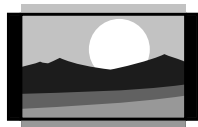

Movie expand 14:9 (Not for HD)
Scales classical 4:3 format to 14:9

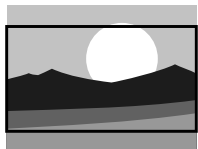

Movie expand 16:9 (Not for HD)
Scales classical 4:3 format to 16:9.

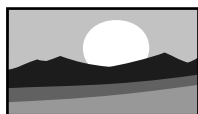

Wide screen
Stretches 4:3 format to 16:9.

Use more of your TV



Unscaled

(Only for HD and PC.)
Maximum sharpness.
Distortion may appear on borders. Black bars may appear with pictures from your PC.

Note

Do not forget to name the connection in the Connection menu. See section 7.4.3 Naming your devices.

5.3.5 Sound settings

This section describes how to adjust all sound settings.

- 1 Press **Menu** on the remote control and select TV menu > TV settings > **Sound** and press **▶** to enter the list.
- 2 Press **▲** or **▼** to select a setting.

TV settings	Sound
Settings assistant	Equalizer
Reset to standard	Volume
Picture	Balance
Sound	Dual I/II
Ambilight	Mono/Stereo
	Surround mode
	Headphone volume
	Auto volume level
	Delta volume
	Auto surround

Equalizer

Changes the bass and treble of the sound. Select each bar to change the setting. See also section 5.2.3 Quick access menu.

Volume

Changes the volume.

When adjusting the volume with **▲** a volume bar appears. If you don't want it to appear go to TV menu > Installation > **Preferences** and press **▶** to enter the list and select Volume bar off.

- 1 Press **▲** or **▼** to select **Volume bar**.
- 2 Press **▶** to enter.
- 3 Select **On** to activate the temporarily display of the volume bar when adjusting the volume.

Balance



Sets the balance of the left and right loudspeakers to fit best your listening position.

- **Dual I/II**
If broadcasted, you can choose between two different languages.
- **Mono/stereo**
If stereo broadcasting is available, you can select Mono or Stereo per TV channel.
- **Surround mode**
To select a more spatial sound if broadcasted or if available from a connected device.
- **Headphone volume**
Changes the volume of the headphone.
You can mute the TV speakers with  on the remote control.
- **Automatic volume leveller**
Reduces sudden volume differences like at the beginning of commercials or when switching from one channel to another.
Select on or off.
- **Delta volume**
Levels out volume differences between channels or connected devices.
1 Switch to the channel or device you want to level out the volume difference.
2 Select **Delta volume** in the Sound menu and change the volume level.
- **Auto surround**
Switches the TV automatically to the best surround sound mode broadcasted.
Select on or off.

- **Mode**
You can choose among four Ambilight modes: **Colour, Relaxed, Moderate, Dynamic**. See section 4.7 **Change Ambilight mode**.
- **Colour**
If Colour is selected in the Mode menu you can select a constant colour from the list or make a custom colour of your own.
 - **Warm white**
 - **Cool white**
 - **Blue**
 - **Custom**
 When Custom is selected in the Colour menu you can customise your colour:
 - 1** Select **Saturation** first and set the value high.
 - 2** Select **Palette** and slide from 0 to 100 to go from red over yellow, green to blue.
- **Separation**
Sets the level of difference in colour between the left and right side of the TV if Relaxed, Moderate or Dynamic is selected in the Mode menu.
Separation off shows a dynamic but mono colour Ambilight.
- **Colour boost**
Amplifies the colours for a more dynamic effect if Relaxed, Moderate or Dynamic is selected in the Mode menu.
- **Balance**
Like stereo sound balance, sets the level of Ambilight for the left and right side of the TV.

5.4 Ambilight

This section describes how to adjust Ambilight settings.

- 1** Press **Menu** on the remote control and select TV menu > TV settings > **Ambilight** and press  to enter the list.
- 2** Press  or  to select a setting.

TV settings	Ambilight
Settings assistant	Ambilight
Reset to standard	Brightness
Picture	Mode
Sound	Colour
Ambilight	Separation
	Colour boost
	Balance

- **Ambilight**
Switches Ambilight on or off.
- **Brightness**
Changes the light output of Ambilight.

Caution

To avoid bad infrared remote control reception, place your devices out of sight of Ambilight.

TV standby with Ambilight

When the TV is standby, you can switch Ambilight on. In this case Ambilight is only available as constant colour.

- 1** Press **Ambilight** on the remote control when the TV is in standby.
- 2** Press **Mode** repeatedly to select an available colour.

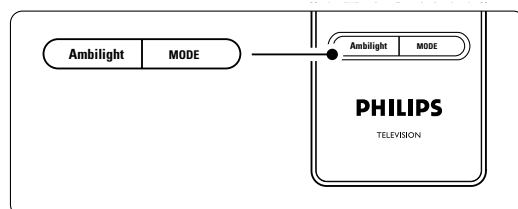

5.5 Teletext



If available only English Teletext is supported. China does not support this function due to no Teletext available.

Your TV has a 1200 pages memory that stores broadcasted teletext pages and subpages to reduce waiting time.

To select a teletext page see section 4.6 **Select a Teletext page**.



5.5.1 Select pagenumber subpages

A teletext page number can hold several subpages. The pages are shown on a bar next to the main pagenumber.

- 1 Press .
- 2 Select a teletext page.
- 3 Press  or  to select a subpage.







5.5.2 Dual screen teletext

View the TV channel and teletext next to each other.

- 1 Press  for Dual screen teletext.
- 2 Press  again to show normal teletext.
- 3 Press  to switch off teletext.



5.5.3 Search teletext

Quickly jump to a subject linked to a series of pagenumbers or search for specific words in teletext pages.

- 1 Press .
- 2 Press **OK** to highlight the first word or number.
- 3 Press ,  or ,  to jump to the next word or number on the page.
- 4 Press **OK** the search a page which holds the highlighted word or number.
- 5 Press  until no word or number is highlighted to quit Search.

5.5.4 Enlarge teletext pages

For a more comfortable reading, you can enlarge the teletext page.

- 1 Press  and select a teletext page.
- 2 Press **Option** on the remote control to enlarge the top part of the page.
- 3 Press **Option** again to view the enlarged lower part of the page.
- 4 Press  or  to scroll through the enlarged page.

- 5 Press **Option** again to return to the normal page size.



5.5.5 Teletext menu

With the options in the teletext menu you can reveal hidden info, let cycle subpages automatically and change the character setting.

- **Reveal**
Hide or unhide hidden information on a page, such as solutions to riddles or puzzles.
- **Cycle subpages**
If subpages are available for the selected page, you can make subpages cycle automatically.
- **Language**
Some languages use a different set of characters. Switch to the other group to show the text correctly.

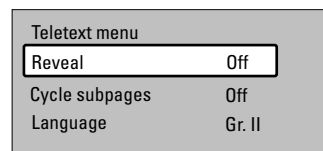
- 1 Press .
- 2 Press **Menu**.



- 3 Press  or  to select an option.
- 4 Press **OK** to change a setting.
- 5 Press **Menu** to quit the teletext menu.
- 6 Press  to switch off teletext.

5.5.6 Teletext 2.5

If broadcasted by the TV channel this teletext offers more colours and better graphics.

- Teletext 2.5 is switched on as a factory setting.
- 1 Press **Menu** on the remote control and select TV menu > Installation > Preferences > **Teletext 2.5** and press  to enter the list.
 - 2 Select on or off.

5.6 Create favourite channel lists

View the All channels list or set up a Favourite list of your own with your preferred TV channels. For example, each member of your family can create his or her own favourite list.

5.6.1 Select a favourite list

Learn how to select one of the favourite channel lists.

- 1 Press **OK**.
The first time after you have finished the installation, the All channels list is shown. In other situations, it brings up the last selected favourite list.

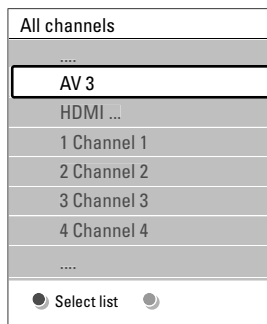

- 2 Press the red key to show all favourite lists.
- 3 Press **▲** or **▼** to select a list.
- 4 Press **OK**.
The selected favourite list appears.
- 5 Press **OK** again to quit.

5.6.2 To set up a favourite list

Create or modify your own favourite list.

- 1 Press **OK**.
The last selected list appears.
- 2 Press the red key to show all favourite lists.
- 3 Press **▲** or **▼** to select a list.
- 4 Press **OK**.
- 5 Press the green key to enter the Edit mode.
The selected list brings up a full channel list.
- 6 Press **▲** or **▼** to highlight a channel.
- 7 Press **OK** to mark (or unmark) the highlighted channel.
The channel is added to (or removed from) the selected list.
- 8 Press the green key again to leave the Edit mode.
The modified channel list appears again.

5.6.3 Select a channel from a favourite list

- 1 Press **OK**.
The last selected channel list appears.
- 2 Use **▲** or **▼** to highlight a channel.
- 3 Press **OK**.
The TV tunes to that channel.

Tip

- Use **-P+** to go through the TV channels of the selected favourite list.
- With the number keys you can still select channels which are not marked as favourite.

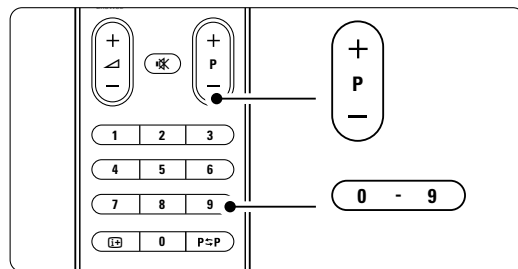

5.7 Timers and locks

This section describes how to switch the TV on or off at a specified time and to lock or unlock the TV.

5.7.1 Automatically switch to standby

Sleeptimer switches the TV to standby after a time.

- 1 Press **Menu** on the remote control and select **TV menu > Features > Sleptimer** and press **▶** to enter the sleeptimer bar.
- 2 Press **▲** or **▼** to set the time up to 180 minutes in steps of 5 minutes. If set to 0 minutes, the Sleptimer is switched off.

You can always switch off your TV earlier or reset the time during countdown.

5.7.2 Automatically switch the TV on

Not applicable in case of no Teletext present.

On timer switches the TV on automatically to a specified channel at a specified time, from standby.

- 1 Press **Menu** on the remote control and select **TV menu > Features > On timer** and press **▶** to enter the On timer menu.
- 2 Use **▲** or **▼**, **◀** or **▶** to select and enter the menu items one by one to set a channel, a day of the week or daily, and a starting time.

- 3 Press **OK** to confirm.
- 4 Press **Menu** to quit the menu.

Tip

To switch off the On timer, select **Off** in the On timer menu.

5.7.3 Lock TV channels and programmes

Lock TV channels and/or programmes from connected devices to prevent children from watching them. Lock and unlock with a four number code.

Set or change your code

- 1 Press **Menu** on the remote control and select TV menu > Features > **Set or Change code** and press **▶** to enter your code.
- 2 Enter your code with the number keys.
The **Features** menu reappears with a message confirming that your code has been created or changed.

Did you forget your code ?

- 1 Select **Change code**.
- 2 Press **▶**.
- 3 Enter the overriding code 8-8-8-8.
- 4 Enter a new personal code.
- 5 Confirm your new entered code.
The previous code is erased and the new code is stored.

5.7.4 Activate or deactivate Child lock

If your code is set, you can lock all channels and devices, lock a specific channel or device, set a time after which all channels and devices are locked.

- 1 Press **Menu** on the remote control and select TV menu > Features > **Child lock** and press **▶** to enter your code.
- 2 Enter your code with the number keys.
- 3 Select one of the options.
- 4 Press **▶**.

Lock or unlock all channels and connected devices

- 1 Select **Lock** or **Unlock**.
- 2 Press **OK**.

Lock a certain programme or all channels from a certain time

Child lock	Custom lock
Lock	Lock after
Custom lock	Channel lock
Unlock	

- 1 Select **Custom lock**.
- 2 Press **▶** to enter the Custom lock menu.
- 3 Press **▶** again to enter the Lock after menu.
- 4 Select **On** to switch on the Timer lock.
- 5 Press **◀**.
- 6 Select **Time**.
- 7 Press **▶**.
- 8 Enter the time with **▲** or **▼** and **▶**.
- 9 Press **OK**.

Lock one or more channels and connected devices

- 1 Select **Custom lock**.
- 2 Press **▶** to enter.
- 3 Press **▲** or **▼** to select **Channel lock**.
- 4 Press **▶**.
- 5 Press **▲** or **▼** to select the channel(s) you want to lock or unlock.
- 6 Each time press **OK** to lock or unlock the channel.

5.8 Subtitles

For each TV channel, subtitles can be set, coming from Teletext.

5.8.1 Subtitling from TV channels

- 1 Select an TV channel.
- 2 Press **☰** to switch on Teletext.
- 3 Enter the three number pagenumber of the subtitle page.
- 4 Press **☰** to switch off Teletext.

Note

The Teletext subtitle page must be stored for each TV channel separately.

5.8.2 Activate or deactivate subtitling

- 1 Press **Menu** on the remote control and select TV menu > Features > **Subtitle** and press **▶** to enter the list.

TV menu	Features
TV settings	Subtitle
Features	Sleeptimer
Installation	Child lock
Software update	Set/Change code
	On timer
	Demo

- 2 Press **▲** or **▼** to select **On** to show the subtitles always or **On during mute** to show the subtitles only when the sound is muted with the **ⓧ** key on the remote control.

- 3 Press **◀** to return to the Features menu.

Tip

Select the Subtitle menu directly with **Option** on the remote control. See section 5.2.3 Quick access menu.

5.9 View and play: photos, MP3, ...

Watch pictures or listen to music stored on a USB device (not supplied with the TV). Watch your pictures as a slideshow or listen to a self made music playlist.

Note

Philips can not be held responsible if your USB device is not supported nor shall Philips accept any liability for damage or loss of stored data.

5.9.1 Insert a USB device

Insert a device at the side of the TV while the TV is switched on.

The main menu appears automatically and the name of the USB device is highlighted next to **Multimedia**.

Television	TV menu
	Channel list
Multimedia	

5.9.2 Remove the USB device

Caution

To avoid damaging the USB device always quit the menu on screen and wait five seconds before you remove the USB device.

- 1 Press **Menu** to quit the menu.
- 2 Remove the USB device.

5.9.3 View your pictures

The Multimedia menu shows the files you have stored on your USB device.

- 1 Press **▶** to enter the Multimedia menu. **Picture** is highlighted.

USB	Picture
Picture	Afrika_2001
Music	Paris_2006
	My_car.jpg
	Jean.jpg
	Mary.jpg

- 2 Press **▶** to enter the Picture folder.
- 3 Press **▲** or **▼** to select a picture or a picture album on the USB device.

Picture	Afrika_2001
Afrika_2001	Kenya.jpg
Paris_2005	Congo.jpg
My_car.jpg	Victoria.jpg
Jean.jpg	Dakar.jpg
Mary.jpg	Cairo.jpg

Afrika_2001	Afrika_2001
Kenya.jpg	 Kenya.jpg
Congo.jpg	
Victoria.jpg	
Dakar.jpg	
Cairo.jpg	

- 4 Press **OK** to view the picture or to start a slideshow of the pictures in the album.
- 5 Press **OK** to pause the slideshow. Press again to restart.
- 6 Press one of the colour keys on the remote control to perform the corresponding function shown at the bottom of the screen. Press the blue key to stop the show and to see more functions. If the function bar at the bottom disappeared, press any colour key to let it reappear.
- 7 Press **◀** and select another picture or another album.

Slideshow settings

- **Details / More details**
Shows the picture name, date, size and next picture in the slideshow.
- **Transitions**
Shows the list of available transition styles of the pictures.
Press ▲ or ▼ to select and press OK to activate.
- **Slide time**
Sets the time lag for the picture transitions:
Short, Medium or Long.
- **Rotate**
To rotate a picture.
- **Zoom**
Show a list of available zoom magnifications to select.
- **Start/Show**
To stop and restart the slideshow.

Music settings

- **Details**
Shows the file name.
- **Repeat one/all**
Repeat all songs in the album until you stop a song or only repeat the one song selected until you stop the song.
- **Shuffle**
Play songs in a random sequence.

5.9.6 Slideshow with background music

Watch a slideshow of your stored pictures accompanied with your stored background music.

- 1** Select an album of songs first and press OK.
- 2** Highlight the Picture folder and select an album of pictures and press OK.

5.9.4 Thumbnails

View the pictures of a selected album in an overview.

- 1** Select a picture album.
- 2** Press ► to enter the picture list.
- 3** Press the green key.
- 4** Press ▲ or ▼, ◀ or ▶ to highlight a picture.
- 5** Press OK to view the picture.
- 6** Press ◀ to return to the thumbnail overview.
- 7** Press the green key again to go back to the picture list.

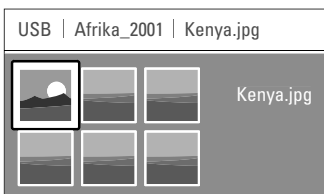

5.9.5 Listen to music

Find your songs in the Music album of the Multimedia menu.

- 1** Highlight **Music** in the Multimedia menu.
- 2** Press ► to enter the Music folder.
- 3** Press ▲ or ▼ to select a song or a music album.
- 4** Press OK to play the selected song or to play a song followed by the next song in the same album.

5.10 Software update

Philips continuously tries to improve its products. It may be recommended for you to update the TV's software. To update your TV software you need a USB Memory device (not supplied).

Note

The device must have at least 48Mb free space. Make sure the write protection is turned off. Some USB devices do not work with our TV. Contact your dealer.

5.10.1 Update assistant

The Update assistant helps you to update the TV's software.

TV identification

The TV will identify itself to your USB memory device.

- 1 Switch the TV on.
- 2 Press **Menu**.
- 3 Press **▶**.
- 4 Press **▲ ▼** to select **Software update**.
- 5 Press **▶**.

TV menu	Update assistant
TV settings	Update assistant
Features	Current software...
Installation	Local updates
Software update	

- 6 Press **▲ ▼** to select **Update assistant**.
- 7 Press **▶**.
- 8 Press **OK** to activate.
- 9 Insert a USB memory device to the USB connector at the side of the TV.
The main menu appears.
- 10 Press the green key to proceed.
A message appears the TV has successfully written the identification file to the USB memory device.
- 11 Press the green key again to finish.
- 12 Remove the USB memory device from the TV.

5.10.2 Software download from the PC to the USB device

- 1 Insert the USB memory device into a PC linked to the internet.
- 2 Locate and open the file "update.htm" on your USB device.
- 3 Read the instructions on screen and click on the **Send ID** button.
The software update is downloaded on the USB memory device.
- 4 Remove the USB memory device from your PC.

5.10.3 Transfer of the downloaded software update to the TV

The downloaded software on the USB memory device must now be uploaded to your TV.

Caution

- Do not remove the USB memory device during the software update.
- If a power drop occurs during the update, do not remove the USB memory device from the TV. The TV will continue the update as soon as the power comes back.

- 1 Insert the USB memory device to the USB connector at the side of the TV.

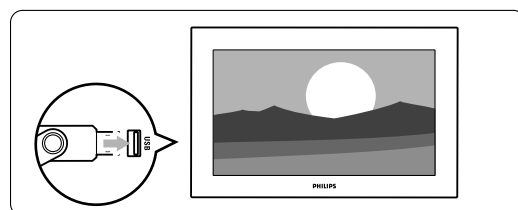

- 2 The TV switches off. The screen stays black for about 10 seconds. Wait and do not use the power switch  on the TV.

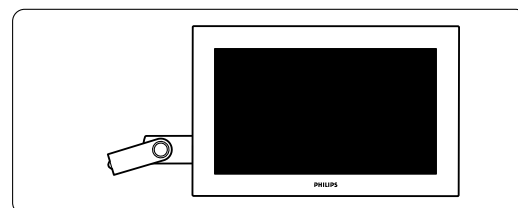

- 3** The update process starts automatically. Please wait.

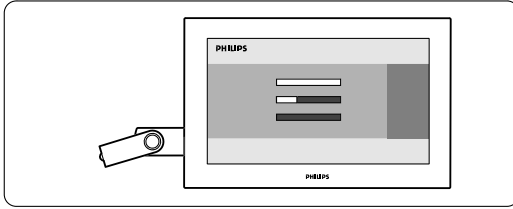

- 6** The TV switches off. The screen stays black for about 10 seconds. Please, wait.

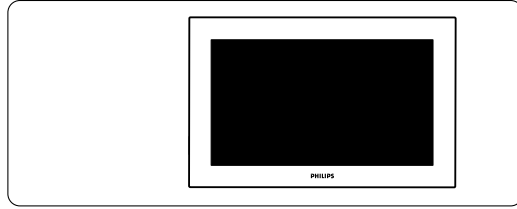

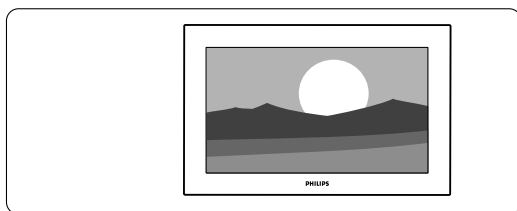
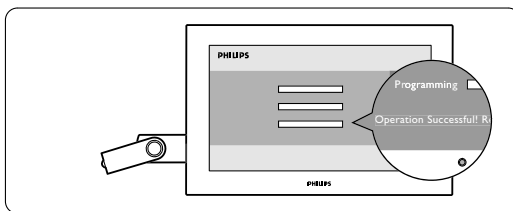

The update is finished when the message 'Operation successful' appears on the screen.

- 7** The TV switches back on again. The update is done.

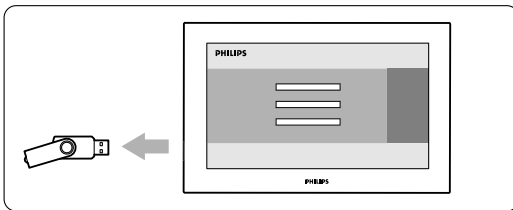

- 4** Remove the USB memory device from the TV.



- 5** Press  on the remote control.

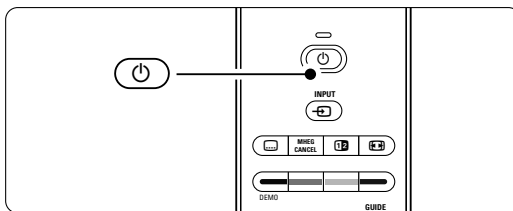

5.10.4 Verify the current software version

Updating software is only possible if the version of the new available software is different from the current one. You can verify your current software version.

- 1** Select **Software update** in the TV menu.
- 2** Press .
- 3** Press navigation key   to select **Current software info**.

The version and the description of the current software appears.

Note

Do not press more than once and do not use the **Power**  switch on the TV.

6 Channel installation

The first time you switched on your TV you've selected the language of the TV menus and all the available channels have been installed. This chapter will help you if you find it necessary to re-do the initial installation or if you want to tune in a new TV channel.

Notes:

- You do not have to follow every step described if it is not necessary.
- Re-installation will modify the All channels list and new added channels will not be added to any favourite list.

6.1 Automatic installation

This section describes how to search for and store all available channels automatically.

Step 1 Menu language

Sets the language of the TV menus. Go to a next step if your language settings are correct.

- 1** Press **Menu** on the remote control and select TV menu > Installation > **Language**.
- 2** Press **▶** to enter the menu **Language**.
- 3** Press **▲** or **▼** to select your language.
- 4** Press **OK** to confirm.
- 5** Press **◀** to return to the Installation menu.

Installation	Language
Language	<input checked="" type="radio"/> English
Channel install...	<input type="radio"/> Français
Preferences	<input type="radio"/> 中文
Connections	<input type="radio"/> عربي
Factory settings	

Step 2 Install TV channels

Your TV will search for and store all available TV channels.

- 1** Press **▼** to select **Channel installation**.
- 2** Press **▶** to enter the Channel installation menu. **Automatic installation** is highlighted.
- 3** Press **▶** to select **Start now**.
- 4** Press **OK**.
- 5** Press the green key to start.
The installation may take a few minutes.

- 6** When the channel search is completed, press the red key to return to the Installation menu.
- 7** Press **Menu** to quit the TV menu.

If you want to rename, reorder or uninstall stored channels, see section **6.3 Rearrange channels**.

6.2 Manual installation

You can tune-in TV channels channel by channel manually with Manual installation.

6.2.1 Select the system

- 1** Press **Menu** on the remote control and select TV menu > Installation > Channel installation > **Manual installation**.
- 2** Press **▶** to enter the Manual installation menu. **System** is highlighted.
- 3** Press **▶** to enter the System list.
- 4** Press **▲** or **▼** to select your TV system: PAL BG, PAL I, PAL DK or NTSC M.
- 5** Press **◀** to return to the Manual installation menu.

Channel install...	Manual installation
Automatic install...	System
Manual installation	Search
Rearrange	Fine tune
	Store current ch...
	Store as new ch...

6.2.2 Search for and store a new channel

- 1** Press **Menu** on the remote control and select TV menu > Installation > Channel installation > Manual installation > **Search**.
- 2** Press **▶** to enter the Search menu.
- 3** Press the red key to enter the frequency yourself or press the green key to search for a next channel.

Tip

If you know the frequency, enter the three numbers of the frequency with the number keys of the remote control.

- 4** Press **◀** when the new channel has been found.
- 5** Select **Store as new channel** to store the new channel under a new channel number.

- 6 Press **▶** to enter.
- 7 Press **OK**.
Done appears.
- 8 Press **Menu** to quit the channel installation menu.

6.2.3 Fine tune a channel

Fine tune a found channel when the reception is poor:

- 1 Press **Menu** on the remote control and select TV menu > Installation > Channel installation > Analogue: manual installation > **Fine tune**.
- 2 Press **▶** to enter the Fine tune menu.
- 3 Press **▲** or **▼** to adjust the frequency
- 4 Press **◀** when you finished fine tuning.
- 5 Select **Store current channel** to store the fine tuned channel under the current channel number.
- 6 Press **▶** to enter.
- 7 Press **OK**.
Done appears.
- 8 Press **Menu** to quit the Channel installation menu.

6.3 Rearrange stored channels

To rename, reorder, uninstall or reinstall stored channels.

6.3.1 Rename a channel

Assign or change a channel name to a channel for which a name has not yet been entered.

- 1 Press **Menu** on the remote control and select TV menu > Installation > Channel installation > **Rearrange**.
- 2 Press **▶** to enter the channel list.
- 3 Press **▲** or **▼** in the channel list to select the channel you want to rename.
- 4 Press the red key.
- 5 Press **◀** or **▶** to select a character or **▲** or **▼** to change the characters. Space, numbers and other special characters are located between **z** and **A**.
- 6 Press the green key or **OK** to finish.

Tip

With the yellow key all characters can be deleted. With the blue key you can delete the character which is highlighted.

6.3.2 Uninstall or reinstall a channel

To uninstall a stored channel so that it is no longer possible to tune to.

Reinstall an earlier uninstalled channel.

- 1 Press **Menu** on the remote control and select TV menu > Installation > Channel installation > **Rearrange**.
- 2 Press **▶** to enter the channel list.
- 3 Press **▲** or **▼** in the channel list to select the channel you want to uninstall or reinstall.
- 4 Press the green key to uninstall or reinstall the channel.
- 5 Press **Menu** to quit the menu.

6.3.3 Reorder the channels

Change the order of the stored channels.

- 1 Press **Menu** on the remote control and select TV menu > Installation > Channel installation > **Rearrange**.
- 2 Press **▶** to enter the channel list.
- 3 Press **▲** or **▼** in the channel list to select the channel you want to reorder.
- 4 Press the yellow key to move up the highlighted channel in your channel list.
- 5 Press the blue key to move down the highlighted channel in your channel list.
- 6 Press **Menu** to quit the menu.

6.4 Automatic channel management

Once a day, at 3 AM, all available TV channels are updated automatically. The update is done if your TV is in standby.

Earlier stored channels not found by the update will be removed from the channel list.

You can do this update yourself anytime.

- 1 Press **Menu** on the remote control and select TV menu > Installation > Channel installation > **Installation update**.
- 2 Press **▶** to enter the Installation update menu.
- 3 Press **OK**.
- 4 Press the green key to start.
The update starts and may take a few minutes.
- 5 When the update is completed, press the red key to return to the Channel installation menu.
- 6 Press **Menu** to quit the menu.



6.5 Factory settings

If you are lost in the picture, sound and Ambilight settings, you can reset the TV to the factory settings of picture, sound and Ambilight

- 1** Press **Menu** on the remote control and select TV menu > Installation > **Factory settings**.
- 2** Press **▶** to enter the Factory settings menu.
- 3** Press **OK**.
- 4** Press **Menu** to quit the menu.

Note

The channel installation settings are not changed.

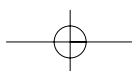
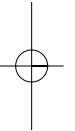
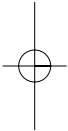

7 Connections

7.1 Connection overview

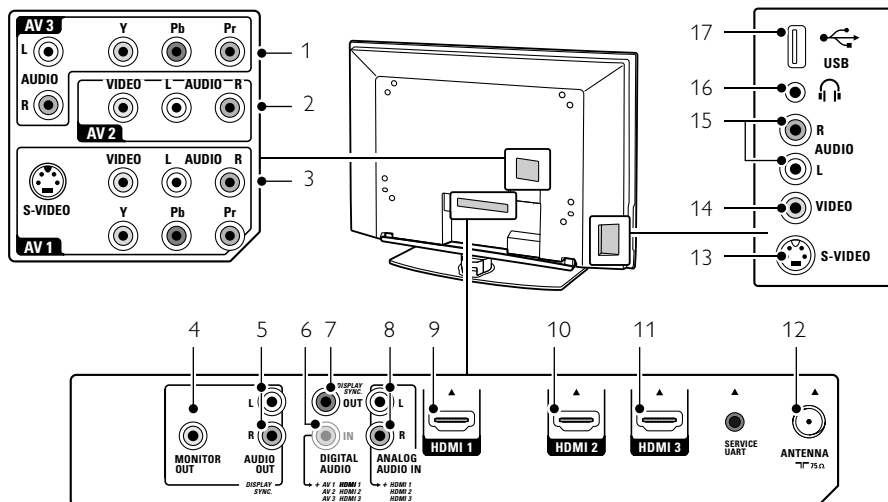

Back connectors

- 1 **AV3**
Component Video Y Pb Pr and Audio L/R connectors for DVD, digital receiver or game console, etc.
- 2 **AV2**
Second AV connector.
- 3 **AV1**
AV connector for DVD, VCR, digital receiver, game console, etc.
- 4 **Monitor Out**
Output connector for daisy chaining or to record programmes from your TV.
- 5 **Audio Out L/R**
Sound output cinch connectors for a Home Theatre System, etc.
- 6 **Digital Audio In** (if present)
Sound input cinch connector for use with any of the HDMI connectors with a HDMI to DVI adaptor.
- 7 **Digital Audio Out**
Sound output cinch connector for a Home Theatre System, etc.
- 8 **Analogue Audio In**
Sound input cinch connectors for use with any of the HDMI connectors with a HDMI to DVI adaptor.

- 9 **HDMI 1 In**
HDMI in connector for Blu-ray Disc player, HD digital receiver or HD game console, etc.
- 10 **HDMI 2 In**
Second HDMI in connector.
- 11 **HDMI 3 In**
Third HDMI in connector.
- 12 **Antenna input**

Side connectors

- 13 **S-Video**
S-Video input connector to be used together with Audio L/R connectors for camcorder, game console, etc.
- 14 **Video**
Video input cinch connector to be used together with Audio L/R connectors for camcorder, game console, etc.
- 15 **Audio L/R in**
Audio L/R for camcorder, game console, etc.
- 16 **Headphones**
Stereo Mini Jack.
- 17 **USB**
USB connector.

7.2 About connecting

Learn here how to make the best connection for your device.

Six connections are ready to use at the back of the TV - AV1, AV2, AV3, HDMI1, HDMI2 and HDMI3. Connect your device with the highest possible quality connection. Look for the highest quality connection on your device. Use that connection to your TV.

Connection set up

When connecting is done the TV needs to know what connections you made, which device is connected to which connector. Use the TV menu to do this. See section **7.4 Connection set up**.

7.2.1 HDMI - Highest quality ★★★★★

A HDMI connection has the best picture and sound quality. One cable combines video and audio signals. Use HDMI for HD (High Definition) TV signals. A device connected with HDMI to the TV can only send out audio and video signals to your TV. The device cannot receive or record audio and video from your TV.

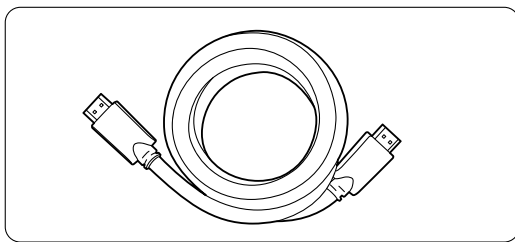

HDMI cable (max. 5m)

Tip

Use a HDMI / DVI adaptor in case your device has only a DVI connection. An extra audio cable is needed to complete this connection.

Note

HDMI supports HDCP (High-bandwidth Digital Contents Protection). HDCP is a copy protection signal that comes with HD content (DVD disc or Blu-ray Disc).

7.2.2 HDMI-control (if present)

HDMI with Consumer Electronics Control (CEC) adds to the normal HDMI advantages. It offers easy operation of the TV and connected devices. These devices also have to be equipped with HDMI with CEC.

- 1 Press **Menu** on the remote control and select TV menu > Installation > **Preferences** and press navigation key right to enter the list.
- 2 Press navigation key up or down to select **HDMI-control**.
- 3 Press navigation key right to enter.
- 4 Select **On** to activate HDMI with CEC.

Note

HDMI-control might not work with other brands.

One touch play

Insert a DVD disc to watch and your TV will switch on from standby and show the DVD programme automatically when you start playing the disc.

- 1 Press **Play** ► on the device.
The TV is switched on from standby.

System standby

Switches off all devices with the TV remote control.

- 1 Press **Power** on the TV remote control for a few seconds.
All devices will switch to standby.

7.2.3 YPbPr - Higher quality ★★★★

Use the Component Video YPbPr connections together with the Audio L and R jack. Match the cable colours when you connect. YPbPr can handle HD TV signals.

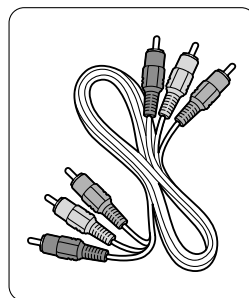

Component Video
YPbPr cable
- Red, Green, Blue

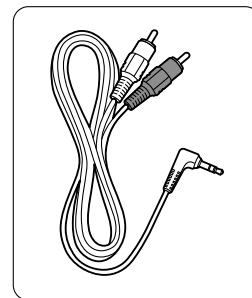

Audio L/R to
Red, White cable

7.2.4 S-Video - Good quality ★★

Use a S-Video cable together with an Audio L/R (cinch) cable. Match the cable colours when you connect.

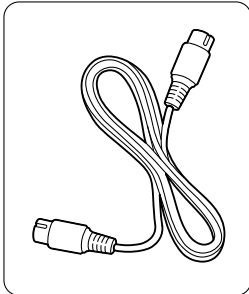

An S-Video cable

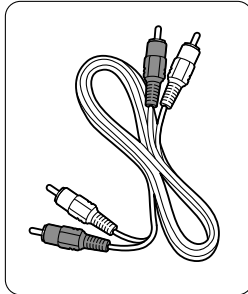
Audio L/R cable
- Red, White**7.2.5 Video** - Basic quality ★

Use a Video (cinch) cable together with an Audio L/R (cinch) cable. Match the cable colours when you connect.

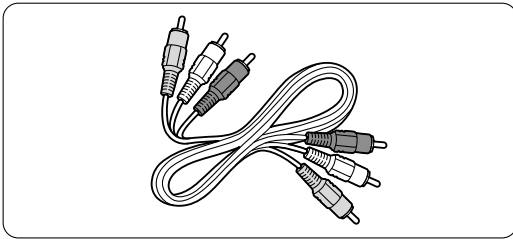
Combined Video - yellow and Audio L/R cable
- red and white**7.2.6 Display synchronised audio out**

For the best match of image and sound in speech on screen, connect a Home Theatre System to Audio L/R or Digital Audio outputs.

See diagrams **7.3.4** and **7.3.8**.

Do not connect the audio signal of a DVD player, digital receiver or other audio/video device directly to the Home Theatre System.

7.3 Connect your devices

The connections shown in this section are recommendations for the most used cases. Other solutions may be possible.

7.3.1 DVD player

Use a YPbPr cable and an audio L and R (cinch) cable to connect the device to the AV1 or AV3 input at the back of the TV.

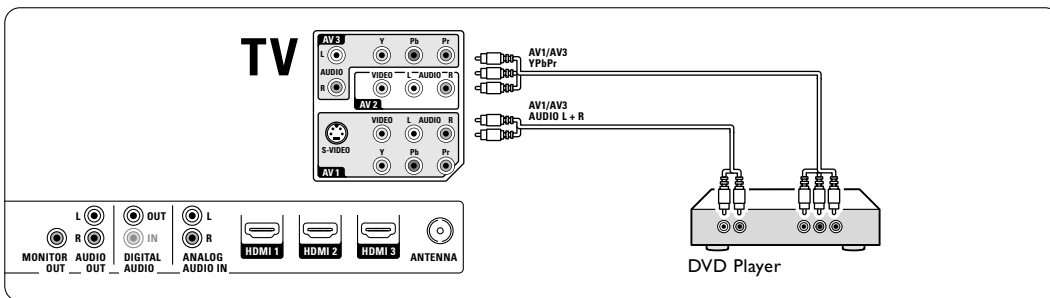

7.3.2 DVD Recorder or Digital Receiver

Use a YPbPr cable and an audio L and R (cinch) cable and 2 antenna cables.

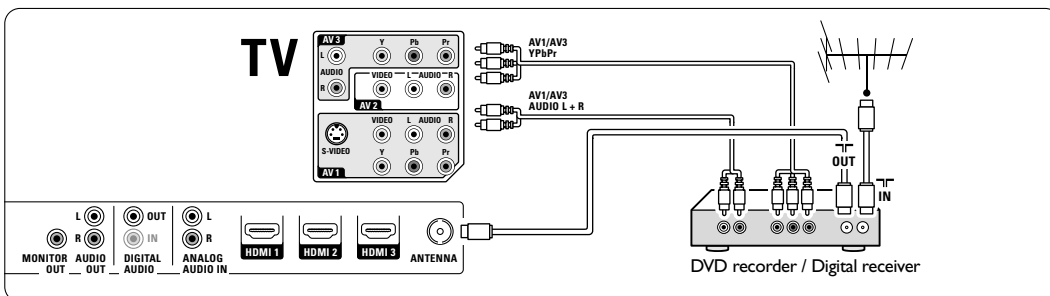

7.3.3 DVD Recorder and Digital Receiver

Use 3 YPbPr cables and 2 audio L and R (cinch) cables and 3 antenna cables.

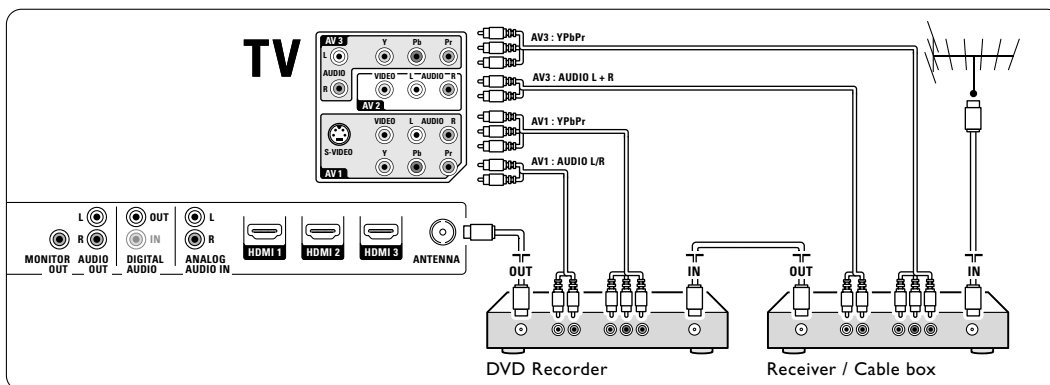

7.3.4 DVD Recorder and Home Theatre System

Use a YPbPr cable and an audio L and R (cinch) cable, 2 antenna cables and 1 digital audio (cinch) cable.

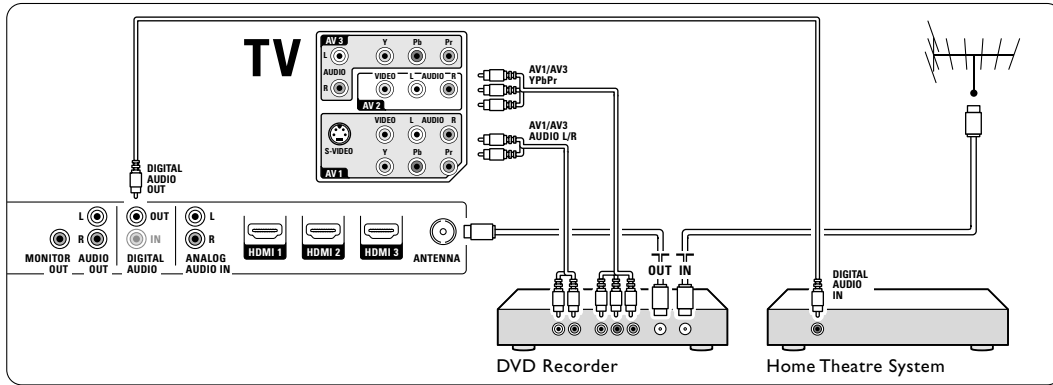

7.3.5 DVD Recorder and DVD Home Theatre System

Use 2 YPbPr cables and 2 audio L and R (cinch) cables, 2 antenna cables and 1 digital audio (cinch) cable.

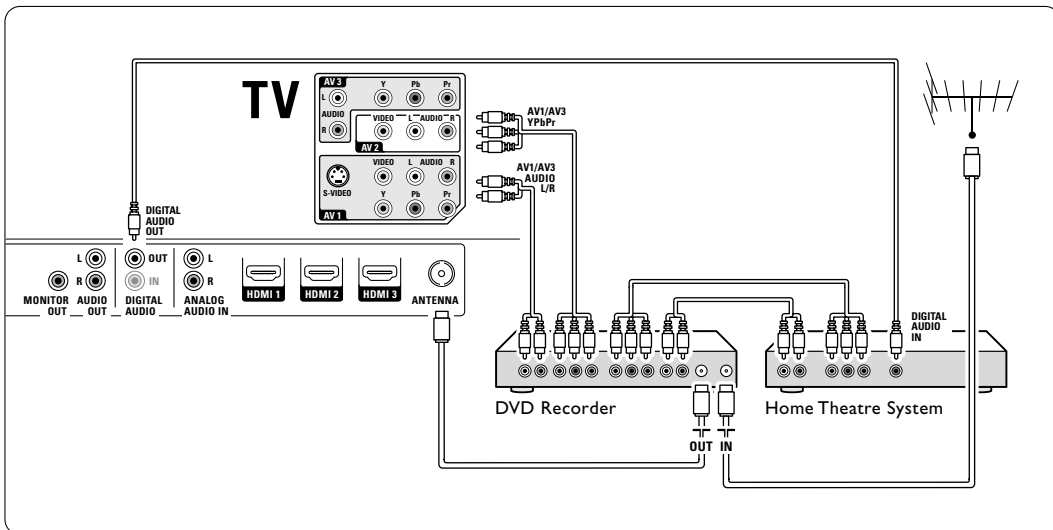

7.3.6 Satellite receiver

Use a YPbPr cable and audio L and R (cinch) cable and 2 antenna cables.

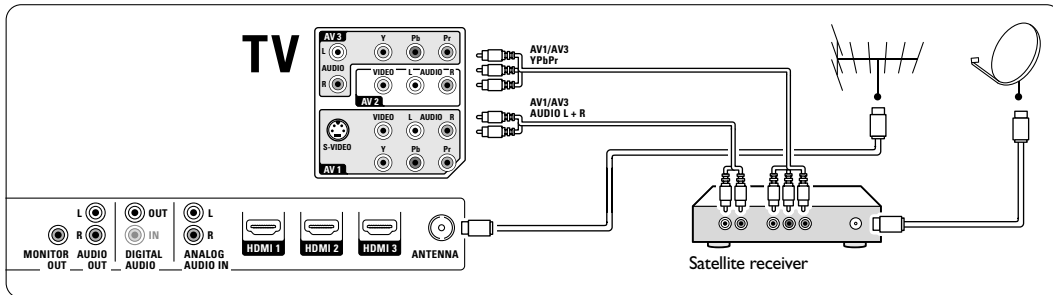

7.3.7 HD Digital receiver / HD satellite receiver

Use a HDMI cable and 2 antenna cables.

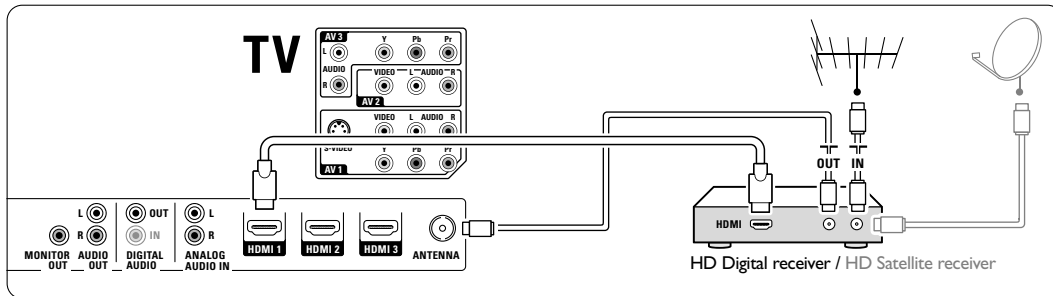

7.3.8 DVD-R, Home Theatre System and Digital receiver

Use 3 YPbPr cables and 3 audio L and R (cinch) cables, 3 antenna cables and 1 digital audio (cinch) cable.

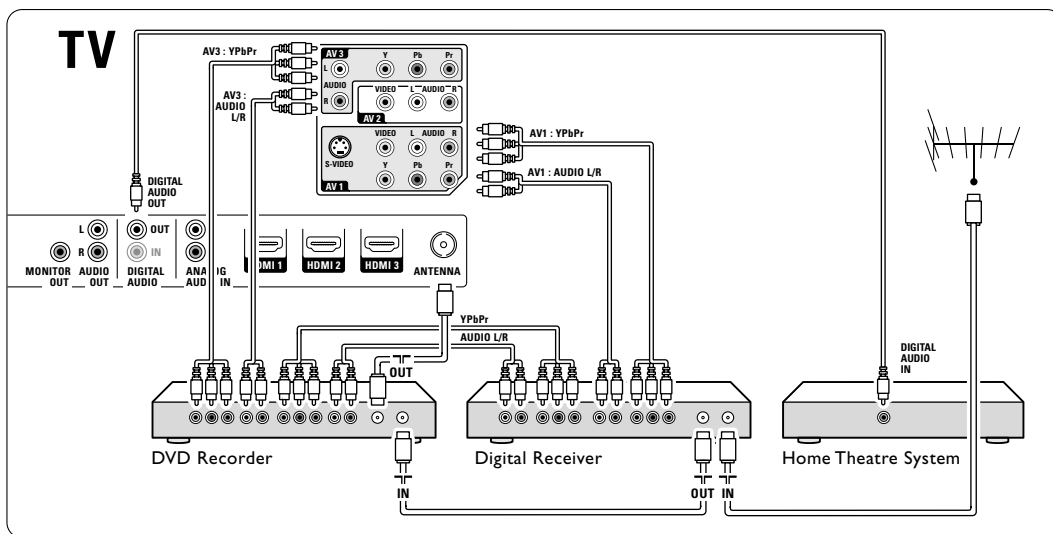

7.3.9 Blu-ray Disc player

Use a HDMI cable.

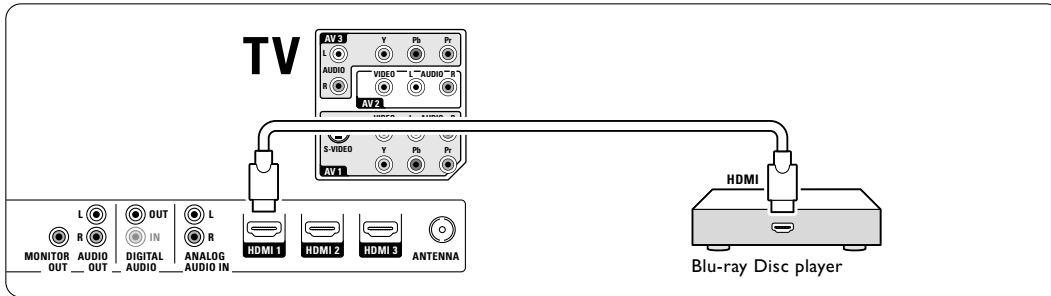

7.3.10 Game console

The most practical connection for a game console is at the side of the TV. More qualitative connections are at the back of the TV.

Connected at the side of the TV

Use the Video and Audio L/R (cinch) connectors.

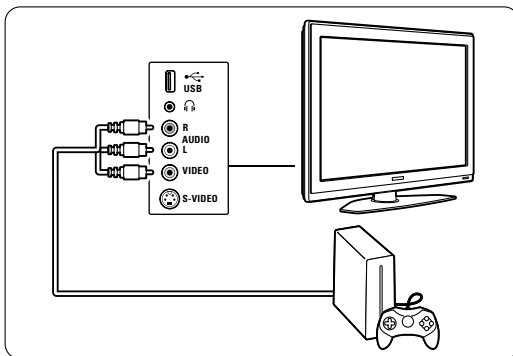

Connected at the back of the TV

Use a HDMI or the YPbPr (AV1 or AV3) input for HD quality.

7.3.11 Camcorder

The most practical connection for a camcorder is at the side of the TV. More qualitative connections are at the back of the TV.

Connected at the side of the TV

Use the Video and Audio L/R (cinch) connectors or use the S-Video and Audio L/R connectors.

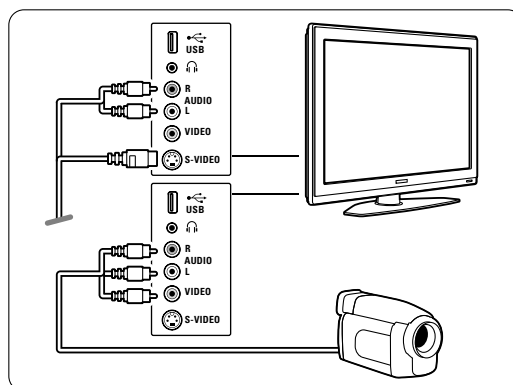

Connected at the back of the TV

Use a HDMI or the YPbPr (AV1 or AV3) input for HD quality.

7.3.12 Personal Computer

The best connection for a PC is at the back of the TV. A more practical connection, but only for viewing photos and films from your PC, is the connection at the side of the TV.

⚠ Caution

Before connecting the PC, set the PC monitor refresh rate to 60Hz.

Connected at the back of the TV

Use the DVI connection of your PC to connect to a HDMI connection of the TV. Use a HDMI to DVI cable or a HDMI-to-DVI-adaptor. Add an Audio L and R cable and connect it to Audio L and R jacks of **ANALOG AUDIO IN** on the TV.

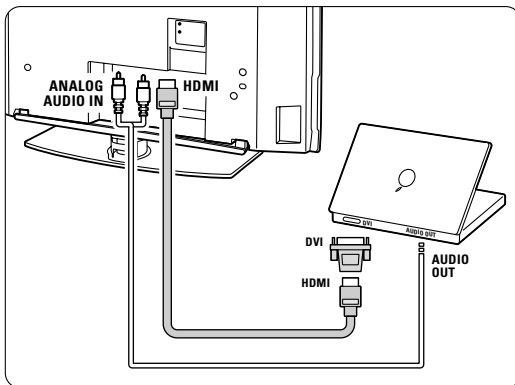

In the Connections menu, link this **AUDIO IN L/R** to the HDMI connector you are using. See section **7.4 Connections setup**.

Connected at the side of the TV

If your PC has no DVI connection, use the S-Video and Audio L/R (cinch) connectors at the side of the TV. This connection is only suited for applications like Windows Media Center or similar.

⚡ Tip

Change the TV picture format to **Unscaled** in the Picture format menu for maximal picture sharpness. See section **5.3.4. Widescreen picture format**.

For supported PC monitor resolutions, see section **8 Technical data**.

7.4 Connections setup

When all devices have been connected the TV needs to know what connections you have made, which device is connected to which connector.

7.4.1 Digital Audio In (if present)

If you use the Digital Audio In connection, assign this connection, in the menu, to the device from where the sound comes from.

- 1** Press **Menu** on the remote control and select TV menu > Installation > Connections > **Digital Audio In**.
- 2** Press **▶** to enter the list.
- 3** Press **▼** or **▲** to select the connector used by the device.

Connections	DIGITAL AUDIO IN
...	None
AV 3	AV 1
HDMI 1	AV 2
HDMI 2	AV 3
HDMI 3	HDMI 1
Side	HDMI 2
AUDIO IN L/R	HDMI 3
DIGITAL AUDIO IN	Side

7.4.2 Audio In L/R

If you use the Audio In L/R connection, assign this connection, in the menu, to the device from where the sound comes from.

- 1** Press **Menu** on the remote control and select TV menu > Installation > Connections > **Audio In L/R**.
- 2** Press **▶** to enter the list.
- 3** Press **▼** or **▲** to select the connector used by the device.

Connections	AUDIO IN L/R
...	None
AV 3	AV 3
HDMI 1	HDMI 1
HDMI 2	HDMI 2
HDMI 3	HDMI 3
Side	
AUDIO IN L/R	

7.4.3 Naming your devices

Name the connected devices for easy selection and best signal handling.

Assign the type of device (DVD, VCR, Game ...) to the connector you use for that device.

- 1** Press **Menu** on the remote control and select TV menu > Installation > Connections > **AV1**.
- 2** Press **▶** to enter the list.
- 3** Press **▼** or **▲** to select the type of device.
- 4** Press **Menu** to quit the menu.

Connections	AV 1
AV 1	None
AV 2	DVD
AV 3	Blu-ray
HDMI 1	HDD/DVDR
HDMI 2	HD rec.
HDMI 3	Game
Side	VCR
...	...

8 Technical data

Picture / Display

- Display type: LCD Full HD W-UXGA
- Panel resolution: 1920x1080p
- Perfect Pixel HD picture enhancement
- 1080p 24/25/30/50/60Hz processing

Supported display resolutions

- Computer formats

Resolution	Refresh rate
640 × 480	60Hz
800 × 600	60Hz
1024 × 768	60Hz
1280 × 768	60Hz
1360 × 768	60Hz
1920 × 1080i	60Hz
1920 × 1080p	60Hz
- Video formats

Resolution	Refresh rate
480i	60Hz
480p	60Hz
576i	50Hz
576p	50Hz
720p	50Hz, 60Hz
1080i	50Hz, 60Hz
1080p	24Hz, 25Hz, 30Hz
1080p	50Hz, 60Hz

Tuner / Reception / Transmission

- Antenna input: 75ohm coaxial (IEC75)
- TV system: DVD COFDM 2K/8K
- Video playback: PAL BG; PAL I, PAL DK, NTSC M
- DVD

Dimensions and weights (approx.)

TV model	42PFL9532	47PFL9532
- width	1046mm	1157mm
- height	686mm	752mm
- depth	116mm	116mm
- weight	29kg	33kg
TV + stand		
- width	1046mm	1157mm
- height	748mm	820mm
- depth	264mm	305mm
- weight	36kg	42kg

Sound

- Sound system:
 - Virtual Dolby Digital
 - BBE

Multimedia

- Connection: USB
- Playback formats: MP3, LPCM, Slideshow (.alb) JPEG

Remote control

- Type: RC4450
- Batteries: 2 Size AA- R6 type

Connectivity

- AV1: Audio L/R, CVBS in, YPbPr, S-Video
- AV2: Audio L/R, CVBS in
- AV3: YPbPr, Audio L/R in
- HDMI 1
- HDMI 2
- HDMI 3
- HDMI-control 1.3a
- Analog Audio L/R out - display synchronised
- Analog Audio L/R in
- Digital Audio in (coaxial-cinch-S/PDIF) (if present)
- Digital Audio out (coaxial-cinch-S/PDIF) - display synchronised
- Monitor out
- Side: Audio L/R in, Video (CVBS) in, S-Video Headphone out (stereo mini jack), USB

Power

- Mains power: AC 220-240V (±10%)
- Power and standby power consumption: See technical specification on www.philips.com
- Ambient temperature: 5°C - 35°C

Specifications are subject to change without notice. For more specification details of this product see www.philips.com/support.

9 Troubleshooting

Television and remote control

The TV does not switch on

- Verify the mains cord connection.
- Verify if the batteries of the remote control are flat or weak. Verify their + / - orientation.
You can use the keys on the TV to switch the TV on.
- Unplug the mains cord, wait for one minute and plug in the mains again.

The TV does not react on the remote control

- Verify if the batteries of the remote control are not empty or weak. Verify their + / - orientation.
- Clean the remote control and TV sensor lens.
- Use the side control keys to change some of the basic settings of picture and sound.

1 Press **Volume -** and + to adjust the volume.

2 Press **Program/Channel -** and + to go through the channels marked as favourites.

3 Press **Menu** to show the main menu.
Press **Program/Channel -** and + to select and adjust picture and sound menu items.

The red light on the TV blinks

- Unplug the mains cord for half a minute and insert it again. Verify if there is enough space for ventilation. Wait until the TV has cooled down. When the TV does not restart to standby and the blinking occurs again, call our Customer Support Centre.

You forgot your code to unlock Child lock

- See section 5.8.3 **Set code / Change code**.

Wrong language in the TV menu ?

Follow these steps to change the language.

1 Press **Menu** on the remote control.

2 Press **▶**.

3 Use **▼** to highlight the third line.

4 Press **▶** three times.

5 Press **▼** or **▲** to select your language.

6 Press **OK**.

7 Press **Menu** to quit the menus.

TV channels

Some TV channels are gone

- Verify if the correct channel list is chosen.
- A channel could be uninstalled in the **Rearrange menu**.

Picture

There is no picture

- Verify if the antenna is connected properly.
- Verify if the correct device is selected.

The sound is on, but there is no picture

- Verify the contrast or brightness setting in the menu.

The TV picture is poor

- Verify if the antenna is connected properly.
- Loudspeakers, non-earthed audio devices, neon lights, high buildings or mountains can influence the picture quality. Try to improve the picture by changing the antenna direction or place devices away from the TV.
- Verify if the correct TV system is chosen in the Manual installation menu.
- If only a certain channel is poor, try to fine tune this channel in the **Fine tune** menu. See section 6.2.3.

The picture has poor colour

- Verify the colour settings in the Picture menu. Select any of the Reset to standard settings in the **Reset to standard** menu. See section 5.3.2.
- Verify the connections and cables of the connected devices.
- Verify if the correct colour system (Automatic, PAL, Secam, NTSC) has been selected in the TV menu > Installation > Preferences > Colour.

The TV did not remember my settings when I switch back on

- Verify if the TV is set to **Home** in the TV menu > Installation > Preferences > **Location** menu.

The picture does not fit the screen, it is too big or too small

- Select a more fitting picture format in the Picture format menu.
See section 5.3.4 **Widescreen picture format**.
- Name your connected device in the Connections menu to obtain the best signal handling.
See section 7.4.3 **Naming your devices**.

The picture position on screen is not correct

- Some picture signals from some devices do not fit the screen correctly. You can shift the picture with the **◀**, **▶** or **▲**, **▼** keys on the remote control. Check the signal output of the device.

Sound

There is a picture but no sound

- Verify the volume is not set to 0.
- Verify the sound has not been muted with the  key.
- Verify if all cables are connected properly.
- If no sound signal is detected, the TV automatically switches off the sound. This is proper operation and does not indicate malfunction.

The sound is poor

- Verify if the sound is set to Stereo.
- Verify the Equalizer settings.
- Select any of the Reset to standards settings in the **Reset to standard** menu. See section 5.3.2.

The sound comes from one speaker only

- Verify if the Balance is not set to extreme left or right.

HDMI connections

Trouble with devices connected with HDMI

- The HDMI - HDCP procedure might take a few seconds before the TV shows the picture from a device.
- If the TV does not recognise the device and the screen shows no picture, try switching from one device to another and back again to restart the HDCP procedure.
- If sound interruptions occur persistently, see the user manual of the device to verify the output settings. If that does not help, connect an additional audio cable.
- If an HDMI-to-DVI adaptor is used, verify if an additional audio connection is in place to complete the DVI connection.

USB connection

The TV does not show the USB device content

- Set your device (camera) to 'Mass Storage Class' compliant.
- The USB device may need specific driver software. Unfortunately this software can not be downloaded to your TV.

I can not see my files in the Multimedia menu.

- Not all audio and picture files are supported. See section 8 **Technical data**.

Audio and picture files do not playback smoothly

- The transfer performance of the USB device limits the transfer rate.

Personal computer

The PC display on my TV is not stable or is not synchronised

- Verify if the correct resolution mode is selected on your PC. See section 8 **Technical data**.

If your problem is not solved

Switch your TV off and on again. If the problem is not solved, call the Customer Support Centre or consult our website www.philips.com/support.

See the Customer Support Centre telephone numbers on the last page of this user manual.

Please, have the TV Model and Product Number ready before you call.

You can find these numbers on the packaging label or on the typelabel on the back and bottom of the TV.

Warning

Never try to repair the TV yourself.

10 Index

A

Active Control 14
Ambilight
 colour 16
 colour boost 16
 menu / settings 16
 modes 9
 with TV standby 16
Antenna
 cable 6
 connect 6
 with devices 28
Auto format 15
Automatic installation 24
Auto surround 16
Automatic Volume Leveler 16
AV1, AV2, AV3 30

B

Balance
 Ambilight 16
 sound 15
Batteries 3,6
Blacklevel 14
Blu-ray 28,29,33
Brightness 14
 ambilight 16

C

Cable
 HDMI 28
 YPbPr 28
 S-Video 29
 Video 29
Camcorder 33
Camera (photo) 33
Care of the screen 3
Change code 19
Channel
 all channels list 18
 favourite list 18
 installation 24
 lock 18
 management 25
 previous 10
 rearrange 25
 store / install 25

Child lock 19
Clock 13
Code 19
Colour enhancement 14
Colour
 menu 14
 keys 4,10
Connection
 best 28
 overview 27
 set up 30,35
Contrast 14
Custom lock 18
Custom tint 14

D

Delta volume 16
Device
 connecting 30
 naming 35
 watch 7
Digital
 audio out 27
 receiver 30
Dual I/II 16
Dual screen 10
DVD
 connect 30
 playback 7
 player 30
 recorder 30
Dynamic contrast 14

E

Equalizer 15

F

Factory settings 26
Favourite channel lists 18
Fine tune 25

G

Game console 33

H

HDCP 28
HDMI
 connection 28
HD digital receiver 32
HD natural motion 14
Headphone
 connect 4,27
 volume 16
Home
 location 41
Home theatre system 31
Hue 14

I

Installation
 automatic 24
 manual 24
 menu 24

K

Kensington Security Slot 5
Key(s)
 colour 10
 on TV 4
 on remote control 4,10

L

Language
 menu 24
Light sensor 14
Location 31
Locks 19

M

Mains cord 6
Manual installation 24
Menu key 11
Mono 16
Movie expand 15
MPEG artefact reduction 14
Music 21
Mute key 10

N

Naming devices 35
Noise reduction 14

O

OK key 10
On timer 18

P

Personal Computer
 connect 34
 display resolutions 36
Photo viewer 22
Picture
 format 14
 menu 14
Perfect Pixel HD 14
Position the TV 5
Power 7
Programme up/down 10

Q

Quick access menu 13

R

Rearrange channels 25
Recorder 30
Recycling 3
Remote control
 batteries 6
 overview 10
Rename 25
Reorder 25
Reset to standards 13

S

Safety 3
Satellite receiver 32
Screen cleaning 3
Search
 channels 24
 teletext pages 17
Set code 19
Settings assistant 13
Sharpness 14
Sleeptimer 18
Software update 22
Sound
 menu 15
 surround mode 16
Standby 18
Stationary images 3
Stereo 17
Subtitles 19
 shift 15
Super zoom 15
Switch on 7

T

Technical data 36
Teletext 17
 teletext 2.5 17
 dual screen 17
 menu 17
Teletext page 17
Timers 18
Tint 14
Troubleshooting 37
TV settings menu 13

U

USB
 connector 27
 device 20
 photo viewer 20

V

VCR
 connect 30
Video cable 29
Video formats 36
Volume
 key 10
 menu 15

W

Whitepoint 14
Widescreen picture format 15

Y

YPbPr 28