

请至以下互联网址注册产品以获得完整的信息服务  
[www.philips.com/welcome](http://www.philips.com/welcome)  
使用产品前请阅读用户手册并请保留备用!

飞利浦5000系列LED背光源液晶电视  
24PFF5595/T3

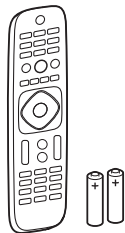

x4

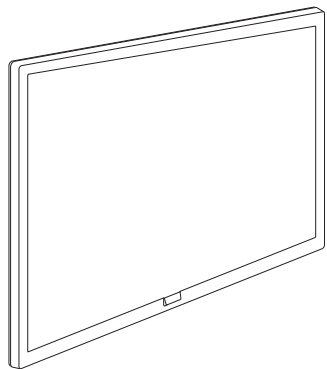
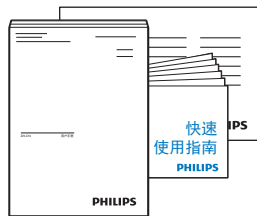
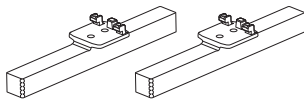

# 快速 使用指南

## PHILIPS

本手册所有示意图仅供参考，请以实际机型与实物为准!

# 您的产品包装箱内物品摆放位置

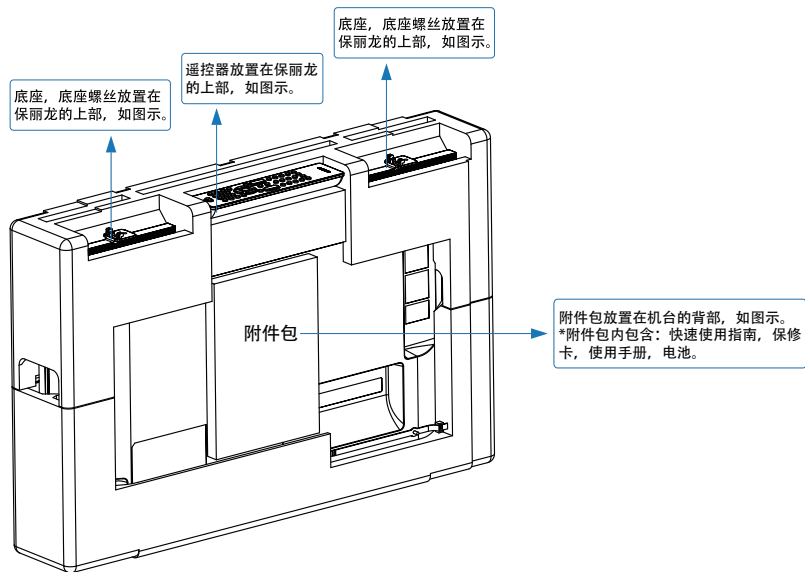

以上图示仅供参考，具体请以实际为准！

## 目录

您的产品包装箱内物品摆放位置	2
安装底座	4
连接	7
电池安装方式	10
打开电视	11

# 1

## 安装底座

### 1

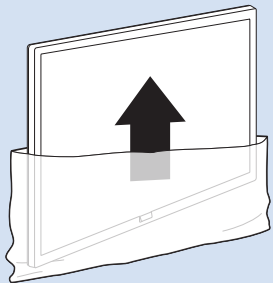

24" 2.77 kg



\*取出电视机。

### 2

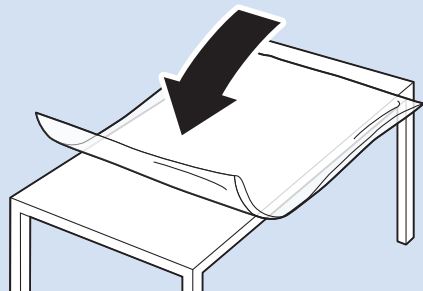

\*确保平整台面上无杂物后铺上软布。

### 3

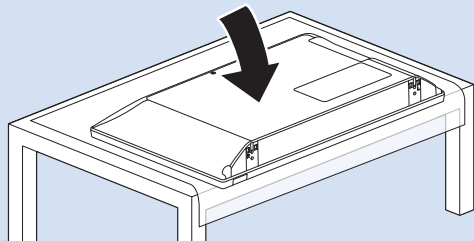

\*请将电视机底部边缘靠近台面边缘，将下巴放置于台面外约5cm。

### 4

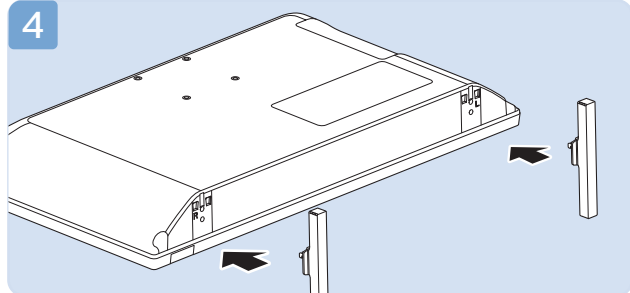

\*将底座按照图示对齐放置。

5

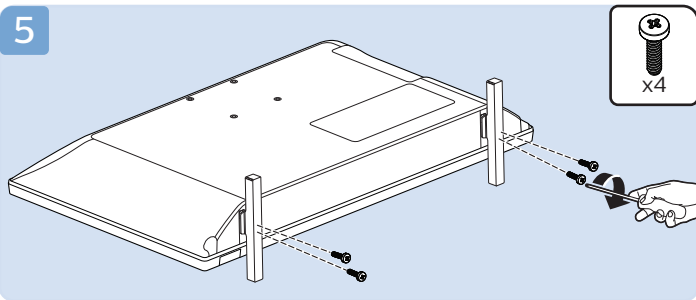

\*按照图示将螺丝锁紧。

6

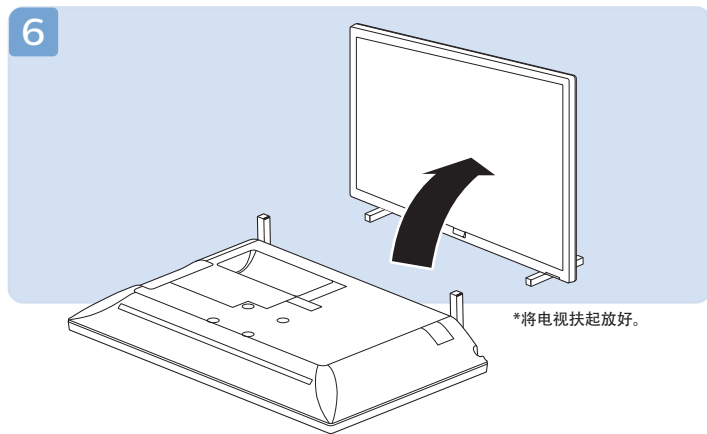

\*将电视扶起放好。

VESA (x,y)  
75x75 M4



(壁挂配件需另外购买)

建议螺丝有效螺牙长度10-12MM (不含壁挂架厚度)

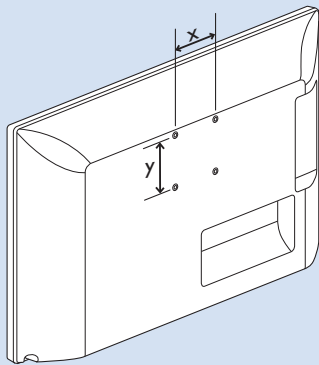

## 2

## 连接

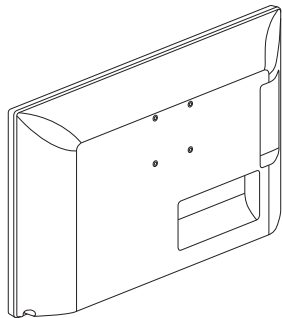

备注：由于用户装修时电源的地线与有线信号的地线电压有差异，可能造成有线信号与电视机连接处会有发热的情况，情况严重时会导致事故发生，为了避免安全事故的发生及提高观看电视的安全性，电视机内置集成天线隔离器。

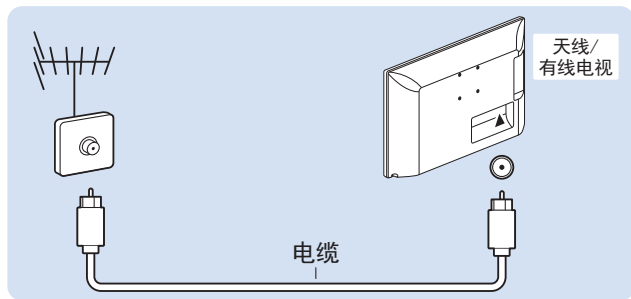
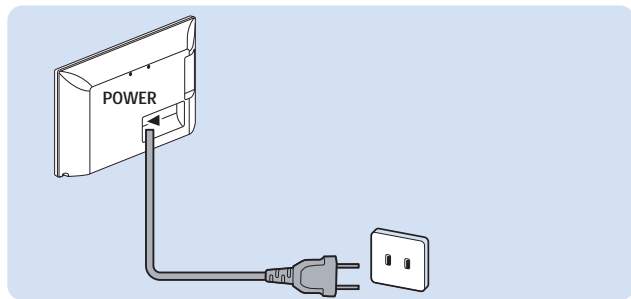

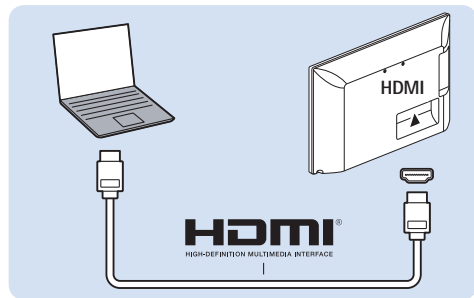
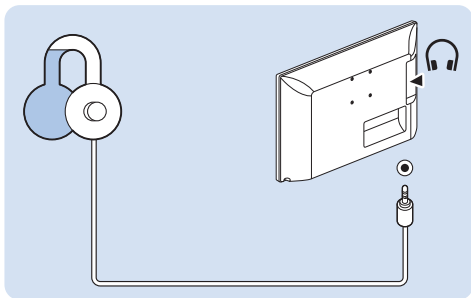
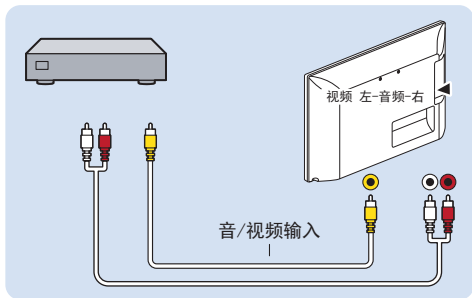
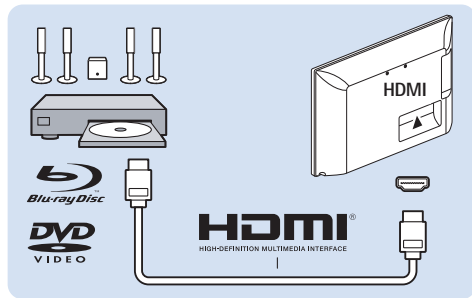
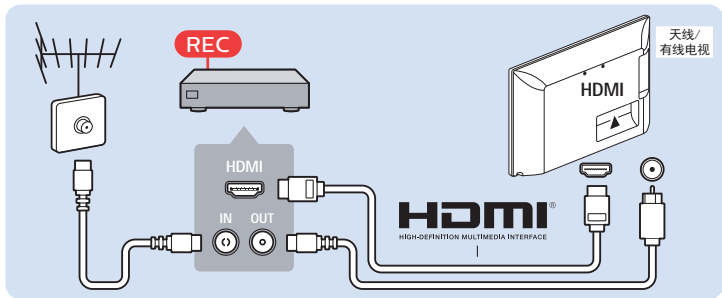



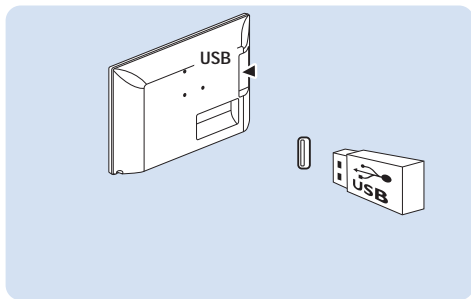
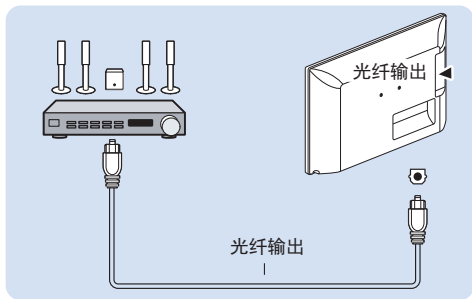

# 3



## 电池安装方式

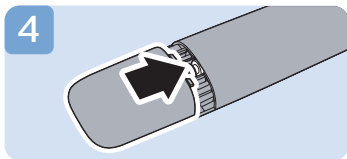
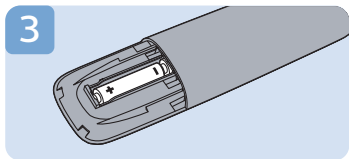
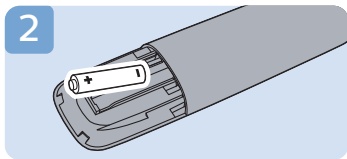
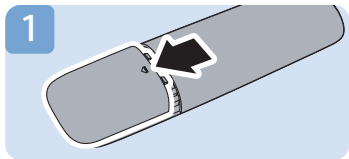

**温馨提示：**在长时间不使用遥控器的情况下，请将电池从遥控器的电池仓中取出，以避免电池电量损耗或遥控器损坏。

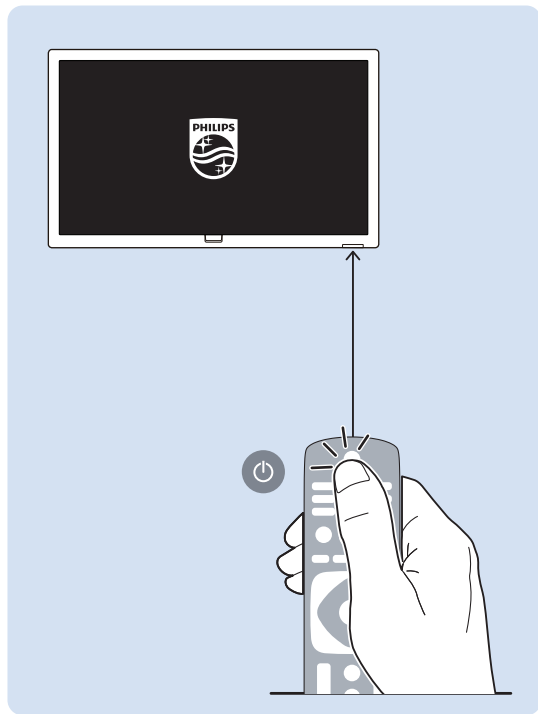

# 4

## 打开电视

按下电视侧面的电源开关，打开电视机。

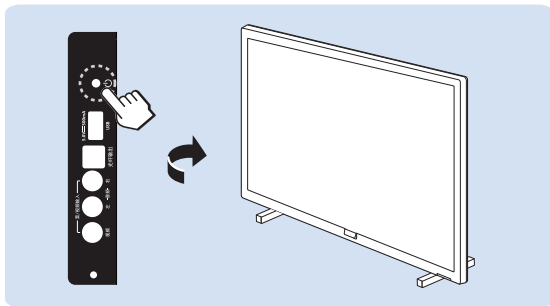

# 5

# ?

更多操作信息请参考使用手册与 PHILIPS support 网站。



马上扫码，报装报修，一步搞定，简单三步，加入飞利浦电视俱乐部，享额外延保专属权益！

扫码关注 · 飞你不可 · 注册会员

热线电话：4008 800 008

[www.philips.com.cn](http://www.philips.com.cn)





所有注册和未注册的商标是其各自所有者的财产。规格如有变更，恕不另行通知。  
Philips 和 Philips 盾牌图形是皇家飞利浦有限公司的注册商标，其使用需遵循皇家飞利浦有限公司的许可。

出版日期：2019年8月