

Register your product and get support at  
[www.philips.com/welcome](http://www.philips.com/welcome)

22PFL3415H/60

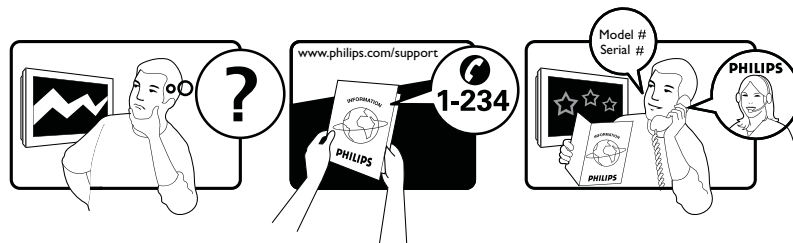

**PHILIPS**



Österreich	0810 000 205	€0.07 pro Minute
België/Belgique	078250145	€0.03 Per minuut/Par minute
България	+3592 489 99 96	Местен разговор
Hrvatska	01 6403 776	Lokalni poziv
Česká republika	800142840	Bezplatný hovor
Danmark	3525 8759	Lokalt opkald
Estonia	6008600	kohalik kõne tariifi
Suomi	09 2311 3415	paikallispuhelu
France	0805 025 510	numéro sans frais
Deutschland	0800 000 7520	gebührenfreier Anruf
Ελλάδα	0 0800 3122 1280	Κλήση χωρίς χρέωση
Magyarország	0680018189	Ingyenes hívás
Hrvatska	0800 222778	free
Ireland	North 0800 055 6882 South 1800-PHILIPS 7445477	free
Italia	800 088774	Numero Verde
Қазақстан	+7 727 250 66 17	local
Latvia	52737691	local
Lithuania	67228896	local
Luxemburg/Luxembourg	40 6661 5644	Ortsgespräch/Appel local
Nederland	0800 0230076	Gratis nummer
Norge	22 70 81 11	Lokalsamtale
Polska	(022) 349-15-05	Monitory i akcesoria komputerowe,
Portugal	800 780 903	Chamada Grátis
România	0800-894910 0318107125	Apel gratuit Apel local
Россия	(495) 961-1111	0.15 USD/minute
Србија	+381 114 440 841	Lokalni poziv
Slovensko	0800 004537	Bezplatný hovor
Slovenija	00386 12 80 95 00	lokalni klic
España	900 800 655	Teléfono local gratuito solamente para clientes en España
Sverige	08 5792 9100	Lokalsamtal
Suisse/Schweiz/Svizzera	0844 800 544	Schweizer Festnetztarif
Türkiye	0800 261 3302	Şehirçi arama
United Kingdom	General No: 0800 331 6015 General National Rate No: 0870 911 0036	free National rate
Україна	8-800-500-69-70	Місцевий виклик

# Contents

<b>1 Notice</b>	2	<b>6 Install channels</b>	27
		Automatically install channels	27
<b>2 Important</b>	4	Manually install channels	28
		Rename channels	29
<b>3 Your TV</b>	7	Rearrange channels	29
Side controls and indicators	7	Test digital reception	30
Remote control	7		
<b>4 Use your TV</b>	9	<b>7 Connect devices</b>	31
Switch your TV on / off or to standby	9	Back connector	31
Switch channels	9	Side connector	32
Watch connected devices	10	Connect a computer	34
Adjust TV volume	10	Use a Conditional Access Module	35
Use teletext	10	Use Philips EasyLink	36
		Use a Kensington lock	37
<b>5 Use more of your TV</b>	11	<b>8 Product information</b>	38
Access TV menus	11	Supported display resolutions	38
Rename devices from the home menu	11	Multimedia	38
Remove devices from the home menu	11	Tuner / Reception / Transmission	38
Change picture and sound settings	12	Remote control	38
Use the universal access menu	15	Power	38
Use advanced teletext features	15	Supported TV mounts	39
Create and use list of favourite channels	16	Product specification	39
Use the Electronic Programme Guide	17		
Use the TV clock	18	<b>9 Troubleshooting</b>	40
Use timers	19	General TV issues	40
Use TV locks	20	TV channel issues	40
Use subtitles	21	Picture issues	40
View photos and play music from a USB storage device	22	Sound issues	41
Listen to digital radio channels	24	HDMI connection issues	41
Update the TV software	24	Computer connection issues	41
Change TV preferences	25	Contact us	41
Access decoder channel	26		
Start a TV demo	26	<b>10 Index</b>	42
Reset the TV to factory settings	26		

# 1 Notice

2010 © Koninklijke Philips Electronics N.V. All rights reserved.

Specifications are subject to change without notice. Trademarks are the property of Koninklijke Philips Electronics N.V. or their respective owners. Philips reserves the right to change products at any time without being obliged to adjust earlier supplies accordingly. The material in this manual is believed adequate for the intended use of the system. If the product, or its individual modules or procedures, are used for purposes other than those specified herein, confirmation of their validity and suitability must be obtained. Philips warrants that the material itself does not infringe any United States patents. No further warranty is expressed or implied.

## Warranty

- Risk of injury, damage to TV or void of warranty! Never attempt to repair the TV yourself.
- Use the TV and accessories only as intended by the manufacturer.
- The caution sign printed on the back of the TV indicates risk of electric shock. Never remove the TV cover. Always contact Philips Customer Support for service or repairs.



Any operation expressly prohibited in this manual, or any adjustments and assembly procedures not recommended or authorised in this manual shall void the warranty.

## Pixel characteristics

This LCD product has a high number of colour pixels. Although it has effective pixels of 99.999% or more, black dots or bright points of light (red, green or blue) may appear constantly on the screen. This is a structural property of the display (within common industry standards) and is not a malfunction.

## Compliance with EMF

Koninklijke Philips Electronics N.V. manufactures and sells many products targeted at consumers which, like any electronic apparatus, in general have the ability to emit and receive electromagnetic signals.

One of Philips' leading Business Principles is to take all necessary health and safety measures for our products, to comply with all applicable legal requirements and to stay well within the EMF standards applicable at the time of producing the products.

Philips is committed to develop, produce and market products that cause no adverse health effects. Philips confirms that if its products are handled properly for their intended use, they are safe to use according to scientific evidence available today.

Philips plays an active role in the development of international EMF and safety standards, enabling Philips to anticipate further developments in standardisation for early integration in its products.

### Mains fuse (UK only)

This TV is fitted with an approved moulded plug. Should it become necessary to replace the mains fuse, this must be replaced with a fuse of the same value as indicated on the plug (example 10A).

- 1 Remove fuse cover and fuse.
- 2 The replacement fuse must comply with BS 1362 and have the ASTA approval mark. If the fuse is lost, contact your dealer in order to verify the correct type.
- 3 Refit the fuse cover.

In order to maintain conformity to the EMC directive, the mains plug on this product must not be detached from the mains cord cable.

### Copyright

® Kensington and Micro Saver are registered US trademarks of ACCO World corporation with issued registrations and pending applications in other countries throughout the world.



Manufactured under license from Dolby Laboratories. Dolby and the double-D symbol are trademarks of Dolby Laboratories.

### Note

- Available in selected models only.



HDMI, the HDMI logo and High-Definition Multimedia Interface are trademarks or registered trademarks of HDMI Licensing LLC. All other registered and unregistered trademarks are the property of their respective owners.

# 2 Important

Read and understand all instructions before you use your TV. If damage is caused by failure to follow instructions, the warranty does not apply.

---

## Safety

### Risk of electric shock or fire!

- Never expose the TV to rain or water. Never place liquid containers, such as vases, near the TV. If liquids are spilt on or into the TV, disconnect the TV from the power outlet immediately. Contact Philips Consumer Care to have the TV checked before use.
- Never place the TV, remote control or batteries near naked flames or other heat sources, including direct sunlight. To prevent the spread of fire, keep candles or other flames away from the TV, remote control and batteries at all times.



- Never insert objects into the ventilation slots or other openings on the TV.
- When the TV is swivelled ensure that no strain is exerted on the power cord. Strain on the power cord can loosen connections and cause arcing.

### Risk of short circuit or fire!

- Never expose the remote control or batteries to rain, water or excessive heat.
- Avoid force coming onto power plugs. Loose power plugs can cause arcing or fire.

### Risk of injury or damage to the TV!

- Two people are required to lift and carry a TV that weighs more than 25 kg.
- When stand mounting the TV, use only the supplied stand. Secure the stand to the TV tightly. Place the TV on a flat, level surface that can support the combined weight of the TV and the stand.
- When wall mounting the TV, use only a wall mount that can support the weight of the TV. Secure the wall mount to a wall that can support the combined weight of the TV and wall mount. Koninklijke Philips Electronics N.V. bears no responsibility for improper wall mounting that result in accident, injury or damage.

### Risk of injury to children!

Follow these precautions to prevent the TV from toppling over and causing injury to children:

- Never place the TV on a surface covered by a cloth or other material that can be pulled away.
- Ensure that no part of the TV hangs over the edge of the surface.
- Never place the TV on tall furniture (such as a bookcase) without anchoring both the furniture and TV to the wall or a suitable support.
- Educate children about the dangers of climbing on furniture to reach the TV.

### Risk of overheating!

- Never install the TV in a confined space. Always leave a space of at least 4 inches or 10 cm around the TV for ventilation. Ensure curtains or other objects never cover the ventilation slots on the TV.

### Risk of damage to the TV!

- Before you connect the TV to the power outlet, ensure that the power voltage matches the value printed on the back of the TV. Never connect the TV to the power outlet if the voltage is different.

**Risk of injury, fire or power cord damage!**

- Never place the TV or any objects on the power cord.
- To disconnect the TV power cord easily from the power outlet, ensure that you have full access to the power cord at all times.
- When you disconnect the power cord, always pull the plug, never the cable.
- Disconnect the TV from the power outlet and antenna before lightning storms. During lightning storms, never touch any part of the TV, power cord or antenna cable.

**Risk of hearing damage!**

- Avoid using earphones or headphones at high volumes or for prolonged periods of time.

**Low temperatures**

- If the TV is transported in temperatures below 5°C, unpack the TV and wait until the TV temperature matches room temperature before connecting the TV to the power outlet.

**Screen care**

- Avoid stationary images as much as possible. Stationary images are images that remain on-screen for extended periods of time. Examples include: on-screen menus, black bars and time displays. If you must use stationary images, reduce screen contrast and brightness to avoid screen damage.
- Unplug the TV before cleaning.
- Clean the TV and frame with a soft, damp cloth. Never use substances such as alcohol, chemicals or household cleaners on the TV.
- Risk of damage to the TV screen! Never touch, push, rub or strike the screen with any object.
- To avoid deformations and colour fading, wipe off water drops as soon as possible.

**Disposal of your old product and batteries**

Your product is designed and manufactured with high quality materials and components, which can be recycled and reused.



When this crossed-out wheeled bin symbol is attached to a product it means that the product is covered by the European Directive 2002/96/EC. Please inform yourself about the local separate collection system for electrical and electronic products.

Please act according to your local rules and do not dispose of your old products with your normal household waste.

Correct disposal of your old product helps to prevent potential negative consequences for the environment and human health.



Your product contains batteries covered by the European Directive 2006/66/EC, which cannot be disposed with normal household waste.

Please inform yourself about the local rules on separate collection of batteries because correct disposal helps to prevent negative consequences for the environmental and human health.

## Environmental efforts



- High energy efficiency
- Low standby power
- Designed to facilitate recycling

Philips continuously focuses on lowering the environmental impact of its innovative consumer products. We aim our efforts towards environmental improvements during manufacturing, reduction of harmful substances, energy-efficient use, end-of-life instructions and product recycling. Thanks to our environmental effort, this TV has been awarded the European Ecolabel –the flower– [www.ecolabel.eu](http://www.ecolabel.eu)

You can find detailed information on standby energy consumption, warranty policy, spare parts and recycling of this TV on the Philips website for your country at [www.philips.com](http://www.philips.com). This TV has features that contribute to energy-efficient use. This TV was awarded the European Ecolabel for its environmental qualities.

## Energy efficiency features

- **Energy saving**  
The energy saving setting of the TV combines several TV settings that result in saving energy. See the smart settings in the setup menu.
- **Low standby power consumption**  
The class-leading and highly advanced power circuitry brings down the power consumption of the TV to an extremely low level, without losing out on the constant standby functionality.

**Power management** (Available in selected models only)

The advanced power management of this TV ensures the most efficient use of its energy. You can check how your personal TV settings, the level of brightness in current onscreen pictures and the surrounding light conditions determine the relative power consumption.

### End of use

To inform yourself on the correct disposal of the TV and batteries, refer to 'Disposal of your old product and batteries' in the user manual (see 'Disposal of your old product and batteries' on page 5).



## 3 Your TV

Congratulations on your purchase, and welcome to Philips! To fully benefit from the support that Philips offers, register your TV at [www.philips.com/welcome](http://www.philips.com/welcome).

This section gives you an overview of commonly used TV controls and functions.

### Side controls and indicators

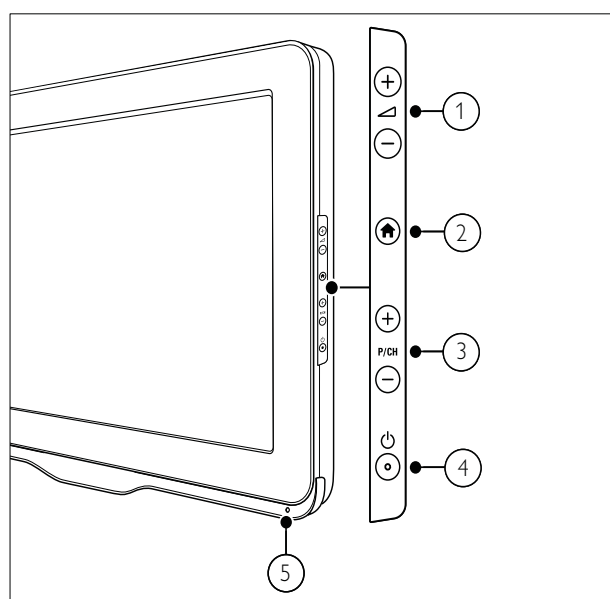

- ①  $\triangleleft$  +/-: Increases or decreases volume.
- ② **⬆** (Home): Toggles the home menu on or off.
- ③ P/CH +/-: Switches to the next or previous channel.
- ④ **⏻** (Power): Switches the product on or off. The product is not powered off completely unless it is physically unplugged.
- ⑤ Remote control sensor.

### Remote control

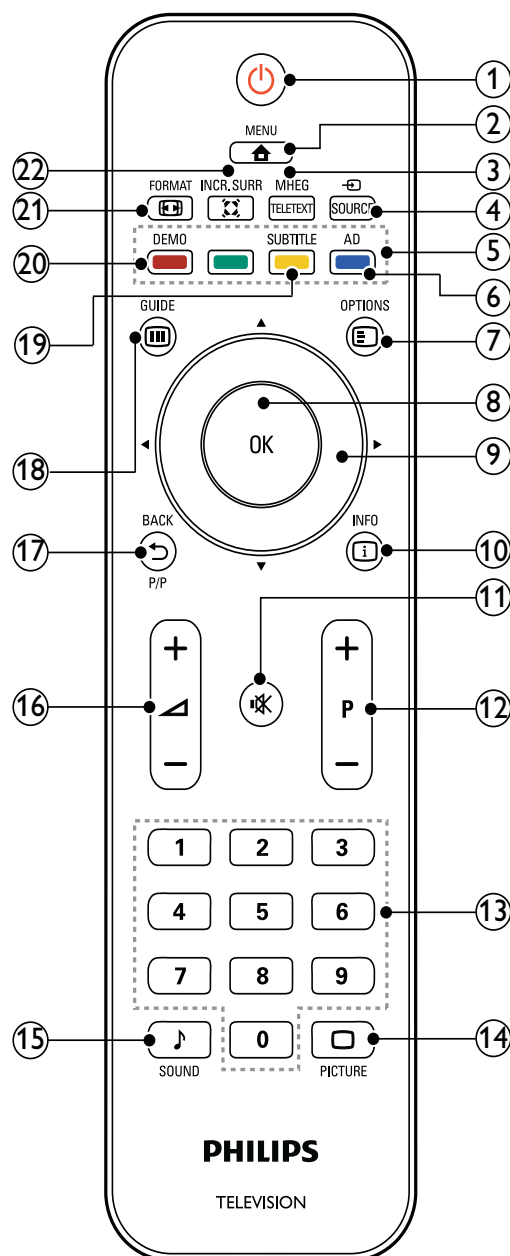

- ① **⏻** (Standby-On)
  - Switches the TV to standby if it is on.
  - Switches on the TV if it is in standby.
- ② **⬆** MENU  
Toggles the main menu on or off.
- ③ MHEG/TELETEXT  
Toggles teletext on or off.
- ④ **⏻** SOURCE  
Selects connected devices.

- ⑤ **Colour buttons**  
Selects tasks or options.
- ⑥ **AD (Audio Descriptor) (For RF Digital TV only)**  
UK only: Enables audio commentary for the visually handicapped.
- ⑦ **☰ OPTIONS**  
Accesses options relating to the current activity or selection.
- ⑧ **OK**  
Confirms an entry or selection and displays the channel grid, when watching TV.
- ⑨ **▲▼◀▶ (Navigation buttons)**  
Navigates menus.
- ⑩ **ℹ INFO**  
Displays program information, when available. If the information spans multiple pages, press **OPTIONS** to go to the next page.
- ⑪ **🔇 (Mute)**  
Mutes or restores volume.
- ⑫ **P +/- (Programme +/-)**  
Switches to the next or previous channel. When the TV menu is on, this functions as Page Up / Down.
- ⑬ **0-9 (Numeric buttons)**  
Selects a channel or setting.
- ⑭ **🖼 PICTURE (Smart picture)**  
Launches the picture menu.
- ⑮ **🎵 SOUND (Smart Sound)**  
Launches the sound menu.
- ⑯ **📶 +/- (Volume +/-)**  
Increases or decreases volume.
- ⑰ **⏪ BACK P/P (Previous channel)**
- Returns to a previous screen.
  - Returns to the previously viewed channel.
- ⑱ **📺 GUIDE**  
Switches between channel grid and programme list.
- ⑲ **SUBTITLE (For RF Digital TV only)**  
Enables or disables subtitles.
- ⑳ **DEMO (Used in selected models only)**  
Toggles the demonstration menu on or off.
- ㉑ **🖼 FORMAT**  
Selects a picture format.
- ㉒ **🔊 INCR. SURR**  
Enables Incredible Surround for stereo sources. Enables spatial mode for mono sources.

---

## Remote control usage

When using the remote control, hold it close to the TV and point it at the remote control sensor. Make sure that the line-of-sight between the remote control and TV is not blocked by furniture, walls or other objects.

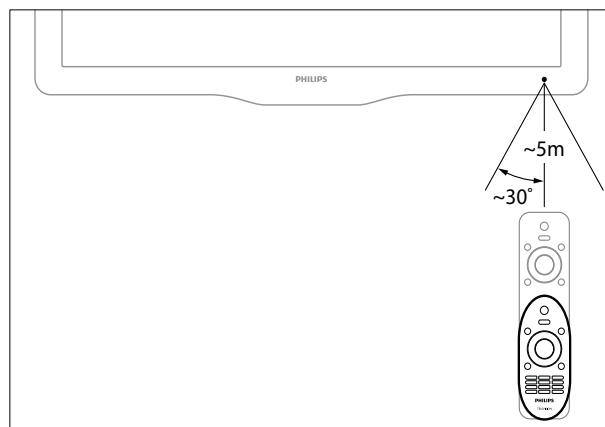



# 4 Use your TV

This section helps you perform basic TV operations.

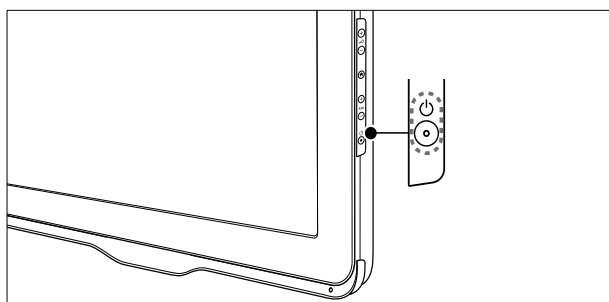
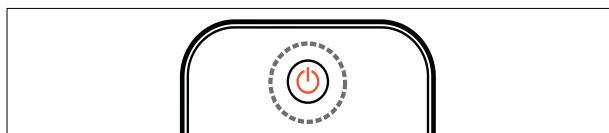
## Switch your TV on / off or to standby



### To switch on

- If the standby indicator is off, press  (**Power**) at the side of the TV.
- If the standby indicator is red, press  (**Standby-On**) on the remote control.

### To switch to standby

- Press  (**Standby-On**) on the remote control.  
↳ The standby indicator switches to red.

### To switch off

- Press  (**Power**) at the side of the TV.  
↳ The standby indicator switches off.



### Tip

- Though your TV consumes very little power when in standby, energy continues to be consumed. When not in use for an extended period of time, disconnect the TV power cable from the power outlet.



### Note

- If you cannot locate your remote control and want to switch on the TV from standby, press **P/CH +/-** on the side of the TV.

## Switch channels

- Press **P +/-** on the remote control or **P/CH +/-** on the side of the TV.
- Enter a channel number using the **Numeric buttons**.
- Press **OK** to use the channel grid.
- Press  **BACK P/P** on the remote control to return to the previous channel.







### Note

- When you use a favourite list, you can only select those channels in the list (see 'Select a favourite list' on page 16).

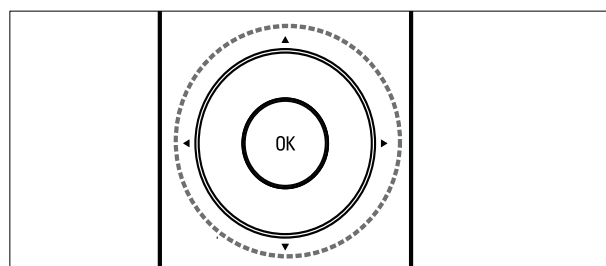
## Switch channels with the channel grid

The channel grid allows you to view all available channels in a grid format.



- 1 Press **OK**.  
↳ The channel grid appears.
- 2 Press     to browse the channel grid.
- 3 Press **OK** to select a channel.

## Watch connected devices

### Note

- Switch on the device before selecting it as a source on the TV.

## Use the source button

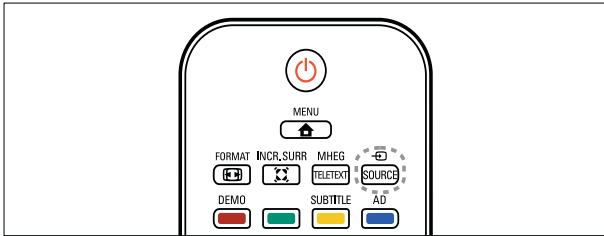

- 1 Press **SOURCE**.  
↳ The source list appears.
- 2 Press **▲▼** to select a device.
- 3 Press **OK** to confirm your choice.  
↳ The TV switches to the selected device.

## Adjust TV volume

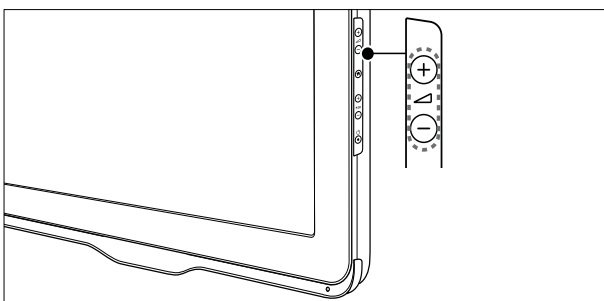
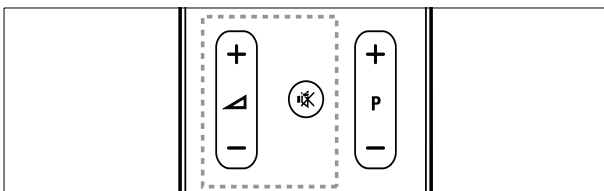

### To increase or decrease volume

- Press **▲▼**.

### To mute or unmute sound

- Press **🔇** to mute the sound.
- Press **🔇** again to restore the sound.

## Use teletext

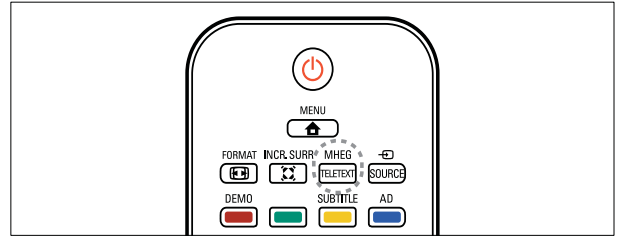

- 1 Press **MHEG/TELETEXT**.  
↳ The main index page appears.
- 2 Select a page as follows:
  - Press the **Numeric buttons** to enter a page number
  - Press **P +/-** to view the next or previous page
  - Press the **Colour buttons** to select a colour coded item
  - Press **↶ BACK** to return to a previously viewed page
- 3 Press **MHEG/TELETEXT** to exit teletext.

### Note

- For UK users only: Some digital TV channels offer dedicated digital text services (for example, BBC1).

# 5 Use more of your TV

## Access TV menus

Menus help you to install channels, change picture and sound settings and access other features.

- 1 Press **MENU**.  
↳ The menu screen appears.

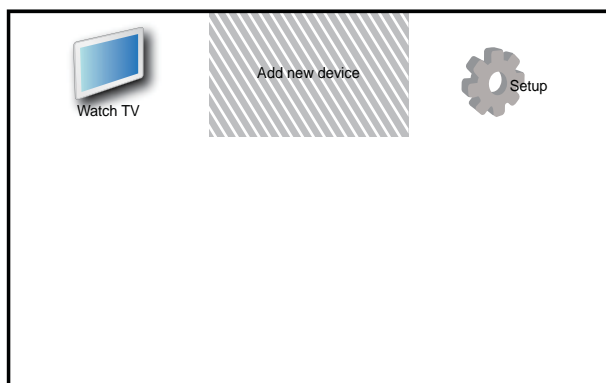

- 2 Press **▲▼◀▶** to select and navigate through one of the following menus.
  - **[Watch TV]**: Switches back to the aerial source if another source is selected.
  - **[Add new device]**: Adds new devices to the home menu.
  - **[Setup]**: Accesses menus to change picture, sound and other settings.
- 3 Press **OK** to confirm your choice.
- 4 Press **MENU** to exit.



### Tip

- After selecting **[Add new device]**, follow the on-screen instructions to select the correct device and connector.

## Rename devices from the home menu

After adding a new device to the home menu, you can rename it to your preference.

- 1 Press **MENU**.
- 2 Press **▲▼◀▶** to select a device to rename.
- 3 Press **OPTIONS**.  
↳ The options menu appears.
- 4 Press **▲▼** to select **[Rename device]**, then press **OK**.  
↳ A text input box appears.
- 5 Press **▲▼◀▶** to select characters.
- 6 Press **OK** to confirm each character.
- 7 Select **[Done]**, then press **OK** to finish renaming devices.



### Note

- The device name can be up to 16 characters long.
- Press **[Aa]** to change an uppercase letter to a lowercase letter and vice versa.

## Remove devices from the home menu

If a device is no longer connected to the TV, remove it from the home menu.

- 1 Press **MENU**.
- 2 Press **▲▼◀▶** to select a device to remove.
- 3 Press **OPTIONS**.
- 4 Press **▲▼** to select **[Remove device]**, then press **OK**.
- 5 Select **[Remove]**, then press **OK**.  
↳ The selected device is removed from the home menu.

---

# Change picture and sound settings

Change picture and sound settings to suit your preferences. You can apply pre-defined settings or change settings manually.

## Note

- When watching TV or using external devices, press **OPTION** then select **[Picture and sound]** for quick access to picture and sound settings.

---

## Use settings assistant

Use the settings assistant to guide you through the picture and sound settings.

- 1 Press **MENU**.
- 2 Press **▲▼◀▶** to select **[Setup] > [Picture] > [Settings assistant]**.
- 3 Press **OK**.
  - ↳ The **[Settings assistant]** menu appears. Follow the on-screen instructions to choose your preferred picture settings.

---

## Use smart picture

Use smart picture to apply pre-defined picture settings.

- 1 Press **PICTURE**.
  - ↳ The **[Smart picture]** menu appears.
- 2 Press **▲▼** to select one of the following settings.
  - **[Personal]**: Applies the settings set in **[Settings assistant]** menu.
  - **[Vivid]**: Applies rich and dynamic settings.
  - **[Standard]**: Adjusts picture settings to suit most environments and types of video.
  - **[Cinema]**: Applies settings for movie viewing.
  - **[Game]**: Applies settings for games.

- **[Energy saving]**: Applies low-energy settings.
- **[Natural]**: Applies the best picture quality.
- **[Custom]**: Lists customised picture settings.

- 3 Press **OK** to confirm your choice.
  - ↳ The selected smart picture setting is applied.

---

## Manually adjust picture settings

- 1 Press **MENU**.
- 2 Press **▲▼◀▶** to select **[Setup] > [Picture]**.
- 3 Press **▲▼◀▶** to select the following settings.
  - **[Smart picture]**: Accesses pre-defined smart picture settings.
  - **[Video contrast]**: Adjusts the intensity of video contents, keeping backlight unchanged.
  - **[Contrast]**: Adjusts the intensity of backlight areas, keeping video contents unchanged.
  - **[Brightness]**: Adjusts the intensity and details of dark areas.
  - **[Colour]**: Adjusts colour saturation.
  - **[Hue]**: Compensates for colour variations.
  - **[Sharpness]**: Adjusts sharpness in the image.
  - **[Noise reduction]**: Filters and reduces noise in an image.
  - **[Tint]**: Adjusts the colour balance in an image.
  - **[Custom tint]**: Customises tint setting. (Only available if **[Tint] > [Custom]** is selected)
  - **[Digital Crystal Clear]**: Fine-tunes each pixel to match surrounding pixels. This produces a brilliant, high-definition image.
    - **[Dynamic contrast]**: Enhances contrast. A **[Medium]** setting is recommended.

- **[Dynamic backlight]:** Adjusts brightness of the TV backlight to match lighting conditions.
- **[MPEG artifact reduction]:** Smoothes out transitions on digital pictures. You can switch this feature on or off.
- **[Colour enhancement]:** Makes colours more vivid and improves the details in bright colours. You can switch this feature on or off.
- **[PC mode]:** Adjusts the picture when a PC is connected to the TV via HDMI or DVI.
- **[Picture format]:** Changes the picture format.
- **[Picture size]:** Adjusts the viewing area. (when set to maximum, you might see noise or a rough edge of an image.)
- **[Horizontal shift]:** Adjusts the picture horizontally for PC-VGA, DVI, HDMI or YPbPr.
- **[Vertical shift]:** Adjusts the picture vertically for PC-VGA, DVI, HDMI or YPbPr.

## Change picture format

- 1 Press **FORMAT**.  
↳ A picture format bar appears.
- 2 Press **▲▼** to select a picture format.  
↳ The selected picture format is activated.
- 3 Press **OK** to confirm your choice.

## Summary of picture formats

The following picture settings can be configured.



### Note

- Depending on the format of the picture source, some picture settings are not available.

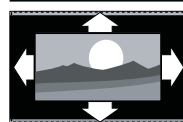

**[Auto format]:** (Not for PC mode.) Automatically displays the suitable picture format. If not, widescreen is applied.

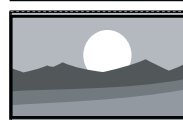

**[Super zoom]:** (Not for HD and PC mode.) Removes the black bars on the side of 4:3 broadcasts. There is minimal distortion.

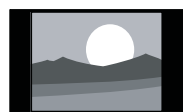

**[4:3]:** Shows the classic 4:3 format.

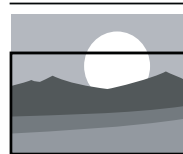

**[Subtitle zoom]:** Displays 4:3 pictures over the full area of the screen, with sub-titles visible. Part of the top of the picture is clipped off.



**[Movie expand 14:9]:** (Not for HD and PC mode.) Scales 4:3 format to 14:9.

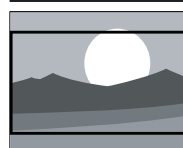

**[Movie expand 16:9]:** (Not for HD and PC mode.) Scales 4:3 format to 16:9.

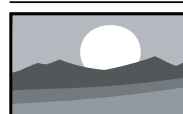

**[Wide screen]:** Scales 4:3 format to 16:9.



**[Unscaled]:** For HD and PC mode only, and in selected models only. Allows maximum sharpness. Some distortion may be present due to the broadcaster's systems. Set your PC resolution to wide screen mode for best results.

---

## Use smart sound

Use smart sound to apply pre-defined sound settings.

- 1 Press **SOUND**.  
↳ The **[Smart sound]** menu appears.
- 2 Press **▲▼** to select the following settings.
  - **[Custom]**: Applies the settings that were customised in the sound menu.
  - **[Standard]**: Adjusts sound settings to suit most environments and types of audio.
  - **[News]**: Applies settings for spoken audio, such as news.
  - **[Movie]**: Applies settings for movies.
- 3 Press **OK** to confirm your choice.  
↳ The selected smart sound setting is applied.

---

## Manually adjust sound settings

- 1 Press **MENU**.
- 2 Press **▲▼◀▶** to select **[Setup] > [Sound]**.  
↳ The **[Sound]** menu appears.
- 3 Press **▲▼◀▶** to select the following settings.
  - **[Smart sound]**: Accesses pre-defined smart sound settings.
  - **[Bass]**: Adjusts the bass level.
  - **[Treble]**: Adjusts the treble level.
  - **[Digital audio lipsync]**: Enables or disables lipsync audio output. When this is enabled, the TV synchronises the audio and video performance. When disabled, you need to adjust the lipsync audio feature on the external device that is connected to the TV. (Only available with SPDIF connection)
  - **[Volume]**: Adjusts the volume.
  - **[Volume visually impaired]**: Sets the mix of visually impaired audio with regular audio. When available, visually impaired audio includes audio descriptions of on-screen action. You can also enable this by pressing **AD (Audio Descriptor)**. (Only applicable for the UK region.)

- **[Balance]**: Adjusts the balance of the right and left speakers.
- **[Audio language]**: Available for digital channels, when multiple languages are broadcast. Lists available audio languages.
- **[Dual I-II]**: Selects audio languages if dual sound broadcast is available.
- **[Mono/Stereo]**: Selects mono or stereo if stereo broadcast is available.
- **[TV speakers]**: Turns TV speakers on or off. (Available only when you switch on Easylink).
- **[Surround]**: Enables spatial sound.
- **[Headphone volume]**: Adjusts headphone volume.
- **[Auto volume levelling]**: Automatically reduces sudden volume changes, for example, when switching channels.
- **[Delta volume]**: Levels out volume differences between channels or connected devices. Switch to the connected device before you change the delta volume.
- **[SPDIF OUT]**: Selects the type of digital audio output.
  - **[PCM]**: Converts non-PCM audio to PCM audio.
  - **[Multichannel]**: Outputs audio to the home theater.



## Use the universal access menu

You can activate the universal access menu during the first installation. Once enabled, you can quickly access the visually impaired and hearing impaired menus when watching TV or external devices.



### Tip

- You can also enable the universal access menu by selecting **[Setup] > [Installation] > [Preferences] > [Universal access] > [On]**.

- When watching TV, press **[MENU] OPTIONS**.  
↳ The TV options menu appears.
- Select **[Universal access]**, then press **OK** or **▶** to enter.
- Press **◀▶** to select one of the following options and press **OK** to enter.
  - [Hearing impaired]**: Enables or disables hearing impaired subtitles.
  - [Visually impaired]**: Selects speaker, headphone or both for **[Volume visually impaired]** audio. Select **[Off]** to disable audio descriptor. (Only applicable to the UK region).
  - [Volume visually impaired]**: Adjusts the volume of visually impaired audio.



### Tip

- Press the colour buttons on the remote control to enter the options.

## Use advanced teletext features

### Access the teletext options menu

Access the teletext features through the teletext options menu.

- Press **MHEG/TELETEXT**.  
↳ The teletext screen appears.
- Press **[MENU] OPTIONS**.  
↳ The teletext options menu appears.
- Press **▲▼** to select one of the following options.
  - [Reveal]**: Hides or reveals hidden information on a page, such as solutions to riddles or puzzles.
  - [Cycle subpage]**: Cycles through subpages automatically if subpages are available.
  - [Language]**: Switches to a different language group to display a language correctly when it uses a different character set.
  - [Freeze page]**: Freezes the current page.
  - [Dual screen] / [Full Screen]**: Enables and disables dual screen teletext.
- Press **▲▼◀▶** to make a selection, then press **OK** to confirm.
- Press **↩ BACK** to exit the teletext options menu.

### Select teletext subpages

A teletext page can hold several subpages. Subpages are displayed on a bar next to the main page number.

- Press **MHEG/TELETEXT**.  
↳ The teletext screen appears.
- Press **▲▼** to select a teletext page.
- Press **◀▶** to enter a subpage.

---

## Select T.O.P. teletext broadcasts

Table Of Pages (T.O.P.) teletext broadcasts allow you to jump from one subject to another without using page numbers. T.O.P. teletext is not broadcast on all TV channels.

- 1 Press **MHEG/TELETEXT**.  
↳ The teletext screen appears.
- 2 Press **INFO**.  
↳ The T.O.P. overview appears.
- 3 Press **▲▼◀▶** to select a subject.
- 4 Press **OK** to view the page.

---

## Create and use list of favourite channels

You can create a list of your preferred TV channels so that you can find those channels easily.

---

### Select a favourite list

- 1 When watching TV, press **OK** to display the channel grid.
- 2 Press **OPTIONS**.  
↳ The channel options menu appears.
- 3 Press **▲▼** to select **[Select list]**, then press **OK** to enter.  
↳ The channel list options appear.
- 4 Select **[Favourite]**, then press **OK**.  
↳ Only channels in the favourite list appear in the channel grid.

 **Note**

- The favourite channel grid is empty until you add channels into the favourite lists.

---

## View all channels

You can exit a favourite list, and view all installed channels.

- 1 When watching TV, press **OK**.  
↳ The channel grid appears.
- 2 Press **OPTIONS**.  
↳ The channel options menu appears.
- 3 Press **▲▼** to select **[Select list]**, then press **OK** or **▶** to enter.
- 4 Select **[All]**, then press **OK**.  
↳ All channels are displayed in the channel grid.

 **Note**

- All favourite channels are marked by an asterisk when you view the channel grid.

---

## Add a channel to a favourite list

 **Tip**

- View all channels before adding a channel to a favourite list.

- 1 When watching TV, press **OK**.  
↳ The channel grid appears.
- 2 Press **▲▼◀▶** to select a channel to add to a favourite list.
- 3 Press **OPTIONS**.  
↳ The channel options menu appears.
- 4 Select **[Mark as favourite]**, then press **OK**.  
↳ The channel is added to the favourite list.

 **Note**

- All favourite channels are marked by an asterisk in the channel grid.

## Remove a channel from a favourite list

- 1 When watching TV, press **OK**.  
↳ The channel grid appears.
- 2 Press **▲▼◀▶** to select a channel to remove.
- 3 Press **☰** **OPTIONS**.
- 4 Select **[Unmark as favourite]**, then press **OK**.  
↳ The channel is removed.

## Use the Electronic Programme Guide

EPG is an on-screen guide available for digital channels. EPG allows you to:

- View a list of digital programmes being broadcast
- View upcoming programmes
- Group programmes by genre
- Set reminders when programmes start
- Set up preferred EPG channels

### Switch on EPG

- 1 When watching TV, press **☰** **GUIDE**.  
↳ The EPG planner screen appears displaying information about the scheduled programmes.

#### Note

- EPG data is available only in selected countries and can take some time to load.

#### Tip

- Press **☰** **GUIDE** to switch between EPG and channel grid.

## Use EPG

- 1 When watching TV, press **☰** **GUIDE**.  
↳ The EPG planner screen appears.
- 2 Press **▲** **MENU**.  
↳ The program guide menu appears.
- 3 Press **▲▼◀▶** to select an option, and then press **OK** to confirm.
- 4 Press **▲** **MENU** to exit the EPG menu.

#### Note

- Only the channels in the **[Preferred EPG channels]** list appear in the EPG menu.

## Use the EPG options menu

Use the EPG options menu to set or clear reminders, change day and access other useful EPG options.

- 1 Press **☰** **GUIDE**.
- 2 Press **☰** **OPTIONS**.  
↳ The EPG menu appears.
- 3 Press **▲▼** to select one of the following options.
  - **[Set remind] / [Clear remind]**: Sets or clears programme reminders.
  - **[Change day]**: Sets the EPG day.
  - **[Show info]**: Displays programme information.
  - **[Search by genre]**: Searches TV programmes by genre.
  - **[Scheduled reminders]**: Lists programme reminders. Only available for upcoming programmes.
  - **[Preferred EPG channels]**: Sets preferred EPG channels.
- 4 Press **OK** to enter or activate the option.
- 5 Press **↶** **BACK** to exit the EPG menu.

#### Tip

- Press **☰** **GUIDE** to switch between EPG and channel grid.

---

## Use the TV clock

You can display a clock on the TV screen. The clock displays the current time using time data received from your TV service operator.

---

### Set the TV clock manually

In some countries, you need to set TV clock manually.

- 1 Press **MENU**.
- 2 Select **[Setup] > [Features] > [Clock]**.  
↳ The **[Clock]** menu appears.
- 3 Press **▲▼◀▶** to enter time.
- 4 Select **[Done]** to confirm.
- 5 Press **MENU** to exit.



#### Note

- If your selected country supports digital broadcast, the clock displays the time data from your TV service operator as priority.

---

### Display the TV clock

- 1 When watching TV, press **OPTION**.  
↳ The TV option menu appears.
- 2 Select **[Clock]**.
- 3 Press **OK**.



#### Note

- To disable the clock, repeat the above procedure.

---

## Change the clock mode

- 1 Press **MENU**.
- 2 Press **▲▼◀▶** to select **[Setup] > [Installation] > [Clock] > [Auto clock mode]**.
- 3 Press **▲▼** to select **[Automatic]** or **[Manual]**.
- 4 Press **OK** to confirm.

---

## Change the time zone

- 1 Press **MENU**.
- 2 Press **▲▼◀▶** to select **[Setup] > [Installation] > [Clock] > [Time zone]**.
- 3 Press **▲▼** to select your time zone.
- 4 Press **OK** to confirm.



#### Note

- This option is only available if you select **[Auto clock mode] > [Manual]** (in countries with clock transmission data).

---

## Use daylight saving

- 1 Press **MENU**.
- 2 Press **▲▼◀▶** to select **[Setup] > [Installation] > [Clock] > [Daylight saving]**.
- 3 Press **OK** or **▶** to enter **[Daylight saving]**.
- 4 Press **▲▼** to select **[Standard time]** or **[Daylight saving time]**.
- 5 Press **OK** to confirm.



#### Note

- This option is only available if you select **[Auto clock mode] > [Manual]**.

## Use timers

You can set timers to switch the TV to standby at a specified time.



### Tip

- Set the TV clock before you use timers.

## Automatically switch the TV to standby (sleep timer)

Sleep timer switches the TV to standby after a pre-defined period of time.



### Tip

- You can switch off your TV earlier or reset the sleep timer during the countdown.

- 1 Press **MENU**.
- 2 Press **▲▼◀▶** to select **[Setup] > [Features] > [Sleep timer]**.  
↳ The **[Sleep timer]** menu appears.
- 3 Press **◀▶** to select a value between zero and 180 minutes.  
↳ The sleep timer can be set in steps of five minutes. If set to zero, the sleep timer is switched off.
- 4 Press **OK** to switch on the sleep timer.  
↳ The TV switches to standby after the specified time.

## Automatically switch the TV on (on timer)

You can switch the TV to a specified channel at a specified time, from standby or power-on mode.

- 1 Press **MENU**.
- 2 Press **▲▼◀▶** to select **[Setup] > [Features] > [On timer]**.
- 3 Press **▶** to enter the **[On timer]** menu.
  - **[Activate]**: Selects how often the TV is switched on.
  - **[Time]**: Sets the time to switch on the TV.
  - **[Programme no.]**: Selects the channel or the connected device.
- 4 Press **MENU** to exit.



### Tip

- Select **[On timer] > [Activate] > [Off]** to disable this feature.

---

## Use TV locks

You can prevent your children from watching certain programmes or channels by locking the TV controls.

---

### Set or change your PIN code

- 1 Press **MENU**.
- 2 Press **▲▼◀▶** to select **[Setup] > [Features] > [Set code] / [Change code]**.  
↳ The **[Set code] / [Change code]** menu appears.
- 3 Enter your code using the **Numeric buttons**.  
↳ Follow the on-screen instructions to create or change your PIN code.



#### Tip

- If you forget your code, enter '8888' to override any existing codes.

---

### Lock or unlock the TV

Lock the TV to prevent access to all channels and connected devices.

- 1 Press **MENU**.
- 2 Press **▲▼◀▶** to select **[Setup] > [Features] > [TV lock]**.  
↳ You are prompted to enter your PIN code.
- 3 Enter your code using **Numeric buttons**.  
↳ The **[TV lock]** menu appears.
- 4 Press **▲▼** to select **[Lock]** or **[Unlock]**.
- 5 Press **OK** to confirm.  
↳ All channels and connected devices are locked or unlocked.
- 6 Press **MENU** to exit.



#### Note

- Switch the TV off and on again for the change to take effect.
- If you select **[Lock]**, you have to enter your code every time you turn on your TV.

---

### Lock the TV for a specific time

- 1 Press **MENU**.
- 2 Press **▲▼◀▶** to select **[Setup] > [Features] > [Lock after]**.  
↳ You are prompted to enter your PIN code.
- 3 Enter your code using **Numeric buttons**.
- 4 Select **[On]**.  
↳ The feature menu appears.
- 5 Select **[Time]**, then press **OK**.
- 6 Enter the time with **Numeric buttons** or the **Navigation buttons**.
- 7 Select **[Done]**.  
↳ The TV automatically switches off at the specific time.



#### Note

- You have to enter your code every time you turn on your TV.
- Switch the TV off and on again for the change to take effect.

---

### Lock or unlock one or more channels

- 1 When watching TV, press **OK** to display the channel grid.
- 2 Press **▲▼◀▶** to select a channel to lock or unlock.
- 3 Press **☰** **OPTIONS**.
- 4 Press **▲▼** to select **[Lock channel]** or **[Unlock channel]**.
- 5 For each selection, press **OK** to lock or unlock the channel.  
↳ The first time you lock or unlock a channel, you are prompted to enter your PIN code.
- 6 Enter your code and press **OK**.  
↳ If the channel is locked, a lock icon is displayed.
- 7 Repeat the process to lock or unlock more channels.

**Note**

- Switch the TV off and on again for the change to take effect.
- If you use **P +/-** on your remote control to switch between channels, the locked channels are skipped.
- If you access the locked channels from the channel grid, you are prompted to enter your PIN code.

## Set parental ratings

Some digital broadcasters rate their programmes according to age. You can set your TV to display only programmes with age ratings higher than your child's age.

- 1 Press **MENU**.
- 2 Press **▲▼◀▶** to select **[Setup] > [Features] > [Parental rating]**.  
↳ A code setup screen appears.
- 3 Enter your code using **Numeric buttons**.  
↳ The parental rating menu appears.
- 4 Press **▲▼** to select an age rating.
- 5 Press **OK** to confirm.
- 6 Press **MENU** to exit.

## Use subtitles

You can enable subtitles for each TV channel. Subtitles are broadcast via teletext or DVB-T digital broadcasts. With digital broadcasts, you can select a subtitle language.

### Enable subtitles on analogue TV channels

- 1 Select an analogue TV channel.
- 2 Press **MHEG/TELETEXT**.
- 3 Enter the three-digit page number of the subtitle page with the **Numeric buttons**.
- 4 Press **MHEG/TELETEXT** to switch off teletext.
- 5 Press **SUBTITLE**.  
↳ The **[Subtitle mode]** menu appears.
- 6 Select **[On]** to display subtitles always or **[On during mute]** to display subtitles only when audio is muted.
- 7 Press **OK** to enable subtitles.
- 8 Repeat this procedure to enable subtitles on each analogue channel.

**Tip**

- Select **[Subtitle mode] > [Off]** to disable subtitles.

---

## Enable subtitles on digital TV channels

- 1 When watching digital channels, press **SUBTITLE**.  
↳ The **[Subtitle mode]** menu appears.
- 2 Select **[On]** to display subtitles always or **[On during mute]** to display subtitles only when audio is muted.
- 3 Press **OK** to enable subtitles.

---

## Select a subtitle language on digital TV channels

### Note

- When you select a subtitle language on a digital TV channel as described below, the preferred subtitle language set in the installation menu is temporarily overruled.

- 1 Press **▲ MENU**.
- 2 Press **▲▼◀▶** to select **[Setup] > [Features] > [Subtitle language]**.
- 3 Press **OK** or **▶** to enter the list of available languages.
- 4 Press **▲▼** to select a subtitle language.
- 5 Press **OK** to confirm.

### Tip

- You can also access the **[Subtitle language]** menu while watching TV by pressing **☰ OPTIONS > [Subtitle language]**.

---

## View photos and play music from a USB storage device

### Caution

- Philips is not responsible if the USB storage device is not supported, nor is it responsible for damage or loss of data from the device.

Use the USB connector to view photos or listen to music stored on a USB storage device.

- 1 Turn on the TV.
- 2 Connect the USB storage device to the TV.  
↳ The home menu appears.
- 3 Press **▲▼◀▶** to select **[Browse USB]**.
- 4 Press **OK** to confirm.  
↳ The USB thumbnail browser appears.

### Tip

- Press **☰ GUIDE** to switch between thumbnail and file browsing views.

---

## View photos

- 1 In the USB browser, press **▶** to enter the **[Picture]** folder.
- 2 Press **▲▼◀▶** to select a photo or a photo album.
- 3 Press **OK** to view a full screen image of the photo.

### Tip

- When in full screen mode, press **◀▶** to move between photos.



## View a slide show of your photos

- 1 When a full screen image of a photo is displayed, press **OK**.
  - ↳ A slide show begins from the selected photo.
- 2 Press the following buttons to control the slide show:
  - **OK** to pause the slide show.
  - **◀▶** to go back or move forward to the next image.
  - **↶ BACK** to stop the slide show.

## Change slide show settings

- 1 When viewing a slide show, press **☰ OPTIONS**.
  - ↳ The slide show options menu appears.
- 2 Press **▲▼** to select one of the following.
  - **[Start Slideshow] / [Stop Slideshow]**: Starts or stops a slide show.
  - **[Slideshow transitions]**: Sets the transition from one picture to the next.
  - **[Slideshow frequency]**: Sets the amount of time that a picture is shown.
  - **[Rotate image]**: Rotates a picture.
  - **[Show info]**: Displays the picture name, date, size and next picture in the slide show.
- 3 Press **OK** to confirm your setting.



### Note

- **[Rotate image]** and **[Show info]** appear only when you press **OK** to pause the slideshow.

## Listen to music

- 1 In the USB thumbnail browser view, select **[Music]** and press **▶** to enter.
  - Press **☰ GUIDE** to switch between thumbnail and file browsing views.
- 2 Press **▲▼◀▶** to select a music track or album.
- 3 Press **OK** to play the selected music.

Button	Function
<b>OK</b>	Pause, resume play or stop playback.
<b>◀ / ▶</b>	Go to the previous or next music.

## Music settings

When listening to music, press **☰ OPTIONS** to access one of the following music settings.

- **[Start playback] / [Stop playback]**: Starts or stops the music.
- **[Repeat] / [Play once]**: Repeats a song. / Disables repeat play and plays a song or album once.
- **[Shuffle on] / [Shuffle off]**: Enables or disables random play of songs.
- **[Show info]**: Displays the file name.
- **[TV speakers]** (Available only when you activate Easylink): Sets the TV speakers on or off.
- **[Sound]**: Adjusts the sound setting.

## View a slideshow with music

You can view a picture slide show with background music.

- 1 Select an album of songs.
- 2 Press **OK**.
- 3 Press **↶ BACK** to return to the USB content browser.
- 4 Select an album of pictures.
- 5 Press **OK**.

---

## Disconnect a USB storage device

### Caution

- Follow this procedure to avoid damage to your USB storage device.

- 1 Press **↩** **BACK** to exit the USB browser.
- 2 Wait for five seconds then disconnect the USB storage device.

---

## Listen to digital radio channels

If digital broadcasting is available, digital radio channels are installed automatically during installation.

- 1 When watching TV, press **OK** to display the channel grid.
- 2 Press **☰** **OPTIONS**.
- 3 Press **▲▼** to select **[Select list] > [Radio]**.  
↳ The radio channel grid appears.
- 4 Press **▲▼◀▶** to select a radio channel and press **OK** to listen.

### Note

- Select **[Select list] > [All]** to exit radio channels and view all channels.

---

## Update the TV software

Philips continuously tries to improve its products and we recommend that you update the TV software when updates are available. Check [www.philips.com/support](http://www.philips.com/support) for availability.

---

### Check the current software version

- 1 Press **▲** **MENU**.
- 2 Press **▲▼◀▶** to select **[Setup] > [Software update] > [Current software inf]**.  
↳ The TV displays the current software information.

---

### Download the software

- 1 On your PC, open a web browser and go to [www.philips.com/support](http://www.philips.com/support).
- 2 Download the latest software upgrade file to your PC.
- 3 Decompress the ZIP-file.
- 4 Copy the autorun.upg file to the root directory of the USB device.

---

### Update software

You can update the TV software via a USB storage device or OAD (Over the Air software Download).

---

### Update using a USB device

Connect your USB storage device to the TV.

- 1 If the software update screen does not appear automatically, select **[Setup] > [Software update] > [Local updates] > [USB]**.
- 2 Press **OK** to update the TV software manually.
- 3 Follow the on-screen instructions to complete the update.



## Note

- The TV restarts after the software update is complete.

## Update using OAD

- 1 If using (DVB-T) digital broadcast, your TV automatically receives software updates. If you receive a message on your screen asking you to update your software:
  - Select **[Update now]** to update the software immediately.
  - Select **[Remind me later]** to exit the update screen at that time and be reminded later.
  - Select **[Cancel]** to skip the update.
- 2 If you select **[Cancel]**, you can manually access the OAD update by selecting **[Setup] > [Software update] > [Local updates] > [OAD]**.
- 3 Select the available version of OAD and press **OK**.
- 4 Follow the on-screen instructions to start the update.



## Note

- The TV restarts after the software update is complete.

## Change TV preferences

Use the preferences menu to customise your TV settings.

- 1 Press **HOME MENU**.
- 2 Select **[Setup] > [Installation] > [Preferences]**.
  - **[Location]**: Optimises TV settings for your location - home or shop.
  - **[Volume bar]**: Displays the volume bar when you adjust the volume.
  - **[Channel Information]**: Displays information about the TV channel every time you switch channels. Select **[Full]** to view channel information or **[Off]** to turn off the channel information.
  - **[Universal access]**: Enables or disables the universal access menu.
  - **[EasyLink]**: Enables one-touch play and one-touch standby between EasyLink-compliant devices.
  - **[Pixel Plus Link]**: Overrides the settings of connected devices and uses the settings of the TV. (Available only when you activate Easylink).
  - **[E-sticker]**: For shop mode only. Sets the location of the e-sticker.
- 3 Press **▲▼◀▶** to select your preference.
- 4 Press **OK**.
- 5 Press **HOME MENU** to exit.

---

## Access decoder channel

You can map channels provided through a decoder or descrambler to your TV channel selection. In this way, you can select these channels by using the RC of your TV. The decoder or a descrambler must be connected to EXT1 (SCART).

---

### Set decoder channel

Map channels from a decoder or descrambler.

- 1 Press **▲** MENU.
- 2 Select **[Setup] > [Installation] > [Decoder]**.
- 3 Press **▶** to enter **[Decoder]** menu.
- 4 Press **▲▼** to select **[Channel]**, then press **▶** to enter.
- 5 Select one channel to map to the decoder / descrambler channel and press **OK** to confirm.
- 6 Select **[Status]**, then press **▶** to enter.
- 7 Select **[EXT 1]** (SCART) the connector used by the decoder / descrambler.
- 8 Press **OK**.
- 9 Press **▲** MENU to exit.

#### Note

- Select **[None]** if you do not want to map to the decoder / descrambler channel.

---

## Start a TV demo

You can use demonstrations to better understand the features of your TV. Some demos are not available on certain models. Available demos are displayed in the menu list.

- 1 Press **DEMO** on the remote control.
- 2 Press **▲▼** to select a demo and press **OK** to view it.
- 3 Press **DEMO** to exit.

---

## Reset the TV to factory settings

You can restore the default picture and sound settings of your TV. The channel installation settings remain the same.

- 1 Press **▲** MENU.
- 2 Select **[Setup] > [Installation] > [Factory settings]**.
- 3 Press **▶** to enter **[Factory settings]**.
- 4 Select **[Reset]** to start resetting.
- 5 Press **OK**.
- 6 Press **▲** MENU to exit.

# 6 Install channels

The first time you set up your TV, you are prompted to select a menu language and to install TV and digital radio channels (if available). This chapter provides instructions on how to re-install and fine tune channels.

---

## Automatically install channels

This section describes how to search and store channels automatically.

---

### Step 1 Select your menu language

- 1 Press **MENU**.
- 2 Press **▲▼◀▶** to select **[Setup] > [Installation] > [Language] > [Menu language]**.
- 3 Press **OK** or **▶** to enter **[Menu language]**.
- 4 Press **▲▼** to select a language.
- 5 Press **OK** to confirm.
- 6 Press **◀** to return to **[Installation]** menu.

---

### Step 2 Select your country

Select the country where you are installing the TV. The available channels for the country are installed on the TV.

- 1 Press **MENU**.
- 2 Press **▲▼◀▶** to select **[Setup] > [Installation] > [Channel installation] > [Automatic channel search]**.
- 3 Press **OK** or **▶** to enter the menu.  
↳ The country menu appears.
- 4 Press **▲▼** to select your country.
- 5 Press **OK** to confirm your choice.  
↳ The channel installation guide appears on the screen.

---

### Step 3 Install channels

Automatically installs the available analogue and digital TV channels and digital radio channels.

- 1 From the channel installation guide screen, select **[Full installation]**.
- 2 Press **OK** to confirm.  
↳ The TV starts to search and store all the available channels.
- 3 When installation is complete, press **OK** to exit the installation menu.

---

### Update the channel list

You can enable automatic update of channels when your TV is in standby mode. The channels stored in your TV are updated every morning according to the channel information in the broadcast.

- 1 Press **MENU**.
- 2 Press **▲▼◀▶** to select **[Setup] > [Installation] > [Channel installation] > [Standby update]**.
- 3 Select **[On]** to enable the automatic update or select **[Off]** to disable it.

---

## Manually install channels

This section describes how to search and store analogue TV channels manually.

---

### Step 1 Select your system

#### Note

- Skip this step if your system settings are correct.

- 1 Press **MENU**.
- 2 Press **▲▼◀▶** to select **[Setup] > [Installation] > [Channel installation] > [Analogue: manual install]**.  
↳ The **[Analogue: manual install]** menu appears.
- 3 Press **▲▼** to select **[System]**, then press **▶** to enter.
- 4 Press **▲▼** to select your country or region.
- 5 Press **OK** to confirm.
- 6 Press **◀** to return to **[Channel installation]** menu.

---

### Step 2 Search and store new TV channels

- 1 Press **MENU**.
- 2 Press **▲▼◀▶** to select **[Setup] > [Installation] > [Channel installation] > [Analogue: manual install]**.  
↳ The **[Analogue: manual install]** menu appears.
- 3 Press **▲▼** to select **[Search]**, then press **▶** to enter.
- 4 Press **▲▼◀▶** to manually enter the three-digit frequency.
- 5 Press **OK** to begin search.  
↳ If a channel is unavailable at the selected frequency, press **OK** to search for the next available channel.

- 6 Press **↩ BACK** when the new channel is found.
- 7 Press **▲▼** to select **[Store as new channel]** to store the new channel under a new channel number.
- 8 Press **OK** to enter **[Store as new channel]**, then press **OK**.
- 9 Press **◀** to return to the **[Channel installation]** menu.

---

### Step 3 Fine-tune analogue channels

- 1 Press **MENU**.
- 2 Press **▲▼◀▶** to select **[Setup] > [Installation] > [Channel installation] > [Analogue: manual install]**.  
↳ The **[Analogue: manual install]** menu appears.
- 3 Press **▲▼** to select **[Fine tune]**, then press **▶** to enter.
- 4 Press **▲▼** to adjust frequency.
- 5 Press **OK** to confirm.
- 6 Press **▲▼** to select **[Store current channel]** to store the channel number.
- 7 Press **▶** to enter **[Store current channel]**, then press **OK**.
- 8 Press **◀** to return to the **[Channel installation]** menu.

## Rename channels

You can rename channels. The name appears when you select the channel.

- 1 When watching TV, press **OK** to display the channel grid.
- 2 Select the channel to rename.
- 3 Press **⏏** **OPTIONS**.  
↳ The channel options menu appears.
- 4 Press **▲▼** to select **[Rename channel]**, then press **OK**.  
↳ A text input box appears.
- 5 Press **▲▼◀▶** to select characters.
- 6 Press **OK** to confirm each character.
- 7 Select **[Done]**, then press **OK** to finish renaming channels.



### Tip

- Press **[Aa]** to change an uppercase letter to a lowercase letter and vice versa.

## Rearrange channels

After you install channels, you can rearrange the order in which they appear:

- 1 When watching TV, press **OK** to display the channel grid.
- 2 Press **⏏** **OPTIONS**.  
↳ The channel options menu appears.
- 3 Press **▲▼** to select **[Reorder]**, then press **OK**.
- 4 Select the channel to rearrange, then press **OK**.  
↳ The selected channel is highlighted.
- 5 Press **▲▼◀▶** to move the highlighted channel to the desired location, then press **OK**.
- 6 Press **⏏** **OPTIONS**.  
↳ **[Done reordering]** appears on the screen.
- 7 Press **OK** to confirm.
- 8 Press **↶** **BACK** to exit the channel grid.

---

## Test digital reception

You can check the quality and signal strength of digital channels. This allows you to reposition and test your antenna or satellite dish.

- 1 Press **MENU**.
- 2 Press **▲▼◀▶** to select **[Setup] > [Installation] > [Channel installation] > [Manual channel search]**.
- 3 Press **▶** to enter the menu.
- 4 Press **▲▼◀▶** to enter the frequency of the channel you want to test.
- 5 Press **OK** to confirm the frequency, then press **OK** again to confirm **[Search]**.
- 6 When complete, select **[Store]** to store the frequency.



### Note

- If the signal quality and strength is poor, reposition the aerial or satellite dish and retest.
- If you still have problems with the reception of your digital broadcast, contact a specialised installer.



# 7 Connect devices

This section describes how to connect devices with different connectors. Examples are provided in the Quick Start.

**Note**

- You can use different types of connectors to connect a device to your TV.

## Back connector

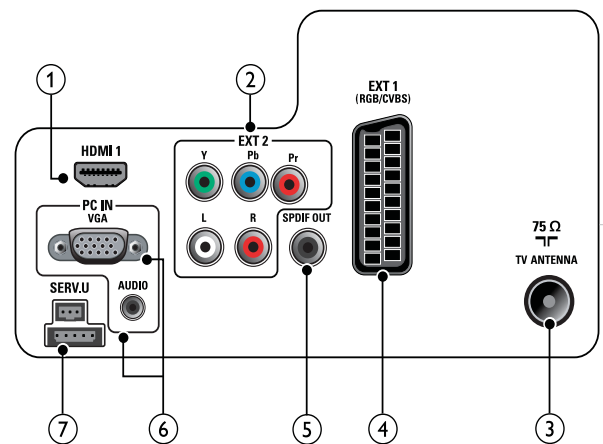

- ① **HDMI 1**  
Digital audio and video input from high-definition digital devices such as Blu-ray players.

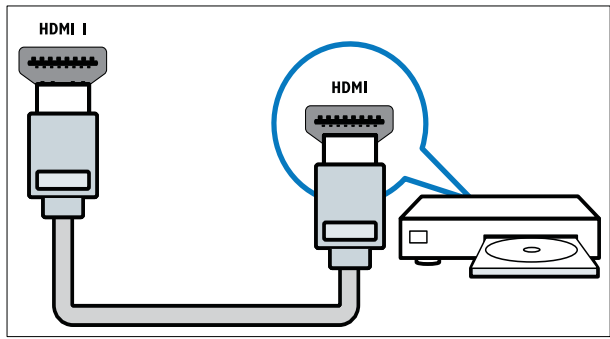

Connections via DVI or VGA require an additional audio cable (see 'Connect a computer' on page 34).

- ② **EXT 2 (Y Pb Pr and AUDIO L/R)**  
Analogue audio and video input from analogue or digital devices such as DVD players or game consoles.

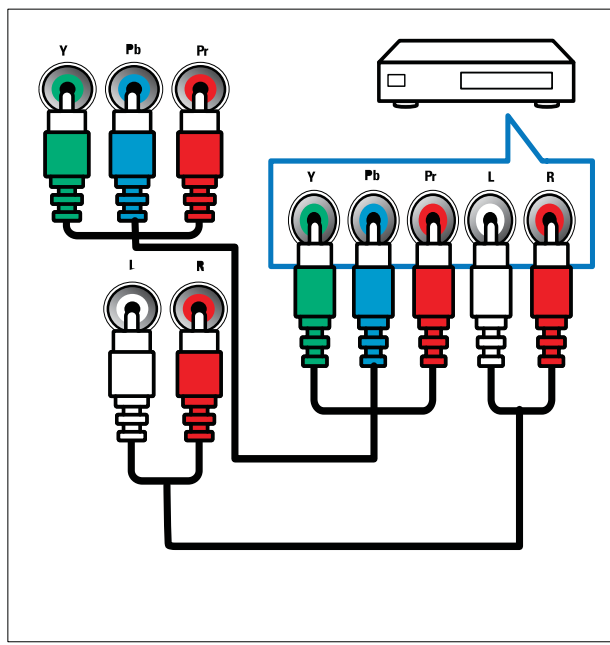

- ③ **TV ANTENNA**  
Signal input from an antenna, cable or satellite.

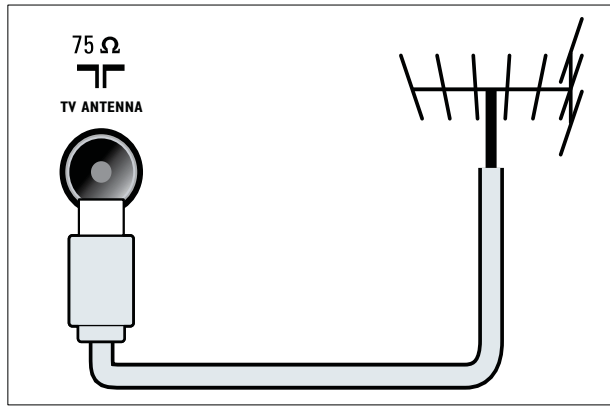

#### ④ EXT 1 (CVBS and RGB)

Analogue audio and video input from analogue or digital devices such as DVD players or game consoles.

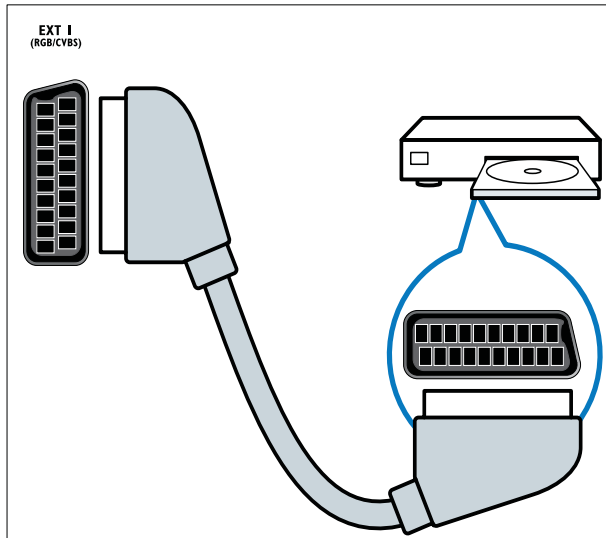

#### ⑤ SPDIF OUT

Digital audio output to home theatres and other digital audio systems.

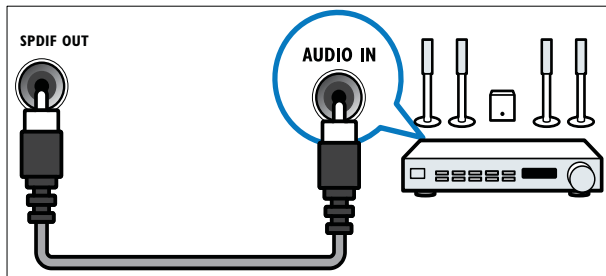

#### ⑥ PC IN (VGA and AUDIO)

Audio and video input from a computer.

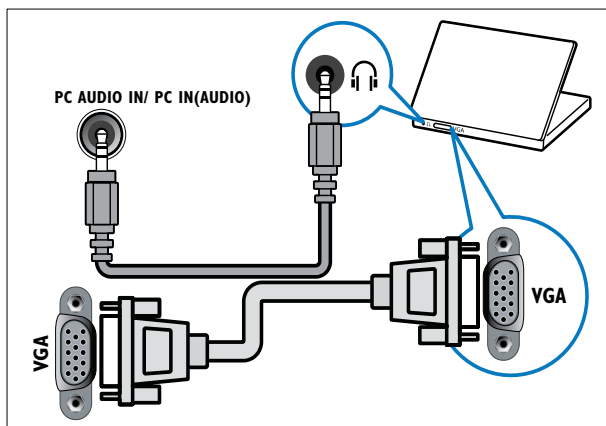

#### ⑦ SERV. U

For software update.

## Side connector

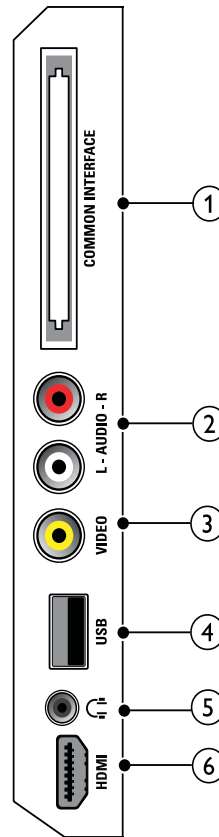

#### ① COMMON INTERFACE

Slot for a Conditional Access Module (CAM).

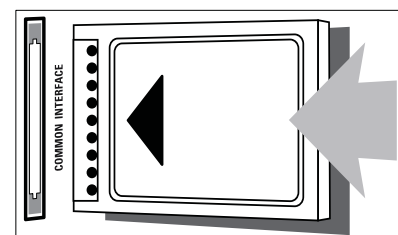

- ② **AUDIO L/R**  
Audio input from analogue devices connected to **VIDEO**.

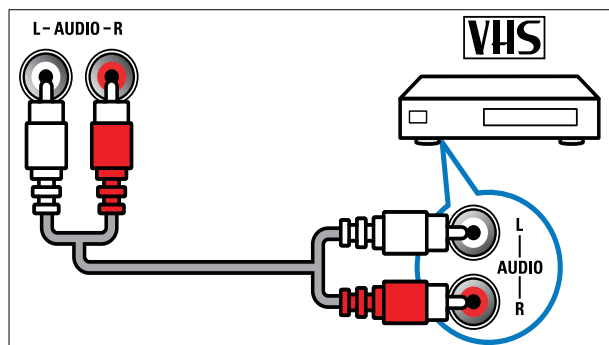

- ③ **VIDEO**  
Composite video input from analogue devices such as VCRs.

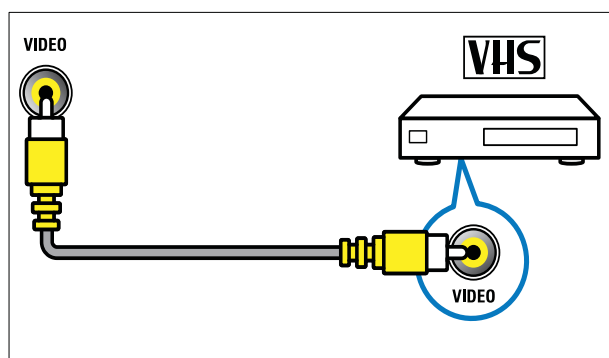

- ④ **USB**  
Data input from USB storage devices.

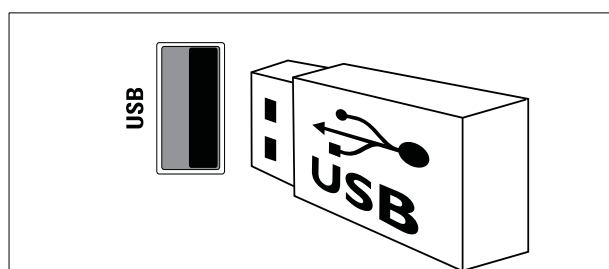

- ⑤ **🎧 (Headphone)**  
Stereo audio output to headphones or earphones.

- ⑥ **HDMI (Available only in 26 inch TV)**  
Digital audio and video input from high-definition digital devices such as Blu-ray players.

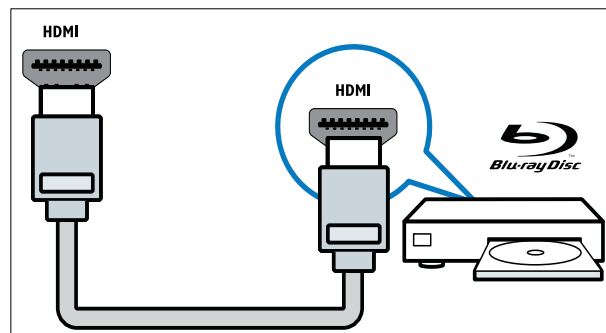

# Connect a computer

## Before you connect a computer to the TV

- Set the screen refresh rate on your computer to 60Hz.
- Select a supported screen resolution on your computer.

Connect a computer with one of the following connectors:

### Note

- Connections via DVI or VGA require an additional audio cable.

- HDMI cable

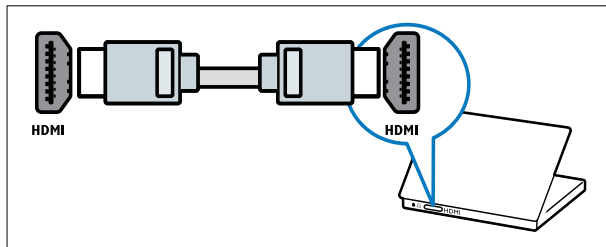

- DVI-HDMI cable

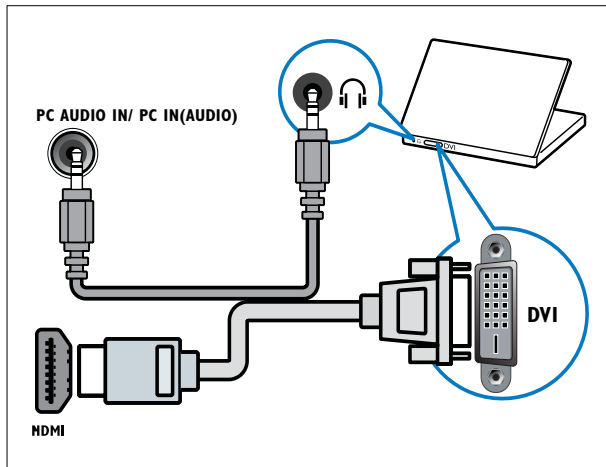

- HDMI cable and HDMI-DVI adaptor

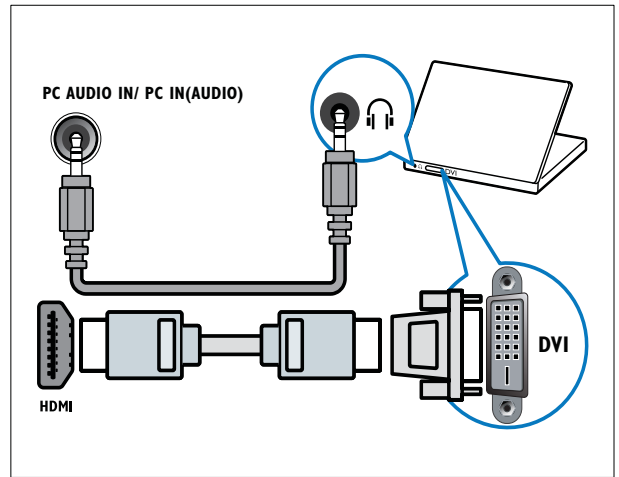

- VGA cable

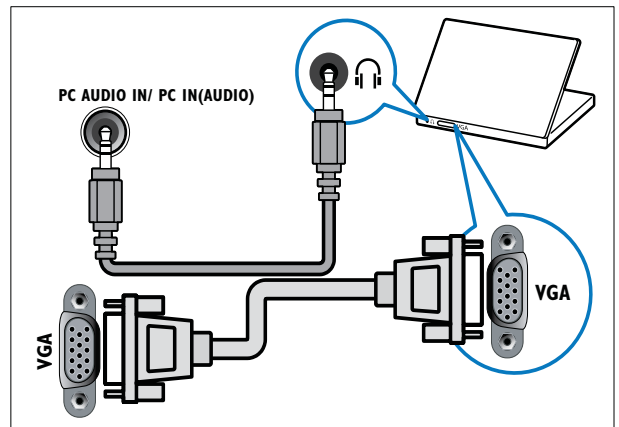

## Use a Conditional Access Module

A Conditional Access Module (CAM) is provided by digital TV service operators to decode digital TV channels.

### Note

- Refer to the documentation from your service operator on how to insert a smart card into the Conditional Access Module.

## Insert and activate a CAM

### Caution

- Be sure to follow the instructions described below. Wrong insertion of a CAM may damage both the CAM and your TV.

- 1 Switch off the TV and disconnect it from the power outlet.
- 2 Following the directions printed on the CAM, gently insert the CAM into the **COMMON INTERFACE** at the side of the TV.

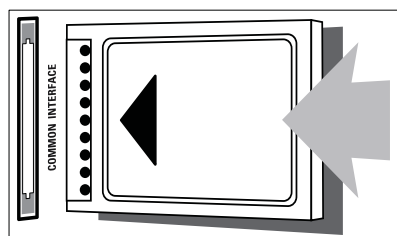

- 3 Push the CAM in as far as it will go.
- 4 Reconnect the TV to the power outlet.
- 5 Turn on the TV and wait for the CAM to be activated. This may take several minutes. Do not remove the CAM from the slot when in use — removing the CAM will deactivate digital services.

## Access CAM services

- 1 After inserting and activating the CAM, press **MENU**.
- 2 Press **▲▼◀▶** to select **[Setup] > [Features] > [Common interface]**.
  - ↳ Applications provided by the digital TV service operator appear on the screen.

### Note

- This menu option is available only if the CAM is inserted and activated correctly.

---

## Use Philips EasyLink

Your TV supports Philips EasyLink, which uses the HDMI CEC (Consumer Electronics Control) protocol. EasyLink-compliant devices that are connected through HDMI connectors can be controlled by a single remote control.

### Note

- The EasyLink-compliant device must be switched on and selected as the source.
- Philips does not guarantee 100% interoperability with all HDMI CEC devices.

---

## EasyLink features

### One-touch play

When you connect your TV to devices that support one-touch play, you can control your TV and the devices with one remote control.

### One-touch standby

When you connect your TV to devices that support standby, you can use your TV remote control to put your TV and all connected HDMI devices in standby mode.

### System audio control

When you connect your TV to HDMI CEC compliant devices, your TV can switch automatically to play audio from the connected device.

To use one-touch audio, you must map the audio input from the connected device to your TV.

You can use the remote control from the connected device to adjust the volume.

---

## Enable or disable EasyLink

### Note

- Do not enable Philips EasyLink if you do not intend to use it.

- 1 Press **MENU**.
- 2 Press **▲▼◀▶** to select **[Setup] > [Installation] > [Preferences] > [EasyLink]**.
- 3 Select **[On]** or **[Off]**.

---

## Use one-touch play

- 1 After enabling EasyLink, press play on your device.
  - ↳ The TV automatically switches to the correct source.

---

## Use one-touch standby

- 1 Press **⏻ (Standby-On)** on the TV's or device's remote control.
  - ↳ The TV and all connected HDMI devices switch to standby.

## Set TV speakers to EasyLink mode

When you play content from an EasyLink compliant home theater, the TV speakers are automatically muted.

- 1 Enable one-touch play and one-touch standby between your Easylink compliant devices by following the instructions in the previous section (see 'Enable or disable EasyLink' on page 36).
- 2 Press **▲ MENU**.
- 3 Press **▲▼◀▶** to select **[Setup] > [Sound] > [TV speakers] > [Auto EasyLink]**.  
↳ The TV speakers are turned off automatically when content from an Easylink compliant system is detected.
- 4 Press **▲▼◀▶** to select **[Setup] > [Sound] > [TV speakers] > [On]** to disable system audio control and enable the TV speakers.



### Note

- To mute the TV speakers, select **[TV speakers] > [Off]**.

## Use a Kensington lock

There is a Kensington security slot at the back of the TV. Prevent theft by looping a Kensington lock between the slot and a permanent object, such as a heavy table.

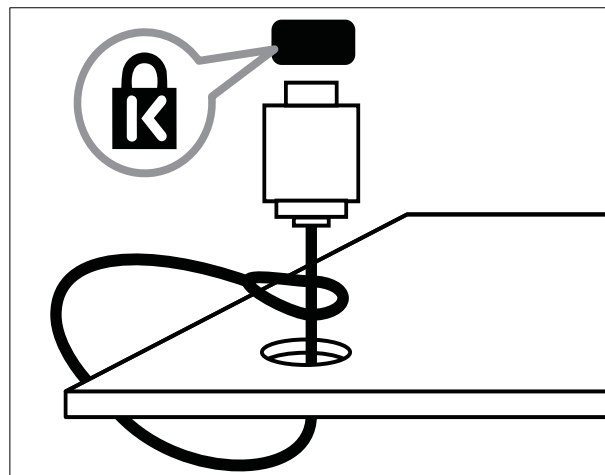

# 8 Product information

Product information is subject to change without notice. For detailed product information, go to [www.philips.com/support](http://www.philips.com/support).

---

## Supported display resolutions

### Computer formats

- Resolution - refresh rate:
  - 640 × 480 - 60Hz
  - 800 × 600 - 60Hz
  - 1024 × 768 - 60Hz
  - 1280 × 720 - 60Hz
  - 1280 × 1024 - 60 Hz
  - 1360 × 768 - 60Hz

### Video formats

- Resolution - refresh rate:
  - 480i - 60Hz
  - 480p - 60Hz
  - 576i - 50Hz
  - 576p - 50Hz
  - 720p - 50Hz, 60Hz
  - 1080i - 50Hz, 60Hz
  - 1080p - 24Hz, 25Hz, 30Hz, 50Hz, 60Hz.

---

## Multimedia

- Supported storage device: USB (Only FAT or FAT 32 USB storage devices are supported)
- Supported multimedia file formats:
  - Images: JPEG
  - Audio: MP3



### Note

- Multimedia file names must not exceed 128 characters.

---

## Tuner / Reception / Transmission

- Aerial input: 75ohm coaxial (IEC75)
- DVB: DVB Terrestrial, DVB-T MPEG4
- TV system: DVB COFDM 2K/8K; PAL I, B/G, D/K; SECAM B/G, D/K, L/L'
- Video playback: NTSC, SECAM, PAL
- Tuner Bands: Hyperband, S-channel, UHF, VHF

---

## Remote control

- Type: PF01E09B
- Batteries: 2 × AAA (LR03 type)

---

## Power

- Mains power: 220-240V, 50Hz
- Standby power: < 0.3 W
- Ambient temperature: 5 to 40 degrees Celsius



## Supported TV mounts

To mount the TV, purchase a Philips TV mount. To prevent damage to cables and connectors, be sure to leave a clearance of at least 2.2 inches or 5.5cm from the back of the TV.



### Warning

- Follow all instructions provided with the TV mount. Koninklijke Philips Electronics N.V. bears no responsibility for improper TV mounting that results in accident, injury or damage.

TV screen size (inches)	Required pitch (mm)	Required mounting bolts ( $\leq 10\text{mm}$ )
22	75 x 75	4 x M4

## Product specification

Design and specifications are subject to change without notice.

### 22PFL3415H

- Without TV stand
  - Dimension (WxHxD): 526.02 x 343.5 x 55.79 (mm)
  - Weight: 4.0 kg
- With TV stand
  - Dimension (WxHxD): 526.02 x 369.5 x 148.96 (mm)
  - Weight: 4.2 kg

# 9 Troubleshooting

This section describes commonly encountered issues and accompanying solutions.

---

## General TV issues

### The TV does not switch on:

- Disconnect the power cable from the power outlet. Wait for one minute then reconnect it.
- Check that the power cable is securely connected.

### The remote control is not working properly:

- Check that the remote control batteries are correctly inserted according to the +/- orientation.
- Replace the remote control batteries if they are flat or weak.
- Clean the remote control and TV sensor lens.

### The standby light on the TV blinks red:

- Disconnect the power cable from the power outlet. Wait until the TV cools down before reconnecting the power cable. If the blinking reoccurs, contact Philips Consumer Care.

### You forgot the code to unlock the TV lock feature

- Enter '8888'.

### The TV menu is in the wrong language.

- Change the TV menu to your preferred language.

### When turning the TV on / off / to standby, you hear a creaking sound from the TV chassis:

- No action is required. The creaking sound is normal expansion and contraction of the TV as it cools down and warms up. This does not impact performance.

---

## TV channel issues

### Previously installed channels do not appear in the channel list:

- Check that the correct channel list is selected.

### No digital channels were found during the installation:

- Check that the TV supports DVB-T, DVB-T Lite or DVB-C in your country.

### Some channels are not automatically installed on my TV:

- During installation, make sure that you select the country where you are installing the TV (see 'Step 2 Select your country' on page 27).

---

## Picture issues

### The TV is on, but there is no picture:

- Check that the antenna is properly connected to the TV.s
- Check that the correct device is selected as the TV source.

### There is sound but no picture:

- Check that the picture settings are correctly set.

### There is poor TV reception from an antenna connection:

- Check that the antenna is properly connected to the TV.
- Loudspeakers, unearthed audio devices, neon lights, high buildings and other large objects can influence reception quality. If possible, try to improve the reception quality by changing the antenna direction or moving devices away from the TV.
- If reception on only one channel is poor, fine tune this channel.

### There is poor picture quality from connected devices:

- Check that the devices are connected properly.
- Check that the picture settings are correctly set.

**The TV did not save your picture settings:**

- Check that the TV location is set to the home setting. This mode offers you the flexibility to change and save settings.

**The picture does not fit the screen; it is too big or too small:**

- Try using a different picture format.

**The picture position is incorrect:**

- Picture signals from some devices may not fit the screen correctly. Check the signal output of the device.

**Cannot remove 'e-sticker' banner displayed on the TV.**

- To remove the logos and images, set the location of your TV to home.
  1. Press **MENU**.
  2. Select **[Setup] > [Installation] > [Preferences] > [Location]**.
  3. Select **[Home]** and press **OK**.

---

## Sound issues

**There is a picture but sound quality is poor:** **Note**

- If no audio signal is detected, the TV automatically switches the audio output off — this does not indicate malfunction.

- Check that all cables are properly connected.
- Check that the volume is not set to 0.
- Check that the sound is not muted.

**There is a picture but the sound quality is poor:**

- Check that the sound settings are correctly set.

**There is a picture but sound comes from one speaker only:**

- Verify that sound balance is set to the centre.

---

## HDMI connection issues

**There are problems with HDMI devices:**

- Note that HDCP (High-bandwidth Digital Content Protection) support can delay the time taken for a TV to display content from a HDMI device.
- If the TV does not recognise the HDMI device and no picture is displayed, try switching the source from one device to another and back again.
- If there are intermittent sound disruptions, check that output settings from the HDMI device are correct.
- If you use an HDMI-to-DVI adapter or HDMI-to-DVI cable, check that an additional audio cable is connected to **AUDIO** (mini-jack only).

---

## Computer connection issues

**The computer display on the TV is not stable:**

- Check that your PC uses the supported resolution and refresh rate.
- Set the TV picture format to unscaled.

---

## Contact us

If you cannot resolve your problem, refer to the FAQs for this product at [www.philips.com/support](http://www.philips.com/support). If the problem remains unresolved, contact Philips Consumer Care in your country as listed in the Addendum.

**Warning**

- Do not attempt to repair the product yourself. This may cause severe injury, irreparable damage to your product or void your warranty.

**Note**

- Make a note of your TV model and serial number before you contact Philips. These numbers are printed on the back of the TV and on the packaging.

# 10 Index

---

<b>A</b>	
analogue	
fine-tune	28
antenna	31
<hr/>	
<b>B</b>	
batteries	38, 5
bracket for wall mount	39
<hr/>	
<b>C</b>	
CAM	35
care	5
channel decoder	26
channel grid	9
channels	
favourites list	16
fine-tune	28
grid	9
install	
automatic	27
manual	28
list	16
lock	20
rename	29
reorder / rearrange	29
switch	9
test reception (digital channels)	30
troubleshooting	40
tune	28
update	16
child lock	
lock channels	20
lock connected devices	20
PIN code	20
ratings lock	21
clock	
display	18
set	18
common interface	35
computer	
connect	41, 34
display resolution	38
Conditional Access Module	35
connect	
antenna	31
PC	41, 34
connectors	
HDMI	41, 31
overview	31
USB	22
content ratings	21
country	27
<hr/>	
<b>D</b>	
decoder	26
default settings	26
demo	26
devices	10
devices	
add to home menu	11
connect	31
remove	11
rename	11
watch	10
digital channel	
subtitles	22
test reception	30
digital radio	24, 27
digital services	
CAM	35
teletext	10, 15
disconnect USB	24
display	
resolution	38
dispose	5
<hr/>	
<b>E</b>	
EasyLink	
disable	36
enable	36
one-touch play	36
one-touch standby	36
system audio control	37
end of life	5
environmental care	5
e-sticker	25

<hr/>	
<b>F</b>	
factory settings	26
<b>favourites list</b>	
add to list	16
create list	16
view list	16
<b>fine-tune channels</b>	28
<hr/>	
<b>H</b>	
HDMI	41, 31, 32
hearing impaired	15
home mode	25
<hr/>	
<b>I</b>	
<b>install channels</b>	
automatic	27
manual	28
<hr/>	
<b>K</b>	
Kensington lock	37
<hr/>	
<b>L</b>	
<b>language</b>	
menu	27
subtitle	22
troubleshoot	40
<b>list</b>	
favourites list	16
<b>location</b>	
country	27
home or shop	25
<b>lock</b>	
Kensington lock	37
lock channels	20
lock connected devices	20
PIN code	20
ratings lock	21
<hr/>	
<b>M</b>	
<b>menu</b>	
language	27
main menu	11
teletext	15
universal access	15
<b>MHEG teletext</b>	10
<b>MPEG artifact reduction</b>	12
<b>multimedia</b>	38
<b>music</b>	
digital radio	24
USB	23
with slideshow	23
<b>mute TV speakers</b>	37
<hr/>	
<b>O</b>	
<b>OAD</b>	25
<b>on timer</b>	19
<b>one-touch play</b>	36
<b>one-touch standby</b>	36
<hr/>	
<b>P</b>	
<b>parental rating</b>	21
<b>PC</b>	
connect	34, 41
resolution	38
<b>picture format</b>	
change	13
troubleshooting	40
<b>picture settings</b>	12
<b>PIN code</b>	20
<b>pixel plus link</b>	25
<b>power</b>	38
<b>power consumption</b>	38
<b>preferences</b>	25
<b>product specifications</b>	38

---

<b>R</b>	
radio	24
rearrange channels	29
reception	30, 40
recycle	5
register product	7
<b>remote control</b>	
batteries	38, 5
overview	7
technical specifications	38
rename channels	29
reorder channels	29
resolution	38
restore default	26

---

<b>S</b>	
safety	4
screen care	5
<b>settings</b>	
picture	12
sound	14, 12
settings assistant	12
shop mode	25
<b>slideshow</b>	
view	23
with music	23
smart card	35
smart picture	12
smart settings	12, 14
smart sound	14
<b>software</b>	
over the air download	25
update	25
version	24
sound settings	14
specifications	38
standby	9
subpages in teletext	15
<b>subtitles</b>	
language	22
on analogue channel	21
on digital channel	22
<b>switch</b>	
channels	9
on and off	9
source	10

---

<b>T</b>	
Table of Pages	16
technical specifications	38
<b>teletext</b>	
features	15
menu	15
subpages	15
Table of Pages	16
use	10
<b>timer</b>	
on timer	19
sleep timer	19
standby	19
<b>transmission</b>	38, 40
<b>transporting</b>	4
<b>troubleshooting</b>	40
<b>TV lock</b>	
lock channels	20
lock connected devices	20
PIN code	20
ratings lock	21
<b>TV overview</b>	7

---

<b>U</b>	
universal access menu	15
<b>USB</b>	
disconnect USB	24
listen to music	23
update software	24
view photos	22

---

<b>V</b>	
<b>video format</b>	
technical specifications	38
<b>volume</b>	
adjust	10
automatic levelling	14
delta	14
mute	10, 37

---

<b>W</b>	
wall mount	4

# Information about how to re-tune your TV during the digital TV switchover.

**Keep this user manual safe – you'll need it.**

.....

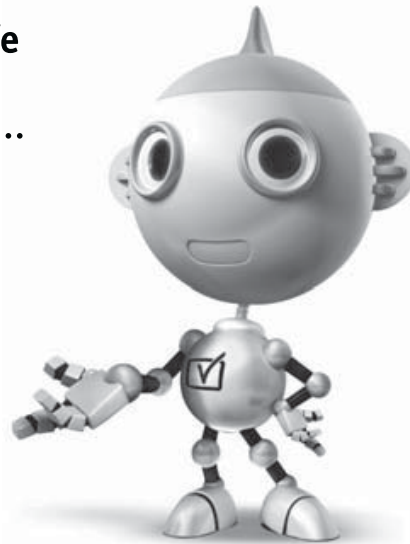

Television in the UK is going digital, bringing us all more choice and new services. Starting in late 2007 and ending in 2012, television services in the UK will go completely digital, TV region by TV region.

Please see the next page to find out when your area switches to digital.

Digital UK is the independent, non-profit organisation leading the process of digital TV switchover in the UK. Digital UK provides impartial information on what people need to do to prepare for the move to digital, and when they need to do it.

## **How the switchover affects your TV equipment:**

Your new TV has a digital tuner built in, which means it is ready to receive the Freeview signal by simply plugging it into your aerial socket (check if you can get digital TV through your aerial now, or whether you'll have to wait until switchover, at [www.digitaluk.co.uk](http://www.digitaluk.co.uk)).

When the TV switchover happens in your area, there are at least two occasions when you will need to re-tune your TV in order to continue receiving your existing TV channels, and also to pick up new ones.

**get set for digital** 

Digital UK, the body leading the digital TV switchover, will advise you when you need to re-tune during the switchover.

If you choose to connect your TV to satellite or cable with a digital box then it will not be affected by switchover, and you won't need to re-tune.

If you have any questions, please contact your equipment supplier or call Digital UK on ... 0845 6 50 50 50 or visit [www.digitaluk.co.uk](http://www.digitaluk.co.uk)

## How to re-tune:

To find out how to re-tune your TV, check this user manual for details.

Go to section **6 Install channels**.

If you do not re-tune your channels when advised to do so by Digital UK, you may lose some or all of your channels until you do re-tune. You should re-tune your TV every few months to check for any new channels.

If you are missing any channels, it may be that they are not available in your area, or that your aerial needs upgrading.

## When does switchover happen?

\*Copeland switches on October 17, 2007

The exact date you switch depends on the transmitter you are served by. To check when you switch, go to Digital UK's postcode checker on [www.digitaluk.co.uk](http://www.digitaluk.co.uk)

Check your ITV news service or look at Teletext page 106 to see what TV region you're in.

Visit us at [digitaluk.co.uk](http://digitaluk.co.uk)  
Call us on 0845 6 50 50 50†

† Calls charged at BT rate of 3p per minute daytime and 1p per minute evenings and weekends. Rates may vary for calls from non-BT lines.





## ГАРАНТИЙНЫЙ ТАЛОН НА ТЕЛЕВИЗОР

Модель:

Серийный номер:

Дата продажи:

**ПРОДАВЕЦ:**

Название торговой организации:

Телефон торговой организации:

Адрес и E-mail:

ПЕЧАТЬ  
ПРОДАВЦА

Изделие получил в исправном состоянии.  
С условиями гарантии ознакомлен и согласен.

---

*(подпись покупателя)*

**Внимание! Гарантийный талон недействителен без печати продавца.**

## Уважаемый потребитель!

Компания **Филипс** выражает благодарность за Ваш выбор и гарантирует высокое качество и безупречное функционирование Вашего телевизора при соблюдении правил его эксплуатации.

При покупке убедительно просим проверить правильность заполнения гарантийного талона. Серийный номер и наименование модели приобретенного Вами телевизора должны быть идентичны записи в гарантийном талоне. Не допускается внесения в талон каких-либо изменений, исправлений. В случае неправильного или неполного заполнения гарантийного талона немедленно обратитесь к продавцу.

Телевизор представляет собой технически сложный товар. При бережном и внимательном отношении он будет надежно служить Вам долгие годы. В ходе эксплуатации не допускайте механических повреждений, попадания внутрь посторонних предметов, жидкостей, насекомых, в течение всего срока службы следите за сохранностью идентификационной наклейки с обозначением наименования модели и серийного номера изделия.

Если в процессе эксплуатации изделия Вы сочтете, что параметры работы телевизора отличаются от изложенных в инструкции пользователя, рекомендуем обратиться за консультацией в наш Информационный центр.

### Условия гарантии

Объект	Телевизор	Пульт дистанционного управления
Срок гарантии	1 лет	1 год
Срок службы	5 год	1 год

Срок гарантии и срок службы исчисляется со дня передачи товара потребителю.

По окончании срока службы обратитесь в авторизованный сервисный центр для проведения профилактических работ и получения рекомендаций по дальнейшей эксплуатации изделия.

Во избежание возможных недоразумений, сохраняйте в течение срока службы документы, прилагаемые к товару при его продаже (данный гарантийный талон, товарный и кассовый чеки, накладные, данную инструкцию по эксплуатации и иные документы).

Гарантийное обслуживание не распространяется на изделия, недостатки которых возникли вследствие:

1. Нарушения потребителем правил эксплуатации, хранения или транспортировки товара
2. Действий третьих лиц:
  - ремонта неуполномоченными лицами;
  - внесения несанкционированных изготовителем конструктивных или схемотехнических изменений и изменений программного обеспечения
  - отклонение от Государственных Технических Стандартов (ГОСТов) и норм питающих, телекоммуникационных и кабельных сетей;
  - неправильной установки и подключения изделия;
3. Действия непреодолимой силы (стихия, пожар, молния и т.п.);

**Любую информацию о расположении сервисных центров и о сервисном обслуживании Вы можете получить в Информационном Центре**

**Телефон: (495) 961-1111, 8 800 200-0880 (бесплатный звонок по России).**

**Интернет: [www.philips.ru](http://www.philips.ru)**

