

26PF4311S  
32PF4311S

**FLAT TV™**



**PHILIPS**

Thank you for purchasing this television set.  
This handbook has been designed to help you install and operate your TV set.  
We strongly recommend that you read it thoroughly.

## Table of Contents

Safety Information.....	2
Preparation / Getting started.....	3
Television keys and connectors.....	4
Remote Control keys.....	5
Remote Control keys (DVD).....	6
Quick installation.....	6
Programme sort.....	7
Auto store.....	7
Manual store.....	8
Naming of channel.....	8
Picture and Sound settings.....	9
Using the Contrast+ and NR (Noise Reduction) features.....	10
Timer function.....	10
Using the PIP (Picture-in-Picture) feature.....	11
Screen Formats.....	12
Using the Smart Picture and Sound features.....	13
Using the Active Control feature.....	13
Teletext.....	14
Using the TV as PC monitor.....	15
Using the TV in HD (High Definition) Mode.....	16
Troubleshooting Tips.....	17
Glossary.....	18
Specifications.....	19
Reference table of Countries available for selection.....	19



### Recycling

The packaging of this product is intended to be recycled. Apply to the local authorities for correct disposal.



### Disposal of your old product

Your product is designed and manufactured with highly quality material and components, which can be recycled and reused. When this crossed-out wheeled bin symbol is attached to a product, it means the product is covered by the European Directive 2002/976/EC. Please inform yourself about the local separate collection system for electrical and electronic products.

Please act according to your local rules and do not dispose of your old products with your normal household waste. The correct disposal of your product will help prevent potential negative consequences for the environment and human health.

## Safety Information

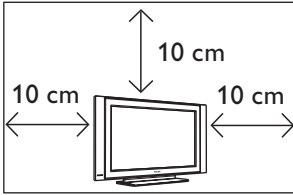

Leave at least 10 cm around each side of the TV set to allow for proper ventilation. Place the set on a stable, level surface. Never cover the ventilation slots of the TV with a cloth or other material. It may cause overheating. Do not insert anything in the ventilation holes. If metal or something flammable is inserted in these holes, it may result in fire or electric shock.



When cleaning the surface or the screen of the set, wipe gently with absorbent cotton or cloth or other soft material like chamois. Do not use too wet a cloth which is dripping with water. Do not use acetone, toluene or alcohol to clean the TV. As a safety precaution, unplug the power cord from the mains.

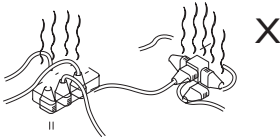

Take care not to connect too many equipment to the same mains socket as it may cause overloading resulting in fire or electric shock.

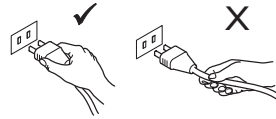

Pull the power lead by the plug. Do not pull on the power lead. Do not use a poor fitting mains socket. Insert the plug fully into the mains. If it is loose, it may cause arching and result in fire.

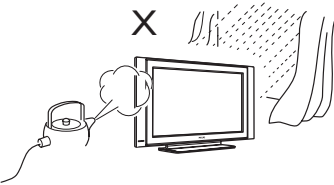

To prevent fire or shock hazard, do not expose your TV to rain or moisture.

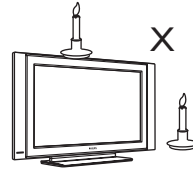

No naked flame sources (lighted candles) should be placed on the top of the set or near it.

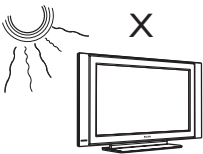

Avoid placing your TV set under direct sunlight or heat.

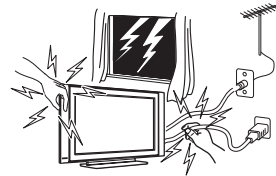

As a safety precaution, do not touch any part of the TV, power lead or aerial lead during lightning storms.

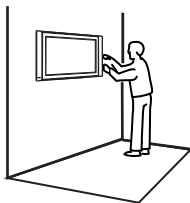

Installation of the TV set on the wall should be carried out by qualified serviceman. Improper and incorrect installation may render the set unsafe.



Avoid placing vase filled with water on the TV. Water spilled into the set could result in electric shock. Do not operate set if water is spilled into it. Have it checked immediately by a qualified serviceman.

# Preparation / Getting started

## 1 Positioning the TV set

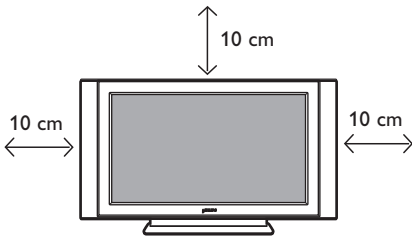

Place your TV set on a solid stable surface, leaving a space of at 10 cm around the set.

## 2 Connections

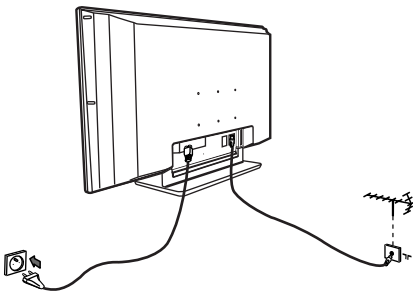

- Insert the aerial plug into the 75Ω socket at the bottom of the set.
- Insert the mains plug into a wall socket (220-240V / 50/60Hz).

### NOTE

For more details on other connections, see “CONNECTION GUIDE”.

## 3 Using the Remote Control

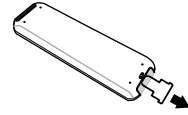

Pull out the plastic insulation sheet from the battery to enable the remote control to operate.

## 4 Switching on the TV set

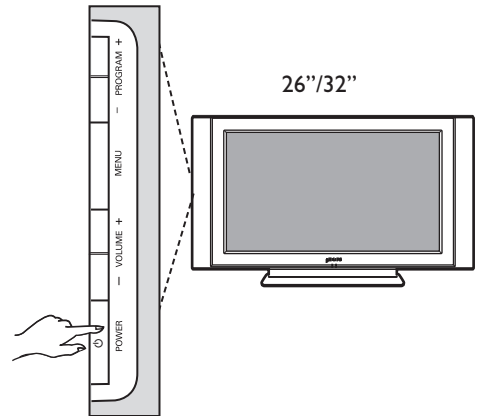

- To switch on the TV set, press the **POWER** button. A green indicator comes on and the screen lights up.
- If the TV set remains in standby mode (red indicator), press the **PROGRAM - / +** key on the keyboard or the **P - / +** key on the remote control.

# Television keys and connectors

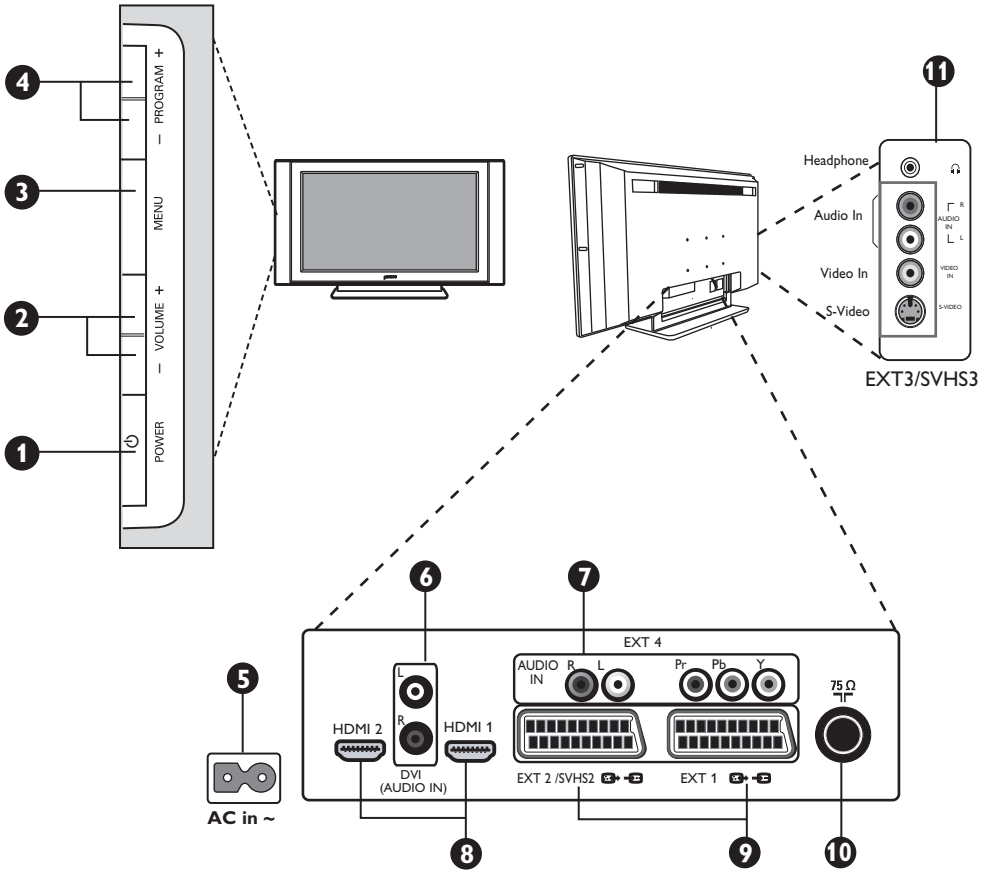

**1 POWER** : to switch the TV on and off.  
**Note** : The power remains on even when the Power switch is turned off.

**2 VOLUME +/-** : to adjust sound level.

**3 MENU** : to access or close menus.  
 The PROGRAM /CHANNEL +/- keys can be used to select a menu item and the VOLUME +/- keys to enter into the selected menu item and make adjustments.

**4 PROGRAM / CHANNEL +/-** : to select programmes.

**5 POWER** socket : Insert the mains plug into a wall socket.

**6 DVI Audio Input** : for connecting a HD (high definition) equipment or computer with DVI output.

**7 Component Video inputs / Audio Inputs** : to connect to equipment like DVD, Set-Top box which have the same sockets. Connect the audio inputs of the TV to the outputs of the device together with the Component Video Inputs.

**8 HDMI 1 /HDMI 2** sockets : to connect to set-top boxes, DVD player/recorder, High Definition equipment or Personal Computer.

**9 EXT1 and EXT2/SVHS2** sockets : connect to equipment like DVD player/recorder, VCR, Decoder which have scart connections.

**10 TV Aerial** socket : Insert the aerial plug into the 75  $\Omega$  socket .

**11 Side connections** : for connecting to devices like camera or camcorder. Also allows you to connect your headphone for your personal listening pleasure.

## NOTE

For more details on connections, see **CONNECTION GUIDE**.

## Remote Control keys

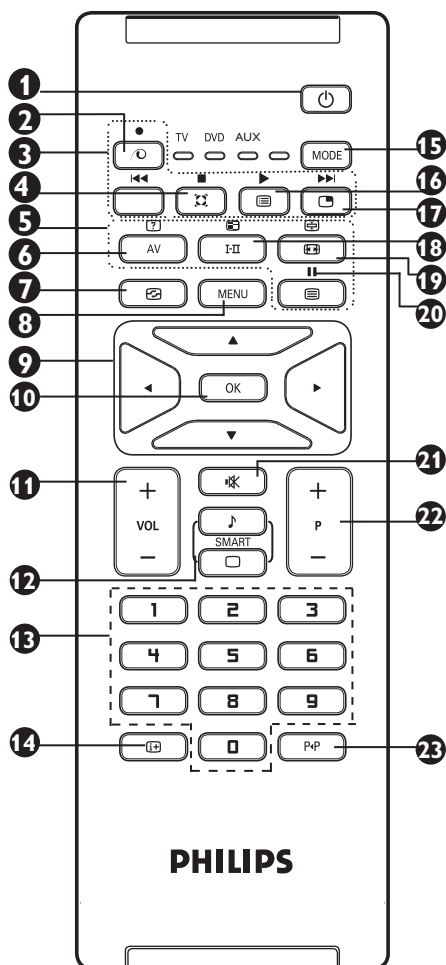

- 1 Standby** To set the TV to standby mode. To switch the TV set on again, press , to , P - / + or AV key.
- 2 Unused key in TV mode**
- 3 DVD / AUX** (see page 6).
- 4 Surround Sound** To activate / deactivate the surround sound effect. In stereo, this gives the impression that the speakers are further apart. For models equipped with Virtual Dolby Surround, you can experience Dolby Surround Pro Logic sound effects.
- 5 Teletext keys** (see page 14).
- 6 AV** To display Source List to select TV or peripheral equipment connected to EXT 1, EXT 2/SVHS2, EXT 3/SVHS3, EXT 4, HDMI 1 or HDMI 2.
- 7 Active Control** (See page 13).
- 8 MENU** To call up or exit the TV menus.
- 9 Cursors** These 4 keys are used for selection and adjustment of menu items.
- 10 OK** Confirms selection.
- 11 Volume (- VOL +)** To adjust the sound level.
- 12 Smart Picture /Sound** Used to access a series of predefined picture and sound settings (see page 13).
- 13 0 / 9 Numerical keys** / For direct access to programmes. For a 2 digit programme number, the 2<sup>nd</sup> digit must be entered before the dash disappears.
- 14 Screen information** To display/remove the programme number, the sound mode, the remaining time of the sleeptimer and the \*signal strength indicator. Press key for more than 5 seconds to display information permanently on screen and press key again for more than 5 seconds to remove information.
- 15 Mode** Select between TV, DVD and AUX mode (see "Remote Control - DVD or AUX on page 6).
- 16 Programme List** To display / clear the list of programmes. Use the keys to select a programme and the key to display it.
- 17 Picture-in-Picture** To display a PIP window on the TV screen (see page 10 on how to use the PIP feature).
- 18 Sound mode** Used to force programmes in **Stereo** and **Nicam Stereo** to **Mono** or, for bilingual programmes, to choose between **Dual I** or **Dual II**. The **Mono** indication is red when in forced position.
- 19 Screen Format** (see page 12).
- 20 DVD / AUX** (see page 6).
- 21 Mute** Press to mute or restore sound.
- 22 Selecting TV programmes (P - / +)** To select the next or previous programme. The number and the sound mode are displayed for a few seconds. For some TV programmes, the title of the programme appears at the bottom of the screen.
- 23 Previous/Present programme** To alternate between the last viewed and present programme.

\* The signal strength indicator shows the signal strength of the transmission of the programme you are watching.

## Remote Control keys (DVD or AUX)











The remote control also allows you to control the main functions of some Philips DVD models

**NOTE : Functions not available to Philips DVD-R device.**

Press the **MODE** key to select the required mode: **DVD** or **AUX**.

The remote control indicator lights up to display the selected mode. It switches off automatically after 20 seconds if left idle. The mode automatically returns to TV mode.

The following buttons are operational, depending on the equipment:

	standby		pause
	fast rewind		display and exit menu
	stop		programme selection
	play		navigation and adjustments, confirms selection
	fast forward		digit keys
	record		

## Quick Installation

**Plug & Play**

When you switch on the TV set for the first time, a menu is displayed on screen. This menu prompts you to select the country and language for the menus.

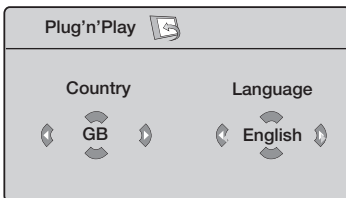

### Note

If the above menu is not displayed, proceed to do the installation of channels by the

**Auto Store** method (see page 7). If above menu is displayed, proceed to do the following steps.

- 1 Use the ▲ ▼ keys on the remote control to select your country. If your country does not appear in the list, select "...". Refer to the "Reference table of Countries available for selection" on page 19
- 2 Use the ► key to move to the Language mode and select your language by the ▲ ▼ keys.
- 3 Use the ► key to start search.

The search starts automatically. All the available TV programmes will be stored. This operation takes a few minutes. The display shows the progress of the search and the number of programmes found.

**Important :** To exit or interrupt the search before it is completed, press the **MENU** key. If you interrupt search during auto store, not all channels will be stored. For all channels to be stored, you need to do a complete auto store search again.

### Note

#### ATS (Automatic Tuning System) feature

If the transmitter or cable network sends the automatic sort signal, the programmes will be numbered correctly. In this case, the installation is complete. If this is not the case, you need to use the **Sort** menu to number the programmes correctly.

#### ACI (Automatic Channel Installation) feature

If a cable system or a TV channel which broadcasts ACI is detected, a programme list appears. Without ACI broadcast, the channels are numbered according to your language and country selection. You can use the **Sort** menu to renumber them.

Some transmitters or cable networks broadcast their own sort parameters (region, language, etc.). In this case, indicate your choice using the ▲ ▼ keys and confirm with ► key.

## Program Sort

- 1 Press the **MENU** key. The **TV Menu** is displayed on the screen.

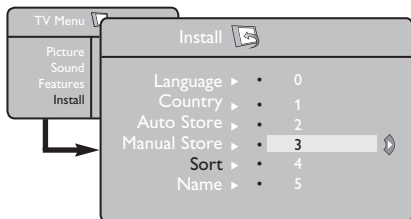

- 2 Use the **▼** key, select the **Install** menu and the **▶ / OK** key to enter the **Install** menu.

- 3 Use the **▼** key to select **Sort** and the **▶ / OK** key to enter sort mode.
- 4 Select the programme number you want to move using the **▲ ▼** keys and the **▶ / OK** key to enter sorting mode (The arrow cursor now points to the left).
- 5 Use the **▲ ▼** keys to select the new programme number and confirm with the **◀ / OK** key. (The arrow points to the right and sorting is completed).
- 6 Repeat steps 4 and 5 for each programme number you wish to re-number.
- 7 To return to previous menu, press the **MENU** key.
- 8 To exit the menu, press the **i+** key.

## Auto Store

- 1 Press the **MENU** key.
- 2 Using the **▼** key, select **Install** and the **▶ / OK** key to enter the **Install** menu (**Language** is highlighted).

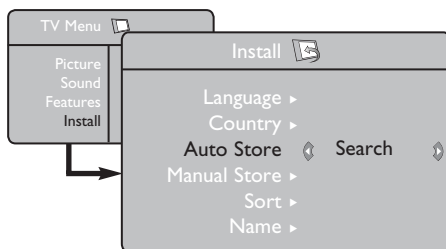

- 3 Before you proceed to do auto store of channels, select your desired menu \***Language** with the **◀ ▶** keys.

- 4 Select **Country** with the **▼** key and use the **◀ ▶** keys to select the country of your choice.
- 5 Using the **▼** key, select **Auto Store** and the **▶ / OK** key to start automatic searching of the channels. All the available TV programmes will be stored. This operation takes a few minutes. The display shows the progress of the search and the number of programmes found.
- 6 After the search is completed, press the **i+** key to exit menu.

**Important :** To exit or interrupt the search before it is completed, press the **i+** key. If you interrupt search during auto store, not all channels will be stored. For all channels to be stored, you need to do a complete auto store search again.

### \* Selecting the language

If you have selected the wrong language for one reason or another and do not understand the language to operate the set, do the following to bring you back to your preferred language :

- press the **i+** key to exit the existing menu.
- press the **MENU** key to enter the TV menu.

- press the **▼** key repeatedly until the **FOURTH** item in the TV menu is highlighted.
- press the **▶ / OK** key to go into the **Install** menu.
- press the **◀ ▶** keys to select your preferred language (the menu will now appear in the chosen language). You can proceed to install the TV channels automatically.



## Manual Store

This menu is used to store the programmes one at a time.

- 1 Press the **MENU** key.
- 2 With the **▼** key, select **Install** and the **► / OK** key to enter the **Install** menu.
- 3 Use the **▼** key to select **Manual Store** and the **► / OK** key to enter Manual Store menu.
- 4 Use the **▲ ▼** keys to select the items in the Manual Store menu to adjust or activate.

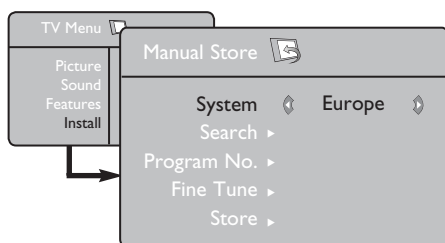

- 5 **System** : Use the **◀ ▶** keys to select **Europe** (automatic detection\*), **France** (LL' standard) or **UK** (I standard), **West Europe** (BG standard), **East Europe** (DK standard). or

\* Except for France (LL' standard), you must select **France**.

- 6 **Search** : Press the **► / OK** key. The search starts. Once a programme is found, the scanning stops and its name is displayed (if available). Go to the next step. If you know the frequency of the required programme, this can be entered directly using the **0** to **9** keys.

If no picture is found, see "Troubleshooting Tips" on page 17 and 18..

- 7 **Program No.** : Enter the required number with the **0** to **9** or **◀ ▶** keys.
- 8 **Fine Tune** : If the reception is not satisfactory, adjust using the **◀ ▶** keys.
- 9 **Store** : To store the changes, press **► / OK** key . The programme is now stored.
- 10 Repeat steps **6** to **9** for each programme to be stored.
- 11 To return to previous menu, press the **MENU** key.
- 12 To exit the menu, press the **i+** key.

## Naming of Channel

You can give a name to the TV channel.

Press the **MENU** key.

- 1 With the **▼** key, select **Install** and the **► / OK** key to enter the **Install** menu.

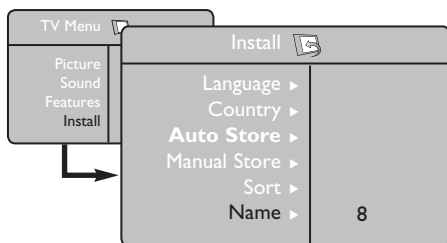

- 3 Use the **▼** key to select **Name** and the **► / OK** key to enter name mode.
- 4 Use the **▲ ▼** keys to select the programme you want to name and the **► / OK** key to enter naming mode.
- 5 Use the **▲ ▼** keys to select the characters and use the **◀ ▶** keys to move around the name display area (maximum of 5 characters).
- 6 Press **◀ ▶ / OK** key until the name appears at the top right hand corner of the TV screen. The name is now stored.
- 7 To exit the menu, press the **i+** key.

# Picture and Sound Settings

- 1 Press the **MENU** key.
- 2 Use the **▲ ▼** keys to select **Picture** or **Sound**.
- 3 Use the **◀ ▶** / **OK** keys to enter **Picture** or **Sound** menu.

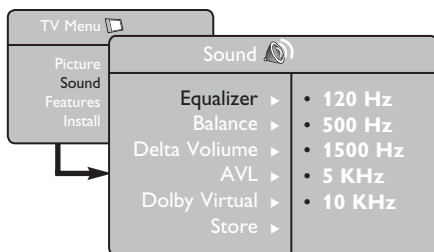
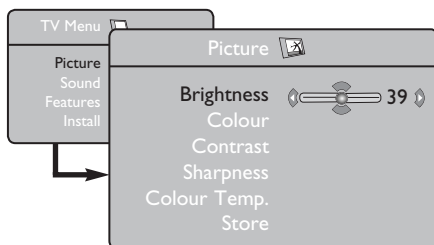

- 4 Use the **▲ ▼** keys to select a Picture or Sound setting and the **◀ ▶** keys to adjust.
- 5 To return to previous menu, press the **MENU** key.
- 6 To exit the menu, press the **EXIT** key.

## Description of the Picture settings

**Brightness** : this changes picture brilliance.

**Colour** : this changes the intensity of the colour.

**Contrast** : this changes the difference between the light and dark tones.

**Sharpness** : this increases or decreases the sharpness level to improve details in the picture.

**Colour Temp.** : this changes the colour rendering: Cool (bluer), Normal (balanced) or Warm (redder).

**Store** : to store the picture adjustments and settings.

## Description of the Sound settings

**Equalizer** : to adjust the sound tone (from bass: 120 Hz to treble : 10 KHz).

**Balance** : this balances the sound on the left and right speakers.

**Delta Volume** : this is used to compensate any volume differences between the different programmes or EXT sockets. **Note** : Programmes 0 to 40 have individual volume setting and programmes 41 and above share common setting.

**AVL (Automatic Volume Leveller)** : this is used to limit sudden increases in sound, especially on programme change or advertising slots.

**Dolby Virtual** : To activate / deactivate the surround sound effect.

You can also access these settings with the **EXIT** key.

**Store** : this is used to store the sound settings.

## Using the Contrast+ and NR (Noise Reduction) features

- 1 Press the **MENU** key.
- 2 With the **▼** key, select **Features** and the **▶ / OK** key to enter the **Features** menu.
- 3 Use the **▲ ▼** keys to select **Contrast+** or **NR (Noise Reduction)** and the **◀ ▶** keys to select an **On** or **Off** option.
- 4 To return to previous menu, press the **MENU** key.
- 5 To exit the menu, press the **EXIT** key.

### Definition of the feature settings

#### Contrast+ :

- optimise the total contrast of the picture for improved picture visibility.
- select **On** option to activate feature.

#### NR (Noise Reduction) :

- improves “noisy” picture (little dots on picture) due to weak signal transmission.
- select **On** option to activate feature.

## Timer function

This menu lets you use the TV set as an alarm.

- 1 Press the **MENU** key.
- 2 With the cursor, select the **Features** menu then **Timer** :
- 3 **Sleep**: to select an automatic standby period.

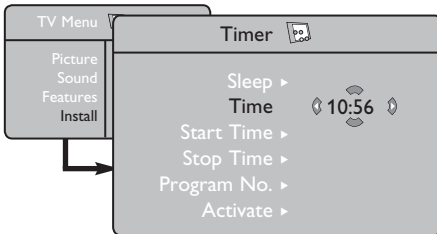

- 4 **Time**: enter the current time.

**Note:** the time is updated automatically each time the TV set is switched on via the teletext information on programme 1. If this programme does not have teletext, the update will not take place.

- 5 **Start Time**: enter the start time.

- 6 **Stop Time**: enter the standby time.

- 7 **Program No.:** enter the number of the programme for the wake-up alarm.

- 8 **Activate:** the settings include:

- **Once** for a single alarm,
- **Daily** for each day,
- **Off** to cancel.

- 9 Press **POWER** to put the TV set in standby. It will automatically come on at the time programmed.

If you leave the TV set on, it will just change programmes at the time entered (and will go to standby mode at the Stop Time).

## Using the PIP (Picture-in-Picture) feature

The **PIP** (Picture-in-Picture) feature allows you to call up a PIP screen of the **PC** (Personal Computer) or **HD** (High Definition) device while watching a TV programme.

### IMPORTANT

To call up a **PIP** screen of the **PC** equipment, the following step must be taken :

**HDMI 1** or **HDMI 2** input **MUST** be connected to the **DVI** output of the **PC** equipment. Use a **HDMI/DVI** cable to do the connection.

To call up a **PIP** screen of the **HD** equipment, the following steps must be taken :

**HDMI 1** or **HDMI 2** input **MUST** be connected to the **HDMI** output of the **HD** equipment.

### NOTE

- While you are watching TV programmes, you can only call up a PIP screen from only one source.
- Go to the PIP menu and select **HDMI**. See below on how to access the PIP menu.
- Select **HDMI 1** or **HDMI 2** depending on connection.

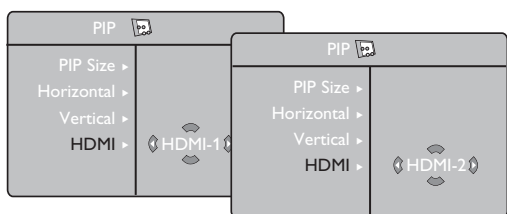

### Accessing the PIP screen via the PIP menu

**Note** : This is only possible when PIP signal is detected.

- 1 Press the **MENU** key to display main menu.
- 2 With the **▲ ▼** key, select **Features** and the **▶ / OK** key to enter the **Features** menu.

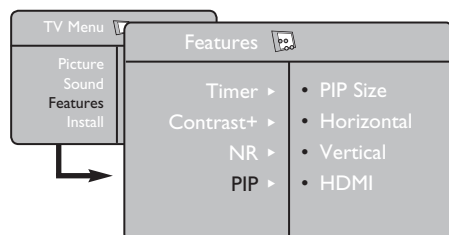

- 3 Use the **▲ ▼** keys to select **PIP**
- 4 Use the **▶ / OK** key to enter **PIP** menu.

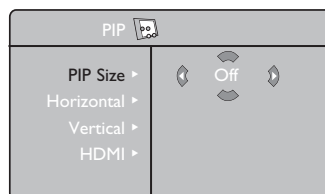

- 5 Use the **▲ ▼** keys to select **PIP** menu items.
- 6 Use the **◀ ▶ ▲ ▼** keys to access the **PIP** menu items, make the following adjustments or options.
- 6 To exit the PIP screen, select **PIP Size**, followed by the **Off** option.

### Definitions of PIP items

- PIP Size** : Select your PIP size (**Off, Small, Medium, Large** and **Side-by-Side**).
- Horizontal** : Move the PIP screen horizontally from left to right and vice-versa.
- Vertical** : Move the PIP screen vertically from top to bottom and vice-versa.
- HDMI** : If **HDMI 1** or **HDMI 2** are both connected, you can only select one source, **HDMI 1** or **HDMI 2**.

### Accessing the PIP screen via the PIP key

**Note** : This is only possible when PIP signal is detected.

- 1 Press the **PIP** key on the remote control to display PIP screen. A small PIP screen will appear on the TV screen.
- 2 Press the **PIP** key a second time to change the small PIP screen to a medium PIP screen size.
- 3 Press the **PIP** key a third time to change the medium PIP screen to large PIP screen size.
- 4 Press the **PIP** key a fourth time to change the large PIP screen to a Side-by-Side (a TV screen on one side and the PIP screen on the other side).
- 5 Press the **PIP** key a fifth time exit PIP screen.

### NOTE

**For more details on connections to the PC and HD equipment, see CONNECTION GUIDE.**

## Screen Formats

The pictures you receive may be transmitted in 16:9 format (wide screen) or 4:3 format (conventional screen). 4:3 pictures sometimes have a black band at the left and right of the screen. This function allows you to optimise the picture display on screen.

Press the  key (or ◀ ▶) to select the different modes. This TV set is also equipped with automatic turning which will select the correct-screen format, provided the specific signals are transmitted with the programmes.

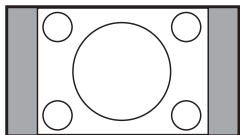

### 4:3

The picture is reproduced in 4:3 format and a black band is displayed on either side of the picture.

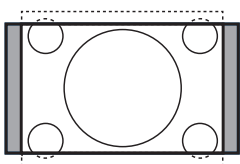

### Movie expand 14:9

The picture is enlarged to 14:9 format, a thin black band remains on both sides of the picture.

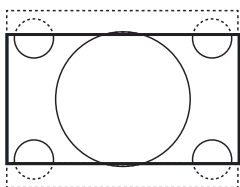

### Movie expand 16:9

The picture is enlarged to 16:9 format. This mode is recommended when displaying pictures which have black bands at the top and bottom (letterbox format).

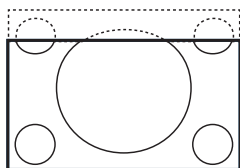

### Subtitle Zoom

This mode is used to display 4:3 pictures using the full surface of the screen leaving the sub-titles visible.

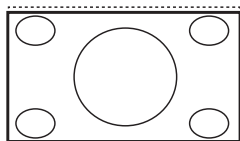

### Superzoom

This mode is used to display 4:3 pictures using the full surface of the screen by enlarging the sides of the picture.

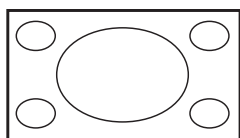

### Widescreen

The picture is displayed in the correct proportions of images transmitted in 16:9.

*Note: If you display a 4:3 picture in this mode, it will be enlarged horizontally.*

## Using the Smart Picture and Sound features

**Smart Picture** feature offers you a choice of 5 picture settings namely : **Rich**, **Natural**, **Soft**, **Multimedia** and **Personal**.

Press the  button repeatedly to cycle through the settings to select your desired mode.

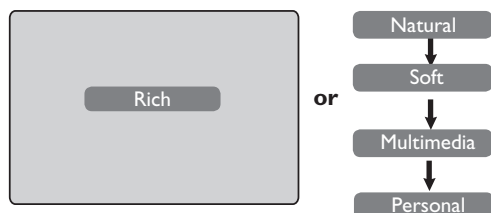

### Definition of Picture Settings

- Rich** : Brilliant and sharp picture settings suitable for bright environment and for use in demonstrations to show off the quality of the TV on good sources.
- Natural** : Reference mode for living room conditions and average signals.
- Soft** : Intended for bad-quality signals. Suitable for living room viewing.
- Multimedia** : Best for graphical applications.
- Personal** : Pictures settings are set to your preference.

**Smart Sound** feature offers you a choice of 4 sound settings namely : **Theatre**, **Music**, **Voice**, and **Personal**.

Press the  button repeatedly to cycle through the settings to select your desired mode.

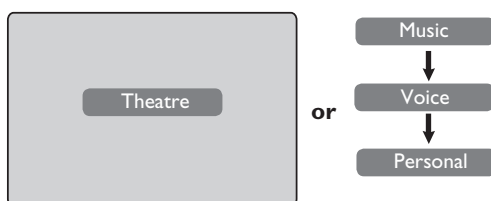

### Definition of Sound Settings

- Theatre** : Emphasize sensation to action (Bass and Treble boosted).
- Music** : Emphasize low tone (Bass boosted).
- Voice** : Emphasize high tone (Treble boosted).
- Personal** : Sound settings are set to your preference.

**NOTE** : The **Personal** setting is the setting that you set up using the Picture/Sound menu in the main menu. This is the only setting in the Smart Picture/Sound settings that can be changed. All other settings are pre-set at the factory.

## Using the Active Control feature

**Active Control** feature automatically adjusts the picture setting for optimal picture quality continuously under any signal conditions.

- 1 Press the  key repeatedly to toggle between **Active Control Off** and **Active Control On** options.

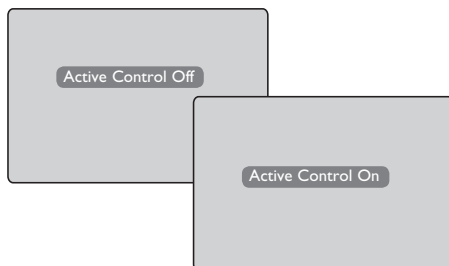

- 2 Select the **Active Control On** option to activate the Active Control feature.
- 3 Select the **Active Control Off** option to deactivate the Active Control feature.

# Teletext

Teletext is an information system broadcast by certain channels which can be consulted like a newspaper. It also offers access to subtitles for viewers with hearing problems or who are not familiar with the transmission language (cable networks, satellite channels, etc.).

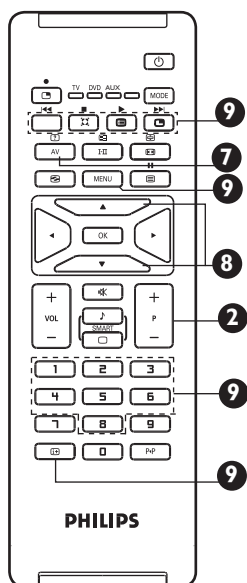
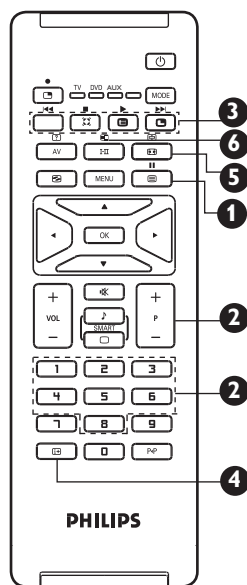

## 1 Teletext call



This is used to switch on or off teletext display. The summary appears with a list of items that can be accessed. Each item has a corresponding 3 digit page number. If channel selected does not broadcast teletext, the indication 100 will be displayed and the screen will remain blank. Proceed to exit teletext and select another channel.

## 2 Selecting a page



Enter the number of the page required using the 0 to 9 keys or P +/- keys. Example: page 120, enter 120. The number is displayed at the top left corner of the screen. When the page is located, the counter stops searching. Repeat this operation to view another page. If the counter continues to search, this means that the page is not transmitted. Select another number.

## 3 Direct access to the items



Coloured areas are displayed at the bottom of the screen. The 4 colour keys are used to access the items or corresponding pages. The coloured areas flash when the item or the page is not yet available.

## 4 Contents



This returns you to the contents page (usually page 100).

## 5 Sub-page display



Certain pages contain sub-pages which are automatically displayed successively. Press the sub-page key to hold sub-page and press the key a second time to resume. Use the left/right arrow keys to select previous or next sub-page.

## 6 Double page teletext



To activate or deactivate the double page teletext display mode. The active page is displayed on the left and the following page is displayed on the right. Press the double page key if you want to hold a page (i.e. the contents page). The active page is then displayed on the right. To return to normal mode, press the I-II key.

## 7 Hidden information



To display or hide the concealed information (games solutions).

## 8 Enlarge a page



This allows you to display the top or bottom part of the page. Pressing it again will return the page to normal size.

## 9 Favourite pages

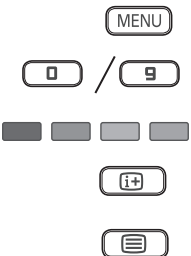

Instead of the standard coloured areas displayed at the bottom of the screen, you can store 4 favourite pages on the first 40 channels which can then be accessed using the coloured keys (red, green, yellow, blue). Once set, these favourite pages will become the default every time teletext is selected.

1. Press the MENU key to change to favourite pages mode.
2. Use the 0 / 9 keys to enter the teletext page that you want to store as a favourite page.
3. Press and hold the colour key of your choice for about 5 seconds. The page is now stored.
4. Repeat steps 2 to 3 with the other coloured keys.
5. To exit favourite page mode, press the MENU key.
6. To exit teletext mode, press the sub-page key.

**NOTE** : To clear favourite pages, press and hold the i+ key for about 5 seconds.

# Using the TV as a PC Monitor

Your TV can be used as a computer monitor.

## IMPORTANT

For the TV to function as PC monitor, the following steps must be taken :

- 1 **HDMI 1** or **HDMI 2** input **MUST** be connected to the DVI output of the PC. Use a DVI to HDMI adaptor to do the connection.
- 2 Press the **AV** key to display **Source List** and use the **▲ ▼** key to select **HDMI 1** or **HDMI 2**.
- 3 Use the **▶ / OK** key to switch to the selected source.

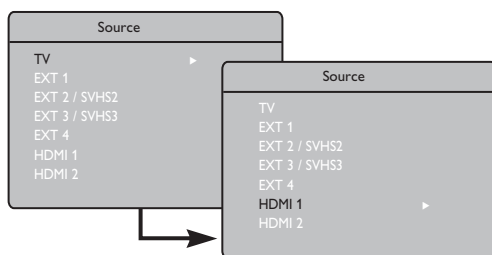

## Using the PC menus

- 1 Press the **MENU** key to display the PC menu.
- 2 Use the **▲ ▼** key to access the settings and the **◀ ▶ / OK** key to select or adjust setting (the settings are automatically saved).

## Description Picture settings

### Brightness / Contrast :

– Adjusts the brightness and contrast.

### Colour Temp :

– Changes the colour rendering : **Cool** (bluer), **Normal** (balance) or **Warm** (redder).

### Audio Selection :

– Chooses the audio from the TV or PC/HD.

## NOTE

For more details on connection to the PC equipment, see **CONNECTION GUIDE**.

## Description of Features

### Format :

– Chooses between full screen or native format of the PC screen.

### PIP (Picture-in Picture) :

– Displays a PIP screen to watch TV programmes at the same time.

## Using the PIP feature

The **PIP** (Picture-in-Picture) feature allows you to call up a PIP screen of a TV programme while you are in **PC** mode.

## IMPORTANT

To call up a **PIP** screen of the **TV** programme, the following step must be taken :

**HDMI 1** or **HDMI 2** input **MUST** be connected to the **DVI** output of the **PC** equipment. Use a **HDMI** to **DVI** adaptor cable to do the connection.

The PIP menu items : **PIP Size**, **Horizontal** and **Vertical** works in exactly the same way as when calling a PIP screen in TV mode. Except for **HDMI**, there is no selection for other source.

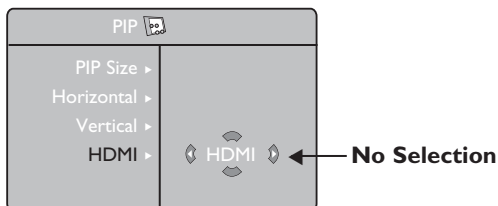

For description of PIP menu items and how it works, refer to the section on “Using the PIP (Picture-in Picture) Feature” page 11.

## Supported PC Resolutions

640 x 480, 60 Hz	1024 x 768, 60 Hz
640 x 480, 67 Hz	1024 x 768, 70 Hz
640 x 480, 72 Hz	1024 x 768, 75 Hz
640 x 480, 75 Hz	
800 x 600, 56 Hz	
800 x 600, 60 Hz	
800 x 600, 72 Hz	
800 x 600, 75 Hz	



# Using the TV in HD (High Definition) Mode

## HD Mode

The HD (High Definition) mode allows you to enjoy clearer and sharper pictures if you are using a HD equipment that can transmit high definition programming.

### IMPORTANT

For the TV to function in HD mode, the following steps must be taken :

- 1 **HDMI 1** or **HDMI 2** input **MUST** be connected to the HDMI/DVI output of the HD equipment . Use a HDMI to DVI adaptor if DVI is connected. **For more information, refer to Connection Guide.**
- 2 Press the **AV** key to display **Source List** and use the **▲ ▼** key to select **HDMI 1** or **HDMI 2**.
- 3 Use the **▶ / (OK)** key to switch to the selected source.

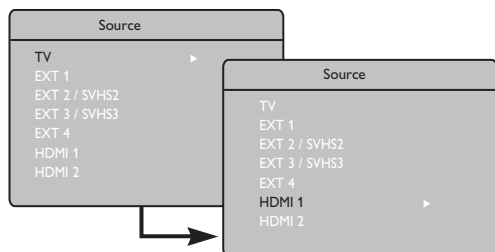

## Using the HD menus

- 1 Press the **(MENU)** key to display the HD menu.
- 2 Use the **▲ ▼** key to access the settings and the **◀ ▶** key to select or adjust setting.

### HD Install menu

**Note :** You cannot access **Install** in the HD menu There is **NO Install** function in HD mode.

### HD Picture and Sound settings

Functions of HD Picture and Sound settings are the same as the TV Picture and Sound settings and work in exactly the same way as the TV Picture and Sound settings (see page 9).

Your Philips TV is HDMI compliant. If you do not get a good picture, please change the video format on your device (DVD player, cable set-top box, etc.) to a standard format. For example, for DVD player, select 480p, 576p, 720p or 1080i. For PC, select 640 x 480, 800 x 600 or 1024 x 768. If the problem persists, please refer to your PC user manual on possible software upgrades to your graphics card.

**Please note that this is not a defect of the TV set.**

## HD Features

**Timer :** Functions of the Sleptimer and Timer are the same as the TV Sleptimer and Timer functions and work in exactly the same way as the TV Sleptimer and Timer functions (see page 10).

**PIP :** Display a PIP screen to watch TV programmes at the same time. The PIP menu items : **PIP Size**, **Horizontal** and **Vertical** work in exactly the same way as when calling a PIP screen in TV mode.

For description of PIP menu items and how it works, refer to the section on “Using the PIP (Picture-in Picture) Feature” page 11.

\* **Horizontal Shift :** Adjust the horizontal position of the image.

\* **Mode Selection :** When you connect PC or HD equipment supporting resolutions of **480p**, **576p** or **720p**, the **Mode Selection** in the **Features** menu will be highlighted. This will allow you to select between the PC and HD mode. If it does not support the 480p, 576p or 720p resolutions, you cannot access this function.

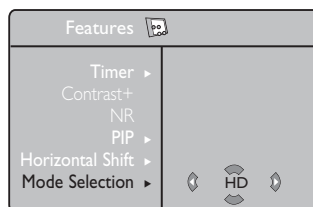













### Supported HD format

480p	576p	720p	1080i
------	------	------	-------

**NOTE :** For more details on connection to the HD equipment, see **CONNECTION GUIDE**.

## Troubleshooting Tips

Below is a list of symptoms you may encounter with your TV. Before you call for service, make these simple checks.

Symptom	Possible Causes	What you should do
<b>No display on screen</b>	<ul style="list-style-type: none"> <li>Faulty power supply</li> <li>TV's Power not turned</li> </ul>	<ul style="list-style-type: none"> <li>Check whether power cord is properly connected into the mains socket and to your TV. If there is still no power, on disconnect plug. Wait for 60 seconds and re-insert plug. Switch on TV again.</li> <li>Press the  key on the remote control.</li> </ul>
<b>Poor reception (snowish picture and noise)</b>	<ul style="list-style-type: none"> <li>Faulty antenna connection</li> <li>Weak transmission</li> <li>Wrong TV system</li> </ul>	<ul style="list-style-type: none"> <li>Check antenna connection at rear of TV.</li> <li>Try manually adjusting your picture (refer to page 8).</li> <li>Have you chosen the right TV system? (refer to page 8).</li> </ul>
<b>No picture</b>	<ul style="list-style-type: none"> <li>Faulty aerial and cable</li> <li>Wrong source selected</li> </ul>	<ul style="list-style-type: none"> <li>Check whether euroconnector cables or aerial sockets are properly connected.</li> <li>Check whether the source is correctly selected. Press  button to enter Source list and select the correct source.</li> </ul>
<b>No sound on certain channels</b>	<ul style="list-style-type: none"> <li>Wrong TV system</li> </ul>	<ul style="list-style-type: none"> <li>Check whether the correct TV system is selected (refer to page 8).</li> </ul>
<b>No sound</b>	<ul style="list-style-type: none"> <li>Zero volume level</li> <li>Sound muted</li> <li>Headphone is connected</li> </ul>	<ul style="list-style-type: none"> <li>Try increasing volume.</li> <li>Check that the mute ( ) mode is not on. If mute mode is on, press the  key to deactivate mute mode.</li> <li>Aim remote control directly at sensor on front of TV.</li> <li>Disconnect headphone connection.</li> </ul>
<b>Sound interference</b>	<ul style="list-style-type: none"> <li>Electrical appliances interference</li> </ul>	<ul style="list-style-type: none"> <li>Try switching off any electrical appliances, for example, hairdryer, vacuum cleaner that are in use.</li> </ul>
<b>Unable to understand the language on screen to operate set</b>	<ul style="list-style-type: none"> <li>Wrong language selected accidentally</li> </ul>	<ul style="list-style-type: none"> <li>Press the  key to exit menu from screen. Press the  key to enter main menu. Use the  key to select the <b>fourth</b> item on the main menu. Use  /  key to enter into the next menu level and the   key to select correct language.</li> </ul>
<b>TV not responding to remote control</b>	<ul style="list-style-type: none"> <li>Wrong placement of batteries</li> <li>Flat batteries</li> </ul>	<ul style="list-style-type: none"> <li>Check the placement of the batteries.</li> <li>Try changing the batteries.</li> </ul>
<b>Occasional appearance of red, blue, green and black spots on screen</b>	<ul style="list-style-type: none"> <li>Characteristic of liquid crystal panel</li> </ul>	<ul style="list-style-type: none"> <li>This symptom is not a problem. The liquid crystal panel is built with very high precision technology giving you the fine picture details. Occasionally, a few non-active pixels may appear on the screen as a fixed point of red, blue, green or black. Note that this does not affect the performance of the set.</li> </ul>
<b>Intermittent or flickering picture on in HD mode</b>	<ul style="list-style-type: none"> <li>* HDCP (see glossary) authentication failed</li> </ul>	<ul style="list-style-type: none"> <li>Noise is displayed if the connected digital equipment's (DVD player or Set-Top box) *HDCP authentication failed. Check user manual for the digital equipment you are connecting.</li> <li>Use a standard HDMI to DVI cable.</li> </ul>
<b>No sound or picture but front panel red light is on</b>	<ul style="list-style-type: none"> <li>Set on standby mode</li> </ul>	<ul style="list-style-type: none"> <li>Press the  key on the remote control.</li> </ul>

## Troubleshooting Tips

Symptom	Possible Causes	What you should do
<b>Cannot access Install menu</b>	<ul style="list-style-type: none"> <li>In AV, EXTERNAL or HD mode</li> </ul>	<ul style="list-style-type: none"> <li>Press AV key and select TV mode. You can now access the Install menu by using the Menu key.</li> </ul>
<b>PC modes do not work</b>	<ul style="list-style-type: none"> <li>Wrong connections</li> <li>Wrong source selected.</li> <li>Wrong display resolution</li> <li>Wrong setting of PC graphic card</li> </ul>	<ul style="list-style-type: none"> <li>Check whether connections are correct. (see "Using your TV as PC Monitor" on page 15). (For more details on connection to the PC equipment, see "Connection Guide".</li> <li>Check whether the source is correctly selected. Press <b>AV</b> button to enter Source list and select the correct source.</li> <li>Check whether you have configured the computer on a compatible display resolution (see "Using your TV as PC Monitor" on page 15).</li> <li>Check graphic card setting of PC.</li> </ul>
<b>S-Video colour becomes faint</b>	<ul style="list-style-type: none"> <li>Wrong detection of signal</li> </ul>	<ul style="list-style-type: none"> <li>Check whether power cord is properly connected</li> <li>Press the <b>P +</b> key on the remote control to do a channel up and then press the <b>P -</b> key to do a channel down.</li> </ul>
<b>Black bar on top and bottom of screen in PC mode</b>	<ul style="list-style-type: none"> <li>PC refresh rate too high</li> </ul>	<ul style="list-style-type: none"> <li>Change PC refresh rate to 60 Hz.</li> </ul>

## Glossary

**DVI** (Digital Visual Interface) : A digital interface standard created by the Digital Display Working Group (DDWG) to convert analog signals into digital signals to accommodate both analog and digital monitors.

**VGA** (Video Graphics Array) : a common standard graphics display system for PCs.

**RGB signals** : These are the three video signals, Red Green Blue, which make up the picture. Using these signals improves picture quality.

**S-VHS signals** : These are 2 separate Y/C video signals from the S-VHS and Hi-8 recording standards. The luminance signals Y (black and white) and chrominance signals C (colour) are recorded separately on the tape. This provides better picture quality than with standard video (VHS and 8 mm) where the Y/C signals are combined to provide only one video signal.

**NICAM sound** : Process by which digital sound can be transmitted.

**16:9** : Refers to the ratio between the length and height of the screen. Wide screen televisions have a ratio of 16/9, conventional screen TV sets have a ratio of 4/3.

**HDMI** (High-Definition Multimedia Interface) : Provides an uncompressed, all digital audio/video interface between the TV and any HDMI-equipped audio/video component, such as set-top box, DVD player and A/V receiver. HDMI supports enhanced or high-definition video plus two-channel digital audio.

**System** : Television pictures are not broadcast in the same way in all countries. There are different standards: BG, DK, I, and LL'. The System setting (p. 8) is used to select these different standards. This is not to be confused with PAL or SECAM colour coding. PAL is used in most countries in Europe, SECAM in France, Russia and most African countries. The United States and Japan use a different system called NTSC.

**HDCP** (High-bandwidth Digital-Content Protection): HDCP encrypts the transmission of digital content between the video source or transmitter such as a computer, DVD player or set-top box and the digital display or receiver such as a monitor, television or projector.

## Specifications

	26"	32"
Panel screen size	660 mm (26")	800 mm (32")
Audio output	2 x 5 W	2 x 15 W
TV System	PAL, SECAM	
Video playback	NTSC, PAL, SECAM	
Sound System	Mono, Nicam Stereo, Virtual Dolby Surround	
Connectivity Rear  Side	Antenna In 75 $\Omega$ , Scart 1, Scart 2, HDMI 1, HDMI 2, Component Video Input, DVI Audio In Audio In, Video In, S-Video In, Headphone	
Power consumption	110 W	120 W
Standby power consumption	< 1 W	< 1 W
Set dimensions (with stand) Width Depth Height	805 mm 222 mm 477 mm	924 mm 222 mm 550 mm
Nett Weight (with stand)	13.3 kg	19 kg

### Reference table of Countries available for selection

Abbreviation	Country	Abbreviation	Country	Abbreviation	Country
A	Austria	GR	Greece	H	Hungary
B	Belgium	I	Italy	HR	Croatia
CH	Switzerland	IRL	Ireland	PL	Poland
D	Germany	L	Luxembourg	RO	Romania
DK	Denmark	N	Norway	RUS	Russia
E	Spain	NL	Netherlands	SK	Slovakia
F	France	P	Portugal	SLO	Slovenia
FI	Finland	S	Sweden	TR	Turkey
GB	England	CZ	Czech Republic	- - -	Others



Specifications are subject to change without notice.  
Trademarks are the property of Koninklijke Philips Electronics N.V. or their respective owners.  
2005 © Koninklijke Philips Electronics N.V. All rights reserved.

[www.philips.com](http://www.philips.com)

