

FLAT TV

User Manual

32PFL7332

32PFL7932

42PFL7432

52PFL7432

English

中文

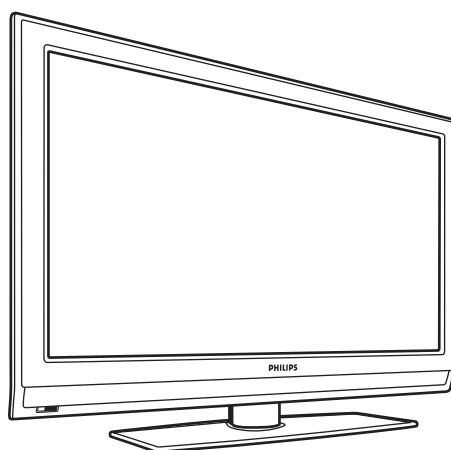

PHILIPS





Recycling

The packaging of this product is intended to be recycled. Apply to the local authorities for correct disposal.



Disposal of your old product

Your product is designed and manufactured with highly quality material and components, which can be recycled and reused. When this crossed-out wheeled bin symbol is attached to a product, it means the product is covered by the European Directive 2002/96/EC.

Please inform yourself about the local separate collection system for electrical and electronic products. Please act according to your local rules and do not dispose your old products with your normal household waste. The correct disposal of your old product will help prevent potential negative consequences for the environment and human health.

Disposal of batteries

The batteries supplied do not contain the heavy metals mercury and cadmium. Please check on how to dispose exhausted batteries according to local regulations.

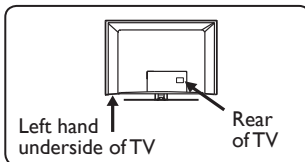

- The Model and Serial number can be found at the rear and the left hand underside of your television set and on the packaging.
- This TV consumes minimal energy in standby mode to minimise environmental impact.

- Power Consumption of the set can found on the type plate at the rear of the TV.
- For more specifications of the product see the product leaflet on www.philips.com/support.

Note

Specifications and information are subject to change without notice.

- If you need further assistance, please call the customer support service in your country. The corresponding telephone numbers and addresses are given in the supplied Worldwide guarantee booklet.

Important

- Some TV antennas require power from the TV set. This set does not support such a feature.

Electric, Magnetic and Electromagnetic Fields (“EMF”)

- Royal Philips manufactures and sells many products targeted at consumers, which, like any electronic apparatus, in general have the ability to emit and receive electromagnetic signals.
- One of Philips’ leading Business Principles is to take all necessary health and safety measures for our products, to comply with all applicable legal requirements and to stay well within the EMF standards applicable at the time of producing the products.
- Philips is committed to develop, produce and market products that cause no adverse health effects.
- Philips confirms that if its products are handled properly for their intended use, they are safe to use according to scientific evidence available today.
- Philips plays an active role in the development of international EMF and safety standards, enabling Philips to anticipate further developments in standardization for early integration in its products.

Safety

General

- Two people are required to lift and carry a TV that weighs more than 25 kg. Improper handling of the TV can cause serious injury.
- The surface on which the TV is placed has to be level and able to withstand its weight.
- Air must be able to circulate freely through the ventilation slots. Do not place the TV in a confined place.
- Do not place naked flame sources such as lighted candles close to the TV.
- Do not place a vase filled with water near the TV. Spills can result in electric shock. If water gets into the TV, disconnect the TV from the mains and have it checked by a qualified technician.
- Do not expose the TV or the batteries of the remote control to heat, direct sunlight, rain or water.
- During a thunderstorm, do not touch any part of the TV, power cord or antenna cable.
- Do not leave the TV in standby mode for an extended period of time. Instead disconnect it from the mains.
- Do not connect too many equipment to the same mains socket because it can result in fire or electric shock.

Wall mounting the TV

- To wall mount the TV, please consult a qualified technician. Improper mounting of the TV can cause serious injury.
- Please check that the structure of the wall is suitable to carry the weight of the TV.
- Before mounting, all cables must be inserted into the connectors of the TV. connections can be done later.
- Wherever you place or hang the TV, ensure that air can circulate freely through the ventilation slots. Do not position the TV in a confined space.

Caring and cleaning of the TV

- Do not remove the protective sheet until you have completed the stand/wall mounting and connections.
- Use only the soft cloth provided to clean the glossy area of the TV. For the other parts of the TV, use a soft dry cloth. Disconnect the TV from the mains before you clean the TV.
- Do not touch, push, rub or strike the screen with anything hard as this may scratch or damage the screen permanently.

Contents

Getting started	1
Connecting the antenna.....	1
Connecting / disconnecting from the mains.....	1
Installing batteries into the remote control	2
Switching on the TV	2
Controls and connectors	3
Side controls.....	3
Side connectors	3
Rear connectors	4
Remote control keys and functions	5
Selecting the menu languages	7
Searching and storing channels	8
Automatic searching	8
Manual Searching	9
Selecting Colour or Sound System.....	9
Searching for your channels	10
Fine Tuning your channels	11
Sorting your channels	12
Naming your channels	13
Storing your favorite channels	14
Adjusting your picture settings	15
Adjusting your sound settings	16
Setting the timer	17
Setting the sleep timer	17
Setting the clock	18
Displaying the clock permanently	18
Setting the time to switch channels	19
Setting the time to switch TV to standby.....	20
Setting ways to activate the timer	20
Locking and unlocking the TV side control	21
Activating the Child Lock.....	21
Deactivating the Child Lock.....	21
Controlling TV program access	22
Accessing Parental Lock.....	22
Changing the access code.....	23
Locking all channels.....	24
Unlocking all channels	24

Contents

Switching on and off Active Control	25
Switching on Active Control	25
Switching off Active Control	25
Ambilight	26
Switching on Ambilight	26
Switching off Ambilight	26
Settings for Ambilight.....	27
Adjusting brightness	27
Selecting Ambilight modes	27
Selecting Ambilight colour	28
Using custom colours	29
Selecting Ambilight balance.....	29
Displaying Demo mode	30
Displaying Demo mode.....	30
Accessing Teletext.....	30
Switching on/off Teletext.....	30
Selecting a page.....	30
Fastext (only applicable when Fastext is in broadcast).....	30
Selecting index (contents) page.....	30
Selecting subpage directly.....	30
Enlarging a page.....	30
Page hold	30
Hidden information.....	30
Selecting picture formats.....	31
Selecting Smart picture and Smart sound settings.....	32
Smart sound settings	32
Smart picture settings.....	32
Using the TV as a computer monitor	33
Setting the picture, sound and features in VGA mode	33
Using the TV in High Definition (HD) mode.....	34
Connecting the HD equipment.....	34
Controlling the TV settings while in HD mode.....	34
Mode Selection in Features menu	35
Display (native 1080) in Features menu	35
Connecting to other devices.....	37
Troubleshooting.....	38
Symptom.....	38
Possible solutions	38
Specifications.....	40

Getting started

NOTE: If you intend to mount the TV on the wall, all cables must be inserted into the connectors of the TV first.

Connecting the antenna

The antenna socket is located at the rear panel (underside) of the TV.

- 1 Insert the antenna connector into the TV antenna socket.
- 2 Insert the connector at the other end of the cable into your wall antenna socket.

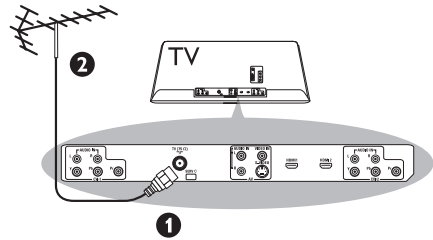

Connecting / disconnecting from the mains

- 1 Insert the power cord connector (appliance coupler) into the socket located at the rear (underside) of the TV.
- 2 Insert the plug into the wall power socket.

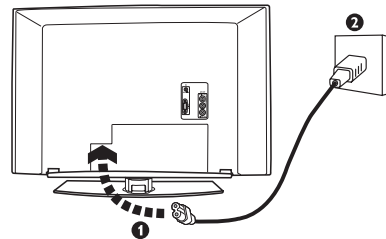

NOTE:

The appliance coupler of the power cord on the TV is used as the disconnect device. Ensure that the power cord is fully inserted into the TV mains socket and the wall socket. To disconnect from the mains, remove the power cord from the TV mains socket or the wall socket. Verify that the mains supply voltage in your home corresponds to the voltage information printed on the sticker at the rear of the TV.

WARNING:

For TV mounted on a swivel base or arm, please ensure that the power cord is not strained during swivelling. Straining the power cord will loosen connections. This may cause arcing and result in fire.

Getting started

Installing batteries into the remote control

- ❶ Remove the cover at the back of the remote control.
- ❷ Insert the two supplied batteries with the (+) and (-) ends lined up correctly.

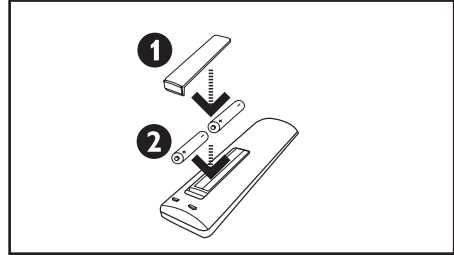

Switching on the TV

The TV controls are located at the left side of the set.

- ❶ Press the **POWER** button. A blue indicator light comes on.
- ❷ Press **CHANNEL + / -** to change the channels.
- ❸ If the TV is in standby mode (red indicator lights up), press the **CHANNEL + / -** to switch on the TV.

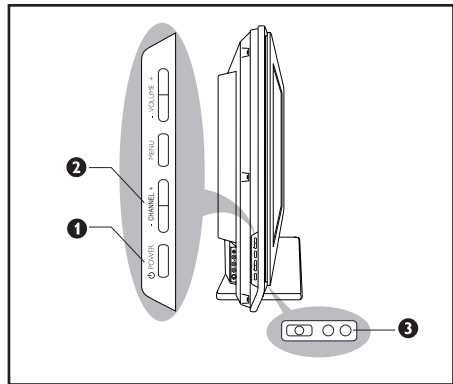

Controls and connectors

Side controls

The side controls are on the left side of the TV set.

1 VOLUME + / -

To increase volume level, press VOLUME +, to decrease level, press VOLUME -.

2 MENU

To display the on-screen menus or to exit from the on-screen menus.

The CHANNEL + / - buttons can be used to navigate the menu items.

The **VOLUME + / -** buttons can be used to select the menu items.

3 CHANNEL + / -

To select the TV channel numbers upwards or downwards.

4 POWER

To turn off or turn on the TV set.

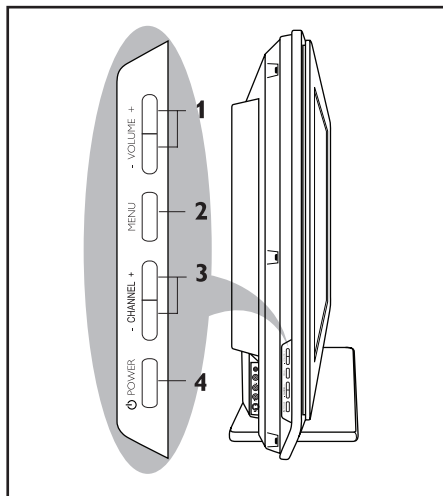

Side connectors

The side connectors are on the left side of the TV set.

1 Headphones

To connect to your headphones.

2 Audio / Video / S-Video

To connect your devices such as camera or player.

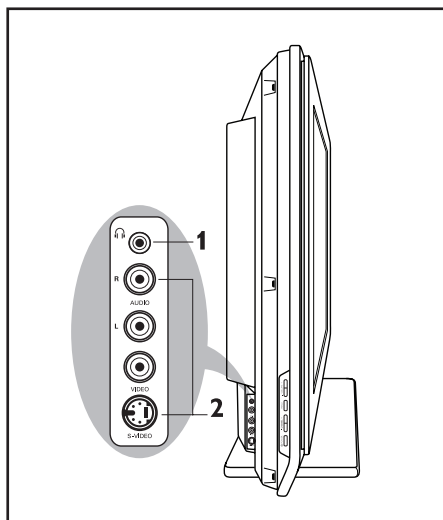

Controls and connectors

Rear connectors

The rear connectors are at the back (underside) of the TV set.

1 CVI-1 / CVI-2

To connect to your devices such as DVD players, decoders and Home Theatre systems.

2 Antenna

To connect to the antenna.

3 Audio / Video / S-Video

To connect your devices such as camera, camcorder, or video player.

4 HDMI1 / HDMI2

To connect your devices such as set-top box, DVD player/recorder, high definition equipment or personal computer.

5 VGA / Audio for PC

To use the TV as a computer monitor. You can view the computer's content in the TV's different screen sizes and listen to the audio content.

6 Audio / Video

To connect your devices such as Home Theater systems and DVD recorders.

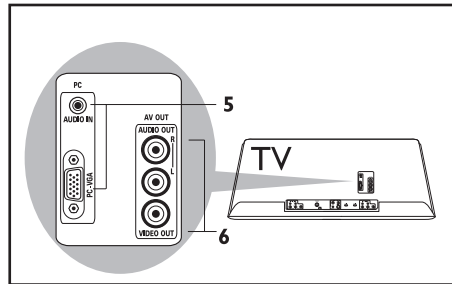
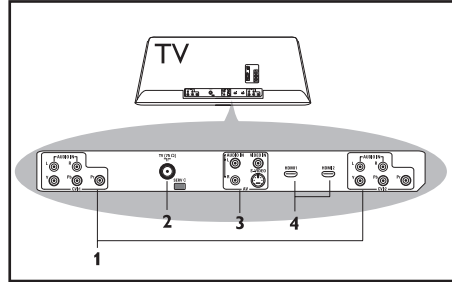

Remote control keys and functions

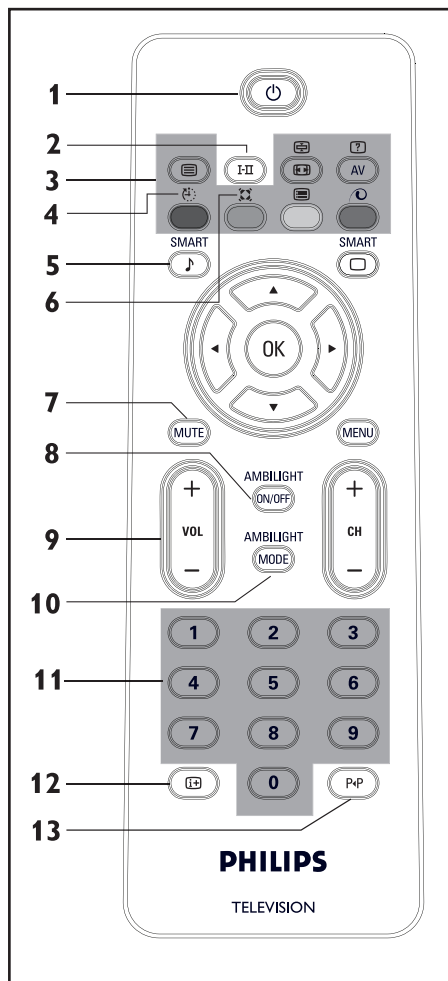

- 1 Standby button**
To switch the TV to standby mode if it is already turned on. Or to turn on TV when it is in standby mode.
- 2 I-II button**
To select Stereo and forced Mono sound effect.
- 3 Teletext ***
*Not applicable for models sold in China (see page 30)
- 4 Sleep timer**
To switch off TV to standby at a specified time (see page 17).
- 5 Smart Sound button**
To select the pre-set Sound settings.
- 6 Incredible Surround button**
To enable Incredible Surround in stereo mode and Spatial in mono mode.
- 7 Mute button**
To turn off or turn on sound.
- 8 Ambilight On/Off button**
To switch on or off Ambilight.
- 9 Volume buttons**
To turn up or turn down the sound level.
- 10 Ambilight mode button**
To select the Ambilight mode set in Features menu.
- 11 Number (0-9) buttons**
To enter channel number, set time or timer.
- 12 On screen information button**
To display information on the current channel or to exit on-screen menus.
- 13 Alternate Channel button**
To display the last viewed channel.

Remote control keys and functions

14 Picture Format button

To cycle through list of available picture formats.

15 AV button

To display AV source list or to cycle through list of AV sources by pressing the button repeatedly.

16 Pixel Plus Demo button

To turn on Pixel Plus Demo. One half of screen will display image with Pixel Plus enabled and the other half without.

17 Smart Picture button

To select the pre-set picture settings.

18 Program List button

To display the list of available channels which you can scroll through using the cursor buttons.

19 Cursor buttons

To navigating and selecting menu items and adjusting individual settings.

20 OK button

To select menu items or confirm selection.

21 Menu button

To display the on-screen menus and exit menus from the screen.

22 Channel buttons

To select the higher or lower channel number.

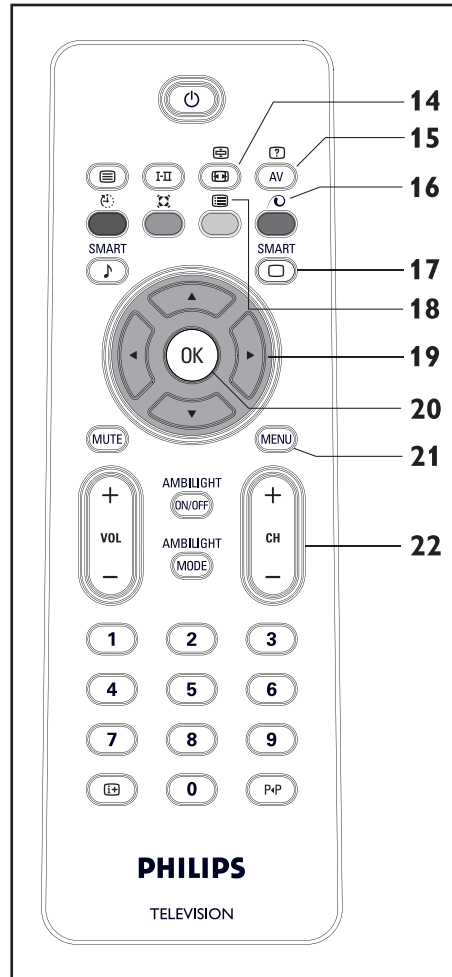

NOTE:

The **OK** button is used to select menu items or confirm your selection.

You can also press the **▶** button instead of the **OK** button. Either of the button will work in the same context.

Selecting the menu languages

Before using the on-screen menus, select your menu language.

1 Press **MENU** button to display the on-screen menus.

2 Press **▼** button until **Install** is highlighted.

3 Press **OK** button to select **Language**.
The available languages for your TV will be displayed on the right panel.

4 Press **OK** button to highlight the first language or **▼** to select the other available languages.

5 Press **OK** button to select the language.

6 Press **MENU** button to exit the on-screen menus.

PHILIPS	
Main	
Picture	Brightness
Sound	Colour
Features	Contrast
Install	Sharpness
	Colour Temp
	Contrast +
	NR

PHILIPS	
Main	
Picture	Language
Sound	Auto Store
Features	Manual Store
Install	Sort
	Name
	Fav. Program

PHILIPS	
Install	
Language	English
Auto Store	Chinese
Manual Store	Arabic
Sort	Thai
Name	Vietnamese
Fav. Program	

PHILIPS	
Install	
Language	English
Auto Store	Chinese
Manual Store	Arabic
Sort	Thai
Name	Vietnamese
Fav. Program	

Searching and storing channels

When you are using the TV for the first time, it is recommended that you run the automatic or manual searching of channels.

Automatic searching

- 1 Press **MENU** button to display the on-screen menus.
- 2 Press **▼** button until **Install** is highlighted.
- 3 Press **OK** button to select **Install**.
- 4 Press **▼** button until **Auto Store** is highlighted.
- 5 Press **OK** button to start **Auto Store**.
The TV will start scanning for channels automatically. When it finds a channel, it will assign the channel number 1 to it and continue scanning for the next available channel. When scanning has completed, the progress bar display will exit from the screen. The first channel found will be displayed on the screen.
- 6 Press **MENU** button to exit the on-screen menus.

TIP:

To cancel or interrupt auto searching, press the **MENU** button. Only channels that were found before interruption, will be stored.

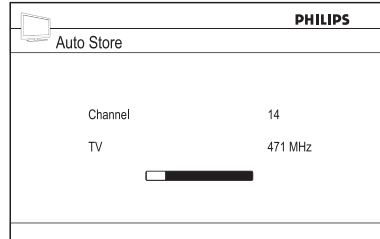
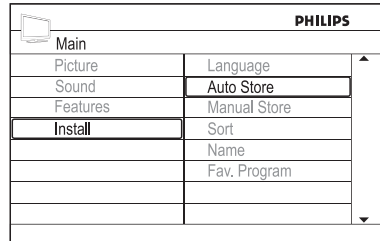
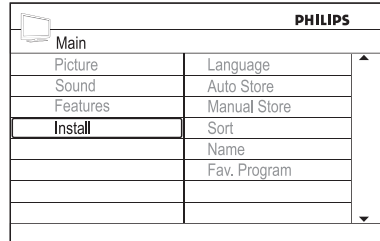

Searching and storing channels

Manual Searching

In manual searching, you can select the following items to tune for channels:

Colour System

Sound System















Search

Channel

Fine Tune

Store (To store your settings)

Selecting Colour or Sound System

- 1 Press  button to display the on-screen menus.
- 2 Press  button to highlight **Install** and then press the  button to select it.
- 3 Press  button to highlight **Manual Store** and then press the  button to select it.
- 4 Press  button to highlight **Colour System** or **Sound System** and then press the  button to select it.
- 5 Press  or  button to select the type of system and press the  button.
- 6 Press  button to exit and then press  button to highlight **Store**.
- 7 Press the  button to select it and then press the  button to store the settings.
- 8 Press  button to exit the on-screen menus.

PHILIPS	
Main	
Picture	Language
Sound	Auto Store
Features	Manual Store
Install	Sort
	Name
	Fav. Program

PHILIPS	
Install	
Language	Colour System
Auto Store	Sound System
Manual Store	Search
Sort	Channel
Name	Fine Tune
Fav. Program	Store

PHILIPS	
Manual Store	
Colour System	Auto
Sound System	PAL
Search	NTSC 3.58
Channel	SECAM
Fine Tune	
Store	

PHILIPS	
Manual Store	
Colour System	Auto
Sound System	M
Search	BG
Channel	I
Fine Tune	DK
Store	

PHILIPS	
Manual Store	
Colour System	Yes
Sound System	Stored
Search	
Channel	
Fine Tune	
Store	

Searching and storing channels

Searching for your channels

You can search for channels manually by using the **Search** feature.

- 1 Press **MENU** button to display the on-screen menus.
- 2 Press **▼** button to highlight **Install** and then press the **▶** button to select it.
- 3 Press **▼** button to highlight **Manual Store** and then press the **▶** button to select it.
- 4 Press **▼** button to highlight **Search** and then press the **▶** button to select it.
- 5 Press the **▶** button again to start scanning for the next available channel **or** key in the frequency directly. Next you will need to assign a channel number to this channel.
- 6 Press **▼** button to highlight **Channel** and then press the **▶** button to enter your assigned channel number.
- 7 Press **◀** button to exit and then press **▼** button to highlight **Store**.
- 8 Press the **▶** button to select it and then press the **OK** button to store the settings.
- 9 Press **MENU** button to exit the on-screen.

PHILIPS	
Main	
Picture	Language
Sound	Auto Store
Features	Manual Store
Install	Sort
	Name
	Fav. Program

PHILIPS	
Install	
Language	Colour System
Auto Store	Sound System
Manual Store	Search
Sort	Channel
Name	Fine Tune
Fav. Program	Store

PHILIPS	
Install	
Colour System	44 MHz
Sound System	
Search	
Channel	
Fine Tune	
Store	

PHILIPS	
Install	
Colour System	0
Sound System	
Search	
Channel	
Fine Tune	

PHILIPS	
Manual Store	
Colour System	Yes
Sound System	Stored
Search	
Channel	
Fine Tune	
Store	

Searching and storing channels

Fine Tuning your channels

You can fine tune the channels after you have searched them automatically by using the **Fine Tune** feature. Switch to the channel number that you want to fine tune.

- 1 Press **MENU** button to display the on-screen menus.
- 2 Press **▼** button to highlight **Install** and then press the **▶** button to select it.
- 3 Press **▼** button to highlight **Manual Store** and then press the **▶** button to select it.
- 4 Press **▼** button to highlight **Fine Tune** and then press the **▶** button to select it.
- 5 Press **▲** or **▼** button to adjust the slider on the tuning bar until you get the best reception.
- 6 Press **◀** button to exit and then press **▼** button to highlight **Store**.
- 7 Press the **▶** button to select it and then press the **OK** button to store the settings.
- 8 Press **MENU** button to exit the on-screen.

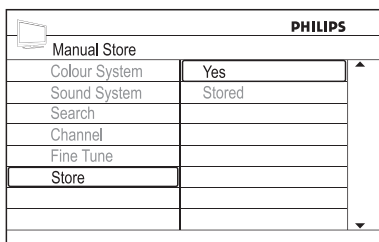
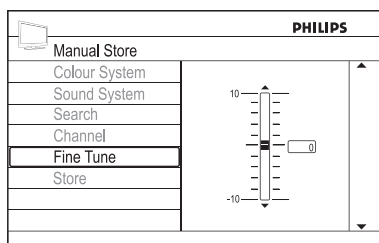
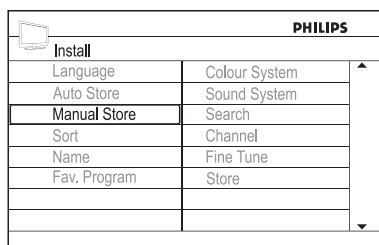
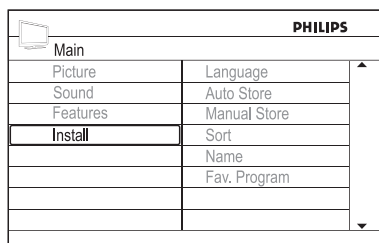

Sorting your channels

You can rearrange the numbers assigned to the channels previously.

- 1 Press **MENU** button to display the on-screen menus.
- 2 Press **▼** button to highlight **Install**.
- 3 Press **OK** button to select **Install**.
- 4 Press **▼** button to highlight **Sort**.
- 5 Press **OK** button to select **Sort**.
- 6 Press **▼** button to highlight the channel number you want to rearrange from.
- 7 Press **▶** button to confirm.
- 8 Press **▲** or **▼** button to highlight the new channel number you want to change to.
- 9 Press **◀** button to confirm.

Repeat steps 6 to 9 to rearrange more channels, otherwise proceed to step 10.

- 10 Press **MENU** button to exit the on-screen menus.

PHILIPS	
Main	
Picture	Language
Sound	Auto Store
Features	Manual Store
Install	Sort
	Name
	Fav. Program

PHILIPS	
Install	
Language	002
Auto Store	003
Manual Store	004
Sort	005
Name	006
Fav. Program	007
	008
	009

PHILIPS	
Install	
Language	002
Auto Store	003
Manual Store	004
Sort	005
Name	006
Fav. Program	007
	008
	009

PHILIPS	
Install	
Language	002
Auto Store	003
Manual Store	004
Sort	005
Name	006
Fav. Program	007
	008
	009

Naming your channels

You can assign a short name for your channels with the **Name** feature.

- 1 Press **MENU** button to display the on-screen menus.
- 2 Press **▼** button to highlight **Install**.
- 3 Press **OK** button to select **Install**.
- 4 Press **▼** button to highlight **Name**.
- 5 Press **OK** button to select **Name**.
- 6 Press **▼** button to highlight the channel number you want to name.
- 7 Press **▶** button to start the process.
- 8 Press **▲** or **▼** button to cycle through the list (A-Z, 0-9) to select the characters or numbers to use for the channel name. You can use up to a combination of 5 characters or numbers for naming your channels.
- 9 Press **◀** button to end the process.

Repeat steps 6 to 9 to name more channels, otherwise proceed to step 10.

- 10 Press **MENU** button to exit the on-screen menus.

PHILIPS	
Main	
Picture	Language
Sound	Auto Store
Features	Manual Store
Install	Sort
	Name
	Fav. Program

PHILIPS	
Install	
Language	002
Auto Store	003
Manual Store	004
Sort	005
Name	006
Fav. Program	007
	008
	009

PHILIPS	
Install	
Language	002
Auto Store	003
Manual Store	004
Sort	005
Name	006
Fav. Program	007
	008
	009

PHILIPS	
Install	
Language	002 DOCU
Auto Store	003 NEWS
Manual Store	004 MOVIE
Sort	005 SPOR
Name	006 006
Fav. Program	007 007
	008 008
	009 009

Storing your favorite channels

The **Favorite Program** feature lets you store only the channels you want on your favorite list which you can access using the Channel +/- buttons.

1 Press **MENU** button to display the on-screen menus.

2 Press **▼** button to highlight **Install**.

3 Press **OK** button to select **Install**.

4 Press **▼** button to highlight **Fav. Program**.

The list of channel numbers are displayed on the right panel. All channel numbers will have a ✓ symbol beside them to indicate as favorite channel by default.

5 Press **▼** button to highlight a channel number you want to remove or add to the favourite list.

6 Press **OK** button to remove the channel (no ✓ symbol) or add the channel (with ✓ symbol) to the favourite list.

Channels in the favourite list can be call up with the Channel +/- button while those not in the list can be call up with the number buttons.

7 Press **MENU** button to exit the on-screen menus

PHILIPS	
Main	
Picture	Language
Sound	Auto Store
Features	Manual Store
Install	Sort
	Name
	Fav. Program

PHILIPS	
Install	
Language	002 ✓
Auto Store	003 ✓
Manual Store	004 ✓
Sort	005 ✓
Name	006 ✓
Fav. Program	007 ✓
	008 ✓
	009 ✓

PHILIPS	
Install	
Language	002 ✓
Auto Store	003 ✓
Manual Store	004
Sort	005 ✓
Name	006 ✓
Fav. Program	007 ✓
	008 ✓
	009 ✓

Adjusting your picture settings

The items on the **Picture** menu features lets you adjust various picture settings.

1 Press **MENU** button to display the on-screen menus.

The **Picture** sub-menu is highlighted by default.

2 Press **OK** button to select **Picture** menu.

3 Press **▲** or **▼** button to highlight the items you want to adjust.

4 Press **OK** button to select the item.

Picture settings:

- **Brightness:** Adjust the brightness of the picture.
- **Colour:** Adjust the intensity of the colors.
- **Contrast:** Adjust how light or dark the picture tones should be.
- **Sharpness:** Adjust the detail level of the picture.
- **Color Temp:** Set the color to Cool (more blue), Normal (balanced) or Warm (more red).
- **Contrast +:** Increases the contrast range of the TV. Select **On** to activate feature.
- **Noise Reduction (NR):** Improves “noisy” picture (little dots on picture) due to weak signal transmission. Select **On** to activate feature.

Depending on which **Picture** item you are adjusting, some items will have the level indicator bar, some with settings such as Cool, Warm and Normal or On and Off.

5 Press **▲** or **▼** button to adjust the settings.

6 Press **MENU** button to exit the on-screen menus.

PHILIPS	
Main	
Picture	Brightness
Sound	Colour
Features	Contrast
Install	Sharpness
	Colour Temp
	Contrast +
	NR

PHILIPS	
Picture	
Brightness	100
Colour	53
Contrast	
Sharpness	
Colour Temp	
Contrast +	
NR	

PHILIPS	
Picture	
Brightness	Cool
Colour	Normal
Contrast	Warm
Sharpness	
Colour Temp	
Contrast +	
NR	

PHILIPS	
Picture	
Brightness	Off
Colour	On
Contrast	
Sharpness	
Colour Temp	
Contrast +	
NR	

Adjusting your sound settings

The items on the **Sound** menu features lets you adjust various picture settings.

- 1 Press **MENU** button to display the on-screen menus.
- 2 Press **▼** button to highlight **Sound** menu.
- 3 Press **OK** button to select the **Sound** menu.
- 4 Press **▲** or **▼** button to highlight the items you want to adjust.
- 5 Press **OK** button to select the item.

Sound settings:

Equalizer – Adjusts each individual frequency (tone).

Balance – Balances the left and right speaker's sound level.

AVL (Automatic Volume Leveler) – Controls the sudden sound level increase when changing channels or during commercial break.

Incr. Surround – Enhances stereo effect.

Select **Incredible Surround** or **Stereo** (when in stereo mode) or **Mono** or **Spatial** (when in mono mode).

Depending on which **Sound** item you are adjusting, some items will have the level indicator bar, some with settings such as Mono and Spatial, or On and Off.

- 6 Press **▲** or **▼** button to adjust the settings.
- 7 Press **MENU** button to exit the on-screen menus.

PHILIPS	
Main	
Picture	Equalizer
Sound	Balance
Features	AVL
Install	Incr. Surround

PHILIPS	
Equalizer	
120 HZ	
200 HZ	
500 HZ	
1200 HZ	
3 KHZ	
7500 HZ	
12 KHZ	

PHILIPS	
Sound	
Equalizer	Off
Balance	On
AVL	
Incr. Surround	

PHILIPS	
Sound	
Equalizer	Mono
Balance	Spatial
AVL	
Incr. Surround	

NOTE:

Stereo and **Incredible Surround** modes can only be selected when the TV broadcast is in stereo. You can also press the **Ⓢ** button to toggle the sound modes.

Setting the timer

The **TIMER** sets the sleep timer, time to switch channel.

Setting the sleep timer

- 1 Press **MENU** button to display the on-screen menus.
- 2 Press **▼** button to highlight **Features** menu.
- 3 Press **OK** button to select **Features** menu.
- 4 Press **OK** button to select **Timer**.
- 5 Press **OK** button to select **Sleep**.

The right panel will display the sleep timer settings: Off, 15, 30, 45, 60, 90, 120, 180 and 240 minutes.

Depending on which **Sound** item you are adjusting, some items will have the level indicator bar; some with settings such as Mono and Spatial, or On and Off.

- 6 Press **▲** or **▼** button to the time before the TV switches to standby mode.
- 7 Press **OK** button to confirm the setting.
- 8 Press **MENU** button to exit the on-screen menu.

PHILIPS	
Main	
Picture	Timer
Sound	Child Lock
Features	Parental Lock
Install	Active Control
	Ambilight

PHILIPS	
Features	
Timer	Sleep
Child Lock	Time
Parental Lock	Start Time
Pixel Plus	Stop Time
Ambilight	Channel
	Activate
	Display

PHILIPS	
Timer	
Sleep	Off
Time	15
Start Time	30
Stop Time	45
Channel	60
Activate	90
Display	120
	180

TIP:

You can check if the sleep timer is enabled or the remaining time by pressing the **i+** button on the remote control. The status will be displayed on the bottom of the screen. To cancel sleep timer, select **Off** in the **Sleep** sub-menu.

Setting the timer

Setting the clock

Repeat steps **1** to **4** from the previous section “Setting the sleep timer” to access the “Time” menu.

5 Press **▼** button to highlight **Time**.

6 Press **(OK)** button to select **Time** menu. The entry fields --:-- will be displayed for you to enter the time in HH:MM format.

7 Press the number buttons (0-9) to enter the time. Example: 10:45.

8 Press **(MENU)** button to exit the on-screen menus.

PHILIPS	
Features	
Timer	Sleep
Child Lock	Time
Parental Lock	Start Time
Pixel Plus	Stop Time
Ambilight	Channel
	Activate
	Display

PHILIPS	
Timer	
Sleep	10:45
Time	
Start Time	
Stop Time	
Channel	
Activate	
Display	

Displaying the clock permanently

Repeat steps **1** to **4** from the previous section “Setting the sleep timer” to access the “Time” menu.

5 Press **(OK)** button to select **Display**.

6 Press **▲** or **▼** button to select **On**.

7 Press **(MENU)** button to exit the on-screen menus.

PHILIPS	
Timer	
Sleep	Off
Time	On
Start Time	
Stop Time	
Channel	
Activate	
Display	

TIP:

Press **(i+)** button on the remote control to see the time.

Setting the timer

Setting the time to switch channels

Repeat steps ① to ④ from the previous section “Setting the sleep timer” to access the “Time” menu.

⑤ Press ▼ button to highlight **Start Time**.

⑥ Press (OK) button to select **Start Time**. The entry fields --:-- will be displayed for you to enter the time in HH:MM format. This is the time when the TV will switch over automatically to the channels number you will set in later steps.

⑦ Press the number buttons (0-9) to enter the time. Example: 20:00.

⑧ Press ◀ button to return to the **Timer** menu.

⑨ Press ▼ button to highlight **Channel**.

⑩ Press (OK) button to select **Channel**.

⑪ Press the number buttons (0-9) to enter a channel number. Example: The TV will switch over to this channel at the “Start Time” that was set earlier on.

⑫ Press (MENU) button to exit the on-screen menus.

PHILIPS	
Features	
Timer	Sleep
Child Lock	Time
Parental Lock	Start Time
Pixel Plus	Stop Time
Ambilight	Channel
	Activate
	Display

PHILIPS	
Timer	
Sleep	20:00
Time	
Start Time	
Stop Time	
Channel	
Activate	
Display	

PHILIPS	
Timer	
Sleep	2
Time	
Start Time	
Stop Time	
Channel	
Activate	
Display	

Setting the timer

Setting the time to switch TV to standby

Repeat steps **1** to **4** from the previous section “Setting the sleep timer” to access the “Time” menu.

8 Press **▼** button to highlight **Stop Time**.

6 Press **(OK)** button to select **Stop Time**. The entry fields --:-- will be displayed for you to enter the time in HH:MM format. This is the time when the TV will switch over automatically to standby.

7 Press **(MENU)** button to exit the on-screen menus.

PHILIPS	
Timer	
Sleep	21:40
Time	
Start Time	
Stop Time	
Channel	
Activate	
Display	

Setting ways to activate the timer

Repeat steps **1** to **4** from the previous section “Setting the sleep timer” to access the “Time” menu.

8 Press **▼** button to highlight **Activate**.

6 Press **(OK)** button to select **Activate**.

9 Press **▼** button to highlight **Off**, **Once** or **Daily**.

PHILIPS	
Timer	
Sleep	Off
Time	Once
Start Time	Daily
Stop Time	
Channel	
Activate	
Display	

Activate settings:

- **Off** – To cancel wake up clock.
- **Once** – To set wake up clock to activate once only.
- **Daily** – To set wake up clock to activate everyday at this time.

10 Press **(MENU)** button to exit the on-screen menus.

Locking and unlocking the TV side control

Use the Child Lock feature if you need to lock the functions of all the control buttons except the power button on your TV. The buttons on the remote control still works.

Activating the Child Lock

- 1 Press **MENU** button to display the on-screen menus.
- 2 Press **▼** button to highlight **Features** menu.
- 3 Press **OK** button to select **Features** menu.
- 4 Press **▼** button to highlight **Child Lock**.
- 5 Press **OK** button to select **Child Lock**.
- 6 Press **▼** button to highlight **On**.
- 7 Press **OK** button to confirm the setting.
- 8 Press **MENU** button to exit the on-screen menus.

PHILIPS	
Main	
Picture	Timer
Sound	Child Lock
Features	Parental Lock
Install	Active Control
	Ambilight

PHILIPS	
Features	
Timer	Off
Child Lock	On
Parental Lock	
Pixel Plus	
Ambilight	

Deactivating the Child Lock

Repeat steps **1** to **5** from the previous section of "Activating the Child Lock".

- 6 Press **▲** button to highlight **Off**.
- 7 Press **OK** button to confirm the setting.
- 8 Press **MENU** button to exit the on-screen menus.

PHILIPS	
Features	
Timer	Off
Child Lock	On
Parental Lock	
Pixel Plus	
Ambilight	

Controlling TV program access

The **Parental Lock** feature lets you control the type of TV programs that can be accessed with the built-in program ratings based on age and content.

Accessing Parental Lock

1 Press **MENU** button to display the on-screen menus.

2 Press **▼** button to highlight **Features** menu.

3 Press **OK** button to select **Features** menu.

4 Press **▼** button to highlight **Parental Lock**.

5 Press **OK** button to select **Parental Lock**. If you are using **Parental Lock** for the first time, you must enter the default code 0711.

6 Press the number buttons (0-9) to enter the code.

If you see "Incorrect" below the code you have just entered, press the numbers again. If you see "Correct", the TV will display the Parental Lock menu and highlight the item "Lock Channel".

7 Press **OK** button to select **Lock Channel**.

8 Press **▲** or **▼** button to highlight the channel number that you want to lock.

9 Press **OK** button to confirm locking the channel. A **🔒** symbol appears next to the channel number shows that it is locked. To unlock, press **OK** button again. The **🔒** symbol disappears.

Repeat steps 8 to 9 for other channel numbers that you want to lock.

10 Press **MENU** button to exit the on-screen menus.

PHILIPS	
Main	
Picture	Timer
Sound	Child Lock
Features	Parental Lock
Install	Active Control
	Ambilight

PHILIPS	
Features	
Timer	[-]-[-]-[-]
Child Lock	Access Code
Parental Lock	
Pixel Plus	
Ambilight	
Demo	

PHILIPS	
Features	
Timer	[*][*][*][*]
Child Lock	Correct
Parental Lock	
Pixel Plus	
Ambilight	
Demo	

PHILIPS	
Parental Lock	
Lock Channel	002
Change Code	003
Clear All	004
Lock All	005 🔒
	006
	007
	008
	009

Controlling TV program access

Changing the access code

Repeat steps 1 to 6 from the previous section of “Controlling TV program access”.

7 Press **▼** button to highlight **Change Code**.

8 Press **OK** button to select **Change Code**.

9 Press the number buttons (0-9) to enter a new code.

10 Press **OK** button to enter code into the TV’s memory.
When “Confirm code” appears below the code you have just entered, press the numbers again. You will see “Confirmed” and the code is changed.

11 Press **OK** button to confirm the setting.

12 Press **MENU** button to exit the on-screen menus.

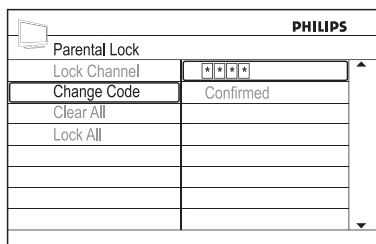
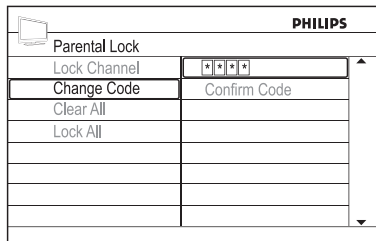
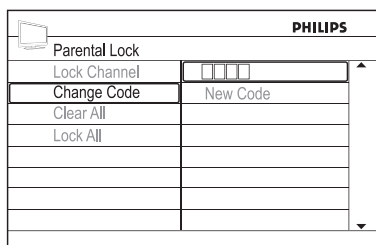
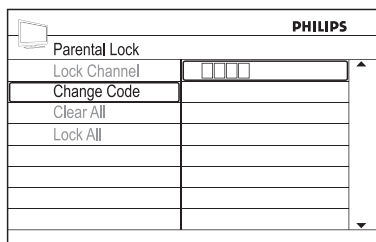

Controlling TV program access

Locking all channels

Repeat steps **1** to **6** from the previous section of “Accessing Parental Lock”.

7 Press **▼** button to highlight **Lock All**.

8 Press **OK** button to select **Lock All**.

9 Press **OK** button to select **Yes**.

“Locked” appears below to confirm your selection. From now on you have to key in the access code before you can call up all channels with the number buttons.

10 Press **MENU** button to exit the on-screen menus.

PHILIPS	
Parental Lock	
Lock Channel	Yes
Change Code	Locked
Clear All	
Lock All	

Unlocking all channels

Repeat steps **1** to **6** from the previous section of “Accessing Parental Lock”.

7 Press **▼** button to highlight **Clear All**.

8 Press **OK** button to select **Clear All**.

9 Press **OK** button to select **Yes**.

“Cleared” appears below to confirm your selection.

10 Press **MENU** button to exit the on-screen menus.

PHILIPS	
Parental Lock	
Lock Channel	Yes
Change Code	Cleared
Clear All	
Lock All	

Switching on and off Active Control

Switch on the Active Control feature to optimise picture quality from whatever the source.

Switching on Active Control

- 1 Press **MENU** button to display the on-screen menus.
- 2 Press **▼** button to highlight **Features** menu.
- 3 Press **OK** button to select **Features** menu.
- 4 Press **▼** button to highlight **Active Control**.
- 5 Press **OK** button to select **Active Control**.
- 6 Press **▼** button to highlight **On**.
- 7 Press **OK** button to confirm the setting.
- 8 Press **MENU** button to exit the on-screen menus.

PHILIPS	
Main	
Picture	Timer
Sound	Child Lock
Features	Parental Lock
Install	Active Control
	Ambilight

PHILIPS	
Features	
Timer	Off
Child Lock	On
Parental Lock	
Active Control	
Ambilight	

Switching off Active Control

Repeat steps **1** to **5** from the previous section of "Switching on Active Control".

- 6 Press **▲** button to highlight **Off**.
- 7 Press **OK** button to confirm the setting.
- 8 Press **MENU** button to exit the on-screen menus.

PHILIPS	
Features	
Timer	Off
Child Lock	On
Parental Lock	
Active Control	
Ambilight	

Ambilight (Applicable on selected models)

The Ambilight feature offers you a relaxed viewing and unique ambiance via a soft light glow on the two sides of the TV. Research has shown that watching television with adapted ambient lighting promotes more relaxed TV viewing. The Ambilight colours automatically adapt to the images on the screen to add a new sensation to the viewing experience.

Switching on Ambilight

- 1 Press **MENU** button to display the on-screen menus.
- 2 Press **▼** button to highlight **Features** menu.
- 3 Press **OK** button to select **Features** menu.
- 4 Press **▼** button to highlight **Ambilight**.
- 5 Press **OK** button twice to select **Ambilight**.
- 6 Press **▼** button to highlight **On**.
- 7 Press **OK** button to confirm the setting.
- 8 Press **MENU** button to exit the on-screen menus.

Switching off Ambilight

Repeat steps **1** to **5** from the previous section of "Switching on Ambilight".

- 6 Press **▲** button to highlight **Off**.
- 7 Press **OK** button to confirm the setting.
- 8 Press **MENU** button to exit the on-screen menus.

PHILIPS	
Main	
Picture	Timer
Sound	Child Lock
Features	Parental Lock
Install	Active Control
	Ambilight

PHILIPS	
Features	
Timer	Ambilight
Child Lock	Brightness
Parental Lock	Mode
Active Control	Colour
Ambilight	Custom Colour
	Balance

PHILIPS	
Ambilight	
Ambilight	Off
Brightness	On
Mode	
Colour	
Custom Colour	
Balance	

PHILIPS	
Ambilight	
Ambilight	Off
Brightness	On
Mode	
Colour	
Custom Colour	
Balance	

Settings for Ambilight (Applicable on selected models)

Adjusting brightness

Repeat steps ❶ to ❹ from the previous section of “Switching on Ambilight”.

- ❺ Press **OK** button to select **Ambilight**.
- ❻ Press **▼** button to highlight **Brightness**.
- ❼ Press **OK** button to select **Brightness**.
- ❽ Press **▲** or **▼** button to adjust the amount of light output of ambient light.
- ❾ Proceed to other settings, otherwise press **MENU** button to exit the on-screen menus.

PHILIPS	
Features	
Timer	Ambilight
Child Lock	Brightness
Parental Lock	Mode
Active Control	Colour
Ambilight	Custom Colour
	Balance

PHILIPS	
Ambilight	
Ambilight	
Brightness	100
Mode	53
Colour	
Custom Colour	
Balance	

Selecting Ambilight modes

Repeat steps ❶ to ❹ from the previous section of “Switching on Ambilight”.

- ❻ Press **▼** button to highlight **Mode**.
- ❼ Press **OK** button to select **Mode**.
- ❽ Press **▲** or **▼** button to select the different modes available.
- ❾ Press **OK** button to confirm setting.

PHILIPS	
Ambilight	
Ambilight	Colour
Brightness	Relaxed
Mode	Moderate
Colour	Dynamic
Custom Colour	
Balance	

Colour – ensures constant light according to the settings in the Colour menu.

Relaxed – smoothens the rate of brightness and colour. This gives a more relaxed viewing experience.

Moderate – this is a pre-defined rate of brightness and colour change.

Dynamic – ensures a dynamic change of rate of brightness and colour.

- ❿ Press **MENU** button to exit the on-screen menu.

Settings for Ambilight (Applicable on selected models)

Selecting Ambilight colour

Repeat steps **1** to **4** from the previous section of “Switching on Ambilight”.

- 5** Press **(OK)** button to select **Ambilight**.
- 6** Press **▼** button to highlight **Colour**.
- 7** Press **(OK)** button to select **Colour**.
- 8** Press **▲** or **▼** button to select.
- 9** Press **(OK)** button to confirm setting.

List of colours available:

- Warm white
- Cool white
- Blue
- Red
- Green
- Yellow
- Magenta
- Custom – This is the settings selected in the “Custom Colour” menu.

- 10** Proceed to other settings, otherwise press **(MENU)** button to exit the on-screen menus.

PHILIPS	
Features	
Timer	Ambilight
Child Lock	Brightness
Parental Lock	Mode
Active Control	Colour
Ambilight	Custom Colour
	Balance

PHILIPS	
Ambilight	
Ambilight	Warm white
Brightness	Cool white
Mode	Blue
Colour	Red
Custom Colour	Green
Balance	Yellow
	Magenta
	Custom

Settings for Ambilight (Applicable on selected models)

Using custom colours

Repeat steps ① to ④ from the previous section of “Switching on Ambilight”.

⑤ Press **(OK)** button to select **Ambilight**.

⑥ Press **▼** button to highlight **Custom Colour**.

⑦ Press **(OK)** button to select **Custom Colour**.

⑧ Press **▲** or **▼** button to select **Palette** or **Saturation**.

Palette – adjusts the general colour of the light output.

Saturation – adjusts the colour intensity of light output.

⑨ Press **(OK)** button to confirm setting.

⑩ Press **▲** or **▼** button to adjust.

⑪ Proceed to other settings, otherwise press **(MENU)** button to exit the on-screen menus.

PHILIPS	
Features	
Timer	Ambilight
Child Lock	Brightness
Parental Lock	Mode
Active Control	Colour
Ambilight	Custom Colour
	Balance

PHILIPS	
Ambilight	
Ambilight	Palette
Brightness	Saturation
Mode	
Colour	
Custom Colour	
Balance	

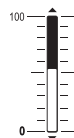
PHILIPS	
Ambilight	
Palette	
Saturation	

Selecting Ambilight balance

Repeat steps ① to ④ from the previous section of “Switching on Ambilight”.

⑤ Press **(OK)** button to select **Ambilight**.

⑥ Press **▼** button to highlight **Balance**.

⑦ Press **(OK)** button to select **Balance**.

Use this feature to adjust the colour intensity on the sides of the picture.

⑧ Press **▲** or **▼** button to adjust.

⑨ Proceed to other settings, otherwise press **(MENU)** button to exit the on-screen menus.

PHILIPS	
Features	
Timer	Ambilight
Child Lock	Brightness
Parental Lock	Mode
Active Control	Colour
Ambilight	Custom Colour
	Balance

PHILIPS	
Ambilight	
Ambilight	
Balance	

Displaying Demo mode

Displaying Demo mode

① Press  button to start. The screen split into two. The right side (Off) shows the picture before enhancement. The left side (On) shows the picture after enhancement.

② Press  button to return to normal screen.

NOTE:

Pixel Plus Demo feature works only in widescreen and not in other modes.

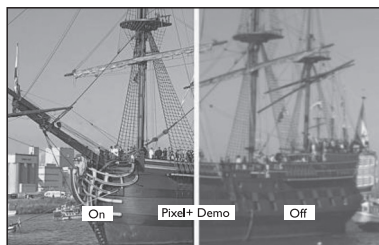

Accessing Teletext (Not applicable for models sold in China)

Teletext is an information system broadcast by certain channels. This service can be operated with specific buttons on the remote control.

Switching on/off Teletext

① Press the number buttons to select a channel which broadcast teletext.

② Press  button to switch on the teletext service.

Selecting a page

① Press the number buttons to select a page e.g. 800. Press the CH + or – to select a higher or lower page number.



Fasttext (only applicable when Fasttext is in broadcast)

① Press the colour buttons corresponding to the colour menu at the bottom of the page to select that item.



Selecting index (contents) page

① Press the  button to select or return to the index page.



Selecting subpage directly

① Press  button to select the previous page or  button to select the next page.

Enlarging a page

① Press  or  button to enlarge the top half of the page. Press again to enlarge the bottom half of the page. Press again will return to normal size.

Page hold

① Certain pages contain sub-pages which are automatically displayed successively. This key  is used to stop or resume sub-page progression. Use the   keys to select previous or next sub-page.

Hidden information

① Press  button to display or hide the concealed information such as solutions to games or riddles.

***Not applicable for models sold in China.**

Selecting picture formats

The pictures you get on your TV may be in the widescreen (16:9) or standard (4:3) format depending on your broadcast stations. You can select various screen formats to suit the type of programs you watch.

1 Press  button repeatedly to select the picture that you want.

Picture Formats:

4:3 – Entire picture is reproduced on the screen with black bands on left and right of screen.

Movie Expand 14:9 – The picture is enlarged to fit horizontally with black bands visible at the sides of the screen.

Movie Expand 16:9 – The picture is enlarged to fill up the screen and eliminate the top and bottom black bands. Some information at the top and bottom of the picture is cropped off.

Subtitle Zoom – The 4:3 format programme is displayed on the entire screen leaving the subtitles area visible. Some information at the top of the picture is cropped off.

Super Zoom – Removes black bands on sides of the screen of 4:3 format programmes with minimal distortion.

Widescreen – The picture is displayed in its original proportions as transmitted.

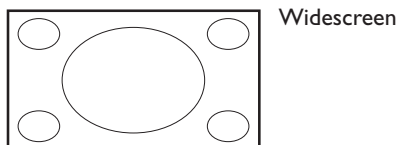
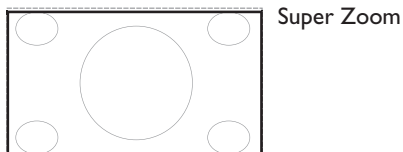
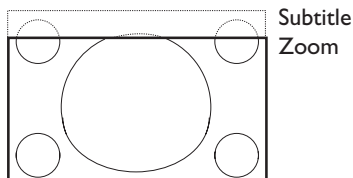
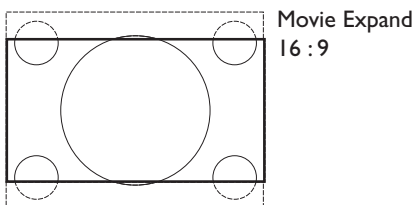
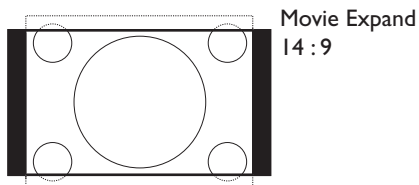
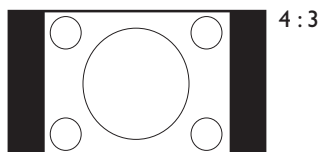

Selecting Smart picture and Smart sound settings

The TV comes with pre-set **Smart Sound** and **Smart Picture** settings to match different listening and viewing environment.

Smart sound settings

① Press  button repeatedly to select the sound settings that you want.

Movie – Gives you the sensation of being in the middle of the action.

Music – Low tones to emphasize music.

Voice – High tones to emphasize dialogue.

Personal – Your own sound settings can be stored here. You can only change the settings for Personal.

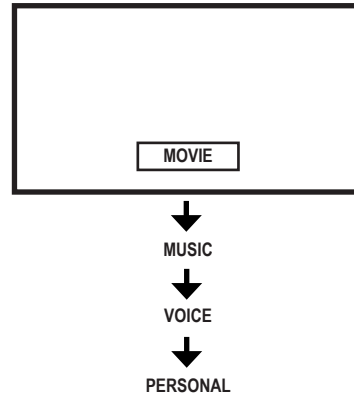

Smart picture settings

① Press  button repeatedly to select the picture settings that you want.

Rich– Brilliant and sharp pictures for bright environment.

Natural – suitable for living room conditions.

Soft – Suitable for poor signals and living room conditions.

Multimedia – Optimal settings for graphical media.

Personal – Your own picture settings can be stored here. You can only change the settings for Personal.

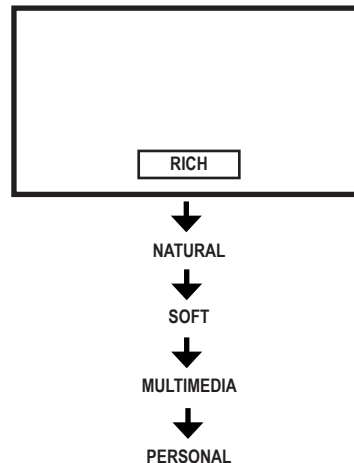

NOTE:

If you change any settings in the **Picture** or **Sound** menus, your previous Personal setting will be overwritten with the current changes you made.

Using the TV as a computer monitor

The TV is equipped with a VGA port for you to use as a computer monitor. Connect your computer to the TV via the VGA cable (not supplied). Refer to the Quick Connect Guide for connecting the computer to your TV.

- 1 Press **AV** button to call up the source list.
- 2 Press **▼** button to highlight **VGA**.
- 3 Press **OK** button to select **VGA**.

Source List
TV
AV
SIDE
CVI 1
CVI 2
VGA
HDMI 1
HDMI 2

Setting the picture, sound and features in VGA mode

Most of the picture, sound and features settings are the same as those in the TV mode. The additional items are:

Picture settings:

Horizontal – To adjust the picture to the left or right.

Vertical – To adjust the picture upwards or downwards.

Feature settings:

Phase / Clock – To match the TV's and computer's display settings.

Auto Adjust – To synchronise the TV and computer's Phase/Clock rate automatically. The geometry will also be adjusted.

Reset – To set back to the factory default setting.

NOTE:

The best supported format is 1024 X 768 @ 60 Hz.

PHILIPS	
Main	
Picture	Brightness ▲
Sound	Colour
Features	Contrast
Install	Sharpness
	Horizontal
	Vertical
	Colour Temp
	Contrast + ▼

PHILIPS	
Main	
Picture	Timer ▲
Sound	Child Lock
Features	Parental Lock
Install	Phase
	Clock
	Auto Adjust
	Reset ▼

NOTE:

- If you are using the DVI output from your computer to connect to the TV, use a DVI to HDMI adapter cable. The audio cable needs to be connected to the L / R Audio jacks (AV) of the TV.
- Press the **AV** key to display Source List and use the **▲ ▼** key to select **HDMI 1** or **HDMI 2**.

Using the TV in High Definition (HD) mode

The HD (High Definition) mode allows you to enjoy clearer and sharper pictures if you are using HD equipment that can produce high definition video signals.

Connecting the HD equipment

- 1 Connect the HDMI or DVI output from your HD equipment to the HDMI 1 or HDMI 2 connector of the TV. Use a DVI to HDMI cable if DVI output is connected.
- 2 If you are using DVI output from your HD equipment to connect to the TV, the audio cable needs to be connected to the L / R Audio jacks (AV) of the TV.
- 3 Press the **AV** key to display Source List and use the **▲ ▼** key to select **HDMI 1** or **HDMI 2**.
- 4 Press the **▶ / OK** key to switch to the selected source.

Source List
TV
AV
SIDE
CVI 1
CVI 2
VGA
HDMI 1
HDMI 2

- 5 To exit the menu, press the **MENU** key.

Picture menu

- The Picture menu comprises **Brightness, Colour, Contrast, Sharpness, Colour Temp., Contrast+, Horizontal Shift,** and **Vertical Shift**.
- Except for the **Horizontal Shift** and the **Vertical Shift** features, all the other functions work exactly in the same way as the features in the **TV Picture** menu.
- **Horizontal Shift** feature allows you to adjust horizontal position of the image.
- **Vertical Shift** feature allows you to adjust vertical position of the image.

Sound menu

- The Sound menu comprises **Equalizer, Balance,AVL** and **Incr. Surround** features and work exactly in the same way as the **TV Sound** menu.

Features menu

- The Features menu comprises **Timer, Child Lock, Parental Lock** and **Active Control** features. Except for **Mode Selection** feature, all the other features work exactly in the same way as the **TV Sound** menu.

Controlling the TV settings while in HD mode

- 1 Press the **MENU** key to display the main menu.
- 2 Press the **▲ ▼** keys to select Picture, Sound or Features and the **▶ / OK** key to enter the selected item menu.
- 3 Press the **▲ ▼** key to select the settings and the **◀ ▶** key to select or adjust setting.
- 4 To return to previous menu, press the **◀** key.

Using the TV in High Definition (HD) mode

Mode Selection in Features menu

Note:

Applicable only to 480p and 720p.

When you connect HD (High Definition) equipment (HDMI only) supporting resolution of **480p** or **720p**, the **Mode Selection** feature will be available in the **Features** menu. The **Mode Selection** allows you to select between the **PC** and **HD** mode.

- 1 Press the **MENU** key.
- 2 Press the **▲ ▼** keys to access the **Features** menu and press the **▶ / OK** key.
- 3 Press the **▼** key to select **Mode Selection**.
- 4 Press the **▶** key to access **Mode Selection** mode.
- 5 Press the **▲ ▼** keys to select **PC** or **HD** mode.
- 6 To exit the menu, press the **MENU** key.

PHILIPS	
Features	
Timer	PC
Child Lock	HD
Parental Lock	
Mode Selection	
Active Control	

Display (native 1080) in Features menu *

Note

This **Display (native 1080)** feature is only applicable to 1080p models only.

When you connect HD (High Definition) equipment (HDMI or Y, Pb, Pr) supporting resolution of **1080i**, the **Display (native 1080)** feature will be available in the **Features** menu. This feature allows you to watch the original HD format (1080i only). This is a true HD resolution from your input signals.

PHILIPS	
Features	
Timer	native 1080
Child Lock	
Parental Lock	
Active Control	
Display	

PHILIPS	
Display	
native 1080	Off
	On

*Applicable on selected models only.

Using the TV in High Definition (HD) mode

- 1 Press the **MENU** key.
- 2 Press the **▲ ▼** keys to access the **Features** menu and press the **▶ / OK** key.
- 3 Press **▼** key to select **Display**.
- 4 Press the **▶** key to access **Display** mode.
- 5 Press the **▶** key twice to access the **Off/On** option in the **native 1080**.
- 6 Press the **▲ ▼** keys to select **Off/On** option. Select **On** option to allow you to watch original HD format (1080i only).
- 7 To exit the menu, press the **MENU** key.

Supported formats

Non 1080p models				
HD format	480p,	576p,	720p,	1080i
SD format	480i,		576i,	

1080p models					
HD format	480p	576p	720p	1080p	1080i
SD format	480i,			576i,	

Note

Your Philips TV is HDMI compliant. If you do not get a good picture, please change the video format on your device (DVD player, cable set-top box, etc.) to a standard format. For example, for DVD player, select 480p, 576p, 720p, 1080i or 1080p.

Please note that this is not a defect of the TV set.

Connecting to other devices

The TV is equipped with several audio and video connection jacks for you to connect to devices such as DVD players and recorders, home theatre systems, high-definition equipments, etc. Refer to the Quick Connect Guide for connection instructions.

1 Press **AV** button call up the source list.

2 Press **▼** button to highlight the connection input.

3 Press **OK** button to confirm selection.

Sources:

TV – Normal TV broadcast via the 75 ohm antenna connector.

AV – Composite video and audio input.

SIDE – Headphone jack, Composite video and audio and S-Video input.

CVI 1 – Component video (Y Pb Pr) with audio input.

CVI 2 – Component video (Y Pb Pr) with audio input.

VGA – Video Graphics Array with audio input.

HDMI 1 – High Definition Multimedia Interface input.

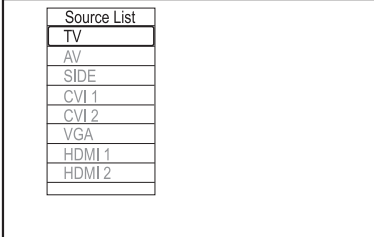

HDMI 2 – High Definition Multimedia Interface input.





Source List
TV
AV
SIDE
CVI 1
CVI 2
VGA
HDMI 1
HDMI 2

Troubleshooting

Before calling Service, refer to the Troubleshooting topic for a list of symptoms and solutions which may address your problem.

Symptom	Possible solutions
No display on screen	Check that the power cable is connected properly into the mains socket and to the TV. Disconnect power plug from the wall socket. Wait for about 60 seconds and re-connect the plug. Switch on the TV. Press the  button on the remote control.
Poor reception (or "snowy" picture)	Check antenna connection is connected properly from the TV to the antenna source. Adjust the picture manually. Check that the correct TV system is selected. Press the  button to check the incoming signal strength indication at the top of the TV screen.
No picture	Check that the antenna and power cables are connected properly. Check that the correct input source is selected. Check that the Parental Lock function is switched off.
No sound on certain channels	Check that the correct TV system is selected.
No sound	Check that the volume is not set to the minimum. Check that the "Mute" function is not switched on. Check that the correct connection source is selected.
Sound interference	Switch off any nearby electrical appliances such as hair dryer or vacuum cleaner.
TV not responding to remote	Check that there is no obstacle between the remote control and the TV. Check that the batteries are correctly inserted into the remote control. Replace batteries if necessary.
Spots on the TV screen that do not change colour	No action needed because the LCD panel is built with very high precision technology giving you the fine picture details. Occasionally, a few non-active pixels may appear on the screen as a fixed point of red, blue, green or black. This does not affect the performance of the set.

Troubleshooting

Symptom	Possible solutions
Intermittent flickering when in HD mode	<ul style="list-style-type: none">• Check the user manual of the digital equipment you are connecting. Picture noise is noticeable if the connected digital equipment such as DVD player or Set-Top box fail.• Use a standard-compliant (high-quality) HDMI cable.
No sound or picture but front panel red light is lit	Press the  button on the remote control.
The Colour becomes faint in S-Video mode	Check that the S-Video cable is connected properly.
VGA mode does not work	Check VGA cable is connected securely. Check that the correct AV source is selected. Press the  button to display the source list and select the correct one. Check whether you have configured the computer to a compatible display resolution. Check the graphics card setting of the computer.
Black bar on the top and bottom of the screen in VGA mode	Change PC refresh rate to 60 Hz.

Specifications

TV Models	32PFL7332	32PFL7932	42PFL7432	52PFL7432
TV System	PAL I, PAL B/G, PAL D/K, SECAM B/G, SECAM D/K			
Video Playback	NTSC, SECAM, PAL			
Power				
Mains	100-250 V, 50/60 Hz			
Standby consumption	< 1 W			
Display				
Type	LCD WXGA Active matrix TFT			
Screen size	32" (80 cm)	32" (80 cm)	42" (107 cm)	52" (132 cm)
Resolution				
Panel resolution	1366 X 768p		1920 X 1080p	
Supported Display	Computer formats			
	640 x 480 - 60, 72, 75, 85Hz		720 x 400 - 70Hz	
	1024 x 768 - 60, 70, 75, 85Hz			
	Video formats			
640 x 480i - 60Hz	640 x 480p - 60Hz	720 x 576i - 50Hz		
720 x 576p - 50Hz	1280 x 720p - 50, 60Hz	1920 x 1080i - 50, 60Hz		
Sound				
Output power	2 x 10 W			
Connectivity				
AV	CVBS In, Audio L/R In, S-Video In			
CVI 1	Y Pb Pr, Audio L/R In			
CVI 2	Y Pb Pr, Audio L/R In			
HDMI 1	•	•	•	•
HDMI 2	•	•	•	•
PC	PC VGA In, PC Audio In			
AV Out	CVBS Out, Audio L/R Out			
SIDE	CVBS In, Audio L/R In, S-Video In, Headphone Out			
Aerial Input	75 Ohm coaxial (IEC75)			

Specifications

TV Models	32PFL7332	32PFL7932	42PFL7432	52PFL7432
Accessories	Quick Start Guide, User Manual, Registration card, Warranty certificate, Power cord, Table-top stand, Remote control, AAA batteries x2			
Dimensions				
Set weight	14.2 kg	14.2 kg	26.5 kg	40 kg
Set weight with stand	17 kg	17 kg	33.5 kg	50 kg
Set dimensions (W x H x D) mm	W 805 H 546.5 D 115.5	W 805 H 546.5 D 115.5	W 1046 H 686 D 116	W 1288.6 H 834.5 D 123.5
Set dimensions with stand (Wx H x D) mm	W 805 H 609 D 210	W 805 H 609 D 210	W 1046 H 748.6 D 264.5	W 1288.6 H 901.3 D 325

Specifications subject to change without notice.



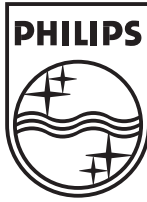

Specifications are subject to change without notice.
Trademarks are the property of Koninklijke Philips Electronics N.V. or their respective owners.
2004 © Koninklijke Philips Electronics N.V. All rights reserved.

www.philips.com
3139 125 38213