

Register your product and get support at

www.philips.com/welcome

4000 Series

User manual

PHILIPS



Environmental Protection Use Period

This logo labelled on the product itself indicates that the Environmental Protection Use Period thereof is 10 years.

The Environmental Protection Use Period of electrical information products refers to the time period during which the toxic and hazardous substances or elements contained within the product will not leak or suddenly spoil, and users of such products will not cause any serious environmental pollution or serious damage to human and property.

During the Environmental Protection Use Period, please use this product according to the instructions given in this user manual.

The Environmental Protection Use Period does not cover consumable parts: the battery.

Suggestive description of the Recycling Administrative Regulations for Waste Electrical and Electronics Products

In order to care and protect the Earth in a better way, please adhere to the national and applicable laws in relation to the recycling management of waste electrical and electronics products when the user no longer needs to use this product, or when it has reached the end of its product life.

Contents

1	Caution	2
----------	----------------	----------

2	Important	3
----------	------------------	----------

3	Your TV	5
	Control Panel	5
	Remote Control	5
	Remote control usage	6

4	Use your TV	7
	Turn on/off the TV, or switch to Standby	7
	Switch channels	7
	Watch connected devices	8
	Adjust TV volume	8

5	TV Operation	9
	Channel	9
	Sources	10
	Time	10
	LOCK	11
	SETTING	11
	PICTURE	11
	SOUND	12
	MULTIMEDIA	12

6	Product information	13
	Display resolutions	13
	Multimedia	13
	Sound power	13
	Inherent resolution	13
	Tuner / Reception / Transmission	13
	Remote Control	13
	Power Supply	13
	Supported TV mounts	13
	Open source license	14

7	Troubleshooting	15
	General issues	15
	Channel issues	15
	Picture issues	15
	Sound issues	16
	HDMI connection issues	16
	Computer connection issues	16
	Contact us	16

8	Terms of Warranty	17
----------	--------------------------	-----------

1 Caution

2016© TP Vision Europe B.V. All rights reserved. Specifications are subject to change without notice. Trademarks are the property of Koninklijke Philips N.V. or their respective owners. TP Vision Europe B.V. reserves the right to change products at any time without being obliged to adjust earlier supplies accordingly. The material in this manual is believed adequate for the intended use of the system. If the product, or its individual modules or procedures, are used for purposes other than those specified herein, confirmation of their validity and suitability must be obtained. TP Vision Europe B.V. warrants that the material itself does not infringe any United States patents. No further warranty is expressed or implied.

TP Vision Europe B.V. cannot be held responsible neither for any errors in the content of this document nor for any problems as a result of the content in this document. Errors reported to Philips will be adapted and published on the Philips support website as soon as possible.

Terms of warranty

- Risk of injury, damage to TV or void of warranty! Do not attempt to repair the TV yourself.
- Use the TV and accessories only as intended by the manufacturer.
- The caution sign printed on the back of the TV indicates risk of electric shock. Never remove the TV cover. Always contact Philips Customer Support for service or repairs.



Any operation expressly prohibited in this manual, or any adjustments and assembly procedures not recommended or authorised

in this manual shall void the warranty.

Pixel characteristics

This LCD/LED product has a high number of color pixels. Although it has effective pixels of 99.999% or more, black dots or bright points of light (red, green or blue) may appear constantly on the screen. This is a structural property of the display (within common industry standards) and is not a malfunction.

Mains fuse

This TV is fitted with an approved moulded plug. Should it become necessary to replace the mains fuse, this must be replaced with a fuse of the same value as indicated on the plug (example 10A).

- 1 Remove fuse cover and fuse.
- 2 The replacement fuse must comply with BS 1362 and have the ASTA approval mark. If the fuse is lost, contact your dealer in order to verify the correct type.
- 3 Refit the fuse cover.

Copyright



MHL, Mobile High-Definition Link and the MHL Logo are trademarks or registered trademarks of the MHL, LLC.



HDMI, the HDMI logo and High-Definition Multimedia Interface are trademarks or registered trademarks of HDMI licensing LLC in the United States and other countries.

All other registered and unregistered trademarks are the property of their respective owners.



Manufactured under license from Dolby Laboratories. Dolby, Dolby Audio, and the double-D symbol are trademarks of Dolby Laboratories.

2 Important

Read and understand all instructions before you use your TV. If damage is caused by failure to follow instructions, the warranty does not apply.

Safety

Risk of electric shock or fire!

- Never expose the TV to rain or water. Never place liquid containers, such as vases, near the TV. If liquids are spilt on or into the TV, disconnect the TV from the power outlet immediately. Contact Philips Consumer Care to have the TV checked before use.
- Never place the TV, remote control or batteries near naked flame or rather heat sources, including direct sunlight. To prevent the spread of fire, keep candles or other flames away from the TV, remote control and batteries at all times.



- Never insert objects into the ventilation slots or other openings on the TV.
- When the TV is swivelled ensure that no strain is exerted on the power cord. Strain on the power cord can loosen connections and cause arcing.
- To disconnect the TV from the mains power, the power plug of the TV must be disconnected. When disconnecting the power, always pull the power plug, never the cord. Ensure that you have full access to the power plug, power cord and outlet socket at all times.

Risk of short circuit or fire!

- Never expose the remote control or batteries to rain, water or excessive heat.
- Avoid force coming onto power plugs. Loose power plugs can cause arcing or fire.

Risk of injury or damage to the TV!

- Two people are required to lift and carry a TV that weighs more than 25 kg or 55 lbs.
- When stand mounting the TV, use only the supplied stand. Secure the stand to the TV tightly. Place the TV on a flat, level surface that can support the combined weight of the TV and the stand.
- When wall mounting the TV, use only a wall mount that can support the weight of the TV. Secure the wall mount to a wall that can support the combined weight of the TV and wall mount. TP Vision Europe B.V. bears no responsibility for improper wall mounting that results in accident, injury or damage.
- If you need to store the TV, disassemble the stand from the TV. Never lay the TV on its back with the stand installed.
- Before you connect the TV to the power outlet, ensure that the power voltage matches the value printed on the back of the TV. Never connect the TV to the power outlet if the voltage is different.
- Parts of this product may be made of glass. Handle with care to avoid injury and damage.

Risk of injury to children!

Follow these precautions to prevent the TV from toppling over and causing injury to children:

- Never place the TV on a surface covered by a cloth or other material that can be pulled away.
- Ensure that no part of the TV hangs over the edge of the surface.
- Never place the TV on tall furniture (such as a bookcase) without anchoring both the furniture and TV to the wall or a suitable support.
- Educate children about the dangers of climbing on furniture to reach the TV.

Risk of swallowing batteries!

- The product/remote control may contain a coin-type battery, which can be swallowed. Keep the battery out of reach of children at all times!

Risk of overheating!

- Never install the TV in a confined space. Always leave a space of at least 4 inches or 10 cm around the TV for ventilation. Ensure curtains or other objects never cover the ventilation slots on the TV.

Risk of injury, fire or power cord damage!

- Never place the TV or any objects on the power cord.
- Disconnect the TV from the power outlet and antenna before lightning storms. During lightning storms, never touch any part of the TV, power cord or antenna cable.

Risk of hearing damage!

- Avoid using earphones or headphones at high volumes or for prolonged periods of time.

Low temperatures

- If the TV is transported in temperatures below 5 °C or 41 °F, unpack the TV and wait until the TV temperature matches room temperature before connecting the TV to the power outlet.

Screen care

- Avoid stationary images as much as possible. Stationary images are images that remain on-screen for extended periods of time. Example: on-screen menus, black bars and time displays. If you must use stationary images, reduce screen contrast and brightness to avoid screen damage.
- Unplug the TV before cleaning.
- Clean the TV and frame with a soft, damp cloth. Never use substances such as alcohol, chemicals or household cleaners on the TV.

- Risk of damage to the TV screen! Never touch, push, rub or strike the screen with any object.
- To avoid deformations and color fading, wipe off water drops as soon as possible.

Recycling



Your product is designed and manufactured with high quality materials and components, which can be recycled and reused.



When this crossed-out wheeled bin symbol is attached to a product it means that the product is covered by the European Directive 2002/96/EC. Please inform yourself about the local separate collection system for electrical and electronic products.

Please act according to your local rules and do not dispose of your old products with your normal household waste.

Correct disposal of your old product helps to prevent potential negative consequences for the environment and human health.



Your product contains batteries covered by the European Directive 2006/66/EC, which cannot be disposed of with normal household waste. Please inform yourself about the local rules on separate collection of batteries because correct disposal helps to prevent negative consequences for the environment and human health.

3 Your TV

Congratulations on your purchase, and welcome to Philips! To fully benefit from the support that Philips offers, register your TV at www.philips.com/welcome.

Control Panel

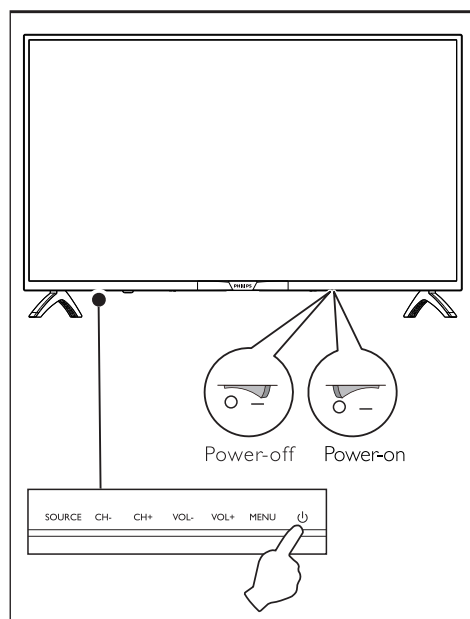

1. Indicator / Remote Control Sensor
2. SOURCE: display the list of signal sources.
3. - CH + : switch to the previous/next channel.
4. Vol-/+ : increase/reduce the volume.
5. Menu: turn on/off the main menu.
6. ⏻ : turn on/off the TV ; to cut off power supply, please unplug the power cable.

Remote Control

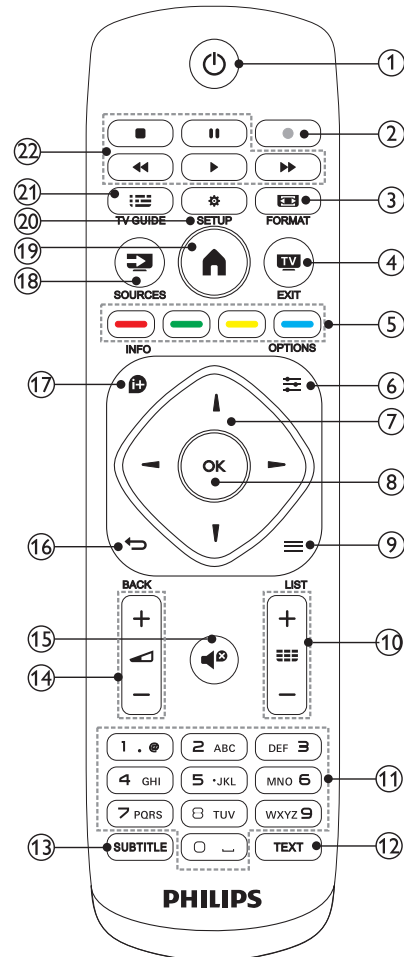

- ① ⏻ Standby/Power on
 - Switches the TV to standby if it is on.
 - Powers on the TV if it is in standby.
- ② ● Recording

Before recording, you need to prepare the following:

 1. a connected USB Hard Drive formatted on this TV.
 2. digital TV channels installed on this TV.
 - To record TV program, press the red ● (Record) on the remote control.

- To schedule a recording of an upcoming TV program, press TV GUIDE then select the TV program you wish to record. Press the red • (Record) on remote control to set the recording schedule.
- FORMAT**
Display display the image aspect ratio.
 - EXIT**
Press this button to exit menu.
 - Color key**
Special function selection keys.
 - OPTIONS**
Select a item of option settings for the TV.
 - Navigation keys**
 - In menu mode: navigate the menu.
 - OK**
 - In menu mode: confirm the input or selection.
 - LIST**
Look through channel list.
 - +/- (CH+/-)**
Switch to the previous/next channel in TV mode.
 - Numeric keys (0~9)**
Select a channel or value.
 - TEXT**
Display Teletext information.
 - SUBTITLE**
Display subtitle message, when current channel has subtitle option.
 - +/- (VOL+/-)**
Increase/reduce the volume.
 - Mute**
Mute or unmute the sound.

- BACK**
Return to the previous channel.
- INFO**
Display the program information when available.
- SOURCES**
Select an input source for the TV.
- (MENU)**
Turn on/off the menu.
- SETUP**
Display the setting options on the screen, you can adjust these items by yourself.
- TV GUIDE**
Gives instant access to TV program guide.
 - availability of electronic program guide(EPG) is dependent on broadcasters or operators.
- Shortcut keys in USB mode: Stop, Pause, Rewind, Start, Fast Forward.**

Remote control usage

When you use the remote control, hold it close to the TV and point it at the remote control sensor. Make sure that the line-of-sight between the remote control and TV is not blocked by furniture, walls or other objects.

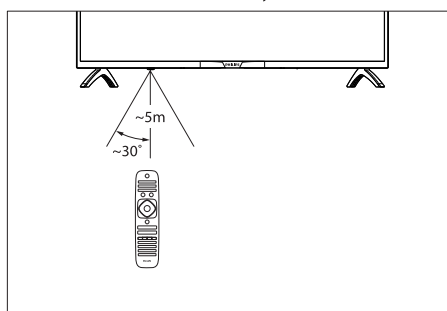

4 Use your TV

This section helps you perform basic TV operations.

Turn on/off the TV, or switch to Standby

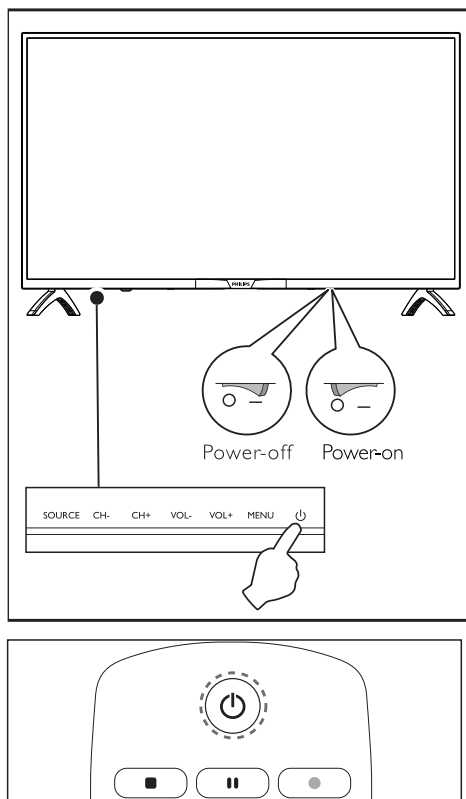

Turn on the TV

- If the indicator is off, please insert the TV power cord into a power outlet. Press the power switch to turn on the TV as shown in the figure.
- When the indicator is on, press **⏻ (Standby-On)** on the remote control or on the side of the TV to turn on the TV.

Switch to Standby

- Press **⏻ (Standby-On)** on the remote control or on the side of the TV.
 - » The standby indicator turns on.

Turn off the TV

- Press the power switch to turn off the TV as shown in the figure
 - » The standby indicator turns off.



Tip

- Though your TV consumes very little power when in standby mode, energy continues to be consumed. When not in use for an extended period of time, disconnect the TV power cable from the power outlet.

Switch channels

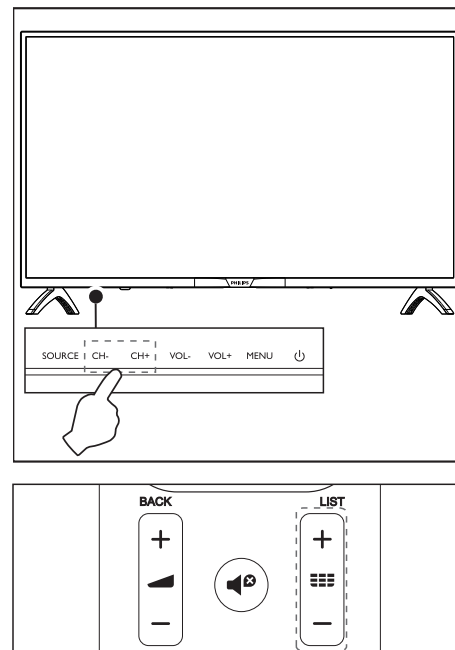

- Press **CH +/-** on the remote control or the lower right part of the TV.
- Enter a channel number using the numeric buttons on the remote control.
- Press **↶** on the remote control to switch and return to the previous channel.

Watch connected devices

Note

- Switch on the device before selecting it as an external signal source.

Use the Source button

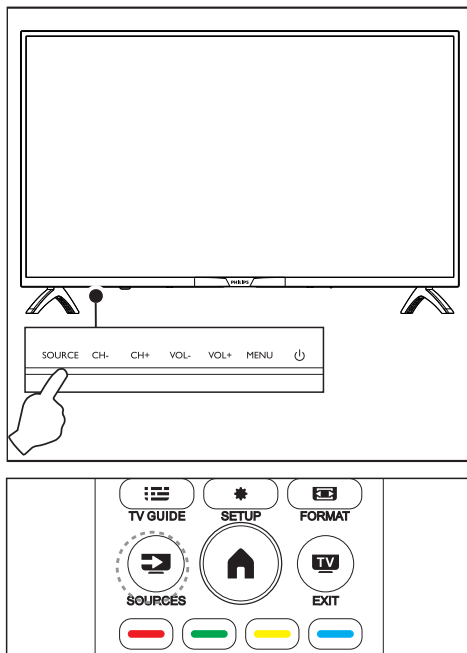

- 1 Press **SOURCE**.
» The source list appears.
- 2 Press **▲▼** to select a device.
- 3 Press **OK** to select.
» The TV switches to the selected device.

Adjust TV volume

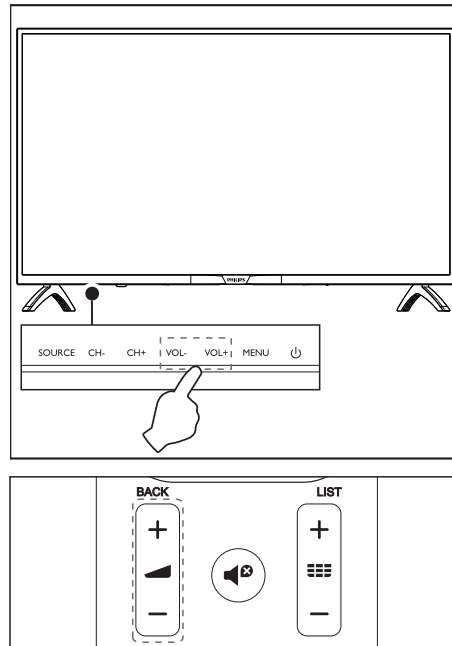

To decrease or increase volume

- Press **◀▶** on the backcover of the TV, the TV or the **-/+** on the remote control remote control.

To mute or unmute sound

- Press **Mute**.
- Press **Mute** again to restore the sound.

5 TV Operation

This section tells you how to operate the TV software.

Channel

Update channels

Programme scanning

Before you watching the programs of the TV, you need to scan the programs. (Note: Make sure that the antenna is connected properly before scanning).

DVB Antenna

Select Terrestrial or CABLE.

Auto Tuning

Press **MENU** key to enter the main menu and select CHANNEL, press **OK** key to enter channel menu, select Auto Tuning, press **▶** key to open tuning setup. You can press **▲/▼** key to adjust these options, and then press **OK** key to start searching.

Analogue Manual Tuning

Select CHANNEL, press **OK** key to enter channel menu, select Analogue Manual Tuning, then press **▶** key to enter submenu. You can press **▲/▼** key to select the item to set, and then press **◀/▶** key to adjust the options or search the channels by manual.

Digital Manual Tuning

Select CHANNEL, press **OK** key to enter channel menu, select Digital Manual Tuning, then press **◀/▶** key to select channel, press **OK** key to start searching.

Channel Edit

Select CHANNEL, press **OK** key to enter channel menu, select Channel Edit, press **OK** key enter channel list, press **▲/▼** key to select the item you'd like to edit. You can select the color keys to edit these

programmes with the tips on the screen.

Delete: Press **■** key on the remote control to delete the selected channel.

Move: Press **■** key on the remote control to highlight a channel, and press **▲/▼** key to move, then press **■** key to confirm location.

Skip: Press **■** key on the remote control to skip the channel, and press **■** key again to cancel it.

Favourite: press "0" key on the remote control to set your favourite channel, and press "0" key again to cancel it.

Signal information

Select CHANNEL, press **OK** key to enter channel menu, select Signal information, Press **OK** key to look through the signal information (it is available only in DTV mode).

CI information

Select CHANNEL, press **OK** key to enter channel menu, select CI information, Press **OK** key to look through the CI information (it is need CI CAM).

Recording List

In DTV mode, press **(Record)** key to begin recording the programme. The recording function need connect with a USB Hard Drive formatted on the TV.

To record the programme you are watching right now, press **(Record)** key on the remote control, then the recording will start immediately. When the programme was recording, you can select **■** key to stop it.

Open or delete the list of recording

Select CHANNEL, press **OK** key to enter channel menu, select Recorded list. Press **▲/▼** key to select the recordings, and press **OK** key to play or press **■** key on remote control to delete the selected recording file. You can press **EXIT** key to quit the list.

Time-shift

In DTV mode, press **■** key on the remote control, time-shift option menu will show on the screen, and the program is in suspended status. press **■** key on the remote control to stop and quit time-shift function. When you leave program for a short time, time-shift function can suspend and cache the playing program to U disk. When you resume playing, the program can continue to be played.

Schedule List

Select CHANNEL, press **OK** key to enter channel menu, select Schedule List, Press **OK** key to look through the Channel schedule list information or Recorded list information (it is available only in DTV mode).

Software Update(OAD)

Select Off or On.

Sources

Switch a device signal

In the list of connections-the Source menu-you can find the devices connected to the TV. From this Source menu, you can switch to a device.

Source menu

To open the sources menu, press **SOURCE** key on the remote control. And then press **▲/▼** key to select the connected device, press **OK** key to enter the signal source.

Time

Time settings

Off Time

Select the TV to power off automatically.

On Time

Select the TV to power on automatically.

Sleep timer

With the sleep timer, you can set the TV to switch to standby automatically after a preset time.

To set the sleep timer...

1. Press **MENU** key on the remote control, then press **◀/▶** key to select TIME on the screen, press **OK** key to enter the TIME menu.

2. Press **▲/▼** key select Sleep Timer; then press **◀/▶** key to adjust the value of standby time: Off, 10minute, 20minutes, 30minutes, 60minutes, 90minutes, 120 minutes, 240 minutes.

Disable TV sleep timer:

Select the Off on the screen, then close the TV sleep timer.

OSD Timer

Press **▲/▼** key select OSD Timer; then press **◀/▶** key to adjust the menu display time (Off, 5 Seconds, 15 Seconds, 30 Seconds, 60 Seconds).

Auto Standby

Press **▲/▼** key select Auto Standby; then press **◀/▶** key to adjust the time: Off, 3hours, 4hours, 5hours.

Time Zone

Press **▲/▼** key select Time Zone; then press **◀/▶** key to adjust the time zone of different country.

LOCK

System/Hotel Lock

Select turn on/off lock system. Block program option can work when it is on state (The default password: 0000).

Set Password

Set new password.

Channel Lock

Press **—** key to lock the programme in the channel list. You need input the right password to view the programme when it is locked.

Parental Guidance

Adjust the programme blocking level, this function help Parents block unsuitable channel for their child age.

Key Lock

Select the Key Lock off, Partial, Full.

SETTING

General Settings

Language

Select a language for the TV system.

Audio Languages

Select the language for audio if the programme is available.

Subtitle Language

Select the subtitle language if the programme is available.

Hearing impaired

Select the Hearing impaired on or off.

PVR file system

Manage the USB device for the recording programme.

First time installation

When the TV was the first time installed, you can setup language, country,

environment, auto tuning.

Software Update (USB)

Upgrade software with the USB interface.

Reset TV

Resetting the TV will cause all the settings to return to factory default status.

HDMI CEC

Setup the HDMI CEC options.

Open source liscecse

PICTURE

Picture Setting

Press **MENU** key to show main menu, select Picture icon and press **OK** key to enter.

Picture Mode: press **◀/▶** key to set the picture display mode such as: Personal, Economy, Dynamic, Standard, Mild, Movie.

Contrast: press **◀/▶** key to adjust contrast value of picture (0~100).

Brightness: press **◀/▶** key to adjust brightness value of picture (0~100).

Saturation: press **◀/▶** key to adjust saturation value of picture (0~100).

Sharpness: press **◀/▶** key to adjust sharpness value of picture (0~100).

Color Temp: press **◀/▶** key to set colour temperature of picture such as: Cool, Standard, Warm.

Aspect Ratio: press **◀/▶** key to set aspect ratio of picture such as: 16:9, Zoom 1, Zoom 2, Auto 4:3.

Noise Reduction: press **◀/▶** key to set noise reduction of picture such as: Off, on.

SOUND

Sound Setting

Press **MENU** key to show main menu, select Sound icon and press **OK** key to enter.

Sound Mode: press ◀/▶ key to set the sound display mode such as: Personal, Standard, Sports, Music, Movie.

Treble: press ◀/▶ key to adjust treble value of sound (0~100).

Bass: press ◀/▶ key to adjust bass value of sound (0~100).

Balance: press ◀/▶ key to adjust balance value of sound (-50~50).

Auto Volume Level: press ◀/▶ key to turn on or off the auto volume level.

Surround Sound: press ◀/▶ key to select on or off Surround Sound.

Audio Out Format: press ◀/▶ key to select the SPDIF Mode of sound, such as: Auto, Off, PCM.

Audio Description: press ◀/▶ key to turn on or off the AD Switch.

MULTIMEDIA

From a USB connection

Insert a USB device, press **MENU** key to display menu, select MULTIMEDIA, and press **OK** key to enter multimedia player.

In the multimedia menu, press ▲/▼ key to select category, and press **OK** key enter.

You can press ◀/▶/▲/▼ key to select the files in the File folder, then press

START(▶) key on the remote control to play the files.

Note: Press **SOURCE** or **TV EXIT** to exit **MULTIMEDIA**

6 Product information

Product information is subject to change without notice. For detailed product information, please visit www.philips.com/support.

Display resolutions

Computer Formats

- Resolution - refresh rate:
 - 640 × 480 - 60Hz
 - 800 × 600 - 60Hz
 - 1024 × 768 - 60Hz
 - 1360 × 768 - 60Hz
 - 1920 × 1080 - 60Hz

Video Formats

- Resolution - refresh rate:
 - 480i - 60Hz
 - 480p - 60Hz
 - 576i - 50Hz
 - 576p - 50Hz
 - 720p - 50Hz, 60Hz
 - 1080i - 50Hz, 60Hz
 - 1080p - 50Hz, 60Hz.

Multimedia

- Supported storage device: USB (only FAT or FAT 32 USB storage devices are supported.)

Sound power

- 43" : 8W × 2

Inherent resolution

- 43" : 1920 × 1080

Tuner / Reception / Transmission

- Aerial input: 75ohm coaxial (IEC75)
- Supported Systems:
 - ATV: PAL, SECAM.
 - DTV: DVB-C/T/T2.

Remote Control

- Batteries: 2 × AAA

Power Supply

- Main Power Supply:
 - 100-240V~, 50/60Hz
- Standby Energy Consumption :
 - ≤0.5W
- Environment Temperature: 5- 40 °C
- Power consumption:
 - 43" : 75W

Supported TV mounts

To mount the TV, please purchase a Philips TV mount or any TV mount compliant with the VESA standard. To prevent damage to cables and connectors, be sure to leave a clearance gap of at least 2.2 inches or 5.5cm between the back of the TV to the wall.



Warning

- Please follow all instructions provided with the TV mount. TP Vision Europe B.V. bears no responsibility for improper TV mounting that results in accident, injury or damage.

Model No.	Required Pixel Pitch (mm)	Required Mounting Screws
43" :	400 × 200	4 × M6

VESA screw hole

a: Depth of the top VESA screw hole

b: Depth of the bottom VESA screw hole

Model No.	a-b (mm)
43"	22



Note

- The screw length depends on wall bracket.

such offer is requested by the respective licenses. This offer is valid up to three years after product purchase to anyone in receipt of this information. To obtain the source code, please write in English to...

open.source@tpvision.com

2017 © TP Vision Europe B.V.

All rights reserved.

Open source license

About open source license

Acknowledgements and License Texts for any open source software used in this Philips TV.

This is a document describing the distribution of the source code used on the Philips TV, which fall either under the GNU General Public License (the GPL), or the GNU Lesser General Public License (the LGPL), or any other open source license. Instructions to obtain source code for this software can be found in the user manual.

PHILIPS MAKES NO WARRANTIES WHATSOEVER, EITHER EXPRESS OR IMPLIED, INCLUDING ANY WARRANTIES OF MERCHANTABILITY OR FITNESS FOR A PARTICULAR PURPOSE, REGARDING THIS SOFTWARE. Philips offers no support for this software. The preceding does not affect your warranties and statutory rights regarding any Philips product(s) you purchased. It only applies to this source code made available to you.

This TV contains open source software. TP Vision Europe B.V. hereby offers to deliver, upon request, a copy of the complete corresponding source code for the copyrighted open source software packages used in this product for which

7 Troubleshooting

This section covers common problems and their accompanying solutions.

General issues

The TV cannot be switched on:

- Disconnect the power cable from the power outlet. Wait for one minute before reconnecting it.
- Check that the power cable is securely connected.

The remote control is not working properly:

- Check that the remote control batteries are correctly inserted according to the +/- orientation.
- Replace the remote control batteries if they are flat or weak.
- Clean the remote control and TV sensor lens.

The TV menu is in the wrong language.

- Change the TV menu to your preferred language.

When turning the TV On/Off or to Standby, you hear a creaking sound from the TV chassis:

- No action is required. The creaking sound comes from the normal expansion and contraction of the TV as it cools down and warms up. This does not impact its performance.

Channel issues

Previously installed channels do not appear in the channel list:

- Check that the correct channel list is selected.

Picture issues

The TV is on, but there is no picture:

- Check that the antenna is properly connected to the TV.
- Check that the correct device is selected as the TV source.

There is sound but no picture:

- Check that the picture settings are correctly set.

Poor TV reception from the antenna connection:

- Check that the antenna is properly connected to the TV.
- Loudspeakers, unearthed audio devices, neon lights, high buildings and other large objects can influence reception quality. If possible, try to improve the reception quality by changing the antenna direction or moving devices away from the TV.
- If the reception on one particular channel is poor, please fine tune this channel.

There is poor picture quality from connected devices:

- Check that the devices are connected properly.
- Check that the picture settings are correctly set.

The picture does not fit the screen; it is too big or too small:

- Try using a different picture format.

The picture position is incorrect:

- Picture signals from some devices may not fit the screen correctly. Please check the signal output of the device.

Sound issues

The pictures are showing but sound quality is poor:

- Check that all cables are properly connected.
- Check that the volume is not set to 0.
- Check that the sound is not muted.
- Check that the sound settings are correctly set.

The pictures are showing but sound comes from one speaker only:

- Verify that sound balance is set to the centre.

HDMI connection issues

There are problems with HDMI devices:

- Please note that HDCP (High-bandwidth Digital Content Protection) support can delay the time taken for a TV to display content from a HDMI device.
- If the TV does not recognise the HDMI device and no picture is displayed, please try switching the signal source to another device before switching it back again.
- If there are intermittent sound disruptions, please check that output settings from the HDMI device are correct.

Computer connection issues

The computer display on the TV is not stable:

- Check that your PC uses the supported resolution and refresh rate.
- Set the TV picture format to unscaled.

Contact us

If you cannot resolve your problem, please refer to the FAQs for this model at

www.philips.com/support.

If the problem remains unresolved, please contact your local Philips Customer Service Centre.



Warning

- Do not attempt to repair the TV yourself. This may cause severe injury, irreparable damage to your TV or void your warranty.



Note

- Please make a note of your TV model and serial number before you contact Philips Customer Service Centre. These numbers are printed on the back/bottom of the TV and on the packaging.

8 Terms of warranty

This product is meant for sale in the European Union. Should you have bought this product elsewhere, please check with your point of purchase about the local warranty conditions.

- The terms of warranty can be downloaded from the Philips support website.
 - Never attempt to repair the TV yourself because it gives risk of injury, damage to the TV or void of warranty!
 - Use the TV and accessories only as intended by the manufacturer.
 - The caution sign printed on the back of the TV indicates risk of electric shock. Never remove the TV cover. Always contact Philips TV Customer Care for service or repairs.
-
- Any operation expressly prohibited in this manual, or any adjustments and assembly procedures not recommended or authorised in this manual shall void the warranty.

Consumer Care

Visit www.philips.com/support for online chat, user manuals, local warranty conditions, FAQs, and the TV support forum. For questions about installation, usage and troubleshooting, call your nearest Philips Consumer Care center.

☎ **020 79 49 03 19**
(5p/min BT landline)

This product was brought to the market by TP Vision Europe B.V. or one of its affiliates, further referred to in this document as TP Vision, which is the manufacturer of the product. TP Vision is the warrantor in relation to the TV with which this booklet was packaged. Philips and the Philips Shield Emblem are registered trademarks of Koninklijke Philips N.V. Specifications are subject

to change without notice.

TP Vision reserves the right to change products at any time without being obliged to adjust earlier supplies accordingly.

The written material packaged with the TV and the manual stored in the memory of the TV or downloaded from the Philips web site, are believed adequate for the intended use of the system. If the product is used for purposes other than those specified herein, TP Vision cannot guarantee the proper functioning and the safety of the product.

TP Vision cannot be held responsible for any errors in the content of this document nor for any problems as a result of the content in this document. Errors reported to TP Vision will be adapted and published on the Philips support website as soon as possible.

Pixel characteristics

This LCD/LED product has a high number of color pixels. Although it has effective pixels of 99.999% or more, black dots or bright points of light (red, green or blue) may appear constantly on the screen. This is a structural property of the display (within common industry standards) and is not a malfunction.

2016 © TP Vision Europe B.V.
All rights reserved.





© 2017 TP Vision Europe B.V.

All rights reserved.

Philips and the Philips' shield emblem are registered trademarks of Koninklijke Philips N.V. and are used under license from Koninklijke Philips N.V.

