

iTV



PHILIPS

Information for users in the UK (not applicable outside the UK)

Positioning the TV

For the best results, choose a position where light does not fall directly on the screen, and at some distance away from radiators or other sources of heat. Leave a space of at least 5 cm all around the TV for ventilation, making sure that curtains, cupboards etc. cannot obstruct the air flow through the ventilation apertures. The TV is intended for use in a domestic environment only and should never be operated or stored in excessively hot or humid atmospheres.

Interference

The Department of Trade and Industry operates a Radio Interference Investigation Service to help TV license holders improve reception of BBS and IBA programmes where they are being spoilt by interference.

If your dealer cannot help, ask at a main Post Office for the booklet "How to Improve Television and Radio Reception".

Mains Connection

Before connecting the TV to the mains, check that the mains supply voltage corresponds to the voltage printed on the type plate on the rear panel of the TV. If the mains voltage is different, consult your dealer.

Important

Should it become necessary to replace the mains fuse, this must be replaced with a fuse of the same value as indicated on the plug.

1. Remove fuse cover and fuse.
2. The replacement fuse must comply with BS 1362 and have the ASTA approval mark. If the fuse is lost, make contact with your retailer in order to verify the correct type.
3. Refit the fuse cover

In order to maintain conformity to the EMC directive, the mains plug on this product must not be removed.

Connecting the aerial

The aerial should be connected to the socket marked  at the back of the set. An inferior aerial is likely to result in a poor, perhaps unstable picture with ghost images and lack of contrast. Make-shift loft or set-top aerials are often inadequate. Your dealer will know from experience the most suitable type for your locality.

Should you wish to use the set in conjunction with other equipment, which connects to the aerial socket such as TV games, or a video camera it is recommended that these be connected via a combiner unit to avoid repeated connection and disconnection of the aerial plug.

Fitting the stand (if provided)

Use only the stand provided with the set, making sure that the fixings are properly tightened. A diagram showing how to assemble the stand is packed with the stand. Never use a make-shift stand, or legs fixed with woodscrews.

Introduction

Thank you for purchasing this television set.

This handbook has been designed to help you install and operate your TV set.

We strongly recommend that you read it thoroughly.

Access Code / Code d'accès / Zugangskennziffer / Codice di accesso / Código de acceso

When the set is in the **Standard** Security Mode, the Set-up Menu may be accessed either with an Institutional Set-up Remote Control, or with a guest remote control (like the RC2886) by pressing the following Remote Control keys in sequence: **3 1 9 7 5 3 Mute**

Care of the screen

Do not touch, push or rub or strike the screen with anything hard as this may scratch, mar or damage the screen permanently. Do not rub with dust clothes with chemical treatment. Do not touch the surface with bare hands or greasy cloth (some cosmetics are detrimental to the screen). Unplug the TV before cleaning the screen. When the surface becomes dusty, please wipe gently with absorbent cotton or other soft materials like chamois soaks. Do not use acetone, toluene and alcohol because they cause chemical damage.

Do not use liquid cleaners or aerosol cleaners. Wipe off saliva or water drops as soon as possible. Their long time contact with the screen causes deformations and colour fading.

Environmental

- Your television contains material that can be recycled and reused by specialized companies. Please find out about local regulations on the disposal of your old television set. Pay particular attention to the disposal of exhausted batteries.
- Your television consumes energy in the stand-by mode. Energy consumption contributes to air and water pollution. We advise you to switch off your television overnight instead of leaving it in stand-by mode.



The packaging of this product is intended to be recycled. Apply to the local authorities for correct disposal.



Disposal of your old product.

Your product is designed and manufactured with high quality materials and components, which can be recycled and reused. When this crossed-out wheeled bin symbol is attached to a product it means the product is covered by the European Directive 22002/96/EC. Please find out more about the separate collection system for electrical and electronic products in your local neighbourhood.

Please act according to your local rules and do not dispose of your old products with your normal household waste. The correct disposal of your old product will help prevent potential negative consequences for the environment and human health.

Preparation

Wall mounting instructions/Table stand

According to the type of TV you've purchased a wall mount bracket and/or stand may be supplied. To mount the supplied stand and/or wall mount bracket, refer to separate instructions. Make sure that the wall mount is fixed securely so that it meets safety standards.

Make sure that air can circulate freely through the ventilation slots

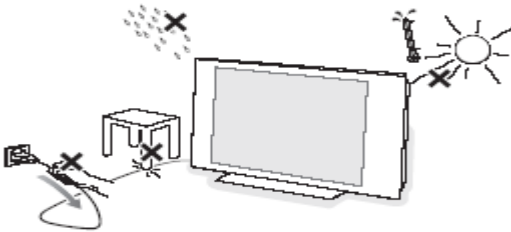

To prevent any unsafe situations, no naked flame sources, such as lighted candles, should be placed on or in the vicinity. Avoid heat, direct sunlight and exposure to rain or water. The equipment shall not be exposed to dripping or splashing and no objects filled with liquids, such as vases, shall be placed on it. Insert the aerial plug firmly into the aerial socket at the bottom of the TV.

Connecting the Mains

Insert the mains plug into the wall socket and switch on. Please refer to the label on the back of the television for the correct operating voltage.

Installing the remote control

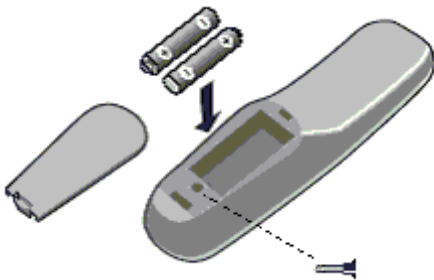

- Remove the cover at the back of the remote control.
- Insert the correct type and size batteries into the compartment making sure they are the right way around.
- You can secure your batteries by fastening an appropriate screw into the hole of the battery cover.

Switch the TV on:

Press the power switch  on the TV. An indicator on the front of the TV lights up and the screen comes on. If the TV is in standby mode (red indicator), press the **-TV+** keys on the remote control.

To use the menus

Accessing the Set-up Menu

When the set is in the High Security Mode, the Setup menu can be accessed only with an Institutional Set-up Remote Control (RG4172BK or RC2573).

When the set is in the Standard Security Mode, the Set-up Menu may be accessed either with an Institutional Set-up Remote Control, or with a guest remote control (like the RC2886) using an authorized access code.



RG4172BK

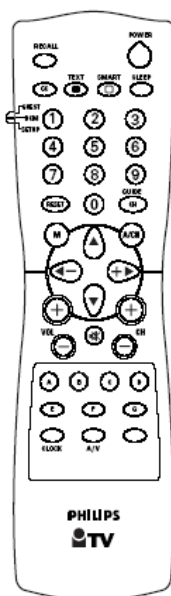

RC 2573

Navigation

The current menu item can be selected by means of the cursor up and cursor down keys. Submenus can be accessed from menu items with a ">" symbol pressing the cursor right key.

- To exit any menu press "Menu" button
- Select "YES" to activate/enable a setting, "NO" to deactivate/disable.
- TELEVISION up/down, INFO up/down, PAY-TV up/down and RADIO up/down are active in menu mode and the television reacts the same way as in TV mode.

Setup menu items

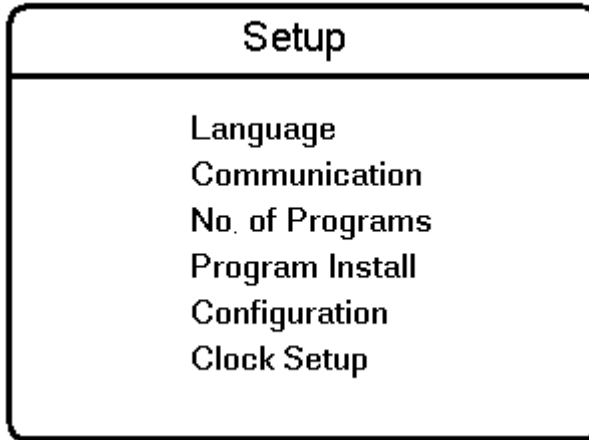

- **Language:** Select the language of the installation menu. Options are "ENGLISH", "ITALIANO", "DEUTSCH", and "FRANCAIS".
- **Communication:** The Communication menu is required to enable interactive applications. For more information, consult the respective application notes. For stand-alone applications select "OFF".
- **No. of Programs:** This sub menu allows setting the number of Television, PAY-TV, Radio and Info programs. The overall maximum number of programs is 125.
- **Program Install:** In the Program Install sub-menu, program settings can be set.
- **Configuration:** In the Configuration menu, various settings and features of the TV can be adjusted.
- **Clock Setup:** The Clock set-up menu can be entered from this menu item (*this menu option is only available on certain LCD TV models*).

Program Installation

In the Program Installation sub-menu, program settings can be set. When this menu is open, all the protections are inactive.

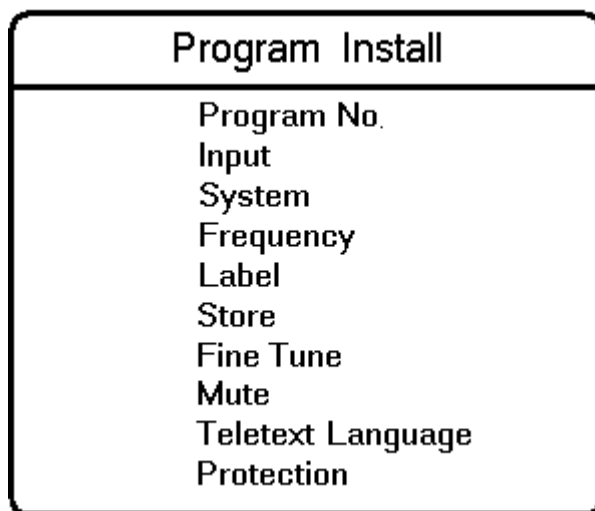

- Program No.:** The program type can be selected with the cursor left/right buttons. These buttons will toggle between all available types: "TV", "INFO", "PAYTV" and "RADIO".
 If the program number of a certain type is 0, the corresponding type is not displayed. In order to display a program number of the above-mentioned types, always enter two numbers, for example: "01" for TV1 or digit "1" and up/down cursor.
- Input:** The "Input" menu item selects the desired input source that will be assigned to the program. Possible values are TUNER, AV1, AV2, S-VIDEO, SIDE AV, SIDE S-VIDEO, CARD-CVBS, CARD-YC, EXT4, CARD-EXT4, HDMI1 and HDMI2. Some input sources may not be available on certain sets (see accompanying table).

<u>Model / Input</u>	<u>AV1</u>	<u>AV2</u>	<u>Side AV</u>	<u>Side S-Video</u>	<u>EXT4</u>	<u>HDMI</u>
26HF5444	Scart1	Scart2 CVBS	AV-In	S-Video In	YPbPr	HDMI1 / HDMI2
26HF7874	Scart1	Scart2 CVBS	AV-In	S-Video In	YPbPr	HDMI1 / HDMI2
32HF7444	Scart1	Scart2 CVBS	AV-In	S-Video In	YPbPr	HDMI1 / HDMI2
32HF7874	Scart1	Scart2 CVBS	AV-In	S-Video In	YPbPr	HDMI1 / HDMI2
37HF7444	Scart1	Scart2 CVBS	Video In	S-Video In	YPbPr	HDMI1 / HDMI2

Note: When a SmartCard XPress Box is used, it is usually connected to Scart1.

- **System:** WEST EU (PAL/SECAM-BG), EAST EU (PAL/SECAM-DK), UK (PAL-I), and FRANCE (SECAM-L/L').
- **Frequency:** Digits can be entered for a frequency in MHz. Right cursor starts an auto search; during frequency entry the digits not yet entered are displayed as dashes "-". Enter "0" for frequencies below 100 MHz.
- **Label:** This menu item will be used to add a label/name for each program.
 - Pressing the left/right buttons you may enter or exit the label field; pressing the up/down cursor you may insert alphanumeric characters.
 - Pressing M (Menu button) you may exit the Label Menu item.
- **Store:** The present program information is stored after pressing the cursor left/right button. Press Menu to exit without storing.
- **Fine Tune:** Using the "control left/right" commands starts fine-tuning.
- **Mute:** This item enables/disables picture and sound for the particular channel.
 - NONE: normal picture and sound enabled
 - VIDEO: picture is blanked for this channel (e.g. radio channel)
 - AUDIO: sound is muted for this channel (e.g. information channel)
- **Teletext Language:** This menu enables the user to select the Teletext character set to be used for the selected channel. With cursor left/right you can select a letter corresponding to the different language clusters.
 - "WEST EU": Pan European (Latin) / West option
 - "EAST EU": Pan European (Latin) / East option (*this menu option is only available on certain LCD TV models*)
 - "GREEK": Greek
 - "CYRILLIC": Cyrillic (*this menu option is only available on certain LCD TV models*)
- **Protection:** This function indicates whether the selected program has a protection or not. With the cursor left/right keys the protection can toggle between "YES" and "NO".

Configuration

In the Configuration menu, various settings and features of the TV can be adjusted.

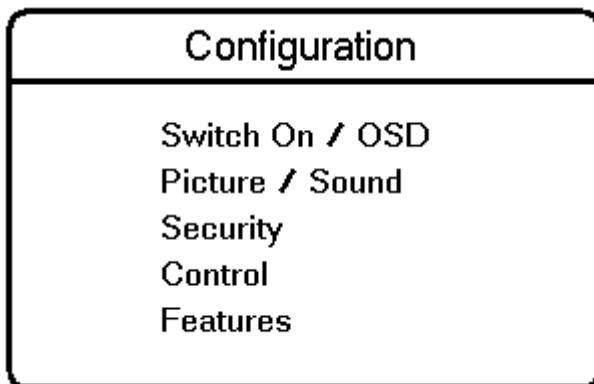

- **Switch On/OSD:** In this sub-menu the behavior of the TV after switching on and the behavior of the On Screen Display can be selected.
- **Picture/Sound:** In this sub-menu, the Picture and Sound settings of the TV can be selected.
- **Security:** In this sub-menu, the Security settings of the TV can be configured.
- **Control:** In this sub-menu, the Control settings of the TV can be configured.
- **Features:** In this sub-menu, advanced features of the TV can be accessed.

Switch On / OSD

In this sub menu the behavior of the TV after switching on and the behavior of the On Screen Display can be selected.

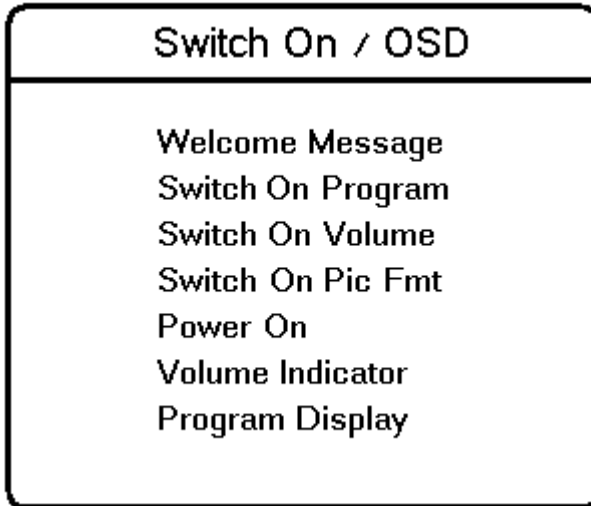

- **Welcome Message:** Press Cursor Left/Right to display Welcome message entry menu:

- Display
- Line 1
- Line 2
- Clear

With the Cursor Up/Down you can set the message characters.

- **Switch On Program:** This item sets the television's program at switch on.

- **Switch On Volume:** This item sets the television's volume at switch on. Use the Right/Left Cursor buttons to adjust.
- **Switch On Pic Fmt:** This item sets the television's Picture Format at switch on. Use the Right/Left Cursor buttons to adjust.
- **Power On:** The Power On menu function defines the behavior of the television whenever AC Power is applied. The valid states are "ON", "FORCED ON", "LAST STATUS" and "STANDBY".
 - When "ON" & "FORCED ON", the television can only be switched OFF by means of the main switch or a set-up remote control or by ESP function (Energy Saving Programmability controls the maximum continuous viewing time allowed by the control system).
 - When "LAST STATUS", the television switches on the previous status, ON or Stand-by.
 - When "STANDBY", the television always switches on in Stand-by.
- **Volume Indicator:** To display volume indicator when adjusting volume, select "YES". Select "NO" to hide the volume indicator.
- **Program Display:** Program Display values can be: **Number, Label, All, None.**

Picture and Sound settings

In this sub menu, the Picture and Sound settings of the TV can be selected.

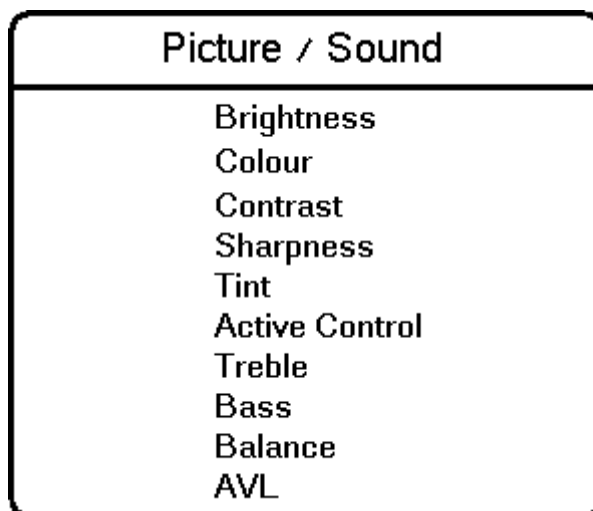

- **Brightness:** This changes picture brilliance.
- **Colour:** This changes the intensity of the colour.
- **Contrast:** This changes the difference between the light and dark tones.
- **Sharpness:** This changes the picture definition.
- **Tint:** Adjusts the picture to obtain natural skin tones.
- **Active Control:** Active Control optimises the quality of the picture according to the quality of reception (*this menu option is only available on certain LCD TV models*).
- **Treble/Bass:** This adjusts the level of treble and bass effects on the TV's sound output.
- **Balance:** This balances the sound on the left and right speakers.
- **AVL (Automatic Volume Leveller):** This is used to limit increases in sound, especially on programme change or advertising slots.

Security settings

In this sub menu, the Security settings of the TV can be configured.

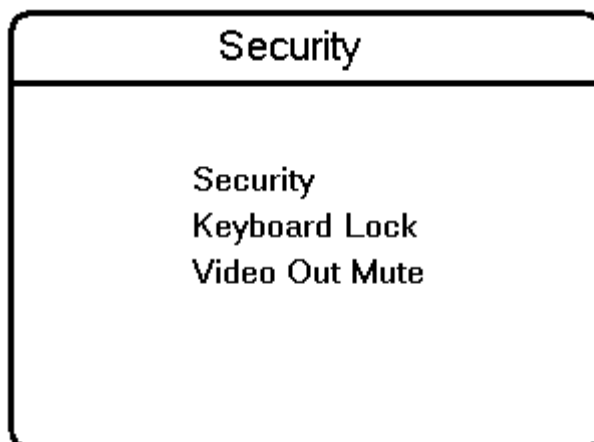

- **Security:** The menu function “SECURITY” allows the user to select one of two states “HIGH” or “STANDARD”. The default is “STANDARD”.
 - While the set is in the Security **High** Mode the Set-up menu can only be accessed with an Institutional Set-up Remote Control.
 - While the set is in the Security **Standard** Mode, the Set-up Menu may be accessed either with an Institutional Set-up Remote Control, or with a guest remote control using an authorized access code.
- **Keyboard Lock:** The Keyboard Lockout menu function disables the television’s local keyboard for volume and program control.
- **Video Out Mute:** This option allows the user to mute Video outputs from the TV set, to prevent unauthorized copying of Video content.

Control settings

In this sub menu, the Control settings of the TV can be configured.

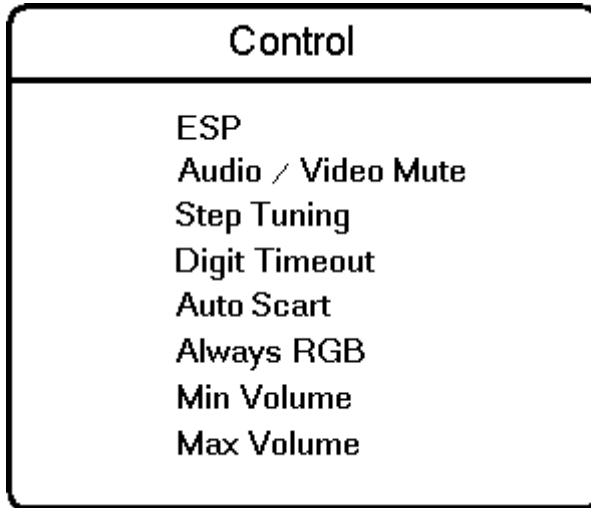

- **ESP:** Energy Saving Programmability Mode (ESP) controls the maximum continuous viewing time allowed by the control system. The ESP Menu function is shown as "ESP", and its valid values are 00 - 99 (in hours). 00 value means OFF.
- **Audio/Video Mute:** The Audio/Video Mute function determines whether the video should be blanked and the audio should be muted if the currently tuned channel has no signal.
- **Step Tuning:** If YES, TV programs (1 to 9) are tuned immediately when a digit is pressed. If NO, tuning is performed only after the dash disappears.
- **Digit Timeout:** This is the time-out to enter the second digit for TV program 10 onwards.
- **Auto Scart:** Enable/ disable automatic switching to external SCART source.
- **Always RGB:** This item allows RGB on the AV connectors to be enabled or disabled.
- **Min Volume:** This item sets the limit for minimum volume allowed for the television set. Use right/left cursor to adjust.
- **Max Volume:** This item sets the limit for the maximum volume allowed for the television set. Use right/left cursor to adjust.

Features Settings

In this sub menu, the Features settings of the TV can be configured. This includes the Picture-in-Picture (PIP) settings and digital audio settings.

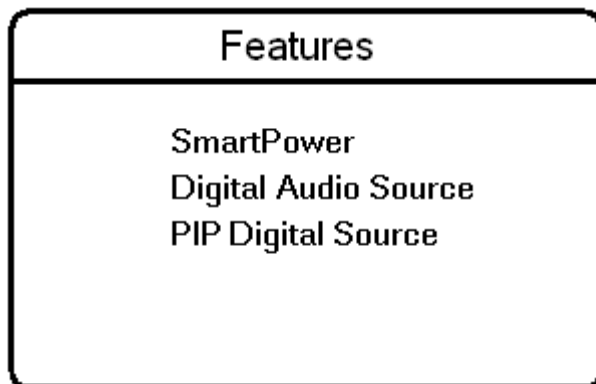

- **SmartPower:** Configures the SmartPower energy savings levels. The options are:
 - **OFF:** Maximum light output, and optimized for brightly-lit areas.
 - **LOW:** Maximum dynamic contrast combined with moderate energy saving. Optimized for high quality video content. (Default setting on TV)
 - **MEDIUM:** Optimal combination of significant energy savings and picture performance for most circumstances.
 - **HIGH:** Maximum energy savings. Optimized for reduced ambient light conditions, radio channels, music programs, and still pictures (example: Welcome screen)

Note: SmartPower is disabled for HDMI inputs and PIP modes.

- **Digital Audio Source:** Sets the default (Digital) Audio source in digital mode (full screen or PIP). The options are HDMI or DVI.
- **PIP Digital Source:** Sets the default Digital source HDMI when PIP is activated while viewing an analogue source. The options are HDMI1, HDMI2, and OFF.

Clock setup

The Clock set-up menu can be entered from this menu item (*this menu option is only available on certain LCD TV models*).

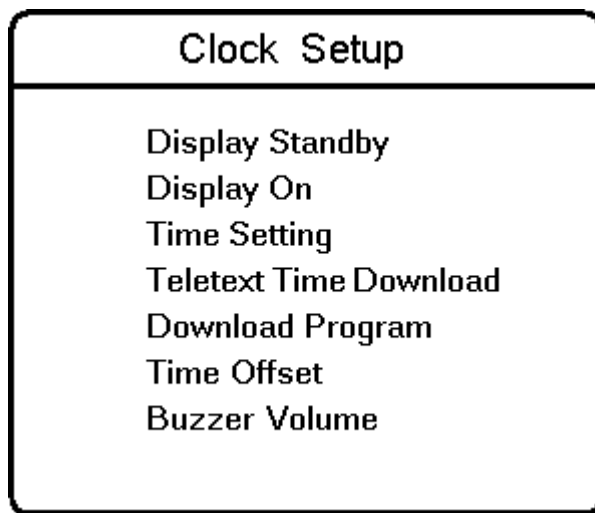

- **Display Standby:** This menu item will be used to set the intensity of the clock display when the television is in standby mode.
- **Display On:** This menu item will be used to set the intensity of the clock when the television is in the ON mode.
- **Time Setting:** This menu item will be used to set the time for the clock.
- **Teletext Time Download:** This menu item is used to activate or deactivate the function for automatic time downloading by means of Teletext.
- **Download Program:** This menu item is used to select the channel from which to retrieve the correct time from the Teletext.
- **Time Offset:** This menu item is used to set the offset needed to adjust the time received from the Teletext channel to represent the current time in the current location.
- **Buzzer Volume:** This item sets the volume of the alarm buzzer. Use the right/left cursor to adjust.

Remote control keys

Alarm On (for sets with Clock display)

Activates the wake-up alarm. After a valid time (0:00 to 23:59) is entered, the "Wake up Alarm" icon on the clock display will be visible.

+ Pay TV -

To move up or down a Pay TV channel.

Alarm Off (for sets with Clock display)

Deactivates the wake-up alarm. The "Wake-up Alarm" icon on the clock display will disappear.

Menu

To call up or exit the menus.

+ Vol -

To adjust the volume.

Mute

Interrupt the sound or restore it.

0/9 Digit keys

To select a TV channel. For a two digit programme number, enter the second digit before the dash appears.

Teletext

Standby

Press to switch the TV off.

+ Info -

To move up or down an Info channel.

+ Radio -

To move up or down a Radio channel.

Smart Keys

To select predefined picture and sound settings.

PIP

Activates the Picture In Picture (PIP) function. *(Available on certain TV models only)*

+ TV - Channel Selection

To move up or down a TV channel.

16:9 Formats

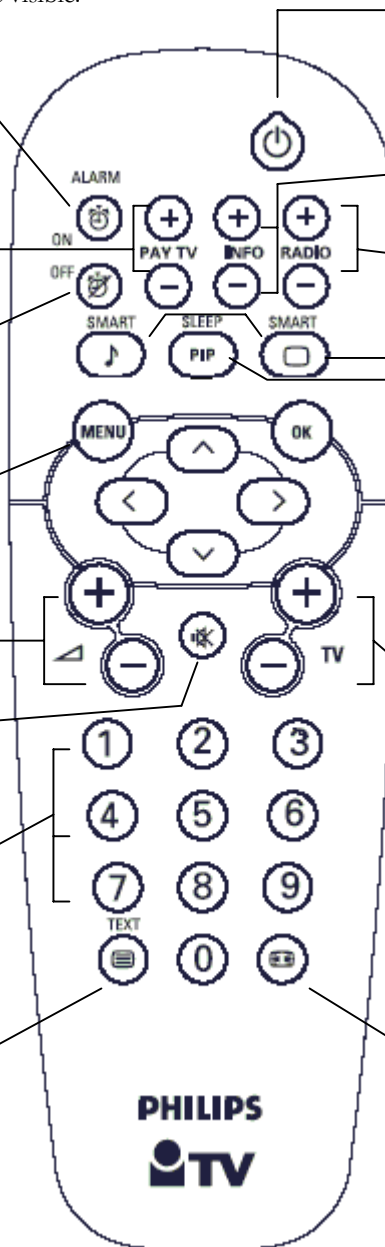

Teletext

Teletext is an information system broadcast by certain channels that can be consulted like a newspaper. It also offers access to subtitles for viewers with hearing problems or who are not familiar with the transmission language (cable networks, satellite channels, etc.).



Press:



To switch Teletext On/Off

In Teletext mode, press:



Go to a (3-digit) page number



Go to previous / next page



Go to previous / next page



Direct access to coloured page numbers indicated at the bottom of the screen

16:9 Formats

The pictures you receive may be transmitted in 16:9 format (wide screen) or 4:3 format (conventional screen). 16:9 pictures sometimes have a black band at the top and bottom of the screen (letterbox format). This function allows you to optimise the picture display on screen.

Using the different formats

Use the **16:9 Formats** button on the Remote Control to select the different modes: Auto Format, 4:3, Zoom 14:9, Zoom 16:9, Subtitle zoom, Fullscreen, Super Wide and Wide screen.

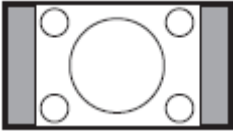

4:3

The picture is reproduced in 4:3 format and a black band is displayed on either side of the picture.

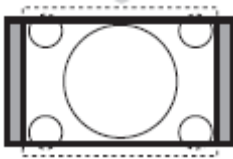

Zoom 14:9

The picture is enlarged to 14:9 format, a thin black band remains on both sides of the picture.

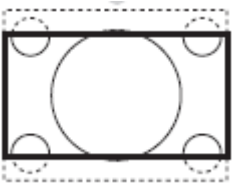

Zoom 16:9

The picture is enlarged to 16:9 format. This mode is recommended when displaying pictures that have black bands at the top and bottom (letterbox format).

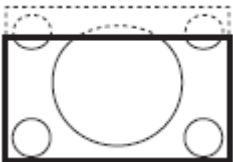

Subtitle Zoom

This mode is used to display 4:3 pictures using the full surface of the screen leaving the subtitles visible.



Super Wide

This mode is used to display 4:3 pictures using the full surface of the screen by enlarging the sides of the picture



Widescreen

This mode restores the correct proportions of pictures transmitted in 16:9 using the full screen display.

**Fullscreen**

This mode displays images in full screen.

**Auto Format**

This TV set is equipped with automatic switching which will select the correct screen format, provided the specific signals are transmitted with the programs.

Low battery check

Press the  key for approximately 5 seconds. The following text appears:

SERVICE

1 REMOTE BATTERY OK

If the word "LOW" appears instead of "OK", the batteries are low and must be replaced.

Keys on the TV

Should your remote be lost or broken you can still change some of the basic settings with the keys on the top/side of your TV.

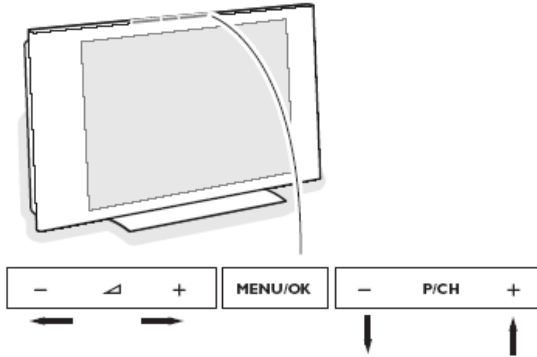

Keys on top of TV

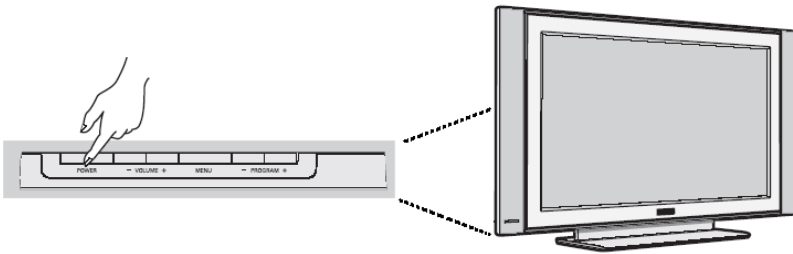

Keys on side of TV

Press:

- The **- Vol +** key to adjust the volume;
- The **- P/CH +** key to select the TV channels or source

Press the **MENU/OK** key to summon the main menu without the remote control (*not available on all TVs*). Use:

- The **- Vol +** key and the **- P/CH +** key to select menu items in the directions as shown;
- The **MENU/OK** key to remove the menu

Connecting the television set

This section provides information on the connectivity available for different LCD Television sets. Refer to the screen size that is relevant to your TV set.

26" & 32" LCD TVs

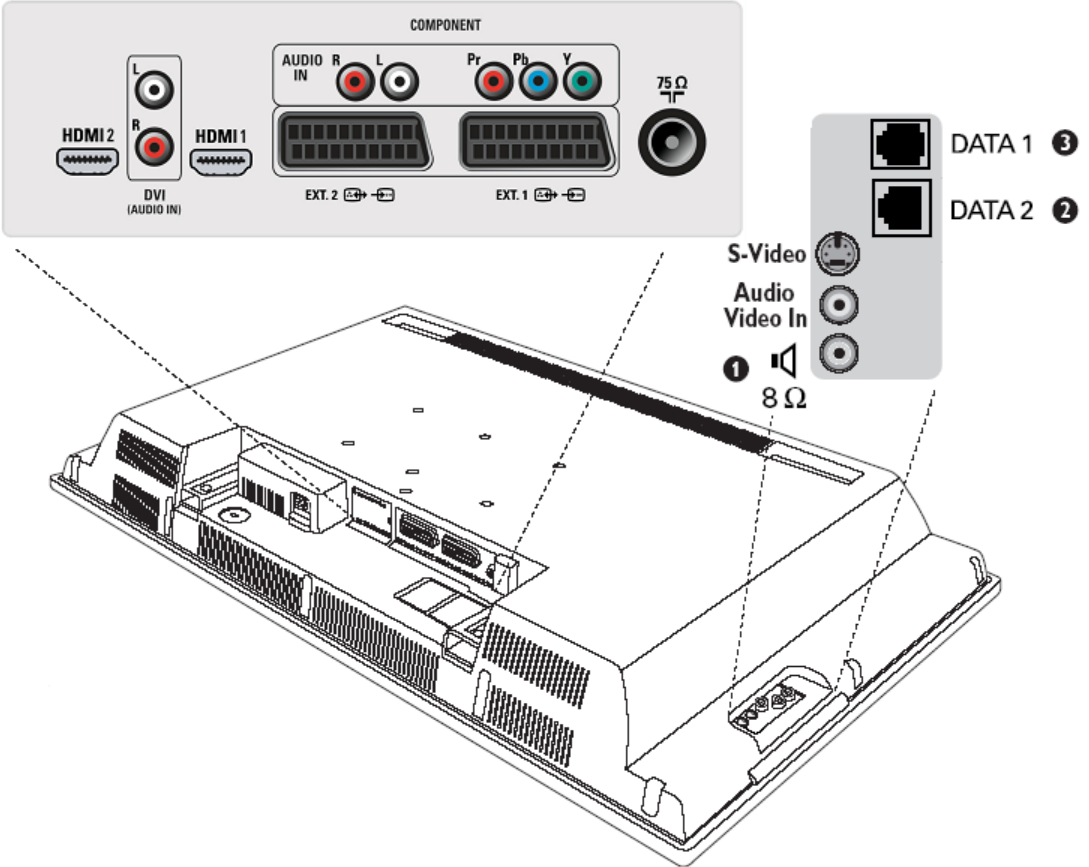

Connectors on the 26" & 32" LCD TVs

1. External Bathroom Speaker
2. Data 2 (RJ45) jack – for interactive connectivity purposes
3. Data 1 (RJ12) jack - for interactive connectivity purposes

37" TVs

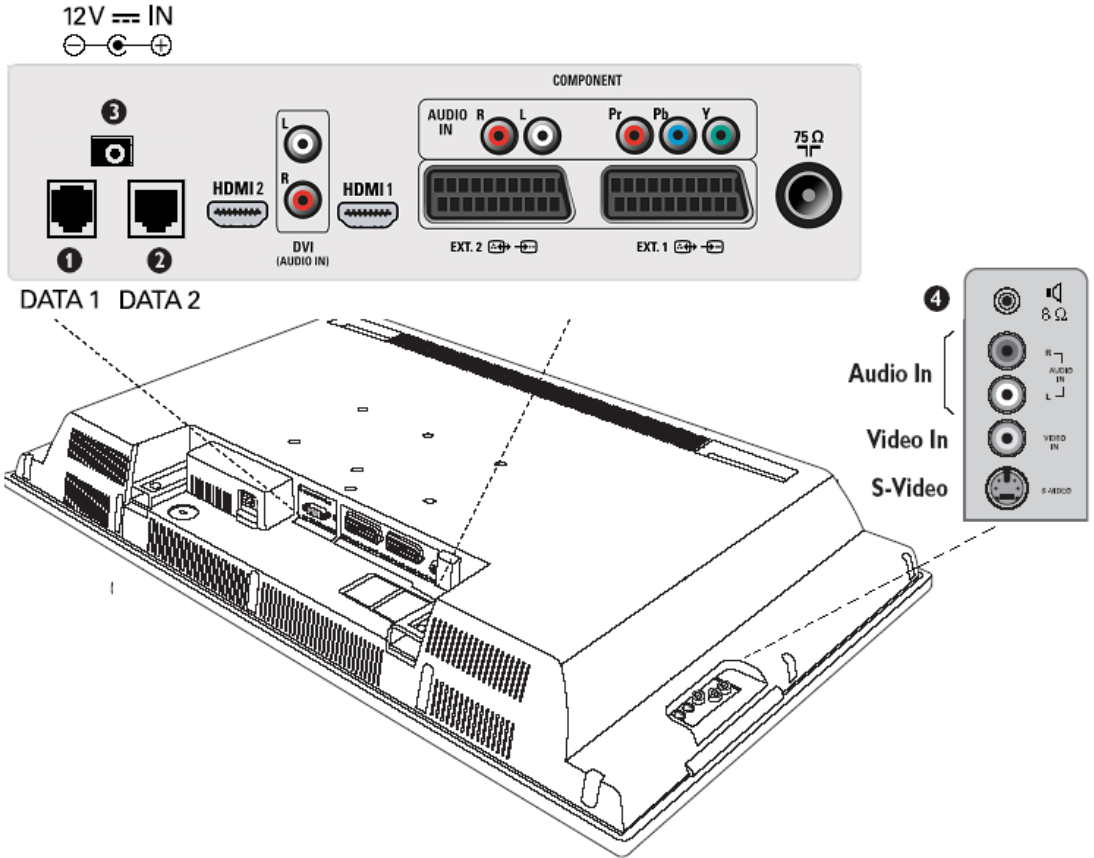

Connectors on the 37" TVs

1. Data 1 (RJ12) jack - for interactive connectivity purposes
2. Data 2 (RJ45) jack – for interactive connectivity purposes
3. 12V-In power DC jack
4. External Bathroom Speaker

Mounting the Television Stand

This section provides information on the connectivity available for different LCD Television sets. Refer to the screen size that is relevant to your TV set.

26" & 32" LCD TVs

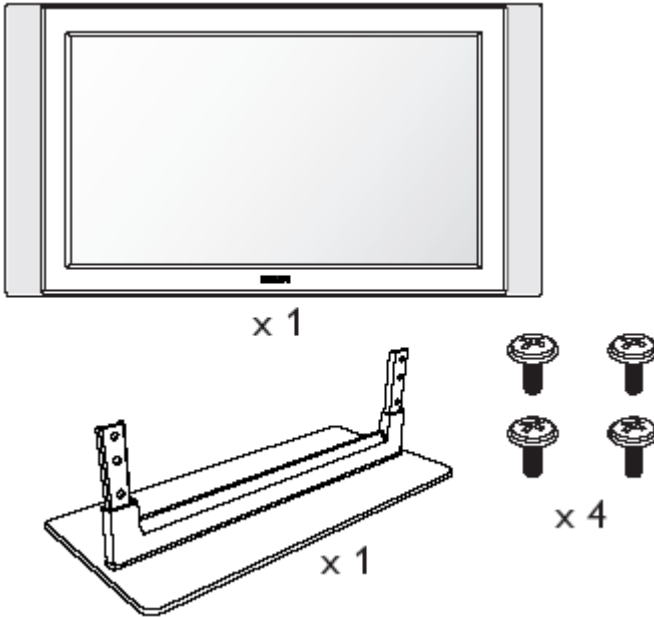

1

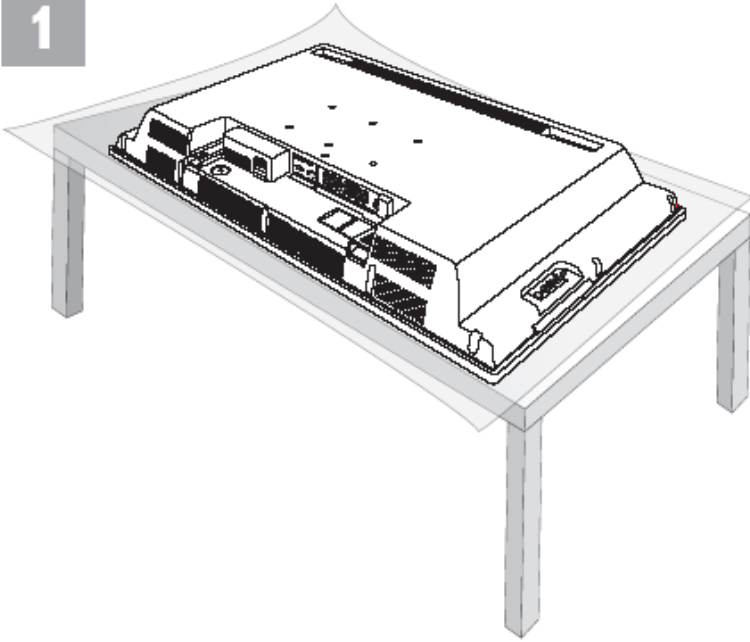

2

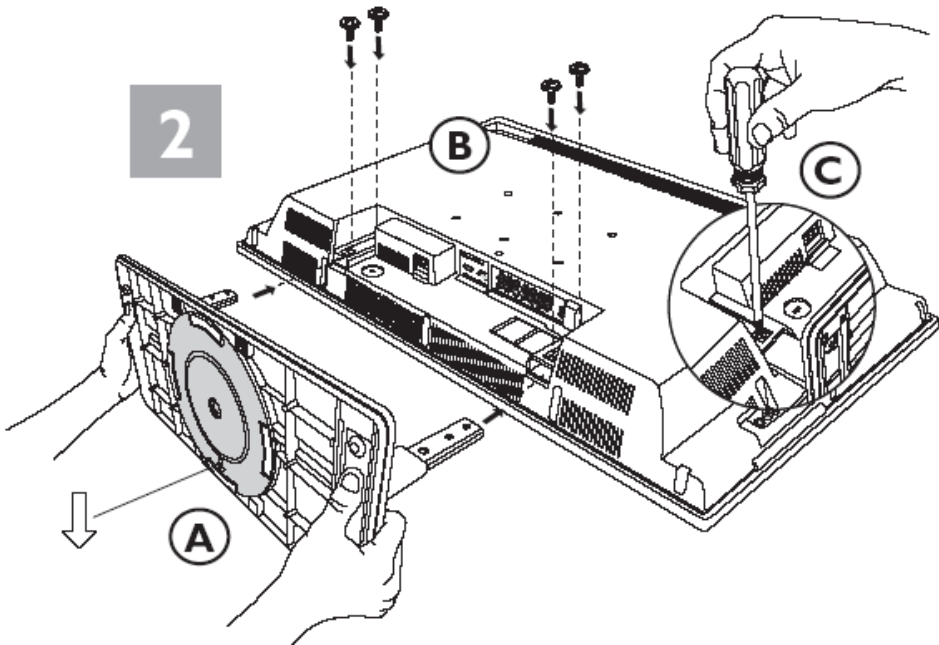

Specifications are subject to change without notice
Trademarks are property of Koninklijke Philips Electronics N.V. or their respective owners.
2005 © Koninklijke Philips Electronics N.V. All rights reserved.

www.philips.com



3139 125 36821