

Register your product and get support at  
[www.philips.com/TVsupport](http://www.philips.com/TVsupport)

32PHD5773/30

---

EN

User Manual

**PHILIPS**



# Contents

1	Notice	2	7	Installing channels	22
2	Important	3		Automatic channel search	22
3	TV Overview	6		Manually setting the channel	22
	Remote Control	6		Installing digital channels	22
	Use of remote controller	7	8	Network setting	23
4	Using TV	8		Turn on/off the smart TV	23
	Turn on the TV or switch to standby	8		Applications	23
	Switch channels	8		Network type	23
	To view the connected device(s)	9		Cable installation	23
	Adjust the TV volume	9		Wireless installation	24
5	Using More Feature of your TV	10	9	Connecting Devices	25
	Accessing the TV menu	10		Bottom Connectors	25
	Change languages	10		Side Connectors	26
	Rename the external devices	10		Using Philips EasyLink	26
	Reset signal source name	10		Media Center	27
	Change the picture settings	10		Multi-screen interaction	27
	Change the sound settings	12	10	Product Information	28
	Using EPG	13		Supported input signal formats	28
	Use of a timer	13		Multimedia	28
	Updating the TV software	14		Tuner / Reception / Transmission	28
	Changing TV preferences	15		Intrinsic Resolution/Sound power	28
	Watching TV demos	15		Remote Control	28
	Settings when reset to the factory settings	15		Power	28
6	Media playing	16		Dimensions and Weights	28
	Video formats supported by USB	16		Supported TV Mounts	29
	Audio formats supported by USB	17	11	Trouble Shooting	30
	Picture formats supported by USB	18		General TV issues	30
	Viewing photos and playing music and videos from a connected USB storage device.	18		TV channels have problems	30
	Enable the Family entertainments sharing to view photos and play music and videos	20		Picture problem	30
	Remove the USB storage device	21		Sound problem	31
				HDMI connection problem	31
				Computer connection problem	31
				Network connection problems	31
				Contact Us	31
			12	Index	32
				Software end user license agreement	32
				Disclaimer	35
				Open source	35

# 1 Notice

2019 © TPVision Europe B.V. All Right Is Reserved. Specifications may be subject to change without prior notice. All trademarks are the properties of Koninklijke Philips N.V or their respective owners. TPVision Europe B.V. reserves the right to change products at any time without the need to give response to early inventory adjustment. The content in this manual is suitable for this system. If the intended use of the product or its individual components or programs is not within the specified scope in this manual, you will have to ensure its effectiveness and applicability. TPVision Europe B.V. ensures that the manual itself does not infringe any patents of the United States. Disclaimer of Express or Implied Warranties TP Vision Europe B.V. is not responsible for any errors in the contents of this document, as well as any problems caused due to the content of this document. Errors reported to Philips will be applied and published on the Philips support website as soon as possible.

## Pixel Characteristics

This LCD product has a high color pixels. Although it has effective pixels of 99.999% or higher, the screen may appear black or have bright spots (red, green, or blue). This is the structural properties of the display (within the common industry standards), and is not a fault.

## Change components

Users are not allowed to change any components. Do not open or remove the back cover of the television and expose its inside. It must be repaired by Philips service centers and official repair shops. Otherwise, all declared or implied warranties will be invalidated.

Any operations specifically prohibited in this manual, any adjustments, or assembly procedures not recommended nor authorized in this manual are not within the scope of the warranty.

## Copyright

All other registered and unregistered trademarks are the property of their respective owners.

® Kensington and Micro Saver are the trademarks registered by ACCO World Corporation in the United States and already registered and being applied for in other countries/regions of the world. Part of the copyright of this software belongs to © The FreeType Project ([www.FreeType.org](http://www.FreeType.org)).



HDMI, HDMI logo and High-Definition Multimedia Interface are the trademarks or registered trademarks of HDMI Licensing LLC.



Manufactured under license from Dolby Laboratories. Dolby, Dolby audio and the double-D symbol are trademarks of Dolby Laboratories.

Philips and the Philips Shield Emblem are registered trademarks of Koninklijke Philips N.V. and are used under licence from Koninklijke Philips N.V.

## 2 Important

Before you start using the TV, please read and understand all instructions. If it is damaged due to failure to operate in accordance with the instructions, it is not covered by the warranty.

### Safety

Risk of electric shock or fire!!

- Do not expose the TV set to rain or water. Do not place any liquid containers (such as vases) next to the TV. If liquid is spilled onto the surface or inside of the TV set, please power off the TV. Please contact Philips' customer service center, do not use the TV set before check.
- Do not put the TV, remote control or batteries near flame or heat source that is not isolated, nor directly expose it to sunlight. To avoid heat impact, keep the TV, remote control and batteries away from candles or other sources of ignition.



- Please do not insert any articles into TV vents or other openings.
- When the TV set runs, make sure that the power cord does not become too tight. If the power cable becomes too tight, the plug may become loose and experience arcing.
- The power plug serves as the power disconnection device and should be easily operable.

Risk of short circuit or fire!

- Do not expose remote control or batteries to rain, water or hot environments.
- Please avoid subject the power plug to external forces. A loose power plug may cause arcing or fire.

Risk of TV damage or destruction!

- The TV with a weight greater than 25 kilograms or 55 pounds needs to be handled by two persons.
- Upon mounting the straight stand on TV, be sure to use the attached base. Make sure that the straight stand can firmly support the TV set. Please place your TV on the flat surface that can support the total weight of the TV set and the straight stand.
- Upon wall-mounting the TV set, please be sure to use the bracket that can support the weight of the TV set. Fix the bracket firmly on the wall that can support the total weight of both the TV set and the bracket. TP Vision Europe B.V. does not bear any responsibility for accidents, damage or destruction due to incorrect wall mounting of the TV set.
- Some parts of this product may contain glass elements. Please exercise caution to avoid personal injury or mechanical damage.

Causing the risk of injury of children!

Please observe the following precautions to avoid TV fall and child injury:

- Do not place the TV set on the surface covered by the fabrics or other materials easy to pull.
- Ensure that TV set does not have any part of it protruded beyond the edge of the surface.
- To place the TV set on the top of a tall item of furniture (bookcases, for example), please be sure to fix the furniture and the TV set onto the wall or the appropriate support point.
- Tell your children that climbing onto furniture to touch the TV set is prone to danger.

Risk of overheating!

- Do not place the TV set in a narrow space. The TV must be reserved a space of at least 4 inches or 10 cm around it to ventilate. Make sure not to allow curtains or other objects to cover the vents of the TV set.

If inadvertently, the TV set may be damaged!

- Before connecting the TV set to a power outlet, make sure the outlet voltage is consistent with the values printed on the back of the TV set. If both voltage values do not match, do not connect the TV to the power outlet.
- If your TV needs to be moved into the storage room for storage, first remove its base from the TV set. Do not place the TV set flat against its back when its base is not removed.

Risk of injury, fire or power cord damage!

- Do not put the TV or any objects upon the power line.
- For easy removal of the TV's power cord from the power outlet, a smooth and easy access to the power cord should always be kept.
- When pulling out the power cord, be sure to pull it from its plug part, and never pull the cable.
- Before the thunderstorm comes, please cut off the connection between the TV set, the power outlet and the antenna. During a thunderstorm, do not touch any part, power cord or antenna cable of the TV set!

Risk of hearing loss!

- Do not set the headset volume too high and don't use the headset for a long time.

Low temperatures

- If the TV set is transported at an ambient temperature below 5 °C or 41 °F, please wait for some time after the TV is taken out of the box until the TV's temperature returns to room temperature before it is connected to the power outlet.

fixed images, please reduce screen contrast and brightness to avoid screen damage.

- Remove the power cord before cleaning the TV.
- Use a slightly damp, soft cloth to clean the TV set and its frame. Do not use such substances as alcohol, chemicals or household cleaners to clean the TV set.
- If inadvertently, the TV screen may be damaged! Do not use items to touch, push, rub or strike the screen.
- To avoid warping and fading, please wipe the water droplets as soon as possible.



Note

Static images may cause permanent damage to the TV screen.

- Do not display static images on the LCD screen for more than two hours, as this can cause ghosting. To prevent ghosting, please reduce the brightness and contrast of the screen.
- Watching TV in 4:3 format for a long time may leave different marks on the left and right edges of the screen and the border of the image. Avoid using this mode for a long time.
- Long-term display of static images in videos and games or computers can cause some blurring and ghosting due to screen burn. Please correspondingly reduce the screen brightness and contrast when using the TV set in this way.

The ghosting, partial ghosting and other traces displayed on the TV screen for the above reasons are not within the scope of this warranty.

---

## Screen protection

- Please try to avoid rendering fixed images on the screen. A so-called fixed image means an image stays on the screen for a long time. For example, on-screen menus, black bars, and time display. If you must use

---

## Screen maintenance

Before using the TV, please read and understand all instructions. Any damages caused by failure

to comply with the above instructions are not covered under warranty.

- Avoid still images as much as possible. Still image is the image remained on the screen for a long time.
- Still images may cause permanent damages to the TV screen. Image ghosting, local afterimage, marks appearing on the TV screen due to the following causes are not warranted.
  - Do not display still images on the LCD TV screen for more than 2 hours, because this will cause screen image ghosting. In order to avoid this problem, you should reduce the brightness and contrast of the screen when displaying the still image.
  - Watching TV programs in 4:3 format for a long time may leave different marks in the left and right of the screen and the edges of the image. Please do not use this mode for a long time.
  - Displaying video games and computer still images for a long time may lead to local afterimage and screen image ghosting due to screen burn, so you should use lower brightness and contrast.
- Unplug the TV plug before cleaning.
- Wipe the TV set and its frame with a soft, dry cloth. Do not use such substances as alcohol, chemicals or household cleaners to clean the TV set.
- Caution damage to the TV screen! Do not use any object to touch, push and press, rub or strike the screen.
- In order to avoid warping and fading, please wipe off water droplets as soon as possible.

## Disposal of waste products and batteries



Your product is designed and manufactured using high-quality materials and components that can all be recycled and reused.



When accompanied by an attached cross recycling bin label, it means that the product applies to the European Guidelines (European Directive) 2012/19/EU.

Please obtain the related information about the local electronic and electrical product classification and collection systems. Please dispose it according to local regulations, and do not discard the waste product together with other general household wastes. Correct disposal of waste products helps to avoid the potential negative impact on human health and the environment.



Your product contains batteries in line with European standards (European Directive) 2006/66/EC, and shall not be discarded together with other household waste.

Please pay attention to the local regulations regarding classification and collection of batteries, because correct disposal of waste products can help avoid negative impact on both the environment and human health.

# 3 TV Overview

Congratulations for purchasing and using Philips product! In order to enjoy all the supports provided by Philips, please register your TV at [www.philips.com/TVsupport](http://www.philips.com/TVsupport)

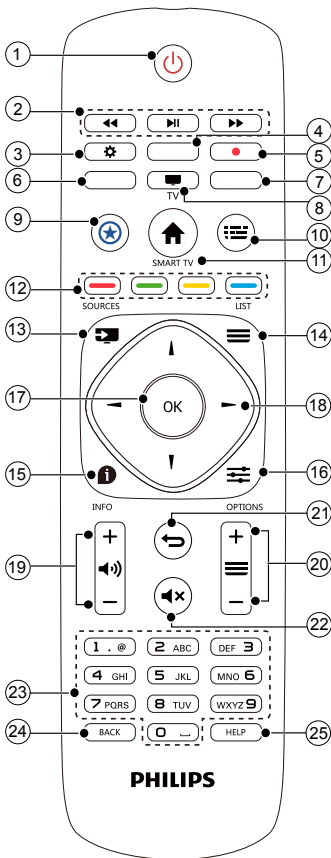

## Remote Control



- ① **⏻ (Standby-Power On)**  
Start the display, or enter the standby status.
- ② **Multimedia playback function button**

- ③ **⚙️ Setting**  
To open setting option.
- ④ ⑥ ⑦ **button**  
No function.
- ⑤ **Record button**  
No function.
- ⑧ **TV**  
Switch to TV source.
- ⑨ **Smart star**  
No function.
- ⑩ **EPG**  
To open EPG menu.
- ⑪ **SMART TV**  
To enter Smart TV main menu.
- ⑫   
Color buttons to select corresponding tasks or options.
- ⑬ **SOURCE(訊號源)**  
To open or close the signal source menu, and select the connected device.
- ⑭ **LIST(頻道列表)**  
To display the channel list.
- ⑮ **INFO(資訊)**  
To display the related information about the signals of the currently played screen.
- ⑯ **OPTIONS (應用選單)**  
To display the main screen of the menu.
- ⑰ **OK(確認) button**  
To confirm your input. To press 0~9 number keys and then press OK (確認) when selecting channels.
- ⑱ **▲▼◀▶ navigation button**  
Navigation button Select items from the menu.
- ⑲ **🔊 Volume +/- (音量+/-)**  
To adjust the volume size.
- ⑳ **⏮ Channel +/- (頻道+/-)**



- To select the next or previous channel.
- ②1  To return to the previous level/page.
- ②2  **Mute**  
To remain muted. Press the Volume +/- button again, to restore the original volume.
- ②3 **0-9 number keys**  
Press 0~9 number keys to enter a channel.
- ②4 **Back (返回)**  
Press this button to return to the previous channel.
- ②5 **Help (幫助)**  
To open user manual.

## Use of remote controller

When using the remote control, press and hold it near the TV set, and point it to the remote control sensor.

Ensure furniture, walls or other objects have not blocked the sight between the remote control and the TV set.

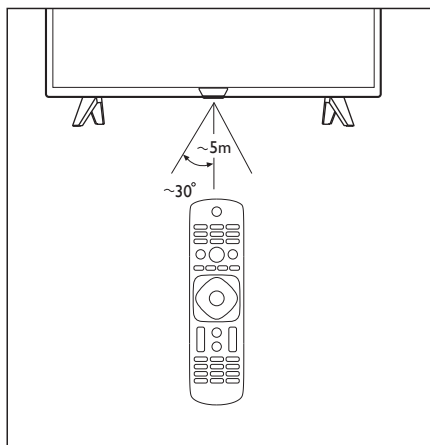

(Product shape may vary according to the different models, please refer to the actual models!)

# 4 Using TV

This section introduces the basic operations of the TV.

---

## Turn on the TV or switch to standby

---

### Turn TV on/off

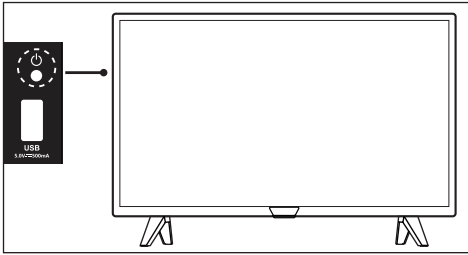

Press the button to turn on or turn off the TV on the left side behind the TV.

---

### Standby LED indicator

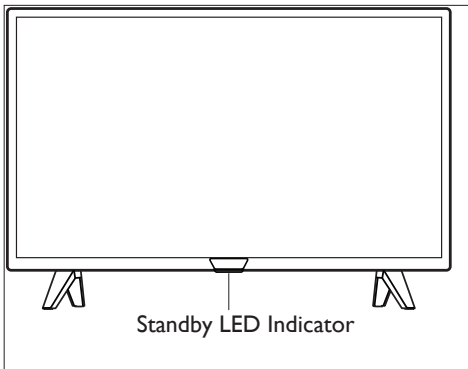

(Product shape may vary according to the different models, please refer to the actual models!)

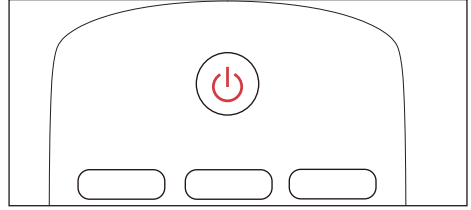

### Turn on the TV

- Plug the power cord into the AC power outlet.
  - ↳ If the standby LED indicator is red, press  (**Standby-Power on**) on the remote control.

### Switch to standby in the power-on status

- Press the  (**Standby-Power on**) on the remote control.
  - ↳ The standby indicator turns red.

### Tip

- Although the TV set does not consume much electricity in standby, but still consumes some; only unplugging the power plug can this product be completely powered off. If it is not used for a long time, unplug the power plug.

---

## Switch channels

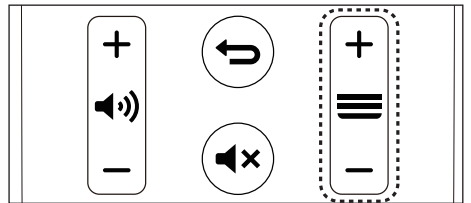

---

### Do not use the channel list to switch channels

- Press  **Channel +/-** (頻道+/-) on the remote control.

- Enter the channel number using the number keys on the remote control.
- Press **Back** (返回) button on the remote control to switch back to the previous channel.

## Using the channel list to switch channels

You can use the channel list to watch all the channels that can be received.

- 1 Press **OK** (確認).  
↳ To display the channel list.
- 2 Press **▲▼** to select channels.
- 3 Press **OK** (確認) to watch the selected channel.
- 4 Press **↶** to switch back to the channel you watched previously.

## To view the connected device(s)

### Note

- Before selecting an external signal source, please start up the external device.

## To use the **SOURCES** button

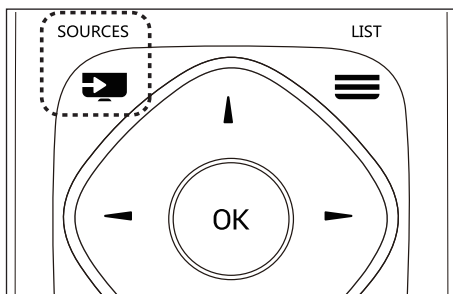

- 1 Press **SOURCES** (訊號源).  
↳ The signal source list appears.
- 2 Press **▲▼** to select a device.

- 3 Press **OK** (確認) to select.  
↳ TV is switched to the selected device.

## Adjust the TV volume

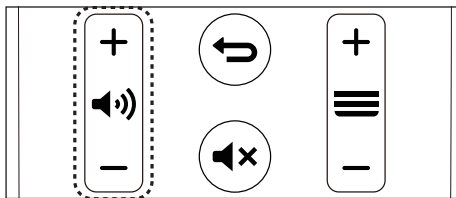

Increase or reduce the volume

- Press **Speaker +/-(音量+/-)** on the remote control.

Mute or Unmute

- Press **Speaker X** Mute button on the remote control.
- Press the **Speaker X** Mute button on the remote control again to restore the sound.

# 5 Using More Feature of your TV

## Accessing the TV menu

The menus can help you set channels, change picture and sound settings, and set other features.

- 1 Press  **OPTIONS** (應用選單)  
↳ Open the menu.

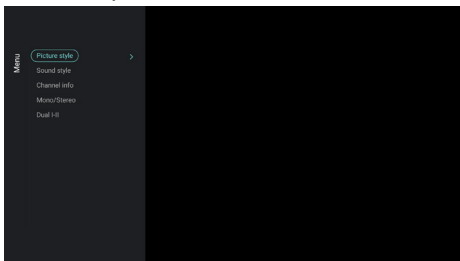

- 2 Select one of the following options, and press **OK** (確認):
  - **[Picture style]:** Applies a predefined picture setting options.
  - **[Sound style]:** Applies a predefined sound setting options
  - **[Channel Info]:** Displays the channel information.
  - **[Mono/Stereo]:** Sets mono or stereo.
  - **[Dual I-II ]:** Chooses a right channel.

### Note

- For different sources, the application menu is different.

## Change languages

You can select the language of the menus.



- 1 Press , select **[Language] > [Menu languages]**, then press **▶**.
- 2 Select the language you want, and then press **OK** (確認).

## Rename the external devices

After an external device is connected through the signal source menu, you can rename it according to your own preferences.



### Note

- The device can be named using up to 10 Chinese and 10 English characters.

- 1 Press  **SOURCES** (訊號源).
- 2 Select the  icon next to the device to be renamed.
- 3 Select the relevant icon.
- 4 Enter the new name.
- 5 After you have entered the new name, select **[Apply]**, and then press **OK** (確認).

## Reset signal source name

Reset signal source name.

- 1 Press  **SOURCES** (訊號源).
- 2 Select the  icon next to the signal source to be reset, and then press **OK** (確認).
- 3 Select **[Reset]**, and then press **OK** (確認).

## Change the picture settings

Change the picture settings to suit your preferences. You can apply the predefined settings or change the settings manually.

### Quick picture settings

This feature can help you quickly set pictures

- 1 Press , select **[Picture] > [Quick Picture and Sound Settings]**, and then press **OK** (確認).

- 2 Select your favorite setting following the on-screen instructions.

## Picture style

Apply a predefined picture setting options by using the picture style.



- 1 Press the  **OPTIONS** (應用選單), and select **[Picture style]**.
- 2 Select one of the following settings, and then press **OK** (確認):
  - **[Vivid]**: Application of dynamic and colorful settings, which is suitable for daytime watching.
  - **[Natural]**: Application of natural picture quality.
  - **[Standard]**: Adjust the picture settings to suit most types of video environments and types.
  - **[Cinema]**: Application of movie-watching settings.
  - **[Photo]**: Suitable for viewing photos.
  - **[Energy saving]**: Application of the low power settings.
  - **[Personal]**: Use of custom picture settings.

## Manually adjust the picture settings

- 1 Press , select **[Picture]**, and then press **OK** (確認).
- 2 Select one of the following settings, and then press **OK** (確認):
  - **[Quick Picture and Sound Settings]**: To select your favorite settings following the on-screen instructions.
  - **[Picture style]**: To select a predefined setting.
  - **[Contrast]**: To adjust the contrast, to increase the intensity difference between highlight and dark.
  - **[Backlight]**: To adjust the backlight intensity.
  - **[Brightness]**: To adjust the intensity and finesse of dark areas.
  - **[Color]**: To adjust the color saturation.
  - **[Sharpness]**: To adjust the sharpness of the image.
  - **[Soft Blue]**: Philips SoftBlue is a revolutionary technology reducing the intensity of the harmful spectrum of the blue light from TV screens. (Note: To adjust picture mode will cause SoftBlue automatically set to "Off".)
  - **[Tint]**: The definition of tint temperature.
  - **[Custom tint]**: To set your favorite picture color balance. (This can only be done when tint temperature is selected and customized.))
  - **[Pixel Plus HD]**: To fine-tune each pixel to match surrounding pixels. This will result in perfect HD images.
    - **[Advanced sharpness]**: To enable the super-high picture sharpness.
    - **[Dynamic contrast]**: To increase the contrast with the change of images.
    - **[Dynamic backlight]**: To dynamically adjust the brightness of the backlight on the TV.
    - **[Color enhancement]**: To make the colors more vivid and richer.
    - **[Gamma]**: To adjust the subtle shades of pictures.
  - **[Advanced]**:
    - **[Noise reduction]**: To filter and reduce the noises in an image.
    - **[PC mode]**: To adjust the picture settings when the computer is connected to the TV set using HDMI.
    - **[Screen edges]**: To adjust the size of the picture to be watched. (When the maximum value is set, you may be able to see noises and uneven edges on the picture.)).
  - **[Picture format]**: To change the picture format.

---

## Changes the picture format

- 1 Press , select **[Picture]** > **[Picture format]**, and then press  .

---

### Picture format summary

You can configure the following picture settings.

#### **Note**

- Depending on the format of picture sources, some picture settings are not available.



**[Super zoom]:**  
(This does not apply to computer mode.) Black edges caused by removal of the 4:3 format. This action will cause slight deformation of the picture.



**[4:3]:**  
Display of the traditional 4:3 picture format.



**[Unscaled]:**  
To adjust the sharpness to the maximum value. Because of the television broadcast system, the picture may have a very little distortion. Set the resolution of your computer to the wide-screen mode for best display results.

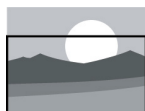

**[Subtitle zoom]:**  
(Not applicable for HD and PC mode.) Remove the black border caused by the 4:3 format and make the subtitles be seen, but the top part of the picture will be partially trimmed.



**[Movie expand 14:9]:**  
(Not applicable for HD and PC mode.) Adjust the picture format from 4:3 to 14:9.

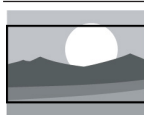

**[Movie expand 16:9]:**  
(This does not apply to computer mode.) Adjust the picture format from 4:3 to 16:9.

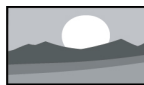

**[Wide screen]:**  
Adjust the picture format from 4:3 to 16:9.



**[Full screen]:**  
(Applies only to HDMI and digital TV signals) This mode corresponds to the reproduction rate set to 100%.

---

## Change the sound settings

Change the sound settings to suit your preferences. You can apply the predefined settings or change the settings manually.

---

### Quick setting of sound settings

This feature helps you quickly set the sound.

- 1 Press , select **[Picture]** > **[Quick Picture and Sound Settings]**, and then press **OK** (確認).
- 2 Select your favorite setting following the on-screen instructions.

---

### Using Sound Style

To apply a predefined sound setting options using sound style.

- 1 Press the  **OPTIONS** (應用選單), select **[Sound Style]**, and then press **OK** (確認).
- 2 Select one of the following settings, and then press **OK** (確認):
  - **[Standard]:** Applies to the sound settings of most environments and types.

- **[News]:**Applies to the sound settings of voice (such as news).
- **[Cinema]:**Applies to the sound settings of movies.
- **[Game]:**Applies to the sound settings of games.
- **[Drama]:**Applies to the sound settings of the drama programs.
- **[Sports]:**Applies to the sound settings of sports programs.
- **[Personal]:**To uses the custom sound settings set in the sound options.

## Manual adjustment of sound settings

- 1 Press , select **[Sound]**, and then press **OK** (確認).
- 2 Select one of the following settings, and then press **OK** (確認).
  - **[Sound style]:**To access the predefined sound settings.
  - **[Bass]:**To adjust bass.
  - **[Treble]:**To adjust treble.
  - **[Balance]:**To adjust the balance of left and right speakers.
  - **[Surround]:**To turn on or off the surrounding function.
  - **[TV position]:**To select your TV mounting mode.
  - **[Advanced]:**
    - **[Auto volume levelling]:**To automatically reduce sudden volume changes in switching channels.
    - **[Clear sound]:**To improve sound clarity.
    - **[SPDIF]:**To select the audio types passing the digital audio output interface (COAXIAL).
      - [PCM]:**To convert the non-PCM audio types to PCM audio format.
      - [RAW]:**To output audio to home theater devices.

## Using application menus

Access the options related to the current activity or selection.

Press the  **OPTIONS** (應用選單) while watching TV.

- ↳ The list of options is divided into picture style, sound style, channel info, mono/stereo, dual I-II.



### Note

- For different sources, the application menu is different.

## Using EPG

Program Guide (EPG) is a on-screen guide provided on the digital channel. Using the EPG, you can

- View the list of digital programs being currently broadcasting.
- Watch the incoming programs.
- Set the show reminder.

## Starting EPG (Program Guide)

- 1 Press  **OPTIONS** (應用選單) .
- 2 Select **[EPG]**, then press **OK** (確認).



### Note

- It cannot be started directly under non-digital channels.

## Reminders (program guide feature)

- Press the “Green” key on the program guide list for reservation or cancel the programs to be reminded for play within a week.

## Use of a timer

You can use a timer in order to switch the TV to standby at a specified time.

---

## Using sleep timer

The sleep timer can switch the TV to standby after a predefined time.

### Tip

- You can turn off the TV in advance, and can reset the sleep timer during the countdown.

- 1 Press , and select **[TV Settings]** > **[Sleep timer]**  
↳ Display of sleep timer.
- 2 Select a preset time between 0-180 minutes.  
↳ The sleep timer can be set with the unit of 10 minutes. If the timer is set to 0, the sleep timer will be shut down.
- 3 Press **OK (確認)** to start the time timer.  
↳ When the preset time is due, the TV set will switch to the standby mode.

---

## Use of TV lock

By locking the TV for control, you can prevent children from watching certain TV shows or channels.

---

## Setting or changing code

- 1 Press , select **[Channels]** > **[Child lock]** > **[Set code]**.
- 2 Enter your password using the number keys on your remote control.  
↳ Set or change your code following the instructions on the screen.

### Tip

- If you have forgotten your code, please enter '8888' to overwrite the existing code.

---

## Locking or unlocking one or more channels

- 1 Press the **OK (確認)** button to open the channel list.

- 2 Select the channel you want to lock or unlock, press  on the remote control, to lock or unlock the channel.  
↳ If it's your first time to watch a locked channel, you will be asked to enter your code.
- 3 The channel locking function will immediately take effect after setting.

### Note

- When you use the channel list or number keys to select a locked channel, it will remind you that you need to enter a code.



---

## Updating the TV software

Philips is continuously striving to improve its products, and we recommend updating your TV software after updates are launched.

---



## Check the current software version

- 1 Press .
- 2 Press the  **OPTIONS (應用選單)**, and select **[About the TV]** > **[Current software info]**, and then press **OK (確認)**.  
↳ Display the current software version information.



---

## Updating software

You can use the following methods to update software:

- Connecting the network for automatic updating.
- 1 Press .
  - 2 Press the  **OPTIONS (應用選單)**, and select **[About the TV]** > **[Auto software updates]**, and then press **OK (確認)**.
  - 3 Update the software following the on-screen instructions.
- Using USB storage devices for automatic updating.



- 1 Press .
- 2 Press the  **OPTIONS** (應用選單), and select **[About the TV] > [Manual software updates]**, and then press **OK** (確認).
- 3 Update the software following the on-screen instructions.

#### Note

- Your USB memory stick should be removed after software update.
- For software update, please use the USB device. The hard disk may cause the update to fail and restart because of the excessive demand for the current.

## Changing TV preferences

- 1 Press , and select **[TV Settings]**.
- 2 Select one of the following items, and then press **OK** (確認).
  - **[Location]**: To select the position of your TV set.
  - **[Picture and Sound reset]**: To restore all the TV picture and sound settings to their default values.
  - **[EasyLink]**: To set the EasyLink-related features.
  - **[About the TV]**: To display the information about TV.
  - **[Key Beep]**: To turn on the button sound of the remote control. When the user presses the remote control button, the TV will give a sound.
  - **[Sleep timer]**: To let the TV set to go into sleep after the set time.
  - **[Clear Cache]**: To clear the cache data from the built-in SD card partitioning.
  - **[Reinstall TV]**: Restore all of the TV settings to their default values.

## Watching TV demos

You can better understand the functions of TV from the TV demos. Some models do not have this function.

- 1 Press .
- 2 Select **[TV Settings] > [Location] > [Shop]**, and then press **OK** (確認) to watch.

## Settings when reset to the factory settings

You can reset the picture and sound settings to the factory settings. Channel settings will not be reset.

- 1 Press , and select **[TV Settings] > [Picture and Sound reset]**, and then press **OK** (確認).
- 2 Select **[OK]**, to start resetting the settings.

# 6 Media playing

## Video formats supported by USB

File formats	Video formats	Maximum code rate
AVI (.avi)	MPEG-1,	80Mbps
	MPEG-2 MP@HL,	80Mbps
	MPEG-4 SP@ L0-3,ASP @ L0-5,	50Mbps
	H.264 MP,HP@Level 4.1,	100Mbps(VCL) 120Mbps(NAL)
	VC1 (AP),	45Mbps
	H263,	5Mbps
	MJPEG,	
MPEG-2 TS Transport Stream (.ts)	MPEG-2 MP@HL,	80Mbps
	MPEG-4 SP@ L0-3,ASP @ L0-5,	50Mbps
	H.264 MP,HP@Level 4.1,	100Mbps(VCL) 120Mbps(NAL)
	AVS baseline @ level 6.0,	50Mbps
	VC1 (AP),	45Mbps
	H265	100Mbps
MPEG FileFormat (.mpeg)	MPEG-1,	80Mbps
	MPEG-2 MP@HL,	80Mbps
	H.264 MP,HP@Level 4.1,	100Mbps(VCL) 120Mbps(NAL)

MPEG-4 Part 14 (.mp4)	H.264 MP,HP@Level 4.1,	100Mbps(VCL) 120Mbps(NAL)
	MPEG-4 SP@ L0-3,ASP @ L0-5,	50Mbps
	H265	100Mbps
QuickTime (.mov)	H.264 MP, HP@ Level 4.1,	100Mbps (VCL) 120Mbps (NAL)
	MPEG-4 SP@ L0-3 ASP @L0-5, MJPEG,	50Mbps
	H265	100Mbps
	BDAV MPEG-2 transport stream (.m2ts)	H.264 MP,HP@Level 4.1, VC1 (AP), MPEG-2 MP@HL,
Matroska (.mkv)	H.264 MP,HP@Level 4.1,	100Mbps(VCL) 120Mbps(NAL)
	VC1 (AP),	45Mbps
	H265	100Mbps
Flash Video (.flv)	H.264 MP,HP@Level 4.1,	100Mbps(VCL) 120Mbps(NAL)
	H263,	5Mbps
Video OBject (.vob)	MPEG-2 MP@HL,	80Mbps
DAT (.dat)	MPEG-1,	80Mbps
Advanced Stream Format (.asf)	VC1 (AP),	45Mbps
	H.264 MP,HP@Level 4.1,	100Mbps(VCL) 120Mbps(NAL)
	MPEG-4 SP@ L0-3,ASP @ L0-5,	50Mbps

3gp	H.264 MP,HP@Level 4.1,	100Mbps(VCL) 120Mbps(NAL)
	H263,	5Mbps
	MPEG-4 SP@ L0-3,ASP @ L0-5,	50Mbps
tp	MPEG-2 MP@HL,	80Mbps
trp	H.264 MP,HP@Level 4.1,	100Mbps(VCL) 120Mbps(NAL)
	MPEG-2 MP@HL,	80Mbps

File formats	Frame rate	Resolution	Audio formats
AVI (.avi)	30FPS	1920x1080	MPEG-1 Layers I, II, III(MP3) AAC, AC3, PCM, WMA, WMAPro
	30FPS	1920x1080	
	30FPS	1920x1080	
	30FPS	1920x1080	
	30FPS	1280x720	
	30FPS	1920x1080	
MPEG-2 TS Transport Stream (.ts)	30FPS	1920x1080	MP3 AAC AC3 PCM
	30FPS	1920x1080	
	30FPS	1920x1080	
	30FPS	1920x1080	
	30FPS	1920x1080	
MPEG File Format (.mpeg)	30FPS	1920x1080	PCM, AC3, MP3
	30FPS	1920x1080	
	30FPS	1920x1080	
MPEG-4 Part 14 (.mp4)	30FPS	1920x1080	AAC
	30FPS	1920x1080	
	30FPS	1920x1080	
QuickTime (.mov)	30FPS	1920x1080	AAC
	30FPS	1920x1080	
	30FPS	1920x1080	
	30FPS	1920x1080	

BDAV MPEG-2 transport stream (.m2ts)	30FPS	1920x1080	AC3, AAC
	30FPS	1920x1080	
	30FPS	1920x1080	
Matroska (.mkv)	30FPS	1920x1080	AAC, AC3, MP3
	30FPS	1920x1080	
	30FPS	1920x1080	
Flash Video (.flv)	30FPS	1920x1080	AAC, MP3
	30FPS	1280x720	
Video OBject (.vob)	30FPS	1920x1080	AC3 PCM MP3
DAT (.dat)	30FPS	1920x1080	PCM MP3
Advanced Stream Format (.asf)	30FPS	1920x1080	mp3, PCM WMA
	30FPS	1920x1080	
	30FPS	1920x1080	
3gp	30FPS	1920x1080	AMR_NB, AAC
	30FPS	1280x720	
	30FPS	1920x1080	
tp	30FPS	1920x1080	MPEG-1 Layers II, AC3
trp	30FPS	1920x1080	MP3
	30FPS	1920x1080	

## Audio formats supported by USB

Audio files	Audio formats	Sample rate	Code rate
Windows Media Audio (.wma)	WMA WMAPro	8KHz ~ 48KHz	128bps ~ 320Kbps
MPEG Audio Layer III (.mp3)	MPEG	32kHz~ 48kHz	32kbps ~ 320kbps

Advanced Audio Coding (.aac)	AAC	16kHz~48kHz	24kbps ~ 384kbps
N/A(Work with video files only)	AC3	32kHz, 44.1kHz, 48kHz	32kbps ~ 640kbps
	EAC3	32kHz, 44.1kHz, 48kHz	32Kbps ~ 6 Mbps
OGG Vorbis (.ogg)	Vorbis	8kHz~48kHz	max 320Kbps

## Picture formats supported by USB

Format	Maximum resolution	Minimum resolution
png	8K*8K(hard parse)	4*4
jpeg	Baseline 8K*8K, (hard parse), progressive 4K*4K	4*4
bmp	8K*8K	4*4

### Note

- If the content, packaging, or coding does not meet the standards, the video content may not play correctly. The failure to play due to some specific parameters of the sources that go beyond the decoding range is not a fault of the machine.
- The animated GIF pictures are not supported.
- Before connecting the device to the TV set, please back up your files to prevent file damage or data loss. For no support for USB storage devices, Philips assumes no responsibility, and shall not be liable for any damage or loss of data in the device.
- Some high-power USB devices might not be supported. (more than 0.5A).
- When connecting or using a USB device, if there is a power overload warning message, you may not be able to identify the device or the device may have problems.

## Viewing photos and playing music and videos from a connected USB storage device.

- 1 Turn on the TV.
- 2 Connect the USB storage device to the USB slot on the side of TV set.
- 3 Press **SOURCES** (訊號源).
- 4 Select **[USB]**, and then press **OK** (確認).
- 5 If there is more than one USB storage device, select the USB storage device to be read, and press **OK** (確認).  
↳ The browse page opens.

## View photos

- 1 Select **[Folders]** or **[Photo]** in the browse page, then press **OK** (確認).
- 2 Select a photo and press **OK** (確認).  
↳ Enlarge the picture to the full screen size.

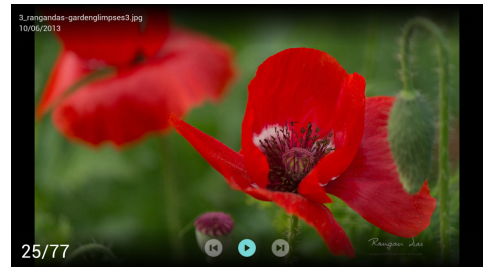

	Start/Pause the slide show
	View the previous/next picture
	Return to the browse page

	Please read the option instructions
--	-------------------------------------

	Previous/Next track
	Return to the browse page
	Please read the option instructions

## Change the slide show settings

- 1 Press **OPTIONS** (應用選單) when playing a slide.  
↳ Display the list of slide show options, and browse photos in accordance with the instructions on the screen.

### Note

- The information about the photos will only appear when the slide stops playing.

## Listen to music

- 1 Select **[Folders]** or **[Music]** in the browse page, and then press **OK** (確認) to play.  
↳ Change the settings for playing music according to the instructions on the screen.

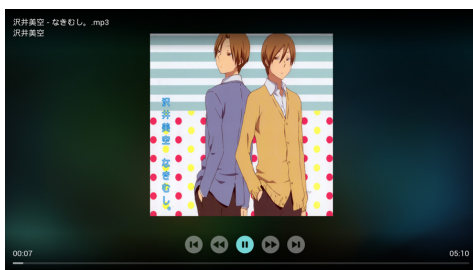

	Start / Pause the music
	Fast rewind/fast forward

## Playing music while viewing slides

You can play background music while viewing slides.

- 1 Select a music album.
- 2 Press **OK** (確認).
- 3 Press to return to the main screen of the browse page.
- 4 Select a picture.
- 5 Press **OK** (確認) to play the slide.

## Watch the movie

- 1 Select **[Folders]** or **[Video]** in the browse page.
- 2 Press **OK** (確認) to play the movie.  
↳ Change the settings for playing the movie according to the instructions on the screen.

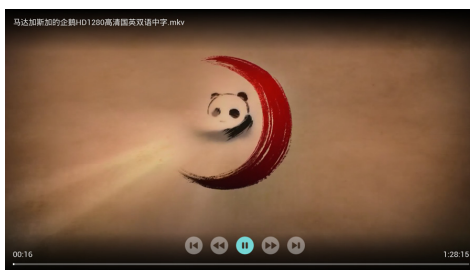

	Start / Pause the video.
	Fast rewind/fast forward

	Previous/Next movie
	Return to the browse page
	Please read the option instructions

## Enable the Family entertainments sharing to view photos and play music and videos

- 1 Turn on the TV.
- 2 Connect the TV to the Internet or the wireless network.
- 3 Start up the multimedia devices that support the Family entertainments sharing.
  - ↳ The multimedia devices for Family entertainments sharing will share multimedia files with the TV through networks.
- 4 Press **SOURCES** (訊號源).
- 5 Select **[Family entertainments sharing]**, and then press **OK** (確認).
  - ↳ The browse page opens.

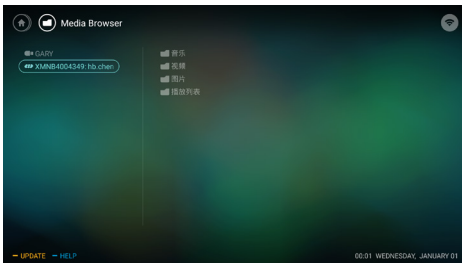

## View photos

- 1 Select **Picture** in the browse page, then press **OK** (確認).
- 2 Select a photo and press **OK** (確認).

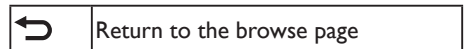
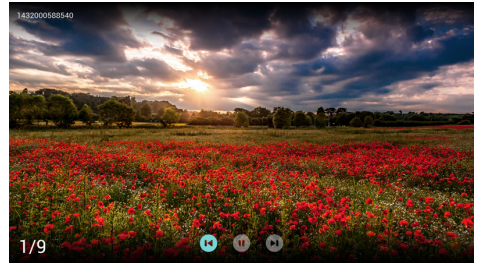

## Listen to music

- 1 Select **Music** in the browse page, and then press **OK** (確認) to play.
  - ↳ Change the settings for playing music according to the instructions on the screen.

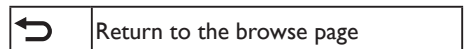
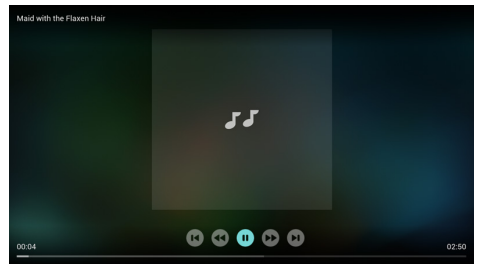

## Watch the movie

- 1 Select **video** in the browse page.
- 2 Press **OK** (確認) to play the movie.

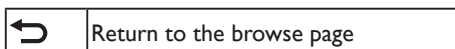
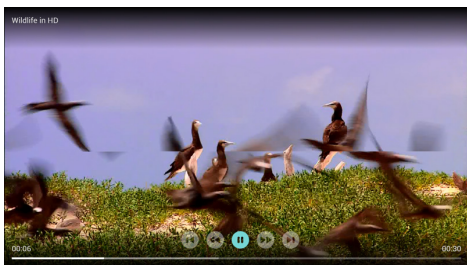

---

## Remove the USB storage device

### Note

- Please follow the following steps to remove the USB storage device to prevent damage.

- 1 Press  to return or leave the main screen of the browse page.
- 2 Wait about five seconds, and then remove the USB storage device.

# 7 Installing channels

The first time you set up your TV, you are prompted to select a menu language and to install TV channels. This section provides instructions on how to re-install and fine-tune channels.

---

## Automatic channel search

- 1 Press .
- 2 Select **[Channels]** > **[Channel settings]** and press **OK** (確認).
- 3 Press **OK** (確認) to start the automatic channel search.

### Note

- This feature can be used only in the TV mode.

---

## Manually setting the channel

### Step 1 Select your system

- 1 Press .
- 2 Select **[Channels]** > **[Analog channel manual installation]**.
- 3 Select your **[Color system]** and **[Sound system]**.

### Note

- If your system settings are correct, you can skip this step.

---

## Step 2 Search and store new channels

- 1 Press .

- 2 Select **[Channels]** > **[Analog channel manual installation]** > **[Find channel]**.
  - Channel frequency can be entered directly.
  - Select **[Search]**, and press **OK** (確認) to start the search.
- 3 Search, and select **[Cancel]** to leave the menu.
- 4 When the search is complete, select **[Save]** and leave the menu.
  - Saving the searched channels

---

## Step 3 Fine-tune the analogue channels

- 1 Press .
- 2 Select **[Channels]** > **[Analog channel manual installation]** > **[Fine tune]**.
- 3 Press **[Decrease]** or **[Increase]** to adjust the channel frequency.

---

## Installing digital channels

- 1 Press .
- 2 Select **[Channels]** > **[Digital channel manual installation]** and press **OK** (確認).
- 3 Enter the channel frequency directly.
- 4 Select **[Search]**, and press **OK** (確認) to start the search.





cable, and turn on the router before you begin network installation.



---

## Wired network settings - automatic search

- 1 Press .
- 2 Select **[Connection]** > **[Wired or Wi-Fi]** > **[Connect to network]** > **[Wired network]**.
- 3 Select **[DHCP]**, then press **OK** (確認).  
↳ Network protocols will be set automatically.

---

## Wired network settings - Manual input

- 1 Press .
- 2 Select **[Connection]** > **[Wired or Wi-Fi]** > **[Connect to network]** > **[Wired network]**.
- 3 Select **[Static IP]**, then press **OK** (確認).
- 4 Press , position the cursor in the input box.
- 5 And press **OK** (確認) again.  
↳ Display of on-screen keypad.
- 6 Use the on-screen keypad to enter the **[IP address]**, **[Subnet mask]**, **[Gateway]** and **[DNS1]**.
- 7 After you have entered, select **[OK]**, then press **OK** (確認).

---

## Wireless installation

- 1 Press .
- 2 Select **[Connection]** > **[Wired or Wi-Fi]** > **[Connect to network]** > **[Wireless network]**.
- 3 Select **[On]**.  
↳ The screen will display the currently set network parameters, and the wireless network that can be connected.

# 9 Connecting Devices

This section describes how to connect devices with different connectors.

## Note

- You can use different types of connectors to connect a device to your TV.

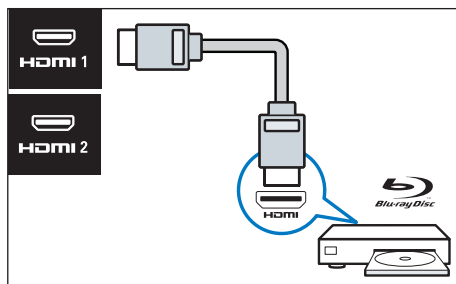

## Note

- Supported resolution: HDMI1 /HDMI2 :FHD

## Bottom Connectors

### ① AV input (left/right video, audio)

- Video: Composite video inputs in the analog devices such as VCR.
- Audio: Audio inputs in the analog devices connected to the video.

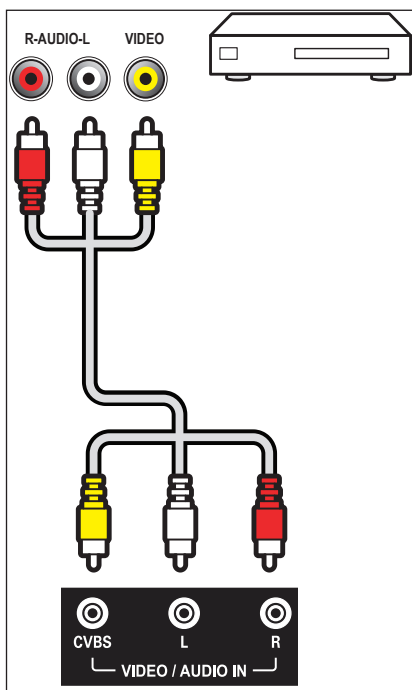

### ② HDMI 1/HDMI 2

Digital audio and video input in Blu-ray disc player and other HD digital devices.

### ③ Connecting computers

Before you connect your computer to your TV.

- Set the refresh rate to 60Hz on the computer's screen.
- Select a supported screen resolution on your computer.

Connecting to your computer through one of the following interfaces:

- HDMI cable

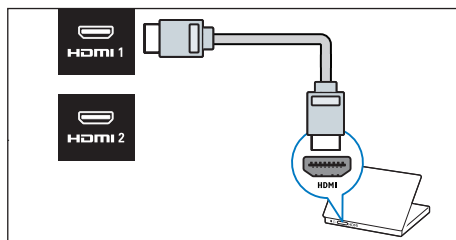

## Note

- HDMI 1 and HDMI 2 supports HDMI 1.4.

### ④ Network port

Network port

- Data input from the network.

## Side Connectors

### ① USB

Data input into USB storage devices.

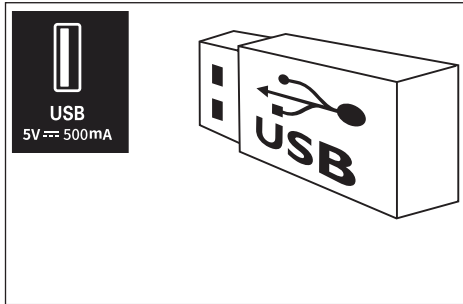

### ② Antenna/cable TV

Input for an antenna, cable or satellite signal.

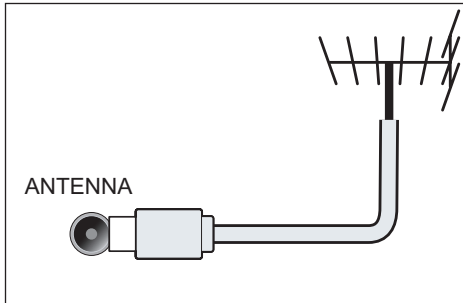

## Using Philips EasyLink

Taking full advantage of your Philips EasyLink HDMI-CEC compatible devices can enhance the control function and achieve the best possible results. HDMI-CEC compatible devices connected through the HDMI connector can be controlled by a TV remote control.

To enable Philips EasyLink, you need to:

- Make sure that each HDMI-CEC compatible device can run normally.
- Switch to EasyLink

### ≡ Note

- EasyLink-compatible device must already be turned on and is selected as a signal source.
- Philips does not guarantee its 100% interoperability with all HDMI CEC devices.

## Turn on or off EasyLink

### ≡ Note

- Please do not enable Philips EasyLink if you do not intend to use it.

- 1 Press .
- 2 Select **[TV Settings]** > **[EasyLink]** > **[EasyLink]**.
- 3 Select **[Off]** or **[On]** and press **OK** (確認).

## Turn on or off the EasyLink remote control

### ≡ Note

- Please do not enable Philips EasyLink if you do not intend to use it.

- 1 Press .
- 2 Select **[TV Settings]** > **[EasyLink]** > **[EasyLink remote control]**.
- 3 Select **[Off]** or **[On]** and press **OK** (確認).

## Using the quick standby

- 1 Press **⏻** (**standby-power on**) on the remote control.
  - ↳ The TV and all connected HDMI devices will be switched to standby.

## Configuring the TV speakers

- 1 Press **⚙️**.
- 2 Select **[TV Settings] > [EasyLink] > [TV Speakers]**.
- 3 Select one of the following items, and then press **OK** (確認).
  - **[Off]**: Turn off the TV speakers.
  - **[On]**: Turn on the TV speakers.
  - **[EasyLink autostart]**: To automatically disable the TV speakers, and transmit the TV audio to the connected HDMI-CEC audio device.

## Media Center

You can browse the pictures, videos or music and other multimedia files in the USB devices or local media.

Choose pictures, video or music files from the home page, and then press the **OK** (確認) button to confirm.

For the operating instructions, refer to [View photos and play music and movies from a connected USB storage device] or [Enable the Family entertainments sharing to view photos and play music and videos]

### Note

- Supported storage devices: Make sure that the USB is connected.

## Multi-screen interaction

You can use a mobile device, such as a Philips W8510, to display the content (the contents to be displayed depends upon the mobile device) on the screen of the mobile device on the TV screen through multi-screen interaction, and support playback of the sound content transmitted by synchronization from the mobile device.

During the transmission, the **🔊 Volume +/-** (音量 +/-) buttons on the remote control can be used to control the volume of sound.

### Note

- Multi-screen interaction feature cannot be compatible with all mobile phone devices.

## Establishing a connection

- 1 Press **⚙️**.
- 2 Select **[Connection] > [Wired or Wi-Fi] > [Screen sharing] > [On]**.
- 3 Use WLAN/Wireless display on a mobile device, to send a connection request > Connection successful, and the pictures on a mobile device are transmitted to the TV screen.

## Way of disconnection

- 1 In transmission, the mobile device is disconnected.
- 2 In transmission, press the **↩️ Return** button on the remote control, etc. can disconnect.

### Note

- Only when the Wi-Fi functions of the TV and the mobile device is turned on can the multi-screen interaction function be used.

# 10 Product Information

Product information may be subject to change without prior notice. For detailed product information, please go to [www.philips.com/TVsupport](http://www.philips.com/TVsupport)

---

## Supported input signal formats

### Computer Formats

- Resolution - refresh rate:
  - 640 × 480 - 60Hz
  - 800 × 600 - 60Hz
  - 1024 × 768 - 60Hz
  - 1360 × 768 - 60Hz

### Video Formats

- Resolution - refresh rate:
  - 480p - 60Hz
  - 576i - 50Hz
  - 576p - 50Hz
  - 720p - 50Hz, 60Hz
  - 1080i - 50Hz, 60Hz
  - 1080p - 50Hz, 60Hz.



### Note

- When the TV set does not support resolution and refresh rate, there will be a black screen or flower screen. Please switch to the TV set to display resolution and refresh rate.

---

## Multimedia

- Supported storage device: USB (Supports FAT 32/FAT 16 USB storage devices.)

---

## Tuner / Reception / Transmission

- Aerial input: 75 ohm coaxial (IEC75)
- TV system: PAL I, DTMB
- Video Play: NTSC, PAL
- Tuner bands: UHF,VHF

---

## Intrinsic Resolution/Sound power

- Intrinsic Resolution
  - 32PHD5773/30: 1366 × 768
- Sound power
  - 32PHD5773/30: 5W × 2

---

## Remote Control

- Battery: 2 × AAA

---

## Power

- Mains: 220V ~ , 50 Hz
- Standby power consumption: ≤ 0.5 W
- Ambient temperature: 5-45 °C
- Power consumption:
  - 32PHD5773/30 : 50W

---

## Dimensions and Weights

### 32PHD5773/30

- Without TV stand
  - (W) × (H) × (D):  
732.57mm × 432.96mm × 77.3mm
  - Weight: 4.11kg
- With TV stand
  - (W) × (H) × (D)  
732.57mm × 495.29mm × 179.31mm
  - Weight: 4.18kg

## Supported TV Mounts

To install the TV set, purchase a Philips TV mounting bracket.

### Warning

- Please follow all the instructions provided with the TV mounting bracket. TP Vision Europe B.V. does not bear any responsibility for any accidents, personal injury or loss caused by improper TV mounting.

- 1 Please first lock the mount behind the TV.
- 2 To prevent damage to cables and connectors, be sure to leave a clearance of at least 2.2 inches or 5.5cm from the back of the locked TV (including the protruding parts of the speakers) to the wall.
- 3 Make sure that your mounting bolts follow these specifications:

TV screen size(inch)	Required dot pitch (mm)	Required mounting screws
32	200 x 100	4 x M4 (We recommend an effective thread length of 12MM (without gaskets), and the maximum thread length of 14MM (without gaskets))

# 11 Trouble Shooting

This section describes the commonly encountered issues and accompanying solutions.

---

## General TV issues

TV set cannot be started:

- Disconnect the power cord plug from the power outlet. Reconnect it one minute later.
- Check that the power cord is firmly connected.

The remote control does not function normally:

- Check that the +/- poles of the remote control battery are installed properly.
- If the remote control batteries are exhausted or leak, please replace it.
- Clean the remote control and TV sensor lens.

The TV standby light is blinking in red:

- Disconnect the power cord plug from the power outlet. Wait until the TV set cools down and then reconnect the cable. If the flashing still occurs, please contact the Philips customer service center.

Forget the code to unlock the TV lock:

- Input '8888'.

The TV menu's display language is wrong:

- Change the TV menu to the desired language.

Hear a squeak in the TV box after turning on/off the TV to standby state:

- You need not perform any action. Squeaking is a normal sound given from normal dilatation of the TV set during cooling and warming. This will not affect performance.

- Check that the selected channel list is correct.

---

## Picture problem

The TV is on, but has no picture:

- Check that the antenna is not properly connected to the TV.
- Check that a correct device is selected as the TV signal source.

There is no sound nor picture:

- Check that the picture settings are correct.

Antenna connection causes bad reception of the TV set:

- Check that the antenna is not properly connected to the TV.
- Loudspeakers, unearthed audio devices, neon lights, high buildings and other large objects can affect the reception quality. If possible, try improving the reception quality by changing the antenna direction or keeping the above device away from the TV set.
- If there is only one channel having poor reception, please fine tune this channel.

Poor picture quality of the device connected thereto:

- Check the connection of the device.
- Check that the picture settings are correct.

The TV set has no settings for saving pictures:

- Check the TV location is set to home settings. This mode gives you the flexibility to change and save settings.

The picture does not fit on the screen, too large or small:

- Try using a different picture format.

The picture position is not correct:

- The picture signal in some devices may not fit the screen correctly. Check the signal output of the device.

---

## TV channels have problems

The previous channel installed does not appear in the channel list:



## Sound problem

There is a picture but the sound quality is poor:

### Note

- If audio signal cannot be detected, the TV set will automatically switch off audio output - This does not indicate a failure.

- Check that all cables are properly connected.
- Check that the volume is not set to 0.
- Check the sound is not muted.

There is picture, but the sound quality is poor:

- Check that the sound settings are set properly.

There is a picture, but only one speaker has sound:

- Check that the sound balance is set to the middle.

## HDMI connection problem

HDMI has a problem:

- Note that HDCP (high-bandwidth digital content protection) support may delay TV display of the time of the contents in the HDMI device.
- If the TV cannot recognize the HDMI device, and does not display, please attempt to switch the signal source from a device to another and switch back again.
- If the sound is on and off, please check the output of the HDMI device is set up correctly.

## Computer connection problem

The computer display is unstable on the TV:

- Check that your PC uses a supported resolution and refresh rate.
- Set the TV picture format to no compression.

## Network connection problems

Web surfing is not working properly:

- If the connection to the router is set up correctly, please verify that the router is properly connected to the Internet.

Browsing speed or Web surfing speed is slow:

- Please refer to your router's user manual to learn about the information such as transmission rates and other factors of signal quality.
- You need to apply to the router's high-speed Internet connection.

## Contact Us

If you cannot resolve the problem, please refer to the frequently asked questions about the TV set in the following Web site:

[www.philips.com/TVsupport](http://www.philips.com/TVsupport).

If the problem is still not resolved, please contact your local Philips customer service center.



### Warning

- Do not attempt to repair the TV on your own. This may cause serious personal injury, and cause irreparable damage to the TV set or void the warranty.



### Note

- Before you contact Philips customer service center, please record your TV models and serial numbers. The numbers are printed on the back and packaging of the TV set.

# 12 Index

---

## Software end user license agreement

THIS SOFTWARE END USER LICENSE AGREEMENT (“THIS AGREEMENT”) IS A LEGAL AND BINDING AGREEMENT BETWEEN YOU (EITHER AN INDIVIDUAL OR ENTITY) AND TPVISION EUROPE B.V., A LIMITED LIABILITY COMPANY LOCATED AT PRINS BERNHARDPLEIN 200, 1097 JB, AMSTERDAM, THE NETHERLANDS, AND ITS AFFILIATED COMPANIES (TOGETHER REFERRED TO AS “TPVISION”). THIS AGREEMENT GIVES YOU THE RIGHT TO USE CERTAIN SOFTWARE (THE “SOFTWARE”) INCLUDING USER DOCUMENTATION IN ELECTRONIC FORM WHICH MAY HAVE BEEN PROVIDED SEPARATELY OR TOGETHER WITH A TPVISION PRODUCT (THE “DEVICE”) OR A PC. BY DOWNLOADING, INSTALLING OR OTHERWISE USING THE SOFTWARE, YOU ACCEPT AND AGREE TO BE BOUND BY ALL OF THE TERMS AND CONDITIONS OF THIS AGREEMENT. IF YOU DO NOT AGREE TO THESE TERMS AND CONDITIONS, DO NOT DOWNLOAD, INSTALL OR OTHERWISE USE THE SOFTWARE. IF YOU ACQUIRED THE SOFTWARE IN TANGIBLE MEDIA E.G. CD WITHOUT THE OPPORTUNITY TO REVIEW THIS LICENSE AND DO NOT ACCEPT THESE TERMS, YOU MAY RECEIVE A FULL REFUND OF THE AMOUNT, IF ANY, THAT YOU PAID FOR THE SOFTWARE IF YOU RETURN THE SOFTWARE UNUSED WITH PROOF OF PAYMENT WITHIN 30 DAYS FROM THE DATE OF PURCHASE.

1. Grant of License. This Agreement grants you a non-exclusive, nontransferable, non-sub licensable license to install and use, on the Device or a PC, as applicable, one (1) copy of the specified version of the Software in object code format as set out in the user documentation

solely for your personal use. The Software is “in use” when it is loaded into the temporary or permanent memory (i.e. RAM, hard disk, etc.) of the PC or the Device.

2. Ownership. The Software is licensed and not sold to you. This Agreement grants you only the right to use the Software, but you do not acquire any rights, express or implied, in the Software other than those specified in this Agreement. TPVISION and its licensors retain all right, title, and interest in and to the Software, including all patents, copyrights, trade secrets, and other intellectual property rights incorporated therein. The Software is protected by copyright laws, international treaty provisions, and other intellectual property laws. Therefore, other than as expressly set forth herein, you may not copy the Software without prior written authorization of TPVISION, except that you may make one (1) copy of the Software for your back-up purposes only. You may not copy any printed materials accompanying the Software, nor print more than one (1) copy of any user documentation provided in electronic form, except that you may make one (1) copy of such printed materials for your back-up purposes only.

3. License Restrictions. Except as provided otherwise herein, you shall not rent, lease, sublicense, sell, assign, loan, or otherwise transfer the Software. You shall not, and you shall not permit any third party, to reverse engineer, decompile, or disassemble the Software, except to the extent that applicable law expressly prohibits the foregoing restriction. You may not remove or destroy any product identification, copyright notices, or other proprietary markings or restrictions from the Software. All titles, trademarks, and copyright and restricted rights notices shall be reproduced on your back up copy of the Software. You may not modify or adapt the Software, merge the Software into another program or create derivative works based upon the Software.

4. Termination of certain functionality. The Software may contain components of certain licensed software including software licensed from Microsoft Corporation (“Microsoft”) which implements Microsoft’s digital rights management technology for Windows Media.

Content providers are using the digital rights management technology for Windows Media (“WM-DRM”) to protect the integrity of their content (“Secure Content”) so that their intellectual property, including copyright, in such content is not misappropriated. Your Device may also use WM-DRM software to transfer or play Secure Content (“WM-DRM Software”). If the security of such WM-DRM Software is compromised, Microsoft may revoke (either on its own or upon the request of the owners of Secure Content (“Secure Content Owners”)) the WM-DRM Software’s right to acquire new licenses to copy, store, transfer, display and/or play Secure Content. Revocation does not alter the WM-DRM Software’s ability to play unprotected content. A list of revoked WM-DRM Software is sent to your PC and/or your Device whenever you download a license for Secure Content. Microsoft may, in conjunction with such license, also download revocation lists onto your Device on behalf of Secure Content Owners, which may disable your Device’s ability to copy, store, display, transfer, and/or play Secure Content. Secure Content Owners may also require you to upgrade some of the WM-DRM components distributed with this Software (“WM-DRM Upgrades”) before accessing their content. When you attempt to play Secure Content, WM-DRM Software built by Microsoft will notify you that a WM-DRM Upgrade is required and then ask for your consent before the WM-DRM Upgrade is downloaded. WM-DRM Software built by TPVISION may do the same. If you decline the upgrade, you will not be able to access Secure Content that requires the WM-DRM Upgrade; however, you will still be able to access unprotected content and Secure Content that does not require the upgrade. WM-DRM features that access the Internet, such as acquiring new licenses and/or performing a required WM-DRM Upgrade, can be switched off. When these features are switched off, you will still be able to play Secure Content if you have a valid license for such content already stored on your Device. However, you will not be able to use certain of the WM-DRM Software features that require Internet access such as the ability to download content that requires the WM-DRM Upgrade. All title and intellectual property rights in and to the Secure Content is the property of the respective Secure Content

owners and may be protected by applicable copyright or other intellectual property laws and treaties. This Agreement grants you no rights to use such Secure Content. To summarize, if the Software contains Microsoft WM-DRM components – Secure Content you desire to download, copy, store, display, transfer, and/or play is protected by the Microsoft WM-DRM components of the Software. Microsoft, Secure Content Owners, or Secure Content distributors may deny you access, or restrict your access, to Secure Content even after you have paid for, and/or obtained, it. Neither your consent nor the consent or approval of TPVISION is necessary for any of them to deny, withhold or otherwise restrict your access to Secure Content. TPVISION does not guaranty that you will be able to download, copy, store, display, transfer, and/or play Secure Content.

5. Open Source Software. (a) This software may contain components that are subject to open-source terms, as stated in the documentation accompanying the Device. This Agreement does not apply to this software as such. (b) Your license rights under this Agreement do not include any right or license to use, distribute or create derivative works of the Software in any manner that would subject the Software to Open Source Terms. “Open Source Terms” means the terms of any license that directly or indirectly (1) create, or purport to create, obligations for TPVISION with respect to the Software and/or derivative works thereof; or (2) grant, or purport to grant, to any third party any rights or immunities under intellectual property or proprietary rights in the Software or derivative works thereof.

6. Termination. This Agreement shall be effective upon installation or first use of the Software and shall terminate (i) at the discretion of TPVISION, due to your failure to comply with any term of this Agreement; or (ii) upon destruction of all copies of the Software and related materials provided to you by TPVISION hereunder. TPVISION’s rights and your obligations shall survive the termination of this Agreement.

7. Upgrades. TPVISION may, at its sole option, make upgrades to the Software available by general posting on a website or by any other

means or methods. Such upgrades may be made available pursuant to the terms of this Agreement or the release of such upgrades to you may be subject to your acceptance of another agreement.

8. Support Services. TPVISION is not obligated to provide technical or other support ("Support Services") for the Software. If TPVISION does provide you with Support Services, these will be governed by separate terms to be agreed between you and TPVISION.

9. Limited Software Warranty. TPVISION provides the Software 'as is' and without any warranty except that the Software will perform substantially in accordance with the documentation accompanying the Software for a period of one year after your first download, installation or use of the Software, whichever occurs first. TPVISION's entire liability and your exclusive remedy for breach of this warranty shall be, at TPVISION' option, either (i) return of the price paid by you for the Software (if any); or (b) repair or replacement of the Software that does not meet the warranty set forth herein and that is returned to TPVISION with a copy of your receipt. This limited warranty shall be void if failure of the Software has resulted from any accident, abuse, misuse or wrongful application. Any replacement Software will be warranted for the remainder of the original warranty period or thirty (30) days, whichever is longer. This limited warranty shall not apply to you if the Software was provided to you free of charge on an evaluation only basis.

10. NO OTHER WARRANTIES. EXCEPT AS SET FORTH ABOVE, TPVISION AND ITS LICENSORS DO NOT WARRANT THAT THE SOFTWARE WILL OPERATE ERROR FREE OR UNINTERRUPTED, OR WILL MEET YOUR REQUIREMENTS. YOU ASSUME ALL RESPONSIBILITIES FOR SELECTION OF THE SOFTWARE TO ACHIEVE YOUR INTENDED RESULTS, AND FOR THE INSTALLATION OF, USE OF, AND RESULTS OBTAINED FROM THE SOFTWARE. TO THE MAXIMUM EXTENT PERMITTED BY APPLICABLE LAW, TPVISION AND ITS LICENSORS DISCLAIM ALL WARRANTIES

AND CONDITIONS, WHETHER EXPRESS OR IMPLIED, INCLUDING BUT NOT LIMITED TO THE IMPLIED WARRANTIES OF MERCHANTABILITY, FITNESS FOR A PARTICULAR PURPOSE, AND ACCURACY OR COMPLETENESS OF RESULTS WITH RESPECT TO THE SOFTWARE AND THE ACCOMPANYING MATERIALS. THERE IS NO WARRANTY AGAINST INFRINGEMENT. TPVISION DOES NOT WARRANT THAT YOU WILL BE ABLE TO DOWNLOAD, COPY, STORE, DISPLAY, TRANSFER, AND/OR PLAY SECURE CONTENT.

11. LIMITATION OF LIABILITY. UNDER NO CIRCUMSTANCES WILL TPVISION OR ITS LICENSORS BE LIABLE FOR ANY CONSEQUENTIAL, SPECIAL, INDIRECT, INCIDENTAL OR PUNITIVE DAMAGES WHATSOEVER, INCLUDING, WITHOUT LIMITATION, DAMAGES FOR LOSS OF PROFITS OR REVENUES, BUSINESS INTERRUPTION, LOSS OF BUSINESS INFORMATION, LOSS OF DATA, LOSS OF USE OR OTHER PECUNIARY LOSS, EVEN IF TPVISION OR ITS LICENSORS HAVE BEEN ADVISED OF THE POSSIBILITY OF SUCH DAMAGES. IN NO EVENT SHALL TPVISION' OR ITS LICENSORS' AGGREGATE LIABILITY FOR DAMAGES ARISING OUT OF THIS AGREEMENT EXCEED THE GREATER OF THE PRICE ACTUALLY PAID BY YOU FOR THE SOFTWARE OR FIVE POUNDS STERLING (5.00).

12. Trademarks. Certain of the product and TPVISION names used in this Agreement, the Software, and the printed user documentation may constitute trademarks of the TPVISION, its licensors or other third parties. You are not authorized to use any such trademarks.

13. Export Administration. You agree that you will not directly or indirectly, export or re-export the Software to any country for which the United States Export Administration Act, or any similar United States law or regulation requires an export license or other U.S. Government approval, unless the appropriate export license or approval has first been obtained. By downloading or installing the

Software you agree to abide by this Export provision.

14. **Governing law.** This Agreement is governed by the laws of your country of residence , without reference to its conflict of laws principles. Any dispute between you and TP VISION regarding this Agreement shall be subject to the non-exclusive jurisdiction of the courts of your country of residence.

15. **General.** This Agreement contains the entire agreement between you and TPVISION and supersedes any prior representation, undertaking or other communication or advertising with respect to the Software and user documentation. If any part of this Agreement is held invalid, the remainder of this Agreement will continue in full force and effect. This Agreement shall not prejudice the statutory rights of any party dealing as a consumer.

May 2016

---

## Disclaimer

- 1 All application programs (APP) provided by Philips Smart Television on the APP Store are legally licensed and are duly protected for the copyrights.
- 2 Where a user installs an APP by means of USB/Network, the copyright does not belong to Philips. Under no circumstances shall Philips assume legal responsibility because a user infringes upon the rights or uses the programs illegally.
- 3 Under no circumstances shall Philips assume any responsibility for the conditions enumerated below as a result of installation by a user at his or her discretion, either directly or indirectly:
  - The matching problem incurred by and between Philips Smart Television and the APP.

- Where the Philips Smart Television breaks down and becomes damaged or unusable.
- A transaction via a third party payment and the product problem so deriving therefrom.

Where you install an application program not provided by Philips Smart Television APP Store, you are deemed to have been fully aware of the aforementioned clauses and disclaimer in full.

---

## Open source

---

### Open-source software

This TV set contains open source software. TPVision Europe B.V. hereby promises that, according to the user's requirements and in accordance with the relevant license, we will provide a copy of the corresponding source code of the copyrighted open source package used in this product.

This promise is valid within three years from anyone's purchase of this product and receiving this information.

To obtain a source code, please send a letter in Chinese to .....

open.source@tpvision.com  
 TPVision Europe B.V.  
 Prins Bernhardplein 200  
 1097 JB Amsterdam

---

### Open source license

README TPVision Netherlands B.V. TV software is part of the source code under the open source license.

This is the source code for use on TV set of TPVision Netherlands B.V., which is carried out under the distributed documents, either the GNU General Public License (GPL) or the Lesser General Public License (THA LGPL), or

any other open source licenses. It indicates that to obtain the copy of the software can be found in the instructions for use.

TPVision Netherlands B.V. does not make any guarantees, nor any express or implied warranties, including any warranty of merchantability or fitness for a particular purpose. For the software, TPVision Netherlands B.V. provides the software support. The above does not affect your warranty. For the statutory right to purchase any TPVision Netherlands B.V. product (s). It applies only to the provision of the source code.

BusyBox (1.24.1)

Source: <http://busybox.net/Das-U-Boot> - Universal Bootloader (2010.06)

Source: <http://www.denx.de/wiki/U-Boot> / WebHomeLinux Kernel (3.18)

Source: <https://kernel.org/Android-platform-frameworks-av> (5.1.1\_r1)

Source: <http://source.android.com/index.html/libjpeg> (6b)

Source: <http://ijg.org/libpng> - PNG Reference Library (1.6.10)

Source: <http://www.libpng.org/pub/png/libpng.html> Android - platform - external - libpng (4.4.2\_r1)

Source: <http://source.android.com/index.html/zlib> (1.2.8) Source: <http://www.zlib.net/> NFS - nfs-utils (1.3.2)

Source: <http://linux-nfs.org/rp-pppoe> (3.11)

Source: [www.roaringpenguin.com/products/pppoe](http://www.roaringpenguin.com/products/pppoe) Android (5.1.1\_r1)

Source: <https://android.googlesource.com/ArpScan> (1.9)

Source: <http://www.nta-monitor.com/tools-resources/security-tools/arp-scan> ISC DHCP (4.3.3)

Source: <http://www.isc.org/downloads/dhcp/FFmpeg> (2.8)

Source: <http://www.ffmpeg.org/ARM-GPU-drive> (r6p0-01rel0) Mali-400/450 GPU Linux Kernel Device Drivers (r6p0-01rel0)

Source: [malideveloper.arm.com](http://malideveloper.arm.com) Khronos Group - OpenMAX (1.1.2)

Source: <http://www.khronos.org/openmax/> iniParser - stand-alone ini Parser library in ANSI C (4.0)

Source: <http://ndevilla.free.fr/iniparser/> Android - platform - system - extras (4.4.2\_r1)

Source: <http://source.android.com/index.html/YAFFS> - Yet Another Flash File System (master-583dbd9)

Source: <http://www.yaffs.net/mtd-utils> (1.5.0)

Source: <http://git.infradead.org/mtd-utils.git> ntfs driver (v1r1\_ntfs\_svn\_21204) Linaro GCC (4.9-2015.06)

Source: <https://www.linaro.org/Android-platform-external-aac> (4.4.2\_r1)

Source: <http://source.android.com/index.html/RealAudio8> Low Bitrate music (1.2.2.1) alsa-lib (1.0.28)

Source: [http://www.alsa-project.org/main/index.php/Main\\_Page](http://www.alsa-project.org/main/index.php/Main_Page) alsa-utils (1.0.28)

Source: [http://www.alsa-project.org/main/index.php/Main\\_Page](http://www.alsa-project.org/main/index.php/Main_Page) PolarSSL (1.3.7)

Source: <https://polarssl.org/my-project-oks> (r3546)

Source: <http://code.google.com/p/my-project-oks/Curl> and Libcurl (7.42.1)

Source: <http://curl.haxx.se/>

# China Rohs law

## Requirement of Usage Control on Electrical and Electronic Product Hazardous Substances

### Names and Levels of Hazardous Substances Contained in this Product

Part Name	Hazardous Substances					
	Lead (Pb)	Mercury (Hg)	Cadmium (Cd)	Hexavalent chromium (Cr(VI))	Polybrominated biphenyls (PBB)	Polybrominated diphenyl ethers (PBDE)
Plastic frame	○	○	○	○	○	○
Rear chassis	○	○	○	○	○	○
LCD panel	CCFL	×	×	○	○	○
	LED	×	○	○	○	○
The circuit board assemblies*	×	○	○	○	○	○
Base	○	○	○	○	○	○
Power cable	×	○	○	○	○	○
Other materials	×	○	○	○	○	○
Remote Control	×	○	○	○	○	○

\*: The circuit board assemblies, including the printed circuit board and its component parts, such as resistors, capacitors, integrated circuits and connectors.

This table is compiled in accordance with SJ/T 11364 requirements.

○: indicates that the hazardous substance contained in all of the homogeneous materials for this part is below the limit requirement in GB/T 26572.

×: indicates that the hazardous substance contained in at least one of the homogeneous materials used for this part is above the limit requirement in GB/T 26572.

Note: In the parts marked "X" above, some of the hazardous substances have exceeded the limit requirements set out in GB/T 26572 in order to meet functional requirements, but are in compliance with the European Union's RoHS requirements (under the exemption section).



This electrical and electronic product contains some hazardous substances. You may be safe to use it during the environment-friendly use period, and please hand it over to recycle system after environment-friendly use period exceeded.

### Suggestive description of the Recycling Administrative Regulations for Waste Electrical and Electronics Products

In order to care and protect the Earth in a better way, when the user no longer needs to use this product, or it has reached the end of the use period, please adhere to the national and applicable laws in relation to the recycling management of waste electrical and electronics products.



© 2019 Koninklijke Philips N.V.

All rights reserved.

Document order number:

Philips and the Philips' Shield Emblem are registered trademarks of Koninklijke Philips N.V.

and are used under licence from Koninklijke Philips N.V.