

在 www.philips.com/welcome

上注册产品并获得支持



42PFL7603

52PFL7403

42PFL7403

47PFL7403

52PFL5403

47PFL5403

42PFL5403

42PFL5203

EN USER MANUAL

PHILIPS

LCD TV

Environmental Information

产品中有毒有害物质或元素的名称及含量

Names and Contents of Toxic or Hazardous Substances or Elements

部件名称 Name of the Parts	有毒有害物质或元素 Hazardous/Toxic Substance					
	铅 (Pb, Lead)	汞 (Hg,Mercury)	镉 (Cd,Cadmium)	六价铬 (Chromium 6+)	多溴联苯 (PBB)	多溴二苯醚 (PBDE)
Housing 外壳	O	O	O	O	O	O
LCD Panel 液晶面板	X	X	O	O	O	O
PWBs 电路板组件	X	O	O	O	O	O
Accessories (Remote control & cables) 附件（遥控器，电 源线，连接线）	X	O	O	O	O	O
Batteries in Remote Control 遥控器电池	X	O	O	O	O	O

O: 表示该有毒有害物质在该部件所有均质材料中的含量均在SJ/T11363 - 2006 标准规定的限量要求以下。

O: Indicates that this toxic or hazardous substance contained in all of the homogeneous materials for this part is below the limit requirement in SJ/T11363 – 2006.

X: 表示该有毒有害物质至少在该部件的某一均质材料中的含量超出SJ/T11363 – 2006 标准规定的限量要求。

X: Indicates that this toxic or hazardous substance contained in at least one of the homogeneous materials used for this part is above the limit requirement in SJ/T11363 - 2006.



环保使用期限 Environmental Protection Use Period

此标识指期限（十年），电子信息产品中含有的有毒有害物质或元素在正常使用的条件下不会发生外泄或突变，用户使用该电子信息产品不会对环境造成严重污染或对其人身、财产造成严重 损害的期限。

This logo refers to the period (10 years) during which the toxic or hazardous substances or elements contained in electronic information products will not leak or mutate so that the use of these [substances or elements] will not result in any severe environmental pollution, any bodily injury or damage to any assets.

电池标识 Battery labeling logo



环保使用期限 Environmental Protection Use Period

此标识指期限（五年），电池中含有的有毒有害物质或元素在正常使用的条件下不会发生外泄或突变，用户使用该电池产品不会对环境造成严重污染或对其人身、财产造成严重 损害的期限。

This logo refers to the period (5 years) during which the toxic or hazardous substances or elements contained in the **battery** will not leak or mutate so that the use of these [substances or elements] will not result in any severe environmental pollution, any bodily injury or damage to any assets.

Table of contents

1 Important	3
1.1 Safety	3
1.2 Screen care.....	4
1.3 Environmental care.....	4

2 Your TV	5
2.1 TV overview.....	5

3 Get started	7
3.1 Position the TV.....	7
3.2 Wall mount the TV.....	7
3.3 Connect the antenna cable	9
3.4 Connect the mains cord	9
3.5 Manage cables.....	10
3.6 Insert the remote control batteries ..	10
3.7 Switch on the TV	10
3.8 Select your location	10
3.9 Re-select your location	10

4 Use your TV	11
4.1 Switch your TV on/off or to standby ..	11
4.2 Watch TV	11
4.3 Watch connected devices	12
4.4 Use Ambilight	12

5 Use more of your TV	13
5.1 Remote control overview	13
5.2 Use TV menus	15
5.3 Adjust picture and sound settings....	16
5.4 Adjust Ambilight settings	19
5.5 Create a surf list	19
5.6 Use timers and child lock	20
5.7 Use Demo mode	22

6 Install channels	23
6.1 Automatically install channels	23
6.2 Manually install channels	23
6.3 Manage channels.....	24
6.4 Change to Shop or Home mode.....	25

7 Connect devices	27
7.1 Connection overview.....	27
7.2 Select connection quality.....	28
7.3 Connect devices.....	29
7.4 Setup devices	31

8 Use your TV as PC monitor	32
8.1 Configure PC mode	32

9 Use your TV in High Definition (HD) mode	33
9.1 Configure HD mode	33
9.2 Configure the TV in HD mode	33
9.3 Display in native 1080 mode	34
9.4 Supported formats	34

10 Use Philips EasyLink	35
--------------------------------------	-----------

11 Technical data	36
--------------------------------	-----------

12 Troubleshooting	37
12.1 General TV issues	37
12.2 Picture issues	37
12.3 Sound issues.....	37
12.4 HDMI connection issues	38
12.5 PC connection issues	38
12.6 Contact us	38

2007 © Koninklijke Philips Electronics N.V. All rights reserved. Specifications are subject to change without notice. Trademarks are the property of Koninklijke Philips Electronics N.V. or their respective owners.

Philips reserves the right to change products at any time without being obliged to adjust earlier supplies accordingly.

The material in this manual is believed adequate for the intended use of the system. If the product, or its individual modules or procedures, are used for purposes other than those specified herein, confirmation of their validity and suitability must be obtained. Philips warrants that the material itself does not infringe any United States patents. No further warranty is expressed or implied.

Warranty

No components are user-serviceable. Do not open or remove covers to the inside of the product. Repairs may only be done by Philips Service Centres and official repair shops. Failure to do so shall void any warranty, stated or implied. Any operation expressly prohibited in this manual, any adjustments, or assembly procedures not recommended or authorised in this manual shall void the warranty.

Pixel characteristics

This LCD product has a high number of colour pixels. Although it has effective pixels of 99,999% or more, black dots or bright points of light (red, green or blue) may appear constantly on the screen. This is a structural property of the display (within common industry standards) and is not a malfunction.

Compliance with EMF

Koninklijke Philips Electronics N.V. manufactures and sells many products targeted at consumers, which, like any electronic apparatus, in general have the ability to emit and receive electromagnetic signals.

One of Philips' leading Business Principles is to take all necessary health and safety measures for our products, to comply with all applicable legal requirements and to stay well within the EMF standards applicable at the time of producing the products.

Philips is committed to develop, produce and market products that cause no adverse health effects.

Philips confirms that if its products are handled properly for their intended use, they are safe to use according to scientific evidence available today.

Philips plays an active role in the development of international EMF and safety standards, enabling Philips

to anticipate further developments in standardisation for early integration in its products.

Copyright



VESA, FDMI and the VESA Mounting Compliant logo are trademarks of the Video Electronics Standards Association.



Manufactured under license from BBE Sound, Inc. Licensed by BBE, Inc under one or more of the following US patents: 5510752, 5736897. BBE and BBE symbol are registered trademarks of BBE Sound Inc.

® Kensington and Micro Saver are registered US trademarks of ACCO World Corporation with issued registrations and pending applications in other countries throughout the world. All other registered and unregistered trademarks are the property of their respective owners.

1 Important

Congratulations on your purchase and welcome to Philips!

Read this user manual before you start to use this product.

Pay close attention to this section and follow the safety and screen care instructions. The product warranty does not apply if damage is caused by failing to follow these instructions.

To fully benefit from the support that Philips offers, register your product at www.philips.com/welcome.

The model and serial number of your TV can be found on the back and side of the TV as well as on the packaging.

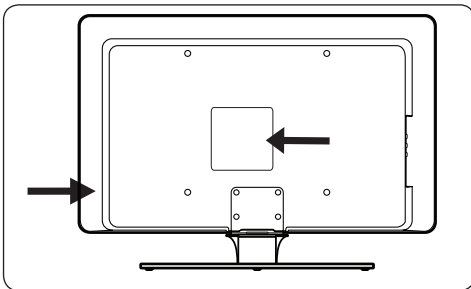

1.1 Safety

- Two people are required to lift and carry a TV that weighs more than 25 kg (55lb). Improper handling of the TV can result in serious injury.
- If transporting the TV in low temperatures (less than 5°C), open the box and wait until the TV matches the ambient temperature of the room before unpacking.
- To avoid short circuit, do not expose the TV, remote control or remote control batteries to rain or water.
- Do not place vessels of water or other liquids on top of or near the TV. Spilling liquids on the TV can cause electric shock.
- If liquids are spilt on the TV, do not operate the TV. Immediately disconnect the TV from the mains and have the TV checked by a qualified technician.
- To avoid risk of fire or electric shock, do not place the TV, remote control or remote control batteries near naked flame sources (e.g. lighted candles) and other heat sources including direct sunlight.
- Do not install the TV in a confined space such as a bookcase. Leave a space of at least 10cm (four inches) around the TV for ventilation. Be sure air flow is not obstructed.
- If placing the TV on a flat, solid surface be sure to use only the supplied stand. Do not move the TV if the stand is not properly screwed to the TV.
- Wall mounting of the TV should only be performed by qualified personnel. The TV must only be mounted on an appropriate wall bracket and on a wall that can safely hold the weight of the TV. Improper wall mounting can result in severe injury or damage. Do not attempt to wall mount the TV yourself.
- If the TV is mounted on a swivel base or swivel arm, ensure no strain is placed on the power cord when the TV is swivelled. Strain on the power cord can loosen connections and cause arcing or fire.
- Disconnect the TV from the mains and antenna before lightning storms. During lightning storms do not touch any part of the TV, mains cord or antenna cable.
- Be sure that you have full access to the mains cord for easy disconnection of the TV from the mains.
- When disconnecting the TV from the mains, be sure to:
 - Turn off the TV, then the mains power (if available).

- Unplug the mains cord from the mains socket outlet.
- Unplug the mains cord from the power connector at the back of the TV. Always pull the mains cord by the plug. Do not pull the mains cord.

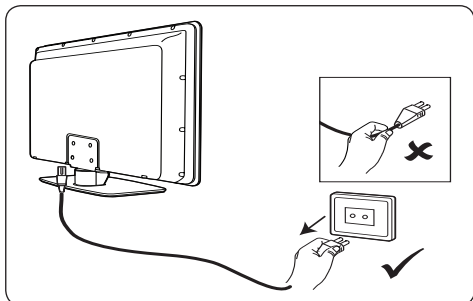

- Permanent hearing loss may occur if you use earphones or headphones at high volumes. Though high volume may sound normal over time, it can damage your hearing. To protect your hearing, limit the amount of time you use earphones or headphones at high volume.

1.2 Screen care

- Turn off and unplug the mains cord before cleaning the screen. Clean the screen with a soft, dry cloth. Do not use substances such as household cleaning agents as these may damage the screen.

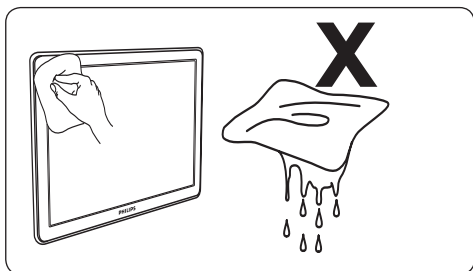

- To avoid deformations or colour fading, wipe off water droplets as soon as possible.
- Do not touch, push, rub or strike the screen with hard objects as this may damage the screen permanently.

- Where possible, avoid stationary images that remain on-screen for extended periods of time. Examples include screen menus, teletext pages, black bars or stock market tickers. If you must use stationary images, reduce the screen contrast and brightness to avoid screen damage.

1.3 Environmental care

Recycling your packaging

The packaging of this product is intended to be recycled. Contact your local authorities for information on how to recycle the packaging.

Disposing your used product

Your product is manufactured with high-quality materials and components that can be recycled and reused. When you see the crossed-out wheel bin symbol attached to a product, it means the product is covered by the European Directive 2002/96/EC:



Do not dispose your used product with household waste. Ask your dealer for information on how to safely dispose of the product. Uncontrolled waste disposal harms both the environment and human health.

Disposing used batteries

The supplied batteries do not contain mercury or cadmium. Dispose supplied and all other used batteries according to your local regulations.

Power consumption

The TV consumes minimal energy in standby mode to minimise environmental impact. Active power consumption is displayed at the back of the TV.

For more product specifications, see the product leaflet at www.philips.com/support.

2 Your TV

This section gives you an overview of commonly-used TV controls and functions.

2.1 TV overview

Side controls and indicators

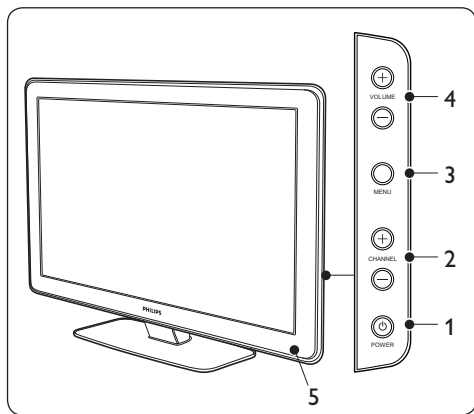

1. **POWER**
2. **CHANNEL +/-**
3. **MENU**
4. **VOLUME +/-**
5. Standby indicator / Remote control sensor

Side connectors

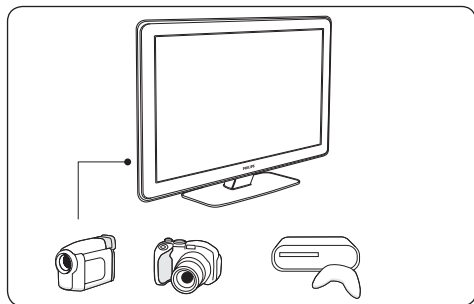

Use the TV side connectors to connect to mobile devices such as a camera or high-definition game console. You can also connect a pair of headphones.

Back connectors

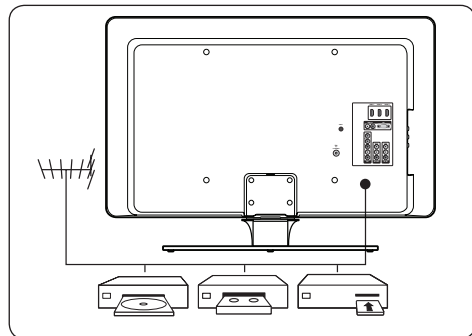

Use the TV back connectors to connect to the antenna and permanent devices such as a high-definition disc player, DVD player or VCR.

Note
For more information about TV connections, see *Section 7 Connect devices.*

Remote control

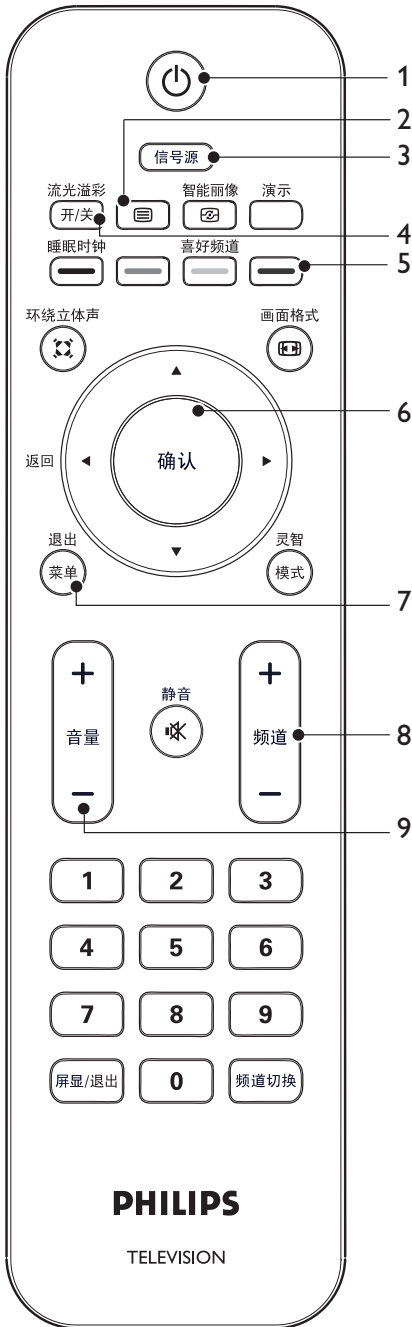

1. Power
2. No function
3. 信号源 (Source)
4. 流光溢彩 (Ambilight)
5. No function
6. Navigation keys
Up ▲, Down ▼, Left ◀, Right ▶, OK
7. 菜单 (Menu)
8. 频道 +/- (Channel +/-)
9. 音量 +/- (Volume +/-)

For more information about the remote control, see *Section 5.1 Remote control overview*.

☰ Note

Remote control may differ according to TV model.

3 Get started

This section helps you position and install the TV and supplements the information provided in the *Quick Start Guide*.

If necessary, refer to the *Quick Start Guide* for stand mounting instructions.

3.1 Position the TV

In addition to reading and understanding the safety instructions in *Section 1.1*, consider the following before positioning your TV:

- The ideal viewing distance for watching TV is three times its screen size.
- Position the TV where light does not fall directly on the screen.
- Connect your devices before you position your TV.
- Your TV is equipped with a Kensington Security Slot at the back of the TV.

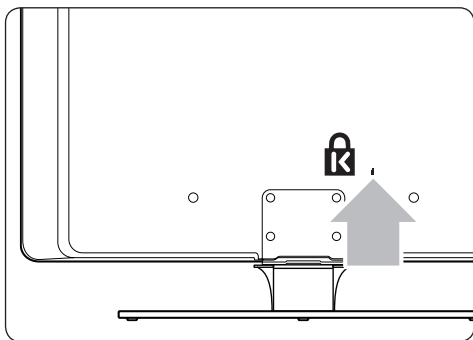

If connecting an anti-theft Kensington lock (not supplied), position the TV within reach of a permanent object (such as a table) that can be easily attached to the lock.

- For the best Ambilight effect, position the TV 10cm (four inches) to 20cm (eight inches) away from the wall. Ambilight also works best in a room with dim lighting.

3.2 Wall mount the TV

⚠ WARNING

Wall mounting of the TV should only be performed by qualified installers. Koninklijke Philips Electronics N.V. bears no responsibility for improper mounting that results in accident or injury.

Step 1 Purchase a VESA-compatible wall bracket

Depending on the size of your TV screen, purchase one of the following wall brackets:

TV screen size (inches/cm)	VESA-compatible wall bracket type (millimeters)	Special instructions
32"/82 cm	Adjustable 300 x 300	The VESA-compatible bracket must be adjusted to 200 x 300 before securing to the TV
42"/107 cm or larger	Fixed 400 x 400	None

Step 2 Remove the TV stand

Note

These instructions are only applicable to TV models with mounted stands. If your TV stand is not mounted, skip to *Step 3 Connect cables*.

1. Carefully place the TV face down on a flat, stable surface that is covered by soft cloth. The cloth should be thick enough to protect your screen.

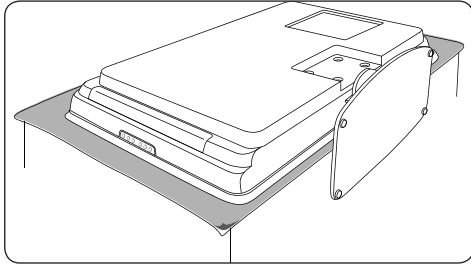

2. Using a cross-head screwdriver (not supplied), unscrew the four screws that secure the stand to the TV.

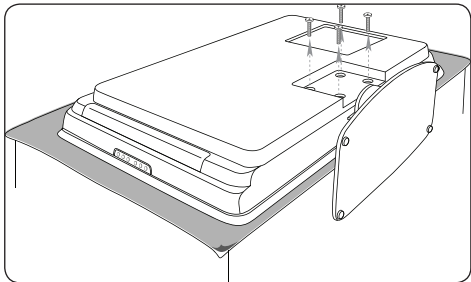

3. Firmly pull the stand from the bottom of the TV. Place both the stand and screws in a secure location for future reinstallation.

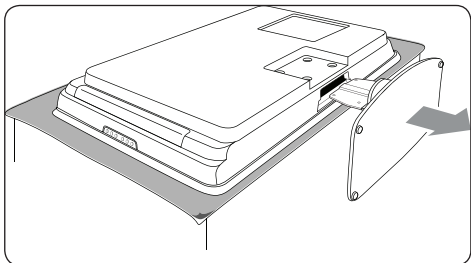

Step 3 Connect cables

Connect the antenna cable, mains cord and all other devices to the back of the TV as described in the following sections and in *Section 7 Connect devices*.

Step 4 Secure the VESA-compatible wall bracket to the TV

WARNING

Use bolts (M6 for 32 inch models, M8 for all other models) and spacers to secure the VESA-compatible wall bracket to your TV.

Note

Depending on your VESA-compatible wall bracket, you may need to separate the mounting plate from the wall bracket for easier installation. Refer to your VESA-compatible wall bracket documentation for instructions.

1. Locate the four mounting nuts at the back of the TV.

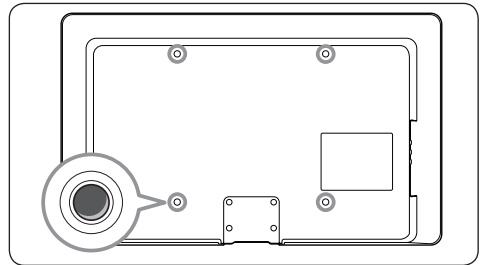

- Align the plate/bracket to the four mounting nuts, placing the supplied spacers between the plate/bracket and the mounting nuts.

Using a spanner or cross-head screwdriver, insert the supplied bolts through the plate/bracket and spacers, tightly securing the bolts to the mounting nuts.

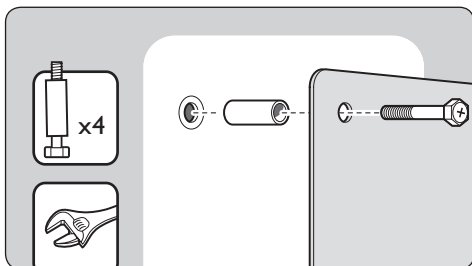

- Continue with the instructions provided with your VESA-compatible wall bracket.

3.3 Connect the antenna cable

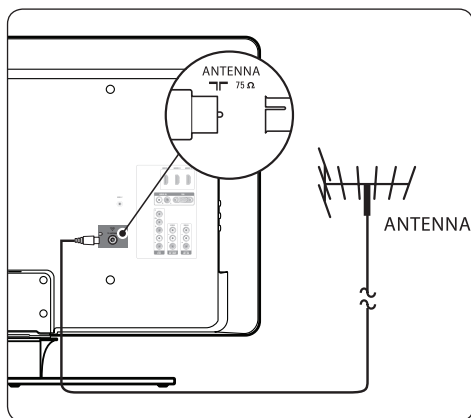

- Locate the **TV ANTENNA** connector at the back of the TV.
- Connect one end of the antenna cable (not supplied) to the **TV ANTENNA** connector. Use an adaptor if the antenna cable does not fit.
- Connect the other end of the antenna cable to your antenna outlet, ensuring that the cable is tightly secured at both ends.

3.4 Connect the mains cord

⚠ WARNING

Verify that your mains voltage corresponds with the voltage printed at the back of the TV. Do not insert the mains cord if the voltage is different.

3.4.1 To connect the mains cord

📌 Note

The location of the mains connector varies according to TV model.

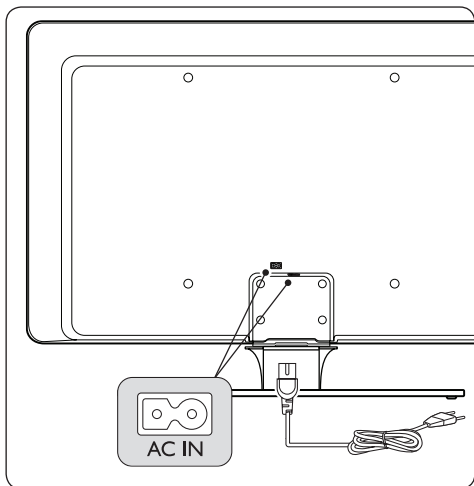

- Locate the **AC IN** mains connector at the back or on the bottom of the TV.
- Connect the mains cord to the **AC IN** mains connector.
- Connect the mains cord to the mains, ensuring that the cord is tightly secured at both ends.

3.5 Manage cables

Route your mains cord, antenna cable and all other device cables through the cable holder at the back of the TV. This holder helps keep your cables tidy and easily manageable.

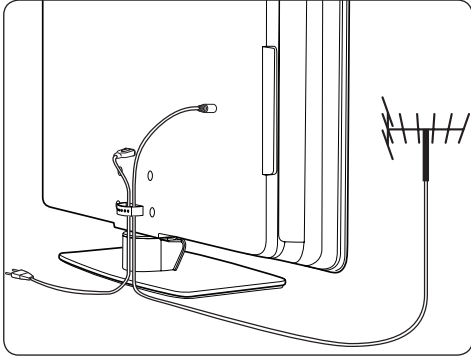

3.6 Insert the remote control batteries

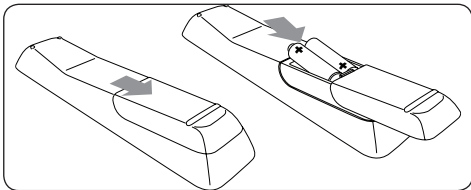

1. Slide the battery cover off the back of the remote control.
2. Insert the two supplied batteries. Be sure the + and - ends of the batteries line up with the markings inside the case.
3. Slide the cover back into position.

⊞ Note

Remove the batteries if not using the remote control for an extended period of time.

3.7 Switch on the TV

The first time you switch on the TV, check that the mains cord is properly connected. When ready, turn on the mains, then press **POWER** on the side of the TV.

3.8 Select your location

The first time and only the first time when you switch on the TV, an on-screen display will prompt you to select a location. The location settings is to maximise your viewing pleasure depending on your environment at home or at the shopfloor.

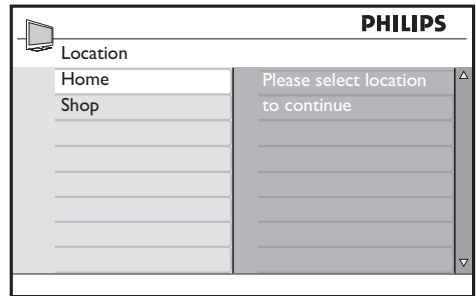

4. Press ▲ or ▼ a location.
5. Press 确认 to confirm your choice.

3.9 Re-select your location

If you wish to re-select your location, see *Section 6.4 Change to Shop or Home mode.*

4 Use your TV

This section helps you perform basic TV operations. Instructions on advanced TV operations are provided in *Section 5 Use more of your TV*.

4.1 Switch your TV on/off or to standby

4.1.1 Switch on your TV

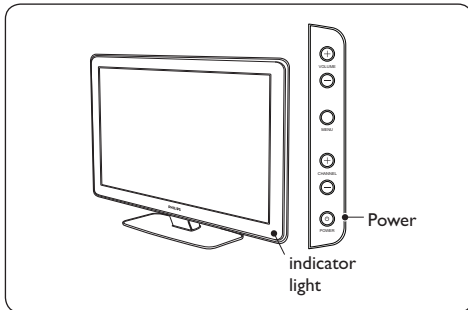

- Press **POWER** on the side of the TV. An indicator light comes on.

4.1.2 Switch off your TV

- Press **POWER** on the side of the TV. The indicator light switch off.

4.1.3 Switch your TV to standby

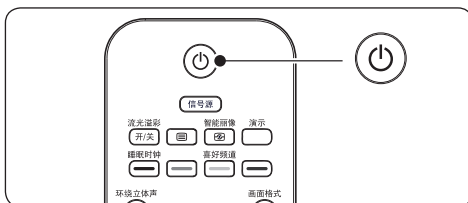

- Press **POWER** on the remote control.

* Tip

Though your TV consumes very little power when in standby, energy continues to be consumed as long as the mains remain connected and powered. When not in use for extended periods of time, switch off and disconnect the TV from the mains.

4.1.4 Switch on the TV from standby

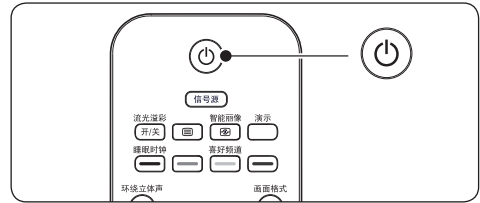

- If the standby indicator is on (red), press **POWER** on the remote control.

Note

If you cannot locate your remote control and you want to switch on the TV from standby, press **CHANNEL + or -** on the side of the TV.

4.2 Watch TV

4.2.1 Switch channels

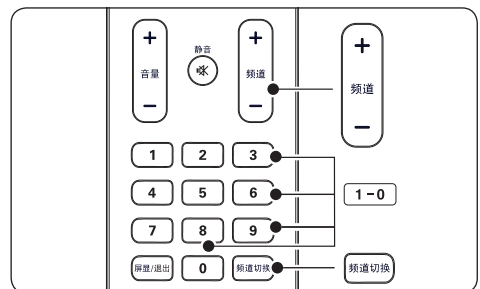

- Press a number (0 to 99) or press **频道 +/-** on your remote control.
- Press **CHANNEL +/-** on the side controls of the TV.
- Press **频道切换** on the remote control to return to the previously viewed TV channel.

4.2.2 Adjust volume

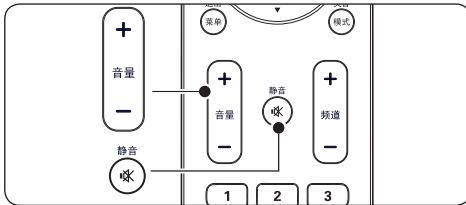

- Press 音量 + or - on the remote control.
- Press 音量 + or - on the side controls of your TV.
- Press 静音 on the remote control to mute the sound. Press 静音 again to unmute on the sound.

4.3 Watch connected devices

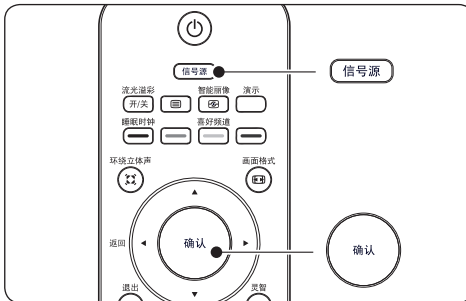

1. Switch on the device.
2. Press 信号源 on the remote control then select the input your device is connected to.
3. Press 确认 to select the device.

4.4 Use Ambilight

☹ **Ambilight** is not available in all models.

Ambilight is an innovative Philips feature that adds reactive ambient lighting to your viewing experience.

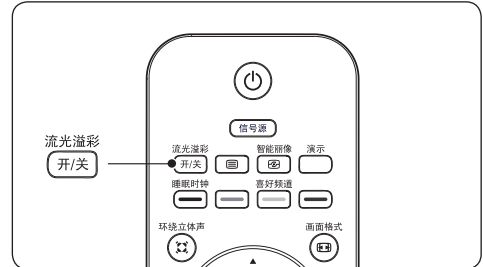

1. Press 流光溢彩 on the remote control. Ambilight turns on.
2. Press 流光溢彩 again to turn off Ambilight.

For more information on Ambilight, see [Section 5.4 Adjust Ambilight settings](#).

✳ **Tip**

A dimly lit room is ideal for a complete Ambilight experience.

5 Use more of your TV

This section helps you perform advanced TV operations, including how to:

- Use the TV menus (Section 5.2)
- Adjust picture and sound settings (Section 5.3)
- Adjust Ambilight settings (Section 5.4)
- Create a surf list (Section 5.5)
- Use timers and child lock (Section 5.6)
- Use Demo mode (Section 5.7)

5.1 Remote control overview

This section provides a detailed overview of remote control features.

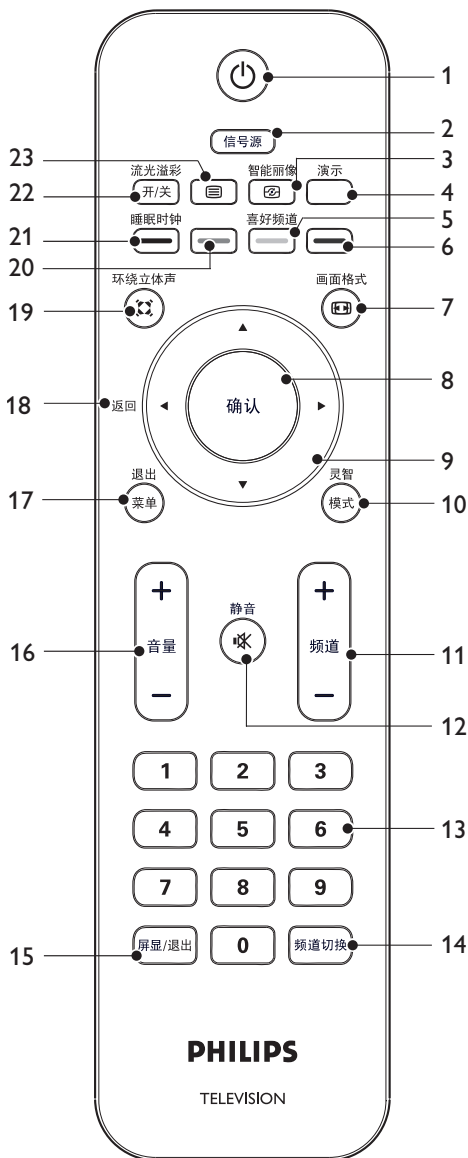

1. **POWER**
Switches the TV on from standby or back to standby.
2. 信号源 (**SOURCE**)
Selects connected devices.
3. 智能丽像 (**ACTIVE CONTROL**)
Select **On**, **Off**, or **On + Light Sensor***.
The TV measures and corrects incoming signals to provide the best picture.
4. 演示 * (**DEMO**)
Toggles the **Demo** menu on or off.
5. 喜好频道 (**SURF**)
Stores favourite channels.
6. No function.
7. 画面格式 (**FORMAT**)
Toggles through a selection of picture formats.
8. 确认 (**OK**)
Accesses the menus and activates settings.
9. **NAVIGATION KEYS**
Navigates the menu.
10. 灵智 模式 (**SMART MODE**)
Toggles through predefined picture and sound settings.
11. 频道 +/- (**CHANNEL +/-**)
Switches to the next or previous channel.
12. 静音 (**MUTE**)
Turns the sound on or off.
13. **NUMBER KEYS**
Selects a channel, page or setting.
14. 频道切换 (**ALTERNATE CHANNEL**)
Returns to the previously-viewed channel.
15. 屏显/退出 (**STATUS/EXIT**)
Displays channel information or exits from a menu.
16. 音量 +/- (**VOLUME +/-**)
Increases or decreases volume.
17. 菜单/退出 (**MENU/EXIT**)
Switches the menu on or off.
18. 返回 (**BACK**)
To return to the previous menu.
19. 环绕立体声 (**INCREDIBLE SURROUND**)
Enables Incredible Surround with stereo sources. Spatial mode is enabled with mono sources.
20. No function.
21. 睡眠时钟 (**SLEEP**)
Activates Timer menu.
22. 流光溢彩 * (**AMBILIGHT***)
Switches Ambilight on or off.
23. No function.

* Available in selected models.

5.2 Use TV menus

On-screen menus help you install your TV, adjust picture, sound and Ambilight settings and access other features. This section describes how to navigate the menus.

5.2.1 Access the main menu

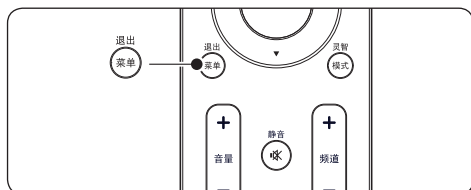

1. Press 菜单 on the remote control to display the main menu.

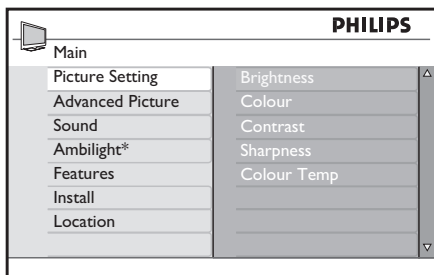

* Available in selected models

2. Press 菜单 to exit.

The main menu offers the following items:

- **Picture Setting**
To adjust picture settings such as Brightness, Colour, Contrast, Sharpness and Colour Temperature. See *Section 5.3 Adjust Picture and Sound settings.*
- **Advanced Picture**
To turn on or off advance picture settings such Contrast+, Active Control, Artifacts Reduction* and HD Natural Motion*. See *Section 5.3 Adjust Picture and Sound settings.*

* Available in selected models.

- **Sound**
To adjust sound settings such as Equalizer, Balance, Auto Volume Leveller, Incredible

Surround, and BBE. See *Section 5.3 Adjust Picture and Sound settings.*

- **Ambilight**
To turn Ambilight on or off and to change the mode. See *Section 5.4 Adjust Ambilight settings.*
- **Features**
To turn features on or off and to adjust special features such as Timer, Child Lock, Parental Lock and Demo See *Section 5.6 Use timers and child lock and Section 5.7 Use Demo mode.*
- **Install**
To select the display language, auto store, manual store, sort and name TV channels, and to store a list of favourite channels. See *Section 6 Install channels.*
- **Location**
To change your TV location to the Home or Shop mode. See *Section 6.4 Change to Shop or Home mode.*

5.2.2 Use the main menu

This section describes how to use the main menu.

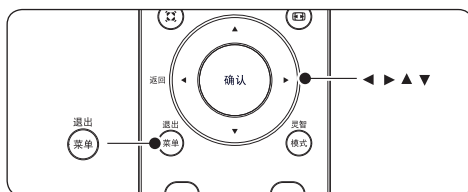

1. Press 菜单 on the remote control to display the main menu.

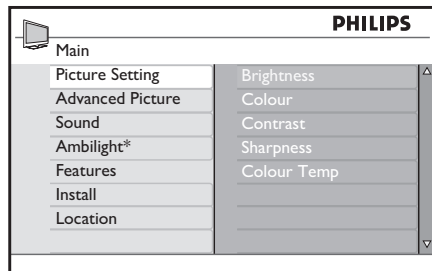

* Available in selected models

- Press ► to enter the **Picture Setting** menu.

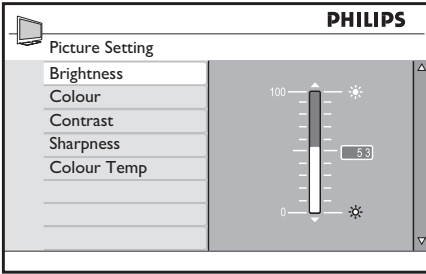

- Press ► to select **Brightness**.
- Press ► to enter the **Brightness** setting.

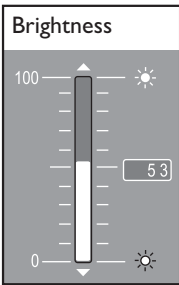

- Press ▲ or ▼ to adjust the setting.
- Press ◀ to return to the **Picture** settings or press 菜单 to exit.

ⓘ Note

More choices are available when HD equipment or PC is connected.

5.3 Adjust picture and sound settings

This section describes how to adjust picture and sound settings.

5.3.1 Adjust picture settings

- Press 菜单 on the remote control and select **Picture Setting** or **Advanced Picture**.

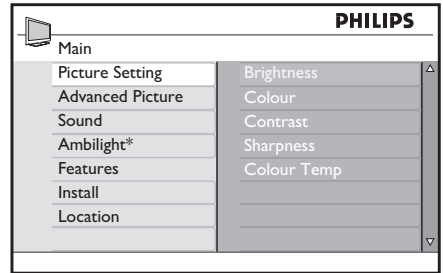

* Available in selected models

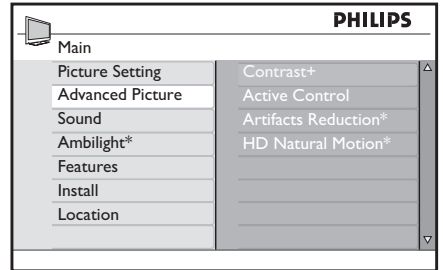

* Available in selected models

- Press ► to enter the list.
- Press ▲ or ▼ to select a setting:
 - **Brightness**
Changes the level of light in the picture.
 - **Colour**
Changes the level of saturation.
 - **Contrast**
Changes the level of bright parts in the picture keeping the dark parts unchanged.
 - **Sharpness**
Changes the level of sharpness of fine details.
 - **Colour Temperature**
Sets the colours to **Normal**, **Warm** (reddish) or **Cool** (bluish).
 - **Contrast+**
Changes the contrast range of the picture. Switch on or off.
 - **Active Control**
Corrects all incoming signals to provide

the best picture possible. Switch on, off, or on+light sensor*.

- **Artifacts Reduction***
Smoothens the transitions on digital pictures. Switch on or off.
- **HD Natural Motion***
Reduces the field and line flicker and reproduces smooth movement especially in movies. Switch on or off.

* Available in selected models.

5.3.2 Use Smart Mode

Apart from manually adjusting picture settings, you can use **Smart Mode** to set your TV to a predefined picture, sound and Ambilight setting.

1. Press 灵智 模式 on the remote control to toggle through a selection of pre-defined picture and sound settings.



Summary of smart modes

- **Vivid**
Sharp picture settings and clear sound for high action.
- **Standard**
For normal TV viewing.
- **Movie**
Brilliant picture settings for a cinematic experience.
- **Game**
Optimised for PCs, game consoles and playstations.
- **Power Saver**
Eco friendly settings to reduce power consumption.

- **Personal**
Based on the settings you customised in the **Picture Setting** menu.

- ⊖ **Note:** The power meter displayed on the screen indicates the power consumption for each mode. For example, 10% means this mode uses 10% of the TV's total power consumption in wattage.

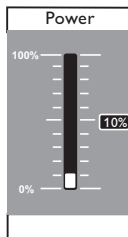

5.3.3 Change picture format

Change the picture format to suit your content.

1. Press 画面格式 on your remote control.



2. Press ◀ or ▶ to select one of the following picture formats:

- **Wide screen**

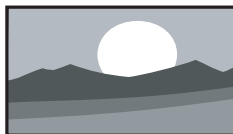

The picture is displayed in the original proportions of images transmitted in 16:9 format.

- ⊖ **Note:** If you display a 4:3 picture in widescreen mode, the picture is stretched horizontally.

- **4:3**



The picture is reproduced in 4:3 format and a black band is displayed on either side of the picture.

- **Movie expand 14:9**

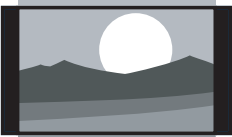

The picture is shown in 14:9 format. A thin black band remains on both sides of the picture and the top and bottom of the picture is clipped off.

- **Movie expand 16:9**

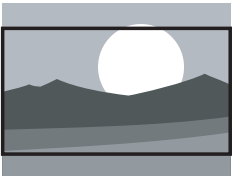

The picture is enlarged to 16:9 format. This mode is recommended when displaying pictures with black bands at the top and bottom (letterbox). In this mode, large parts of the top and the bottom of the picture are clipped off.

- **Subtitle Zoom**

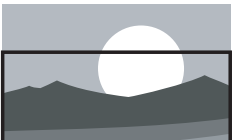

This mode is used to display 4:3 pictures using the full surface of the screen leaving the sub-titles visible. Part of the top of the picture is clipped off.

- **Super zoom**

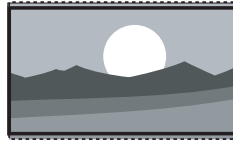

This mode is used to display 4:3 pictures using the full surface of the screen by enlarging the sides of the picture.

5.3.4 Adjust sound settings

This section describes how to adjust sound settings.

1. Press **菜单** on the remote control and select **Sound**.
2. Press **▶** to enter the list.

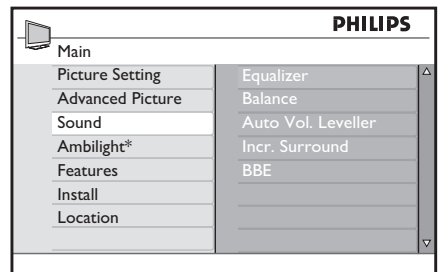

** Available in selected models*

3. Press **▲** or **▼** to select one of the following settings:
 - **Equalizer**
Adjusts each individual frequency (tone).
 - **Balance**
Balances the left and right speaker's sound level.
 - **Auto Volume Leveller**
Controls the sudden sound level increase when changing channels or during commercial break.
 - **Incredible Surround**
Enhances stereo effect. Select **Incr. Surround** or **Stereo** (when in stereo)

mode) or **Mono** or **Spatial** (when in mono mode).

- **BBE** (High definition sound)
An enhancement technology licensed by BBE Sound. Restores clarity and presence for better speech intelligibility and musical realism.

5.4 Adjust Ambilight settings

This feature is not available on all models.

1. Press 菜单 on the remote control and select **Ambilight**.
2. Press ▶ to enter the list.

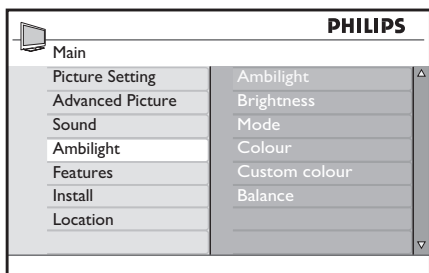

3. Press ▲ or ▼ to select one of the following settings:

- **Ambilight**
Switches Ambilight on or off.
- **Brightness**
Changes the light output of Ambilight.
- **Mode**
Chooses from four Ambilight modes: Colour, Relaxed, Moderate, and Dynamic.
- **Colour**
Selects a pre-defined colour setting (Warm white, Cool white, Blue, Red, Green, Yellow, Magenta, or make a custom colour of your own).

⊖ Note

This option appears only after you select **Mode > Colour** above.

- **Custom Colour**

Sets the colour saturation or palette.

⊖ Note

This option appears only after you select **Colour > Custom** above.

- **Balance**

Sets the level of Ambilight on the left and right side of the TV.

⚠ Caution

To avoid poor remote control reception, do not place remote control sensors on your devices in range of Ambilight.

5.5 Create a surf list

You can store up to eight frequently watched channels in a surf list.

1. Select a channel that you want to add to the surf list.
2. Press 喜好频道 on the remote control to display the surf list.

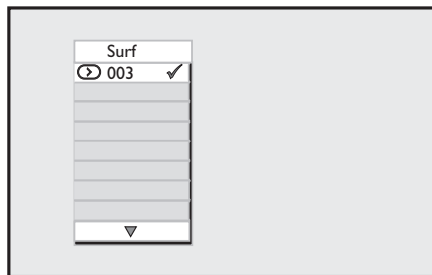

3. Press ▶ to add the selected channel to the surf list.
4. Repeat steps 1 to 3 to add more channels to the list.
5. Press 屏显/退出 to exit.

To view the a channel from the surf list

1. Press 喜好频道 to display the surf list.
2. Press ▲ or ▼ until you find the channel.

To delete a channel from the surf list

1. Press 喜好频道 to display the surf list.
2. Press ▲ or ▼ until you find the channel that you wish to delete.

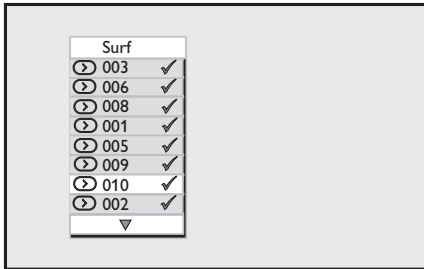

3. Press ► to delete the channel.

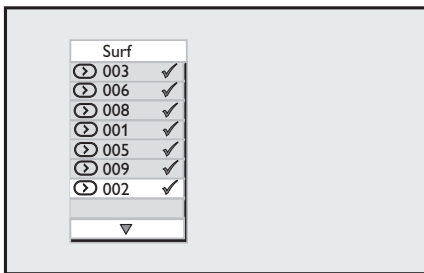

4. Repeat steps 1 to 3 to delete more channels from the list.
5. Press 屏显/退出 to exit.

5.6 Use timers and child lock

This section describes how to switch the TV on or off at a specified time and to lock or unlock the TV. Child lock is useful in preventing your children from watching non-authorised content.

5.6.1 Automatically switch the TV to standby (Sleep timer)

Sleep timer switches the TV to standby after a defined period of time.

1. Press 菜单 on the remote control and select **Features > Timer > Sleep**.

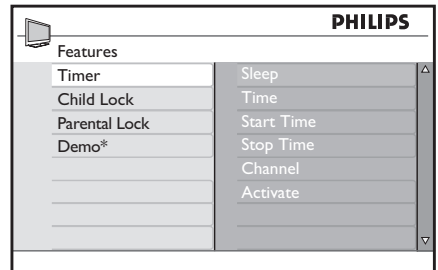

* Available in selected models

2. Press ► to enter the **Sleep** menu.
3. Press ▲ or ▼ to select the sleep time. If set to zero minute the sleep timer is switched off.
4. Press 确认 to activate the **Sleep** timer.

You can always switch off your TV earlier or reset the time during the countdown.

5.6.2 Automatically switch the TV on (Timer)

Timer switches the TV to a specified channel at a specified time, from standby. Your TV must be in standby for the timer to work.

1. Press 菜单 on the remote control and select **Features > Timer**.
2. Press ► to enter the **Timer** menu.
3. Use ▲ or ▼, ◀ or ▶ to select and enter the menu items to set a time, start time, stop time, channel, and frequency.
4. Press 确认 to confirm.
5. Press 菜单 to exit.

Tip

To switch off the timer, select **Off** in **Features > Timer > Activate**.

5.6.3 Lock TV channels (Parental Lock)

You can lock TV channels with a four digit code to prevent children from watching unauthorised content.

To set or change a PIN code

1. Press 菜单 on the remote control and select **Features > Parental Lock > Change code**.

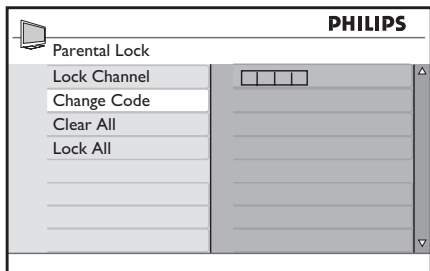

2. Press ▶ to enter the code setup.
3. Enter your code with the number keys. The **Features** menu reappears with a message confirming that your code is created or changed.

* Tip

If you forget your code, enter '0711' twice to override any existing codes.

To enter the Parental Lock menu

1. Press 菜单 on the remote control and select **Features > Parental Lock**.
2. Press ▶ to enter your code.
3. Enter your code with the number keys.

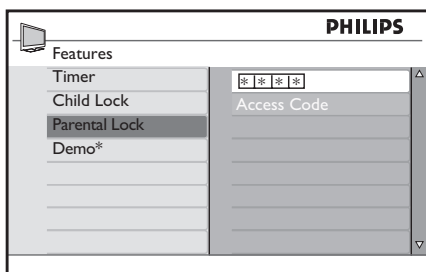

* Available in selected models

To lock or unlock all channels

1. In the **Parental Lock** menu, select **Lock All** or **Clear All**.
2. Press ▶ to enter.
3. Press 确认 to confirm your choice.

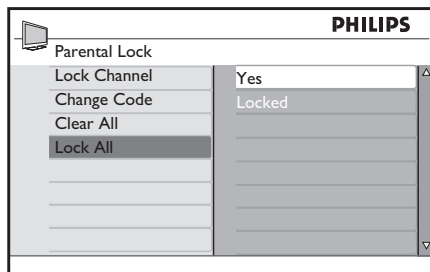

To lock one or more channels

1. Press 菜单 on the remote control and select **Features > Parental Lock > Lock Channel**.
2. Press ▶ to enter.
3. Press ▲ or ▼ to select the channels you want to lock.
4. Press 确认 to lock the channel. A 🔒 symbol appears next to the channel number. To unlock, press 确认 again.

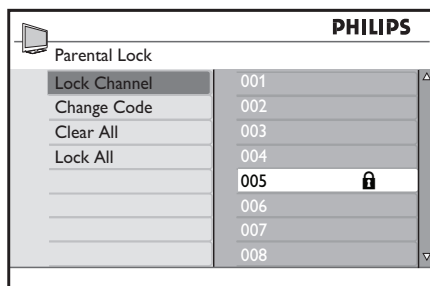

5. Repeat the above steps to lock or unlock more channels.

5.6.4 Lock the side controls (Child Lock)

You can lock the side controls of the TV to prevent children from changing channels. You can still change channel by using the remote control.

1. Press 菜单 on the remote control and select **Features > Child Lock**.
2. Press ▲ or ▼ to select **On** or **Off**.

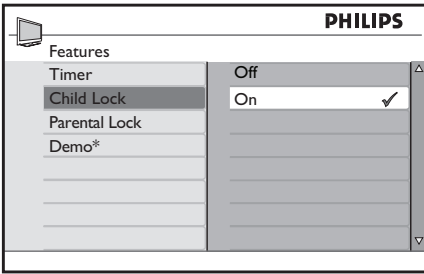

* Available in selected models

3. Press 确认 to confirm.
4. Press 菜单 to exit.

5.7 Use Demo mode

Demo mode is not available in all models. Consult your product specification to see whether your set has demo mode.

The demo mode enables you to see the difference between the new video technologies available on your TV and conventional TVs without these features.

1. Press 菜单 on the remote control and select **Features > Demo**.

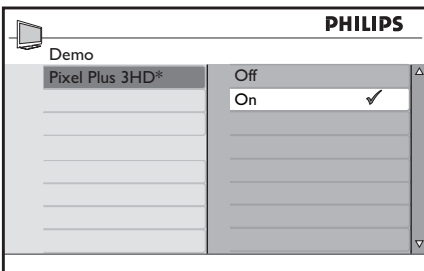
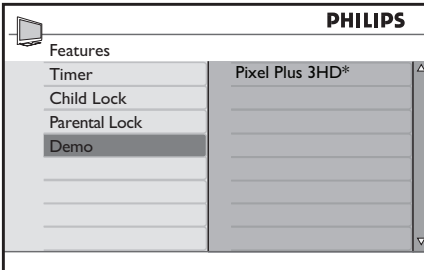

*Varies according to models.

Consult your product specification for details.

2. Press ▲ or ▼ to select **On** or **Off**.
3. Press 确认 to confirm.
4. Press 菜单 to exit.

Alternatively, you can turn on or off the **Demo** mode with the 演示 button on the remote control.

1. Press 演示 on the remote control. The **Demo** mode turns on.
2. Press 演示 again to turn off a demo.

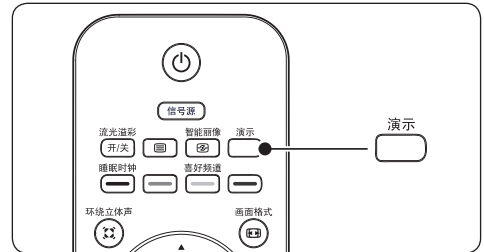

6 Install channels

This chapter describes how to install channels and tune channels.

6.1 Automatically install channels

This section describes how to search and store channels automatically.

Step 1 Select your menu language

1. Press 菜单 on the remote control and select **Install > Language**.

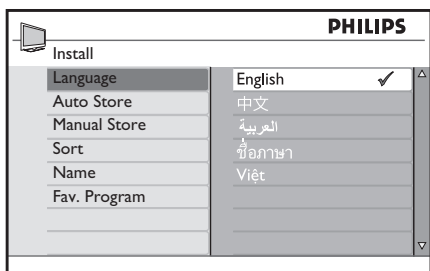

2. Press ▲ or ▼ to select your language.
3. Press 确认 to confirm.
4. Press 菜单 to exit.

Step 2 Install channels automatically

Your TV searches and stores all available TV channels.

1. Press 菜单 on the remote control and select **Install > Auto Store**.
2. Press 确认 to start installation. The installation may take a few minutes.
3. When the channel search is completed, the TV will go to the first installed channel number.
4. Press 菜单 to exit.

* Tip

To rename, reorder or uninstall stored channels, see *Section 6.3 Manage channels*.

6.2 Manually install channels

This section describes how to search and store analogue channels manually.

Step 1 Select your system

ⓘ Note

Skip to *Step 2 Search and store new TV channels* if your system settings are correct.

1. Press 菜单 on the remote control and select **Install > Manual Store**.

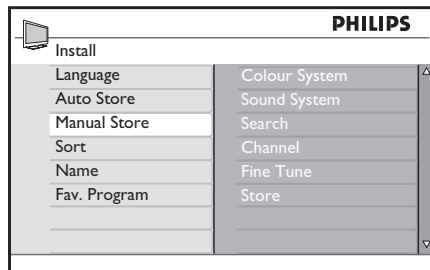

2. Press ► to enter **Manual Store**.
3. Press ► to enter **Colour System**.
4. Press ▲ or ▼ to select the appropriate system.
5. Press ◀ to return to the **Manual Store** menu.
6. Press ▼ to select **Sound System**.
7. Press ▲ or ▼ to select the appropriate system.
8. Press ▼ to select **Store** and ► to confirm.
9. Press ◀ to return to the **Manual Store** menu.

Step 2 Search and store new TV channels

1. Press 菜单 on the remote control and select **Install > Manual Store > Search**.

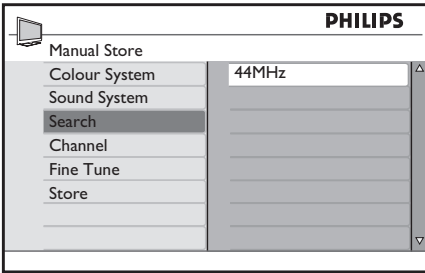

2. Press ► and the number keys on the remote control to manually enter the three-digit frequency.
3. Press ◀ when the new channel is found.
4. Press ▼ to select **Channel**.
5. Press ▲ or ▼ to select a channel number. Alternatively, use the number keys on the remote control to manually enter the channel number.
6. Press ▼ to store the new channel under a new channel number.
7. Press ► to enter.
8. Press 确认. **Stored** appears.
9. Press 菜单 to exit.

6.2.1 Fine tune channels

You can fine tune channels when reception is poor.

1. Press 菜单 on the remote control and select **Install > Manual Store > Fine Tune**.

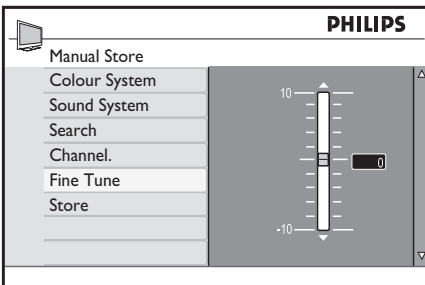

2. Press ▲ or ▼ to adjust the frequency

3. Press ◀ when done.
4. Select **Store** to store the fine tuned channel under the current channel number.
5. Press ► to enter.
6. Press 确认. **Stored** appears.
7. Press 菜单 to exit.

6.3 Manage channels

This section describes how to reorder, name, rename, or store favourite channels.

6.3.1 Reorder channels

1. Press 菜单 on the remote control and select **Install > Sort**.
2. Press ▲ or ▼ to select the channel you want to reorder.

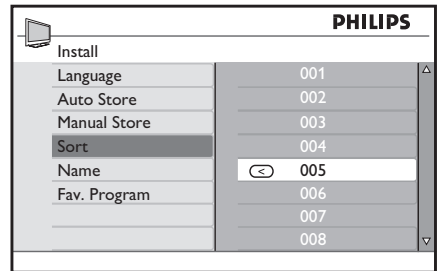

3. Press ► to confirm.
4. Press ▲ or ▼ to select the channel you want to change to.
5. Press ◀ to confirm.

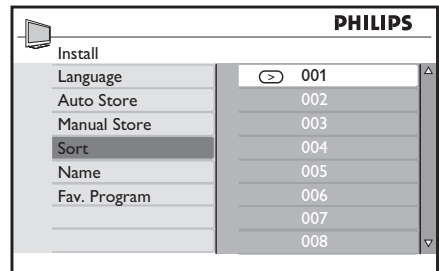

6. Repeat the above steps to reorder more channels.

7. Press 菜单 to exit.

6.3.2 Name or rename channels

This feature is not available for external channels.

1. Press 菜单 on the remote control and select **Install > Name**.
2. Press ▲ or ▼ to select the channel you want to rename.
3. Press ► to start the process.
4. Press ▲ or ▼ to select the characters or numbers from the list. You can use up to five characters or numbers.
5. Press ◀ to end the process.
6. Repeat the above steps to name or rename more channels.
7. Press 菜单 to exit.

6.3.3 Store your favourite channels

You can specify a list of favourite channels.

When you use the 音量 - / + keys of the remote control to access channels, only the favourite channels are accessed.

To access channels that are not in your list of favourites, use the 0 to 9 numerical keys.

Add or remove channels from your list of favourites

1. Press 菜单 on the remote control and select **Install > Fav. Program**.

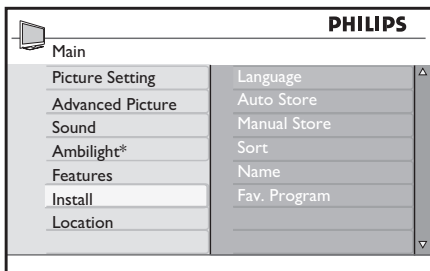

* Available in selected models

2. Press the ▲ or ▼ to select the channel

number you want to add or remove from the list.

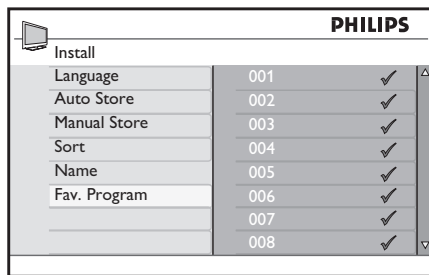

3. Press ► or 确认 to add or remove the channel from your list.

⊖ **When** the ✓ is displayed on the right of the menu, the channel is in the list of favourites.

When the ✓ is not displayed on the right of the menu, the channel is not in the list of favourites.

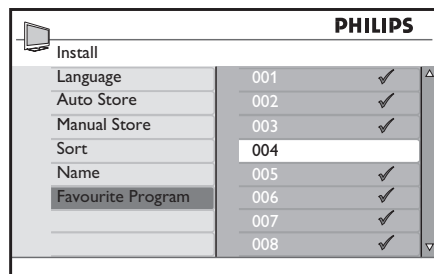

4. Press the ◀ key to return to the previous menu.
5. Press 菜单 to exit.

6.4 Change to Shop or Home mode

1. Press 菜单 on the remote control and select **Location**.
2. Press ► to enter the **Location** menu.
3. Use ▲ or ▼ to select the TV mode:

• Shop

Sets smart settings to **Vivid**, ideal for

a shop environment. The flexibility to change settings is limited.

- **Home**

Gives home users the full flexibility to change all TV settings.

4. Press 确认 to confirm.

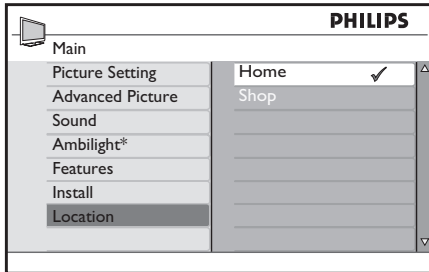

5. Press 菜单 to exit.

7 Connect devices

7.1 Connection overview

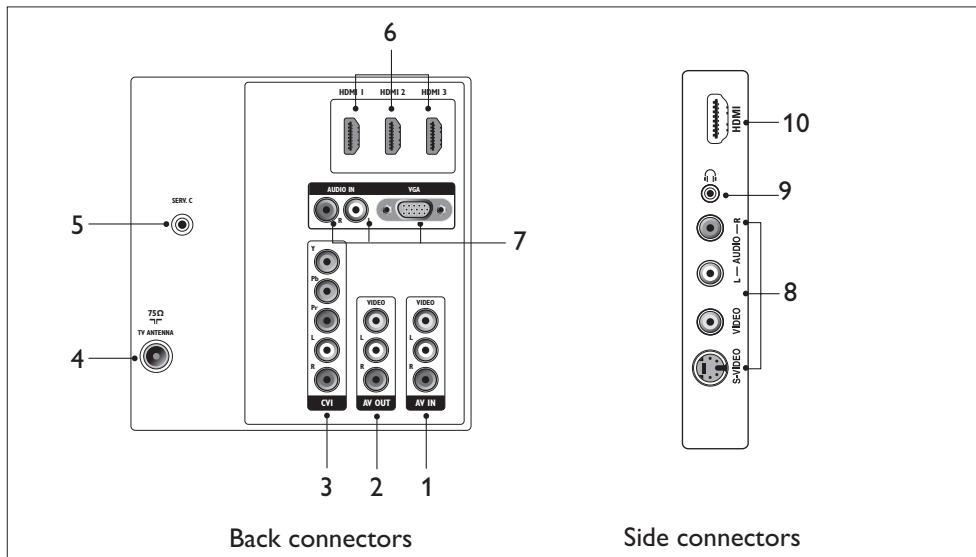

Back connectors

- 1. AV IN**
Video and audio input cinch connectors for connection to devices.
- 2. AV OUT**
Video output cinch connector and audio L/R connectors for connection to devices.
- 3. CVI**
Component video (Y Pb Pr) and Audio L/R input connectors for DVD players, digital receivers, game consoles and other component video devices.
- 4. TV ANTENNA**
Aerial plug connector.
- 5. SERVO C**
For service use (do not insert the headphone here).
- 6. HDMI 1/2/3** (available in selected models)
HDMI input connectors for Blu-ray Disc players, digital receivers, game consoles and other high-definition devices.

7. VGA/AUDIO IN

Input connectors for PC or other devices. Audio connectors are also for devices that require a separate audio channel.

Side connectors

- 8. AUDIO L/R**
Audio L/R input connectors for composite and S-Video devices.
- 9. Headphones**
Stereo mini jack.
- 10. HDMI** (available in selected models)
Additional HDMI connector for mobile high-definition devices.

7.2 Select connection quality

This section describes how you can enhance your audio visual experience by connecting your devices with the best possible connectors.

After connecting your devices, be sure to enable them as described in *Section 7.4 Setup devices*.

7.2.1 HDMI - Highest quality

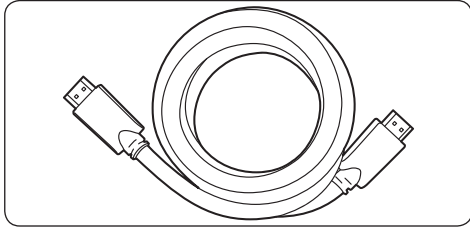

HDMI produces the best audio visual quality possible. Both audio and video signals are combined in one HDMI cable, providing an uncompressed, digital interface between your TV and HDMI devices. You must use HDMI to experience full high-definition video.

❁ Tip

If your device only has a DVI connector, use a DVI-HDMI adaptor to connect your device to a HDMI connector on the TV. As such a connection does not support sound, you must connect a separate audio cable from the device to the Audio L/R input at the **AUDIO IN** connectors on the TV.

⊖ Note

Philips HDMI supports HDCP (High-bandwidth Digital Contents Protection). HDCP is a form of Digital Rights Management that protects high definition content in DVD or Blu-ray Discs.

7.2.2 Component (YPbPr) - Higher quality

Component (Y Pb Pr) video provides better picture quality than S-Video or composite video connections. Though component video

supports high-definition signals, picture quality is lower than HDMI and is analogue.

When connecting a component video cable, match the cable colours to the **CVI** connectors on the back of the TV. Also, connect a Audio L/R cable to the white and red Audio L/R input connectors at **CVI**.

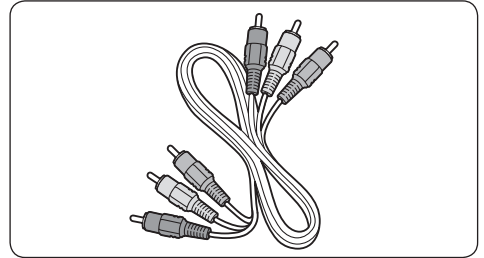

Component video cable - Red, green, blue

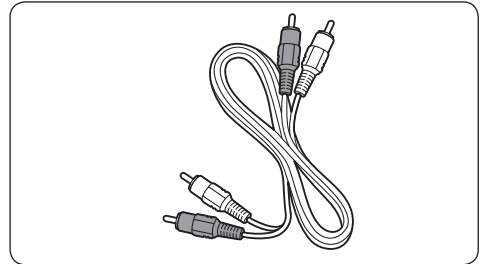

Audio L/R cable - White and red

7.2.3 S-Video - Good quality

S-Video provides better picture quality than composite video. When connecting your device with S-Video, plug the S-Video cable to the S-Video connector on the side of the TV. You must connect a separate Audio L/R cable from the device to the white and red Audio L/R input connectors on the side of the TV.

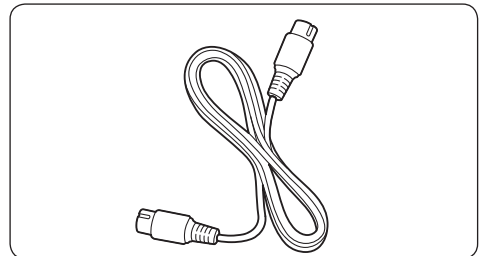

S-Video cable

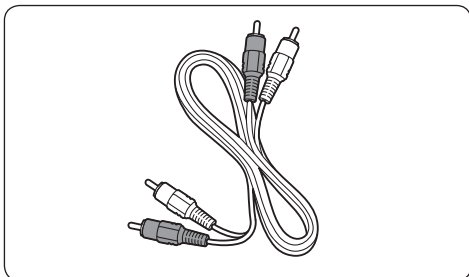

Audio L/R cable - White and red

7.2.4 Composite - Basic quality

Composite video provides basic analogue connectivity, usually combining a (yellow) video cinch cable with (white and red) Audio L/R cinch cable. Match the cable colours when connecting to the composite Video and Audio L/R input connectors on the side of the TV.

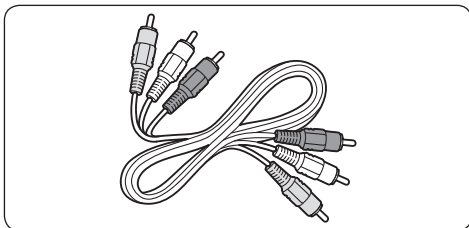

Composite audio/video cable- Yellow, white and red

7.3 Connect devices

This section describes how to connect a selection of devices. Note that different types of connectors may be used to connect a device to your TV, depending on availability and your needs. The following sections are examples only.

7.3.1 Indoor antenna

Connect an antenna cable from the TV to the indoor antenna.

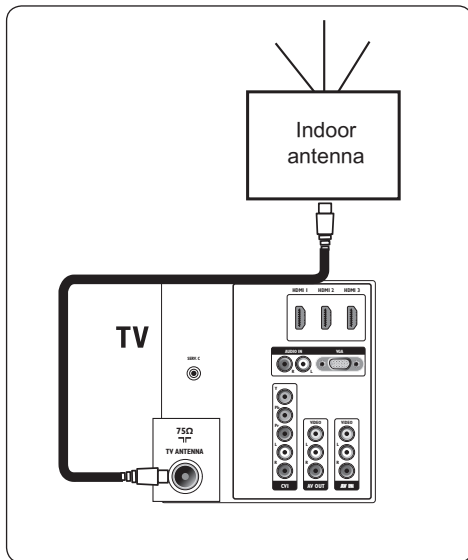

7.3.2 Blu-ray Disc player

For full high-definition video, connect a HDMI cable to the Blu-ray Disc player or a HD game console and a HDMI connector on the back or side of the TV (available in selected models).

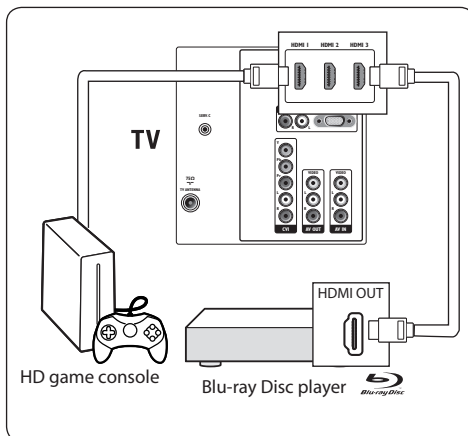

7.3.3 DVD player/Home theatre system

Connect a component video cable from the DVD player to **CVI** connectors on the back of your TV.

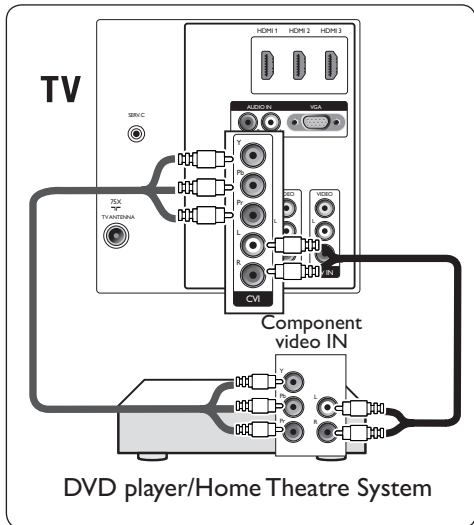

7.3.4 VCR

Connect a composite video cable from the player to the **AV IN** connectors on the back of the TV. For recording of TV programmes on a VCR, connect to the **AV OUT** connectors.

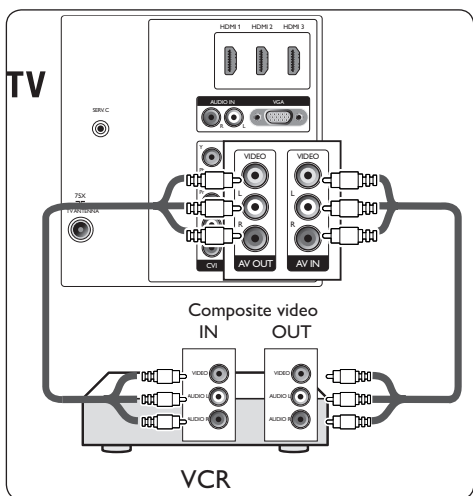

7.3.5 DVD recorder

To receive channels via an indoor antenna and record analogue programs on a DVD recorder, connect an antenna cable to the TV and a component video cable from the DVD recorder to your TV. .

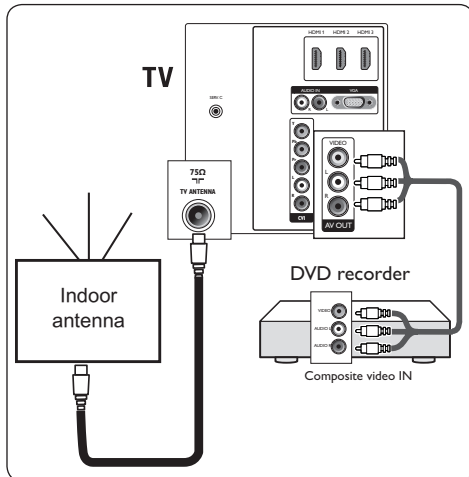

7.3.6 Game console or camcorder

The most practical connection for a mobile game console or camcorder may be at the side of the TV. You can, for example, connect the game console or camcorder to VIDEO/S-Video and AUDIO L/R connectors at the side of the TV. An HDMI connector is also available for high-definition devices.

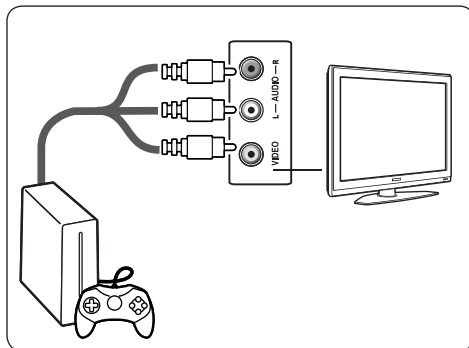

A permanent game console or camcorder can be connected to an HDMI connector or **AV IN** (component) connectors at the back of the TV.

7.3.7 Personal Computer

⚠ Caution

Before connecting the PC, set the PC monitor refresh rate to 60Hz. See *Section 11 Technical data* for a list of computer resolutions.

Connecting to the back of the TV (VGA)

1. Connect your PC to the VGA connector at the back of the TV.
2. Connect an audio cable from your PC to AUDIO IN L/R connectors on the back of the TV.

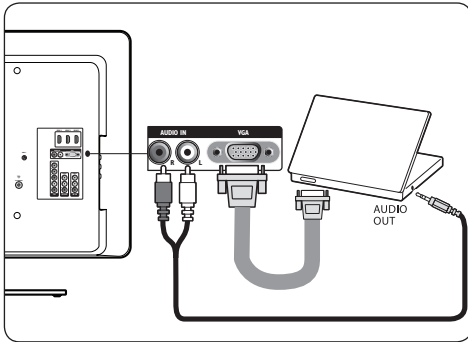

Connecting to the side of the TV (S-Video)

If your PC has no VGA connection, use the S-VIDEO and AUDIO L/R input connectors at the side of the TV. This type of connection is best suited to applications such as Windows Media Center.

7.4 Setup devices

When all devices are connected, you must select the type of device attached to each connector.

7.4.1 Select connectors

To select the device connected to the connectors on your TV.

1. Press 信号源 on the remote control.

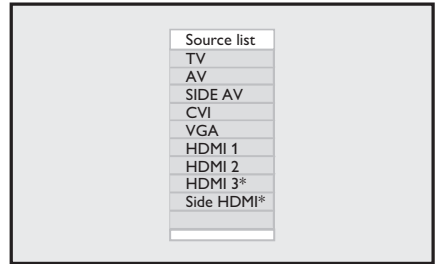

* Available in selected models

2. Press ▼ or ▲ to select a connector.
3. Press 确认 to confirm.
4. Repeat the above steps to select another connector.

8 Use your TV as PC monitor

8.1 Configure PC mode

1. Connect your computer in *Section 7.3.7 Personal Computer*.
2. Press 信号源 on the remote control.

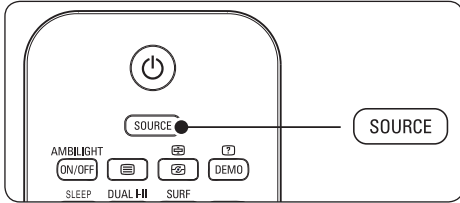

The list of sources appears.

3. Press ▼ to select **VGA** and press **OK** to confirm.

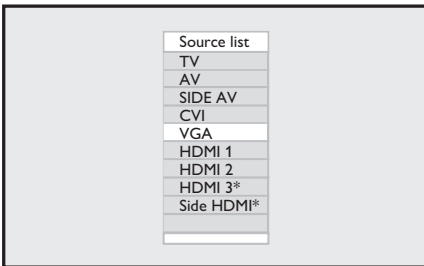

* Available in selected models

 **Note:** Set your PC refresh rate to 60 Hz.

Picture settings in PC mode

Except for Horizontal Shift and Vertical Shift, all of the picture settings in PC mode are the same as the picture settings in TV mode.

- **Horizontal Shift**
To adjust horizontal position of the range.
- **Vertical Shift**
To adjust vertical position of the range.

Feature settings in PC mode

- **Phase and Clock**
To match the TV and computer display settings

- **Auto Adjust**
To synchronise the TV and computer Phase and **Clock** rate automatically. The geometry is also adjusted.
- **Reset**
To return to default settings.

9 Use your TV in High Definition (HD) mode

The HD (High Definition) mode allows you to enjoy clearer and sharper pictures if you are using HD equipment that can produce high definition video signals.

9.1 Configure HD mode

1. Connect your HD equipment as shown in the *Quick Start Guide*
2. Press 信号源 on the remote control.

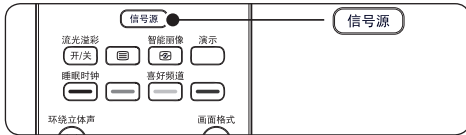

The list of sources appears.

3. Press ▼ to select the correct **HDMI** and press 确认 to confirm.

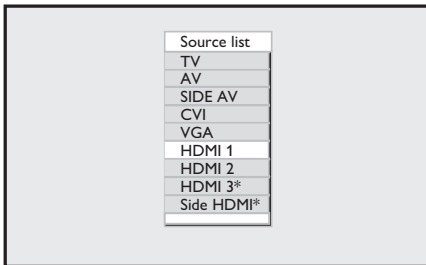

* Available in selected models

4. Press 菜单 to display the on-screen menus.
5. Go to **Features > Mode Selection**.
6. Press ▼ and 确认 to select **HD**.

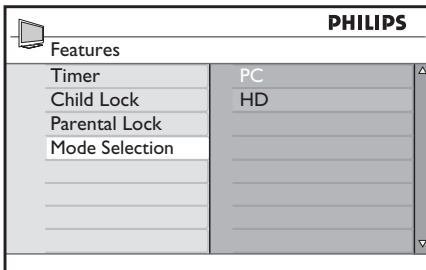

7. Press **MENU** to exit.

Picture settings in HD mode

Except for Horizontal Shift and Vertical Shift, all of the picture settings in PC mode are the same as the picture settings in TV mode.

- **Horizontal Shift**
To adjust horizontal position of the range.
- **Vertical Shift**
To adjust vertical position of the range.

Sound settings in HD mode

All the sound settings in PC mode are the same as the sound settings in TV mode.

9.2 Configure the TV in HD mode

You must configure the TV in HD mode when you connect a HD equipment that supports the following resolutions: 480p, 720p or 1080p.

The **Features** menu includes the **Mode Selection** option and the **Format** option.

1. Press the 菜单 key to display the **Main** menu.
2. Press the ▲ or ▼ key to select **Features**, and press the ► or 确认 to enter the menu.
3. Press the ▼ key to select **Mode Selection**, and press ► or 确认 to enter the setting.

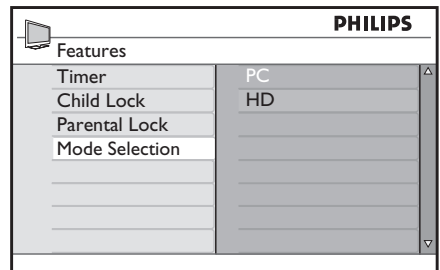

4. Press the ▲ or ▼ key to select **HD**.
5. Press the ◀ key to return to the previous menu.

6. Press the 菜单 key to exit the menu.

9.3 Display in native 1080 mode

⊖ **Note:** Only TVs with the full HD 1080p can display in native 1080 mode.

When you connect HD equipment that supports a resolution of 1080i or 1080p, the Display (native 1080) feature is available in the Features menu. This feature allows you to watch the original HD format in 1080i/p mode.

1. Press the 菜单 key to display the **Main** menu.
2. Press the ▲ or ▼ key to select **Features**, and press the ► or 确认 key to enter the menu.
3. Press ▼ key to select **Display**.

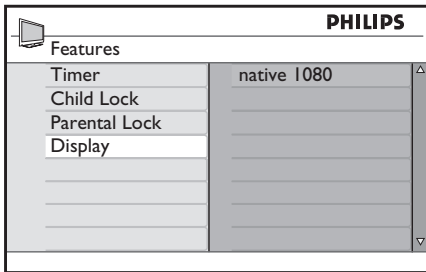

4. Press the ► key to access **Display**.
5. Press the ► key twice to access the **Off/On** option in the **native 1080**.

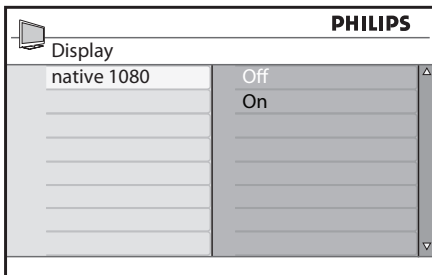

6. Press the ▲ ▼ keys to select **Off** or **On**. Select **On** option to watch native 1080 mode.
7. Press the ◀ key to return to the previous menu.

8. Press the 菜单 key to exit the menu.

9.4 Supported formats

The following table list the supported input formats for HD mode.

Non 1080p models				
HD format	480p	576p	720p	1080i
SD format	480i		576i	

1080p models					
HD format	480p	576p	720p	1080p	1080i
SD format	480i		576i		

⊖ **Note:** Your Philips TV is HDMI compliant. If you do not get a good picture, please change the video format on your peripheral devices. Refer to the table above for details.

10 Use Philips EasyLink

Your TV is enabled for HDMI-CEC connections with other devices. The following descriptions apply to devices that are CEC-compliant and connected to your TV through an HDMI cable.

One-touch play

When you connect your TV to devices that support One-touch play, you can control your TV and the devices with one remote control. For example, when you press one-touch play on your DVD's remote control, your Philips TV will automatically switch to the correct channel to show the DVD content.

One-touch standby

When you connect your TV to devices that supports one-touch standby, you can use your TV's remote control to put the devices to standby. To put a device into standby, press and hold the  button on the TV's remote control for 3-4 seconds.

11 Technical data

Supported display resolutions

- **HDMI Input:**

Mode	Signal Format
PC Format	640x480@60Hz, 72Hz, 75Hz, 85Hz 720x400@70Hz, 85Hz 800x600@60Hz, 72Hz, 75Hz, 85Hz 1024x768@60Hz, 70Hz, 75Hz, 85Hz 1280x768@60Hz 1280x1024@60Hz

Video Format	720x480p@60Hz 720(1440)x480i@60Hz 720x576p@50Hz 720x(1440)x576i@50Hz 1280x720p@60Hz 1280x720p@50Hz 1920x1080i@50Hz, 60Hz 1920x1080p@24Hz, 25Hz, 30Hz, 50Hz, 60Hz
--------------	---

- **PC Analog, D-sub input:**

Mode	Signal Format
PC Format	640x480@60Hz, 72Hz, 75Hz, 85Hz 720x400@70Hz, 85Hz 800x600@60Hz, 72Hz, 75Hz, 85Hz 1024x768@60Hz, 70Hz, 75Hz, 85Hz 1280x768@60Hz 1280x1024@60Hz

- **Tuner / Reception / Transmission**

- Antenna input: 75ohm coaxial (IEC75)
- TV system: PAL I, PAL B/G, PAL D/K, SECAM B/G, SECAM D/K
- Video playback: NTSC, SECAM, PAL

Sound

- Sound mode: Mono, Stereo, Incredible Surround, BBE

Remote control

- Batteries: 2 x AAA size (R03 type)

Connections (Rear)

- AV IN: Audio L/R, Video
- AV OUT: Audio L/R, Video
- CVI: Component (Y Pb Pr), Audio L/R in
- *HDMI 1/2/3
- VGA
- TV ANTENNA

Connections (Side)

- Headphone out (stereo mini jack)
- AUDIO L/R in
- Video (CVBS) in
- S-Video
- *HDMI

Power

- Mains power: AC 220-240V
- Power and standby power consumption: See technical specifications at www.philips.com
- Ambient temperature: 5°C - 35°C

Specifications are subject to change without notice. For detailed specifications of this product go to www.philips.com/support.

* available in selected models.

12 Troubleshooting

This section describes commonly-encountered issues and accompanying solutions.

12.1 General TV issues

The TV does not switch on:

- Unplug the mains cord, wait for one minute and plug in the mains again.
- Verify that the mains cord is properly connected and that the mains are powered.

The remote control is not working properly:

- Verify that the remote control batteries are correctly inserted according to the +/- orientation.
- Replace the remote control batteries if they are flat or weak.
- Clean the remote control and TV sensor lens.

The standby light on the TV blinks red:

- Turn off the TV and unplug the mains cord. Wait until the TV cools down before reinserting the mains cord and turning on the TV. If the blinking occurs again, contact our Customer Support Centre.

You forgot your code to unlock channels

Enter '0711' as described in *Section 5.6.3 Lock TV channels (Parental Lock)*.

The TV menu is in the wrong language

See *Section 6* for instructions on how to change the TV menu to your preferred language.

12.2 Picture issues

There is sound but no picture:

- Verify that picture settings are correctly set. See *Section 5.3.1 Adjust picture settings*.

You receive poor TV reception from an antenna connection:

- Check that the antenna is properly connected to the TV.
- Loud speakers, non-earthed audio devices, neon lights, high buildings or mountains can influence the picture quality. Try to improve the reception quality by changing the antenna direction or moving devices away from the TV.
- Verify if the correct TV system is selected for your region. See *Section 6.2 Manually install channels*.
- If reception on only one channel is poor, try to fine tune this channel. See *Section 6.2.1 Fine tune channels*.

You receive poor picture quality from connected devices:

- Check that the devices are connected properly. Also, be sure to assign devices to connectors as described in *Section 7.4 Setup devices*.
- Verify that picture settings are correctly set. See *Section 5.3.1 Adjust picture settings*.

The TV did not save my settings:

- Verify that the TV is set to the Home location, which offers you complete flexibility to change settings. See *Section 6.4 Change to Shop or Home mode*.

The picture does not fit the screen, it is too big or too small:

- Try using a different picture format as described in *Section 5.3.3 Change picture format*.
- Assign your device to connectors as described in *Section 7.4 Setup devices*.

12.3 Sound issues

There is picture but no sound from the TV:

Note

If no audio signal is detected, the TV automatically switches off audio output and does not indicate malfunction.

- Check that all cables are properly connected.
- Check that the volume is not set to 0.
- Check that the sound is not muted.

There is a picture but sound quality is poor:

- Check sound settings as described in *Section 5.3.4 Adjust sound settings*. Verify that Stereo and Equalizer settings are correct.

There is a picture but sound comes from one speaker only:

- Verify that the **Balance** is correctly set, as described in *Section 5.3.4 Adjust sound settings*.

12.4 HDMI connection issues

You encounter problems with HDMI devices

- The HDMI - HDCP procedure might take a few seconds before the TV shows the picture from a device.
- If the TV does not recognise the device and the screen shows no picture, try switching from one device to another and back again to restart the HDCP procedure.
- If you experience intermittent sound disruptions, check the user manual of the HDMI device to verify that output settings are correct. Alternatively, try connecting the channeling of the audio signal from the HDMI device to the TV via an additional audio cable.
- If a HDMI-to-DVI adaptor or HDMI to DVI cable is used, check that an additional audio connection is in place to complete the DVI connection.

12.5 PC connection issues

The PC display on my TV is not stable or is not synchronised:

- Check that a supported resolution and refresh rate is selected on your PC. See *Section 11 Technical data* for supported resolutions and refresh rates.
- Adjust the screen resolution in your PC.

12.6 Contact us

If you cannot solve your problem, contact the Customer Support Centre in your country as listed on the last page of this user manual. Alternatively, consult our website at www.philips.com/support.

WARNING

Do not attempt to repair the TV yourself. This may cause severe injury, irreparable damage to your TV and void your warranty.

Note

Please have available your TV model, product number and serial number before contacting us. These numbers are available on your TV as well as on the packaging accompanying your TV.

