

# PHILIPS

## Television

### Quick Start Guide

5214U series

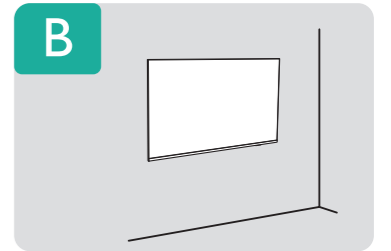
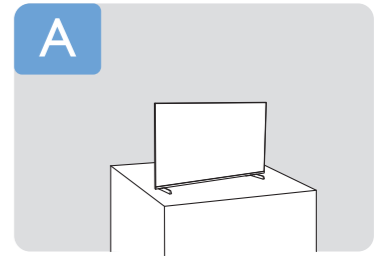
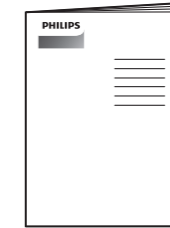
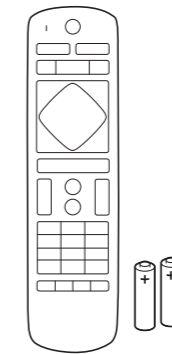
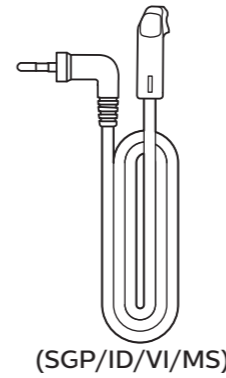
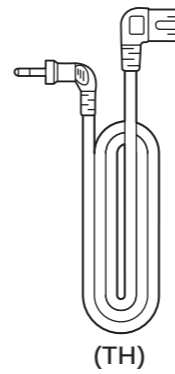
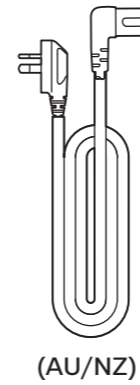
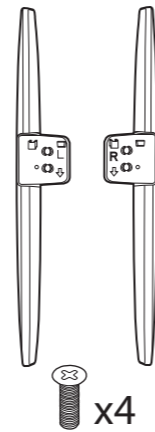
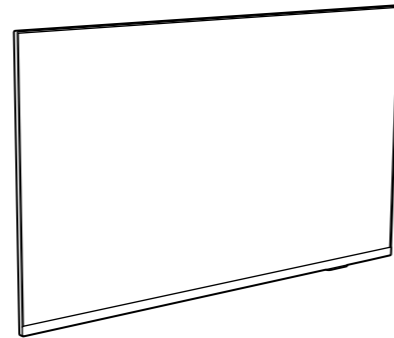

A

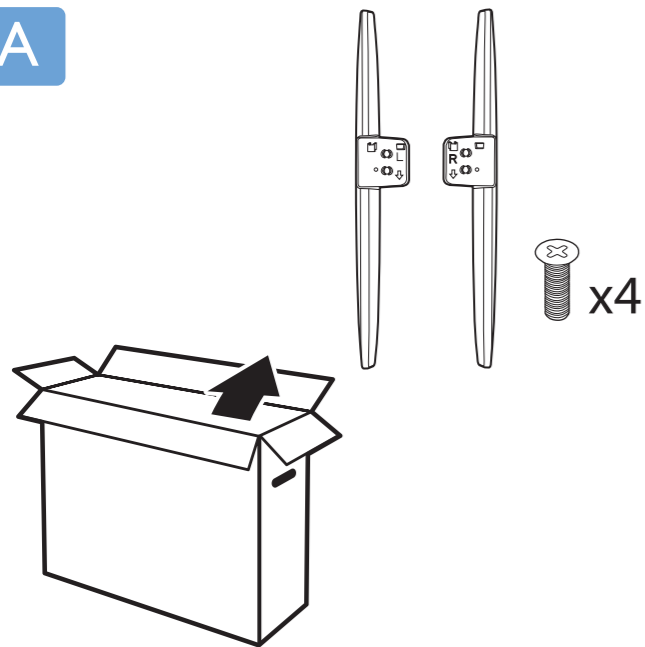

1

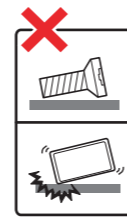
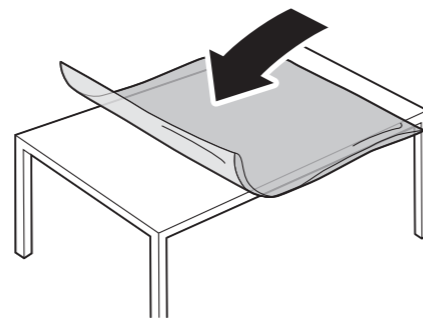

3

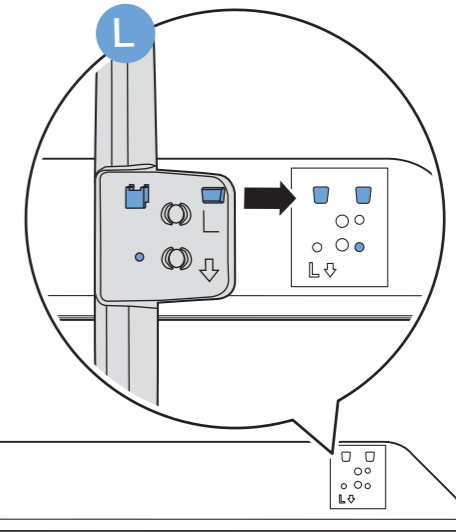
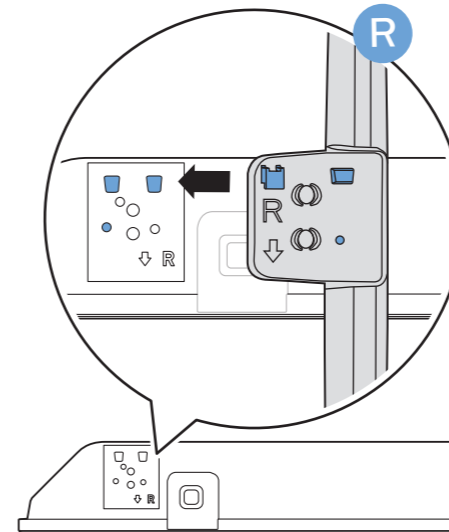

4

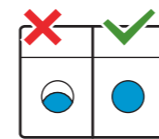
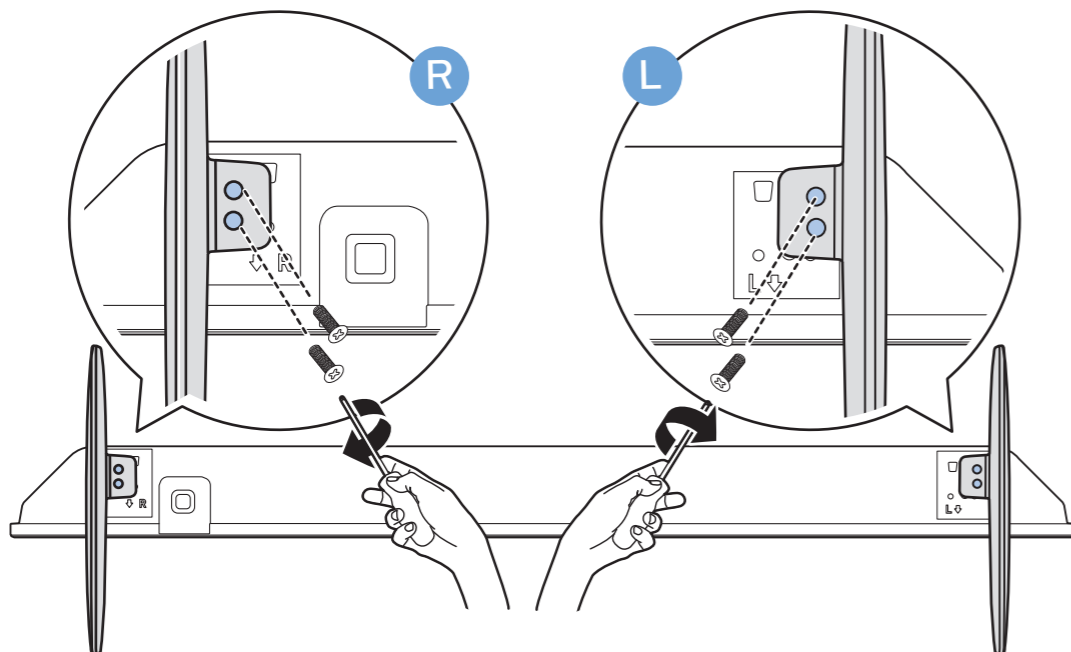

5

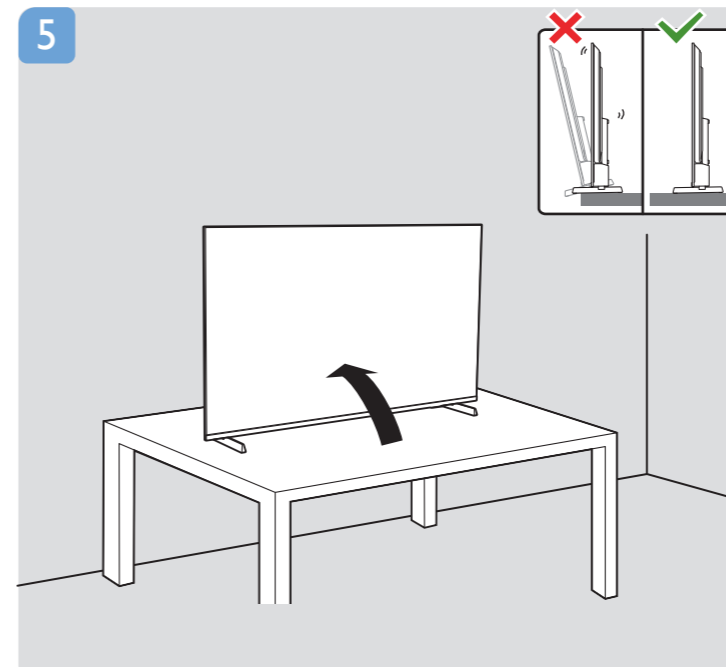

B

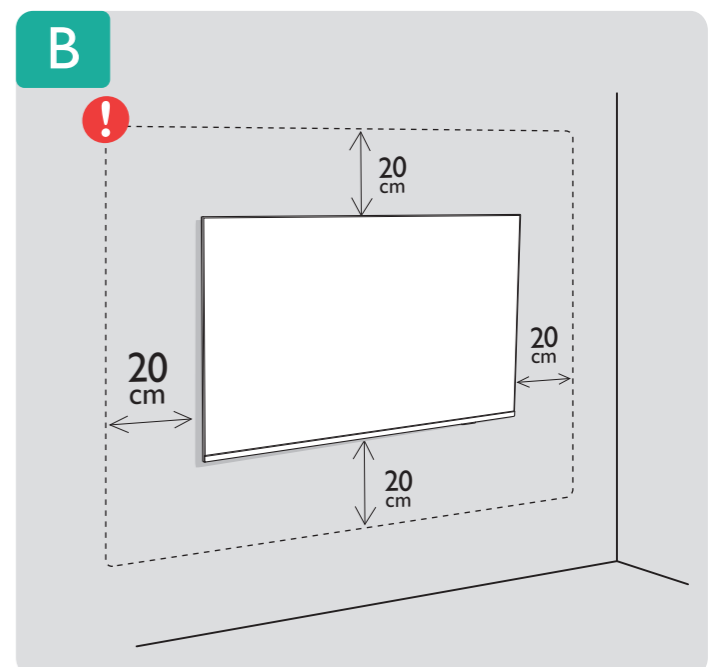



1

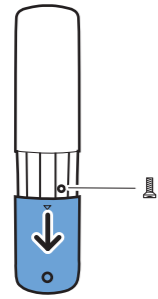

2

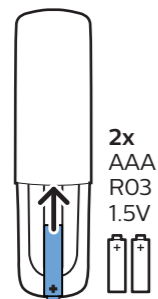

2x  
AAA  
R03  
1.5V

3

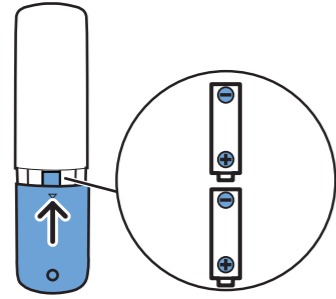

4

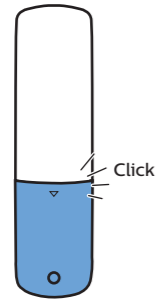

Click

5

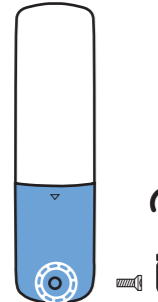

### VESA (x,y)

55" 200x200mm M6  
(L: 14mm~16mm) 139 cm

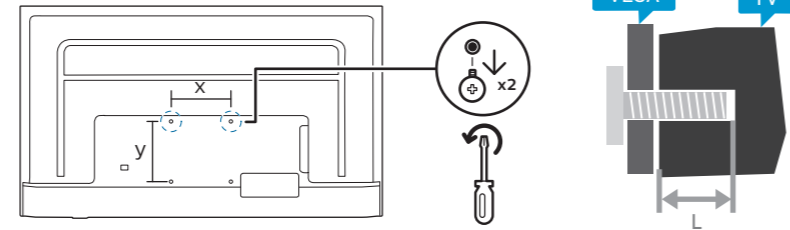

**English** Read the safety instructions.

**Bahasa Malaysia** Baca arahan Keselamatan.

**Bahasa Indonesia** Baca petunjuk keselamatan.

**Deutsch** Lesen Sie die Sicherheitshinweise.

**Français** Lisez les consignes de sécurité.

**ภาษาไทย** โปรดอ่านคำแนะนำด้านความปลอดภัย

**Tiếng Việt** Hãy đọc chỉ dẫn an toàn.

**简体中文** 请阅读安全说明。

**繁體中文** 請閱讀安全說明。

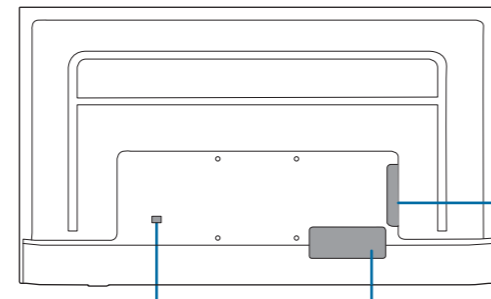
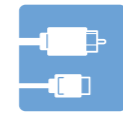

USB 1

HDMI 1  
ARC

POWER  
(AU/NZ)

POWER  
(SGP/ID/VI/MS)

POWER  
(TH)

NETWORK

TV  
ANTENNA

8Ω  
AUDIO  
OUT

DATA

USB 2

HDMI 2/3  
ARC

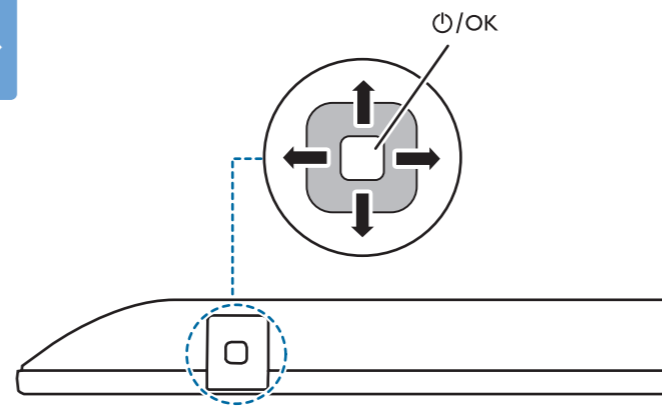
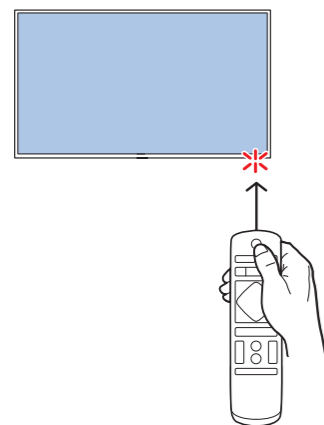
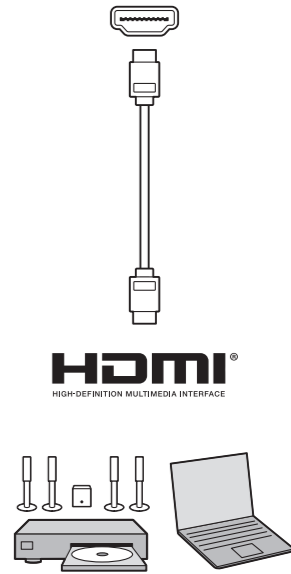
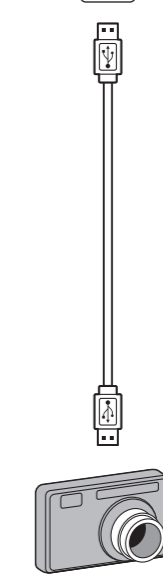
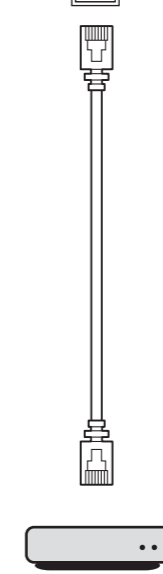
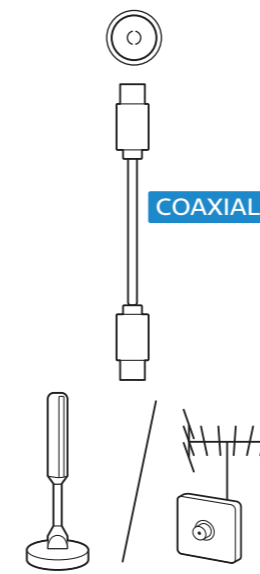
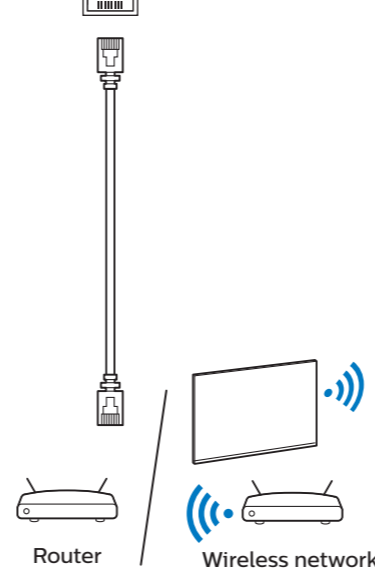
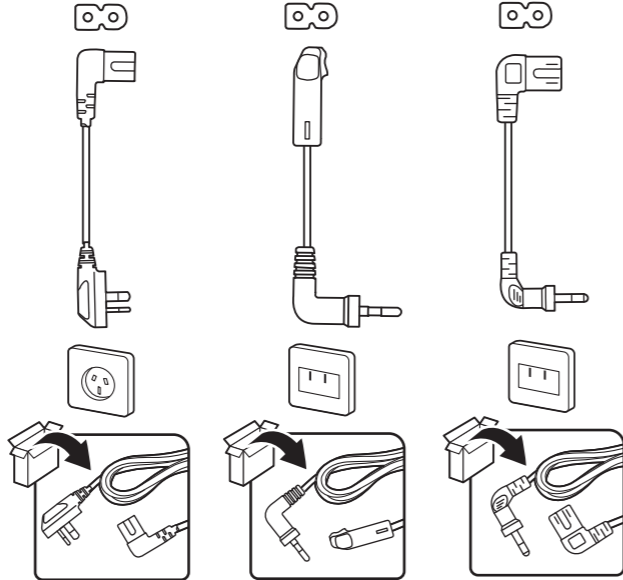

[www.philips.com/support](http://www.philips.com/support)  
5214U Series  
User Manual

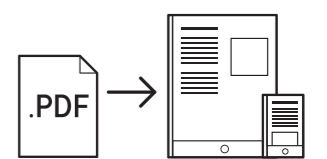

All registered and unregistered trademarks are property of their respective owners. Specifications are subject to change without notice. Philips and the Philips' shield emblem are trademarks of Koninklijke Philips N.V. and are used under license from Koninklijke Philips N.V. This product has been manufactured by and is sold under the responsibility of Top Victory Investments Ltd. (or one of its related affiliates), and Top Victory Investments Ltd. (or one of its related affiliates), is the warrantor in relation to this product. 2021© TOP Victory Investments Ltd. All rights reserved.