

Register your products and get support at  
[www.philips.com/welcome](http://www.philips.com/welcome)

6100 Series

# Quick start guide

**PHILIPS**



**English**

Before using your product, read all accompanying safety information.  
(The relevant parameters of instructions are variable, without prior notice, if there is any discrepancy, please in accordance with actual object.)

**Bahasa Melayu**

Baca semua maklumat keselamatan yang disertakan sebelum menggunakan produk anda.  
(Parameter arahan yang berkenaan boleh berubah tanpa notis terdahulu, jika ada percanggahan, sila gunakan parameter pada objek sebenar.)

**简体中文**

使用产品前，请阅读所有附带的安全信息。  
(指南内容相关的参数是可变的，恕不另行通知，如果有差异，请以实物为准。)



English What's in the box  
Bahasa Melayu Barang-barang di dalam kotak  
简体中文 包装箱清单

(43"/49"/55")

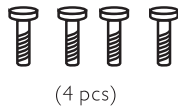
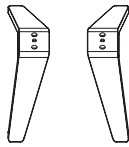
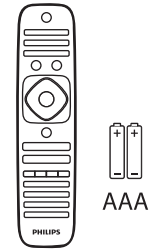
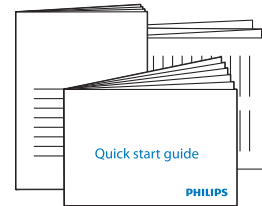
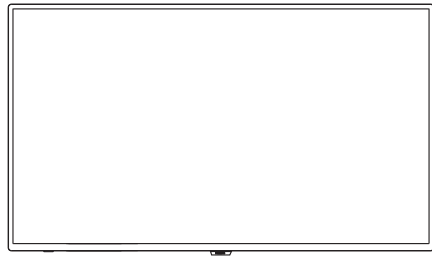

1



English Mount the stand  
Bahasa Melayu Pasang kaki  
简体中文 底座安装方式

(43"/49"/55")

1

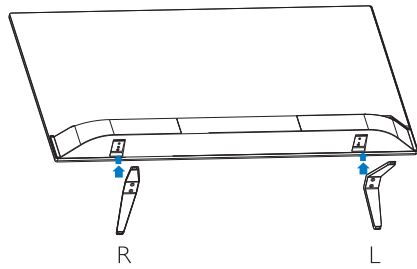

2

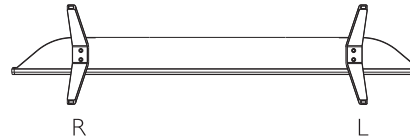

3

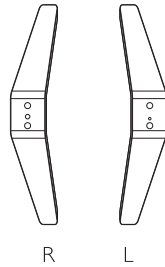
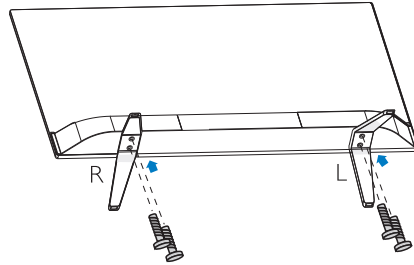

# 2

English      Connect  
Bahasa Melayu      Sambungkan  
简体中文      连接

(43"/49"/55")

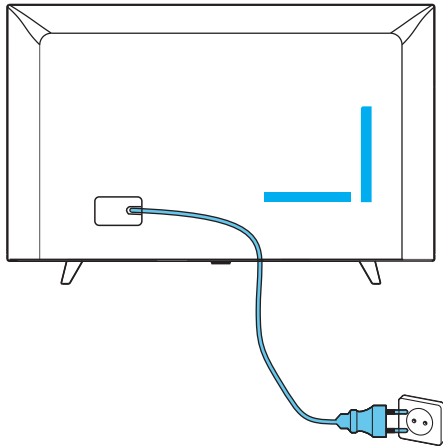

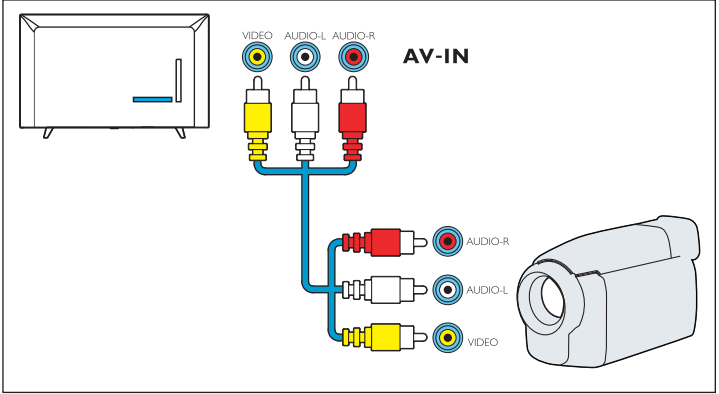
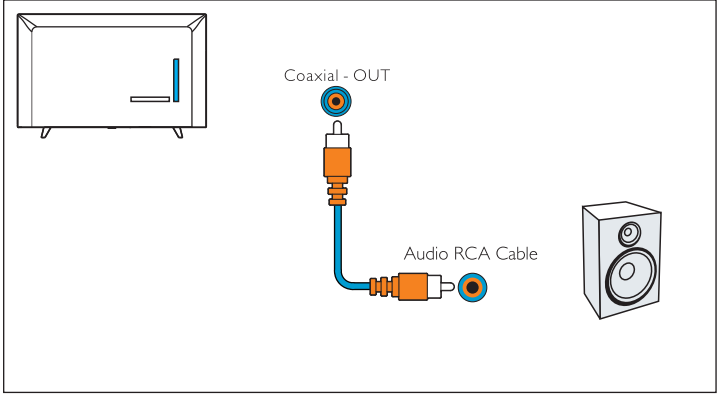
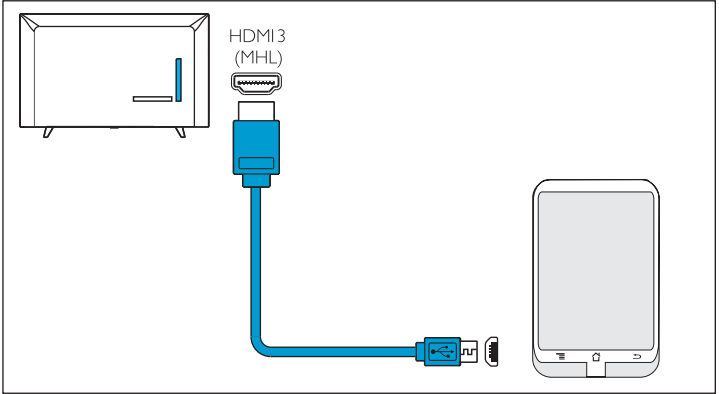
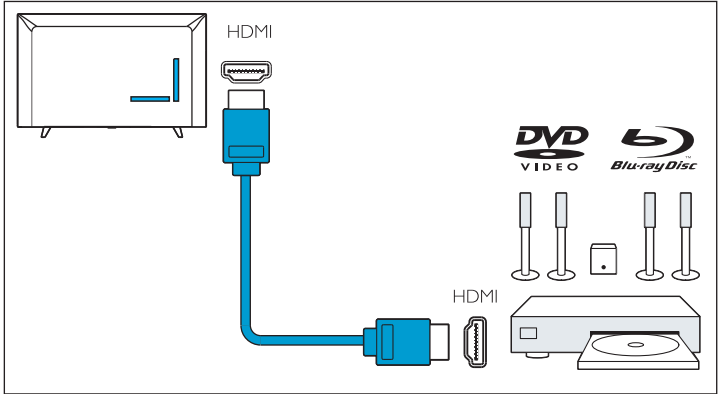

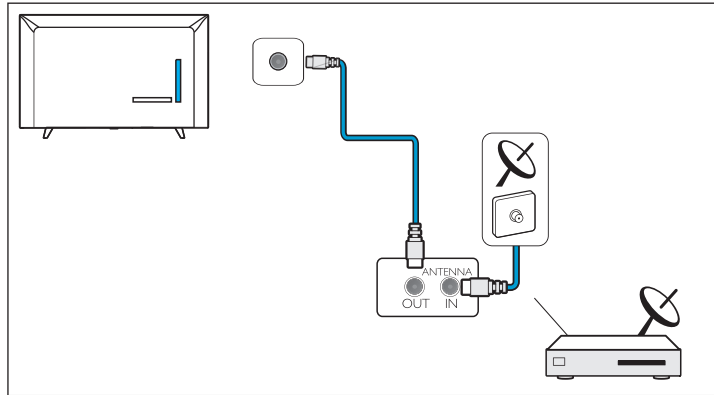
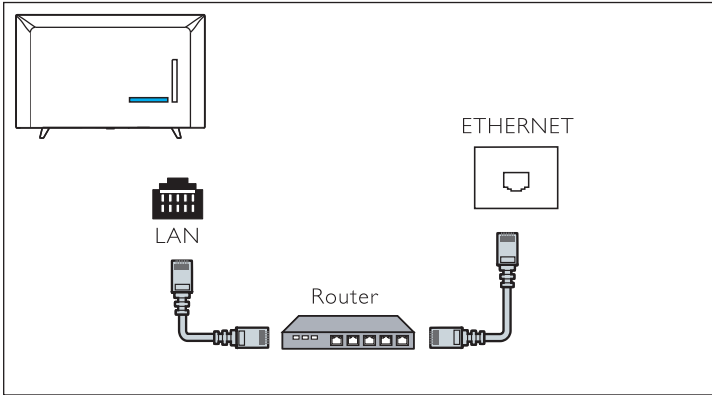
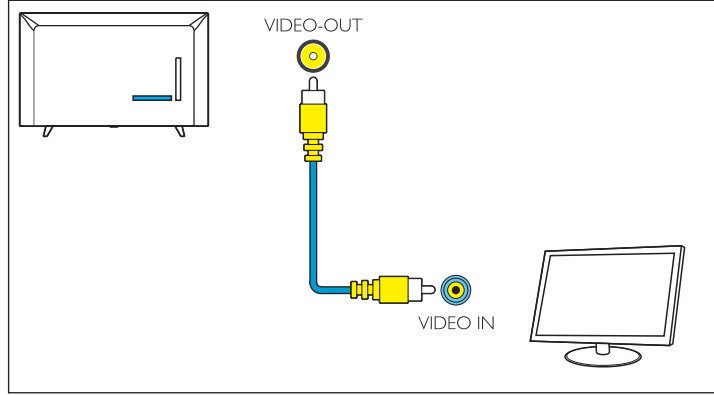
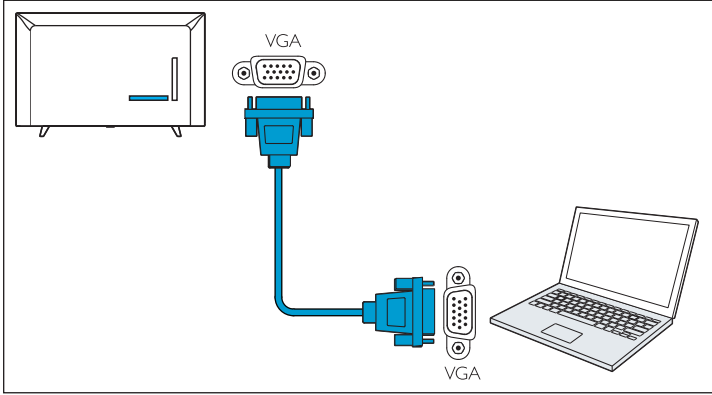

# 3

English  
Bahasa Melayu  
简体中文

Insert batteries  
Masukkan bateri  
安装电池

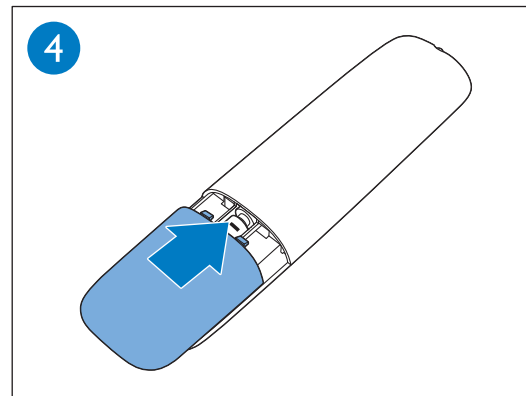
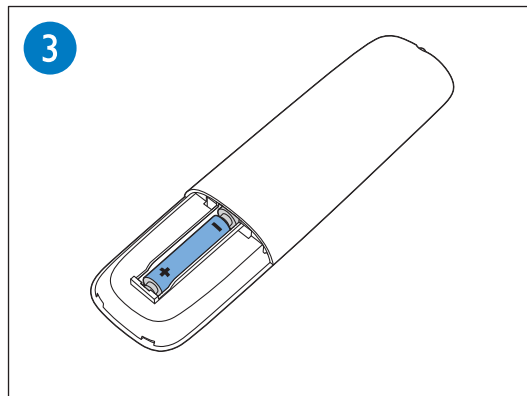
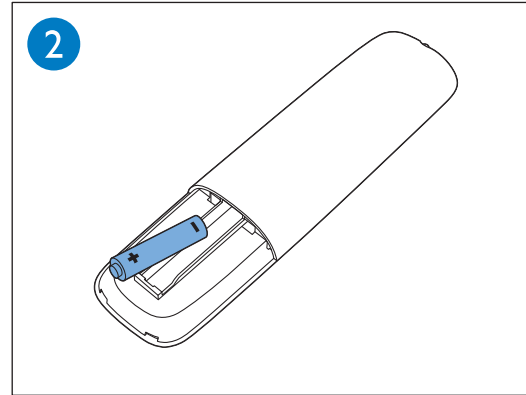
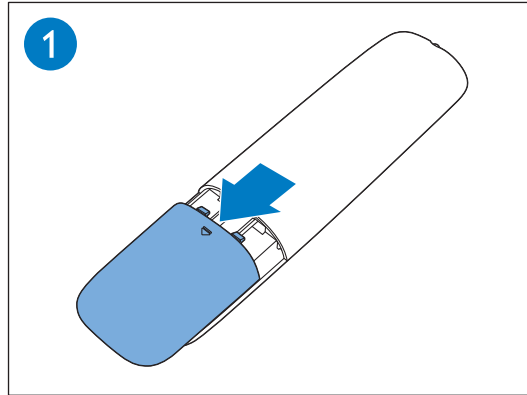





English

To wall mount, purchase a suitable bracket.

Bahasa Melayu

Beli pendakap yang sesuai jika ingin melekapkan ke dinding.



简体中文

如需壁挂,请购买合适的支架.

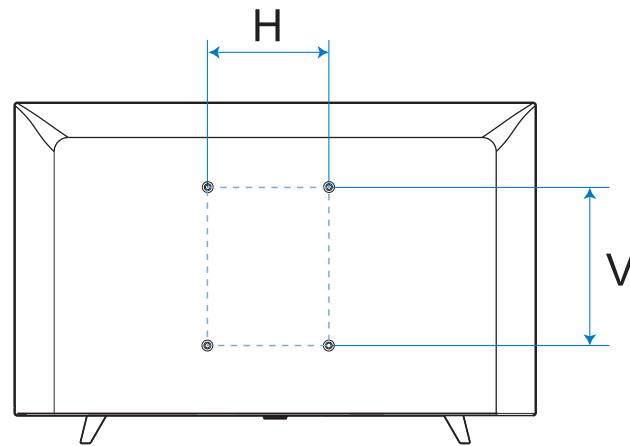
TV	H	V
108 cm / 43"	200 mm	300 mm
123 cm / 49"	200 mm	300 mm
139 cm / 55"	200 mm	300 mm



# 4

**English** Press the  key on the side panel of the TV or on the remote control to turn on the TV.  
**Bahasa Melayu** Tekan kekunci  di panel tepi TV atau pada alat kawalan jauh untuk menghidupkan TV.  
**简体中文** 按下电视机侧面面板或遥控器上的  打开电视。

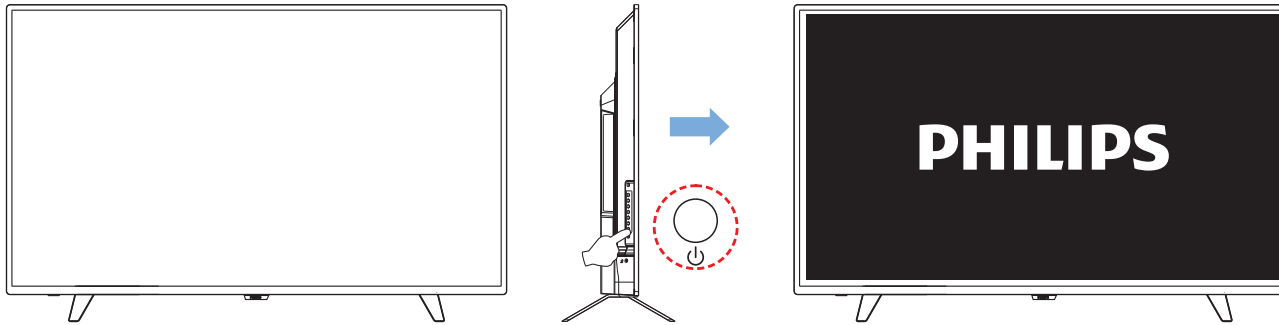



**English**

Please refer to the User's Manual and the Philips support website for more operating instructions.

**Bahasa Melayu**

Sila rujuk Panduan Pengguna dan tapak web sokongan Philips untuk arahan penggunaan selanjutnya

**简体中文**

更多操作信息请参考使用手册与PHILIPS support 网站。

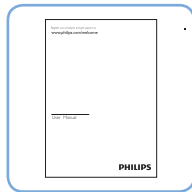



All registered and unregistered trademarks are the property of their respective owners. Specifications are subject to change without notice.

Philips and the Philips' shield emblem are registered trademarks of Koninklijke Philips Electronics N.V. and are used under license from Koninklijke Philips Electronics N.V.

2014© TP Vision Netherlands B.V. All rights reserved.

