

折后封面示意图，具体内容以设计为准



设计单单号：F1906039

设计稿、样稿确认

(相同样稿以最新承认日期为准)

物料编号：_____

物料描述：32F PHILIPS 俄文+英文 快速安装指南

(M2C1主板 欧洲 3663方案) (5000系列, 2019风格)

(风琴折, 总尺寸420x285mm, 折后尺寸420x95mm)

设计申请人：_____ 设计人：_____

承认人：_____ 承认日期：_____

备注：四色印刷, 整本为70g双胶纸

32F(32PHS5034/60) 带 BCCS-43

说: 遥控器 : 760132E2320744FLP1

侧贴膜 : 73722400D122200211

下贴膜 : 73722400D112221211

PHILIPS

Серия 5000

5000 series

Краткое руководство пользователя Quick Start Guide

裁切线, 不印刷

此处红色不印刷, 仅标注料号的二维码位置

料号请根据实际料号印刷
料号字体: Arial, 6 pt

731432000F018FLP11

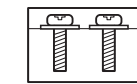
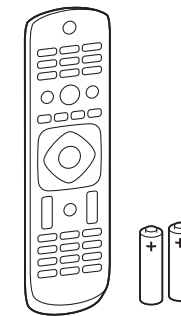
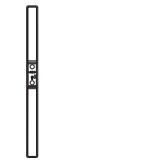
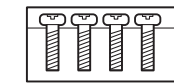

M4x10
винт самонарезающий
flat tail self-tapping screw

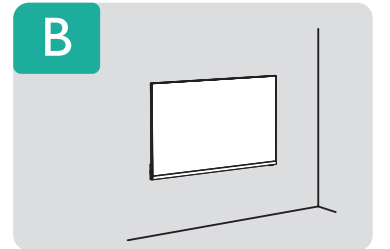

A

1

2

B

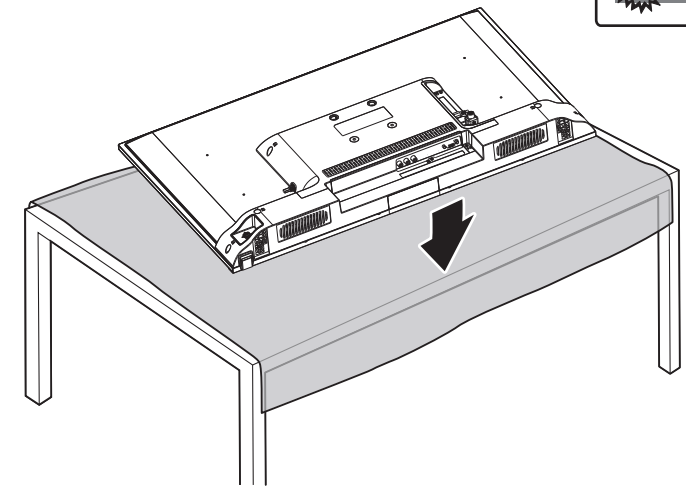
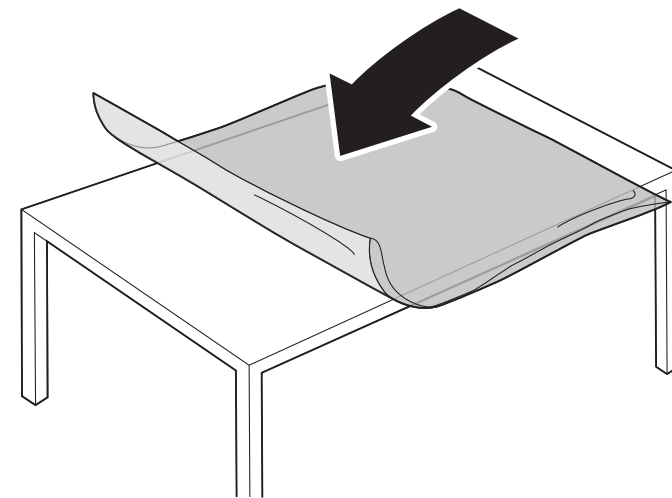
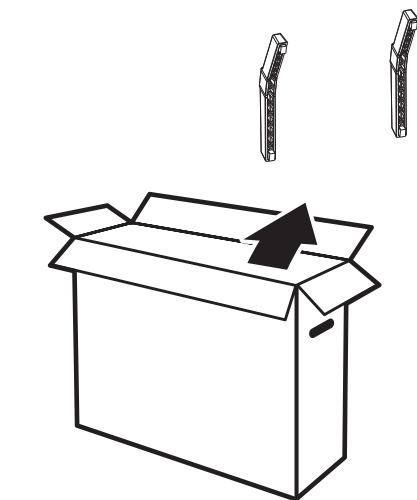

20 cm

VESA (x, y)

32" 75x75mm

80 cm



3

4

5

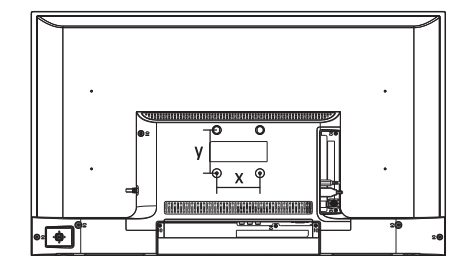
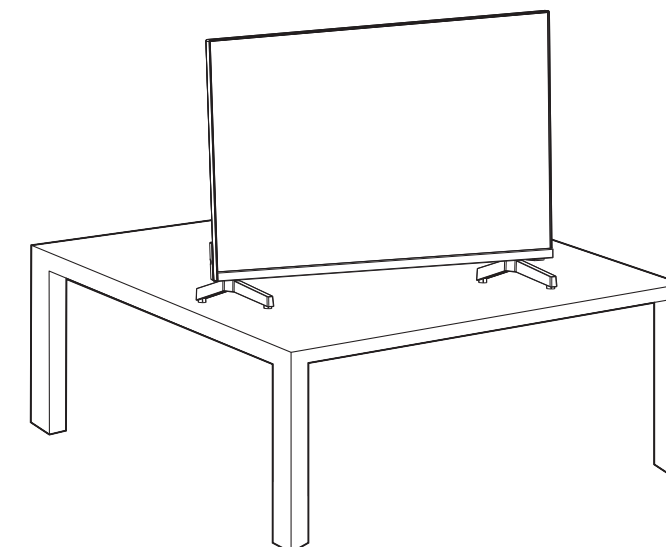
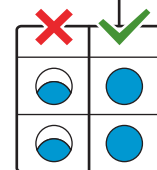
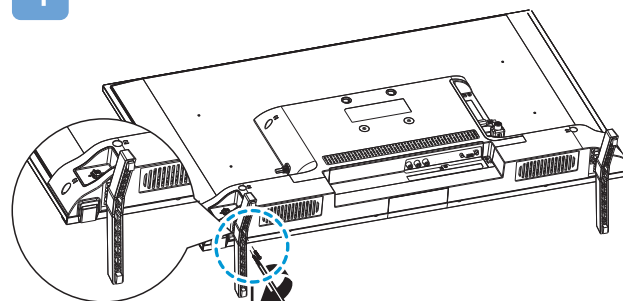
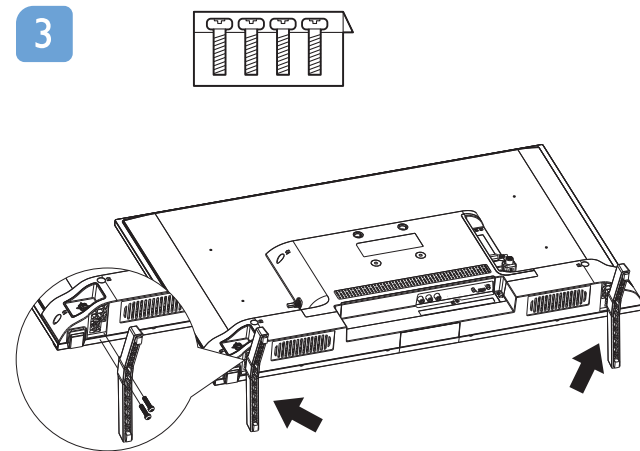

Необходимые установочные винты (рекомендуемая длина винта)
Required mounting screws (Recommended screw length)

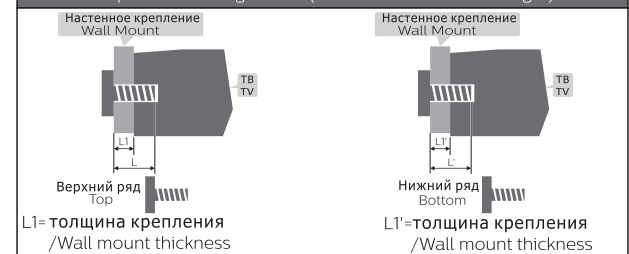

32" Верхний ряд: 2xM4 (L=8+L1) мм
Нижний ряд: 2xM4 (L'=8+L1') мм (самонарезающие винты)
32": Top: 2xM4 (L=8+L1) mm (machine screw)
Bottom: 2xM4 (L'=8+L1') mm (flat tail self-tapping screw)



English Read the safety instructions.
Bahasa Malaysia Baca arahan keselamatan.
Bahasa Indonesia Baca petunjuk keselamatan.
ภาษาไทย โปรดอ่านคำแนะนำด้านความปลอดภัย
Tiếng Việt Hãy đọc chỉ dẫn an toàn.
Português Brasileiro Por favor leia as instruções de segurança.
Português Leia as instruções de segurança.
Deutsch Lesen Sie die Sicherheitshinweise.
Français Lisez les consignes de sécurité.

简体中文 请阅读安全说明。
العربية قراءة تعليمات السلامة
Русский Ознакомьтесь с инструкцией по технике безопасности

Зарегистрируйте свой продукт и получите поддержку по адресу

Register your product and get support at www.philips.com/TVsupport

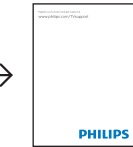
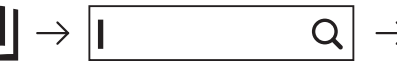

1

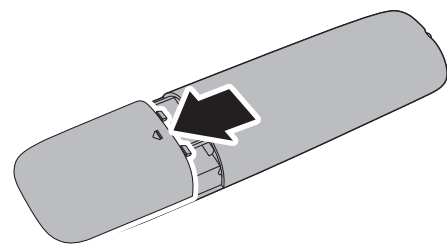

2

2x
AAA
1.5V

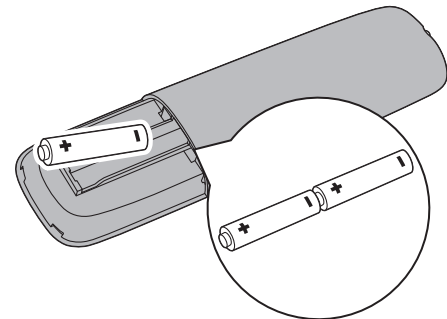

3

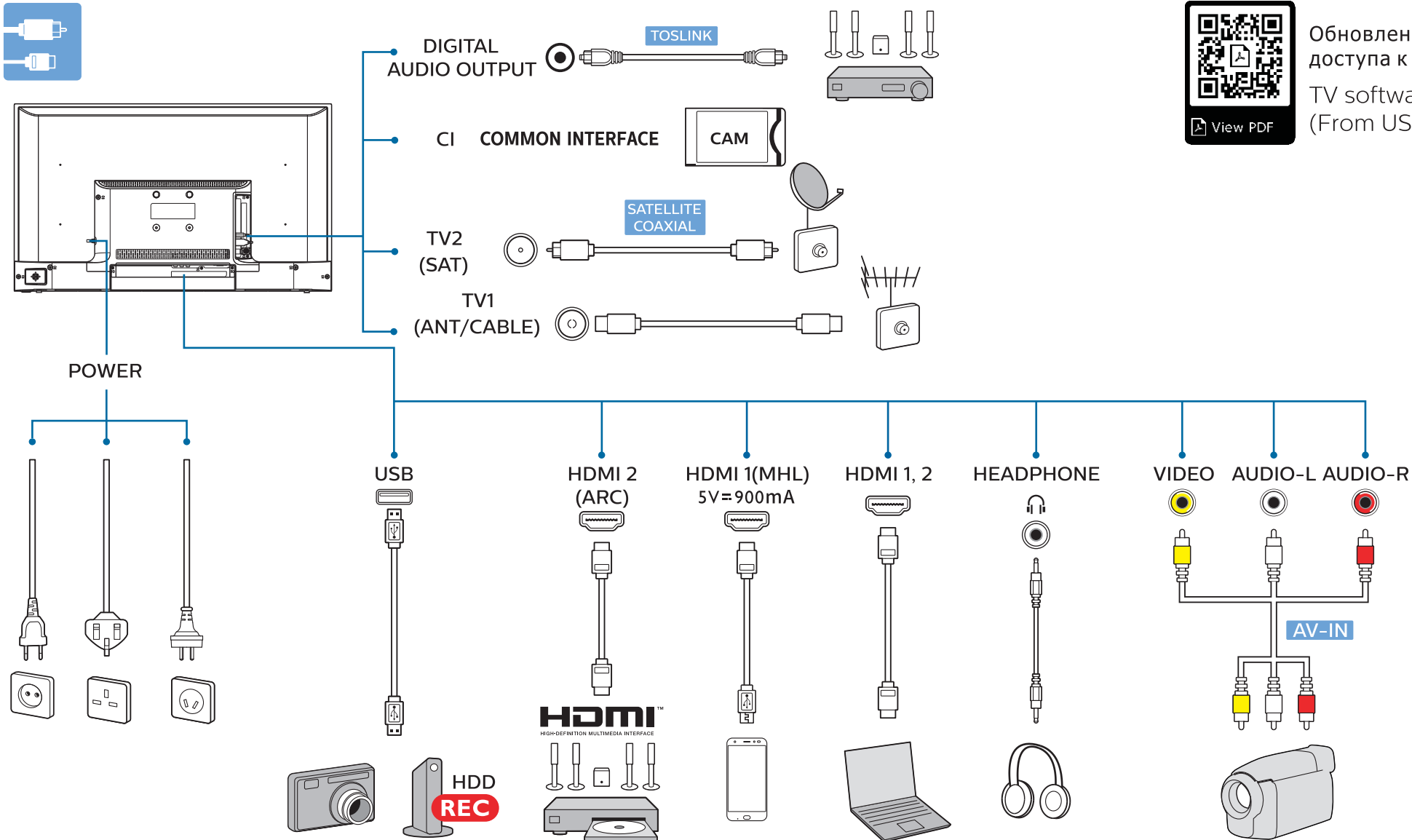
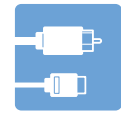
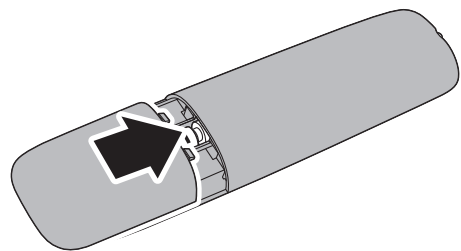

Обновление ПО для телевизора без доступа к Smart TV (через USB)
 TV software upgrade for Non-Smart TV (From USB)

