

Register your product and get support at
www.philips.com/welcome

42PFL7403S/60



EN LCD television

FR Téléviseur LCD

DE LCD-Fernsehgerät

РУС ЖК-ТВ



PHILIPS

Table of contents

1 Important 3

- 1.1 Safety 3
 - 1.2 Care of the screen 3
 - 1.3 Recycling 3
-

2 Your TV 4

- 2.1 Television overview 4
 - 2.2 Product highlights 5
-

3 Getting started 5

- 3.1 Position the TV 5
 - 3.2 Wall mounting - VESA 6
 - 3.3 Remote control batteries 7
 - 3.4 Antenna cable 7
 - 3.5 Power cable 7
-

4 Use your TV 8

- 4.1 Switch on or off - Standby 8
 - 4.2 Watch TV 8
 - 4.3 Watch channels from a digital receiver 9
 - 4.4 Watch connected devices 9
 - 4.5 Watch a DVD 9
 - 4.6 Select a Teletext page 9
-

5 Use more of your TV 10

- 5.1 Remote Control 10
 - 5.2 TV menus 11
 - 5.3 Picture and sound settings 12
 - 5.4 Teletext 15
 - 5.5 Create favourite channel lists 17
 - 5.6 Electronic Programme Guide 18
 - 5.7 Timers and locks 19
 - 5.8 Subtitles 20
 - 5.9 Watch and play photos and music 20
 - 5.10 Listen to digital radio channels 22
 - 5.11 Software update 22
-

6 Channel installation 25

- 6.1 Automatic channel installation 25
 - 6.2 Manual channel installation 27
 - 6.3 Rearrange stored channels 27
 - 6.4 Channel management 28
 - 6.5 Digital reception test 28
 - 6.6 Factory settings 28
-

7 Connections (DVD, receiver, ...) 29

- 7.1 Connections overview 29
 - 7.2 About connections 30
 - 7.3 Connect your devices with the Connection assistant 31
 - 7.4 Connect your devices without the Connection assistant 31
 - 7.5 Connection setup 37
 - 7.6 Preparing for digital services 38
-

8 Technical data 39

9 Troubleshooting 40

10 Index 42

Register your product and get support at www.philips.com/welcome.

2008 © Koninklijke Philips Electronics N.V. All rights reserved. Specifications are subject to change without notice. Trademarks are the property of Koninklijke Philips Electronics N.V. or their respective owners.

Philips reserves the right to change products at any time without being obliged to adjust earlier supplies accordingly. The material in this manual is believed adequate for the intended use of the system. If the product, or its individual modules or procedures, are used for purposes other than those specified herein, confirmation of their validity and suitability must be obtained. Philips warrants that the material itself does not infringe any United States patents. No further warranty is expressed or implied.

Warranty

No components are user-serviceable. Do not open or remove covers and do not insert objects in the ventilation slots or insert objects not suitable for the specific connectors. Repairs may only be done by Philips Service Centres and official repairshops. Failure to do so shall void any warranty, stated or implied. Any operation expressly prohibited in this manual, any adjustments, or assembly procedures not recommended or authorised in this manual shall void the warranty.

Pixel characteristics

This LCD product has a high number of colour pixels. Although it has effective pixels of 99,999% or more, black dots or bright points of light (red, green or blue) may appear constantly on the screen. This is a structural property of the display (within common industry standards) and is not a malfunction.

Open source software

This television contains open source software. Philips hereby offers to deliver or make available, upon request, for a charge no more than the cost of physically performing source distribution, a complete machine-readable copy of the corresponding source code on a medium customarily used for software interchange. This offer is valid for a period of 3

years after the date of purchase of this product.

To obtain the source code, write to Philips Innovative Applications N.V. Ass. to the Development Manager Pathoekeweg 11 B-8000 Brugge Belgium

Compliance with EMF

Koninklijke Philips Electronics N.V. manufactures and sells many products targeted at consumers, which, like any electronic apparatus, in general have the ability to emit and receive electromagnetic signals. One of Philips' leading Business Principles is to take all necessary health and safety measures for our products, to comply with all applicable legal requirements and to stay well within the EMF standards applicable at the time of producing the products. Philips is committed to develop, produce and market products that cause no adverse health effects. Philips confirms that if its products are handled properly for their intended use, they are safe to use according to scientific evidence available today. Philips plays an active role in the development of international EMF and safety standards, enabling Philips to anticipate further developments in standardisation for early integration in its products.

Copyrights



VESA, FDMI and the VESA Mounting Compliant logo are trademarks of the Video Electronics Standards Association.



Manufactured under license from Dolby Laboratories. 'Dolby', 'Pro Logic' and the double D symbol **DD**, are trademarks of Dolby Laboratories.



Manufactured under license from BBE Sound, Inc. Licensed by BBE, Inc under one or more of the following US patents: 5510752, 5736897. BBE and BBE symbol are registered trademarks of BBE Sound Inc.

Windows Media is either a registered trademark or trademark of Microsoft Corporation in the United States and/or other countries

® Kensington and MicroSaver are registered US trademarks of ACCO World Corporation with issued registrations and pending applications in other countries throughout the world.

All other registered and unregistered trademarks are the property of their respective owners.

1 Important

Read this user manual before you start to use this product.

Pay attention to this section and closely follow the instructions. The warranty does not apply to damage caused by not taking into account the instructions.

1.1 Safety

- To avoid short circuit, do not expose the product to rain or water.
- To avoid a risk of fire or electric shock do not place naked flame sources (e.g. lighted candles) close to the TV.
- Leave a space of at least 10cm (4 inches) all around the TV for ventilation.
- Keep away from radiators or other heat sources.
- Do not install the TV in a confined space such as a book case. Make sure that curtains, cupboards and so on cannot obstruct the air flow through the ventilation slots.
- To prevent damage, do not insert any object into the ventilation slots.
- Make sure the TV cannot fall down. Place the TV on a solid and flat surface and only use the stand provided with the TV.
- To prevent damaging the mains cord, do not place the TV, or anything else, on the cord. Damage the cord may cause a fire or electric shock.
- When mounted on a swivel stand or VESA wall bracket avoid force coming on the mains plugs. Mains plugs that are partly loosened can cause arcing or fire.

1.2 Care of the screen

- Unplug the TV before cleaning.
- Clean the surface with a soft damp cloth. Do not apply any other substance (chemical or household cleaning agent). This may damage the screen.
- Do not touch, push or rub or strike the screen with anything hard as this may scratch, mar or damage the screen permanently.
- To avoid deformations and colour fading, wipe off water drops as soon as possible.

- Stationary images
Avoid stationary images as much as possible. If you cannot, reduce screen contrast and brightness to prevent damage to the screen. Stationary images are images that remain on the screen for a long time. Examples of stationary images are: on screen menus, teletext pages, black bars, stock market information, TV channel logos, time displays, and so on.

1.3 Recycling

- Take the packaging to your local recycling centre.
- Dispose old batteries safely according local regulations.
- This product is designed and manufactured for material recycling and re-use.
- Do not dispose this product with other household waste. Inform yourself or ask your dealer about local environmentally safe recycling and local regulations. Uncontrolled waste disposal harms the environment and human health. (EEC 2002/96/EC)



2 Your TV

This section gives you an overview of the controls and functions of this TV.

2.1 Television overview

Controls

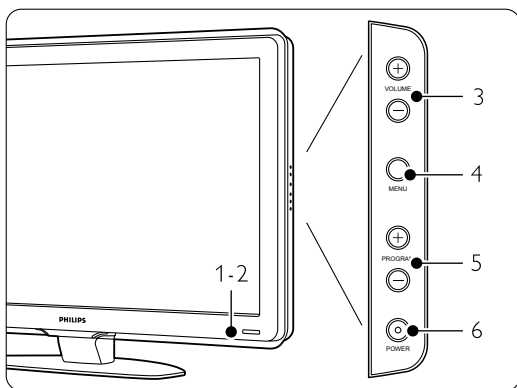

- 1 Indicator light
- 2 Remote control sensor
- 3 Volume up and down
- 4 Menu
- 5 Program/Channel up and down
- 6 Power switch

Connectors

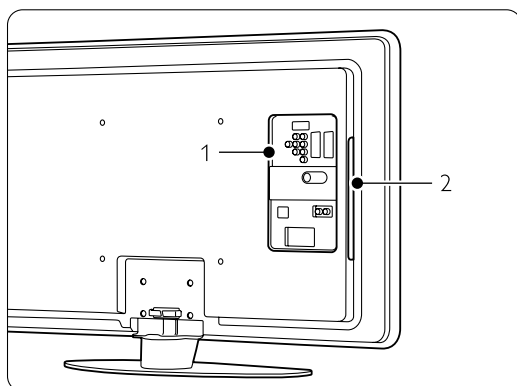

- 1 Back connectors
- 2 Side connectors

For more info see section 7 Connections.

Remote control

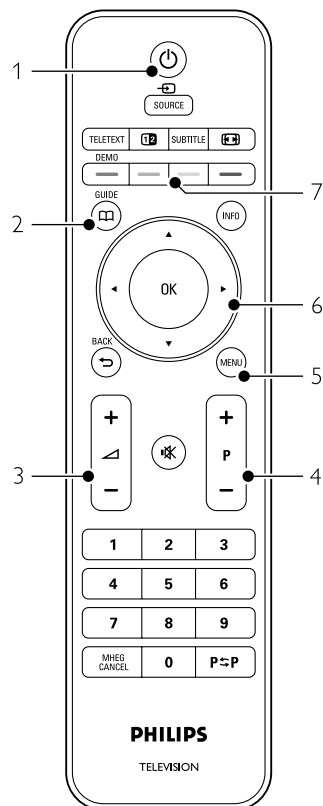

- 1 Switch On or switch to Standby
- 2 Programme guide
- 3 Volume up + or down -
- 4 Program/Channel up + and down -
- 5 Menu On or Off
- 6 Navigation key
- 7 Colour keys

For more info see section 5.1 Remote control overview.

2.2 Product highlights

Your new TV is equipped with some of the most modern audio or video innovations. Your TV offers the following advantages ...

Full High Definition LCD display

A full HD resolution of 1920x1080p, the highest resolution of HD sources. It offers a brilliant flicker-free progressive scan picture with optimum brightness and superb colours.

Pixel Plus

Offers perfect picture quality from any source.

100Hz Clear LCD

100Hz Clear LCD gives a superior motion sharpness, better black level, high contrast with a flicker-free, quiet image and a larger viewing angle.

DVB-T integrated tuner

Next to normal analogue TV broadcast your TV receives digital terrestrial TV and radio broadcasts.

Electronic Programme Guide - EPG

The EPG shows the scheduled digital TV programmes on screen. The guide can remind you when programmes start, switch the TV on, etc.

HDMI connectors

HDMI connectors for highest quality high definition connectivity.

USB connection

Multimedia connection for instantly view or play your photos or music.

3 Get started

This section helps you with the positioning and the first time installation of the TV.

3.1 Position the TV

Carefully read the safety precautions in section 1.1 Safety before you position the TV.

- Large screen TVs are heavy. Carry and handle the TV with at least two persons.
- The ideal distance from which to watch TV is three times its diagonal screen size.
- Position the TV where light does not fall directly on the screen.
- Your TV is equipped with a Kensington Security Slot at the back of the TV for an anti-theft lock (not supplied).

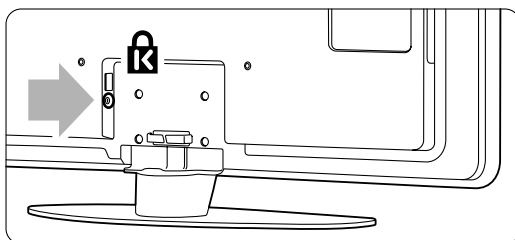

3.2 Wall mounting - VESA

⚠ Caution

Consider the TV's weight when you wall mount it. Improper mounting can result in severe injury or damage. Koninklijke Philips Electronics N.V. bears no responsibility for improper mounting or mounting that results in accident or injury.

Your TV is prepared for VESA compliant wall mounting. This bracket is not included. You need one of the VESA codes hereunder to purchase the bracket that fits your TV.

42" / 107cm VESA MIS-F 400, 400, 8

Ask your dealer for more info on stands and wallmount brackets.

The VESA fixation points

Locate the four fixation points at the back of the TV.

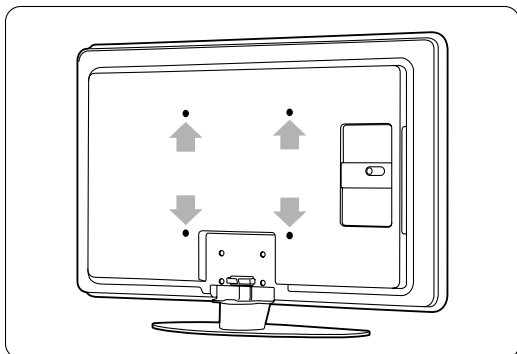

Unmount the TV stand

1 Locate the four screws of the TV stand.

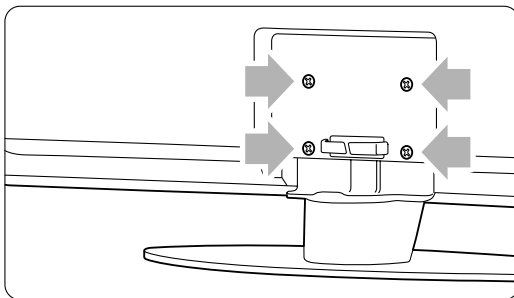

2 Unscrew the screws.

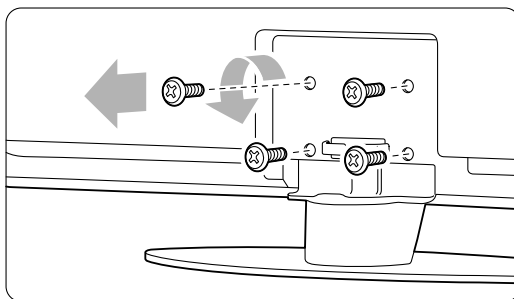

3 Lift the TV off the stand.

3.3 Remote control batteries

- 1** Open the battery cover on the back of the remote control.
- 2** Insert the 2 batteries supplied (Type AA-R6-1,5V). Make sure the + and - ends of the batteries line up correctly (inside of case is marked.)
- 3** Close the cover.

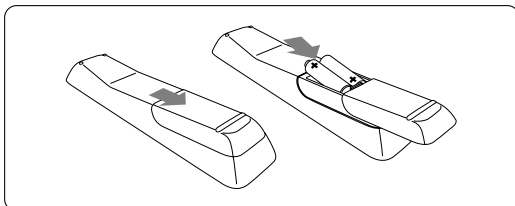

Note

Remove the batteries if not using the remote control for an extended period of time.

3.4 Antenna cable

- 1** Locate the antenna connection at the back of the TV.
- 2** Insert the antenna cable tightly into the Antenna socket.

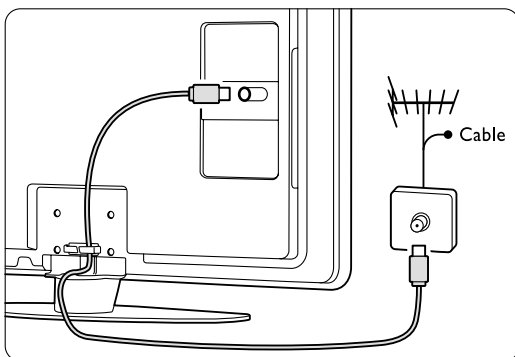

3.5 Power cable

Keep the mains plug at the wall socket accessible at all time.

The TV is never powered off completely and consumes energy unless the mains cord is physically unplugged.

Although this TV has a very low standby power consumption, unplug the mains cord if you do not use the TV for a long time to save energy.

- 1** Verify that your mains voltage corresponds with the voltage printed on the sticker at the back of the TV. Do not insert the mains cord if the voltage is different.
- 2** Insert the mains cord tightly.

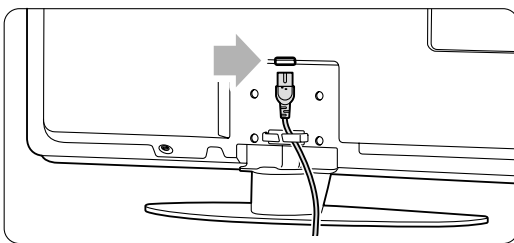

4 Use your TV

Learn how to operate your TV for daily use.

4.1 Turn on or off - Standby

Note

The TV may take up to 15 seconds to turn on.

To turn on the TV:

- Press **Power** at the right of the TV if the standby indicator is off.
- Press **Power** on the remote control if the standby indicator is on.

To switch to standby:

- Press **Power** on the remote control.

To turn off:

- Press **Power** at the side of the TV.

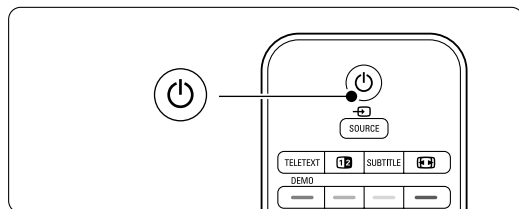
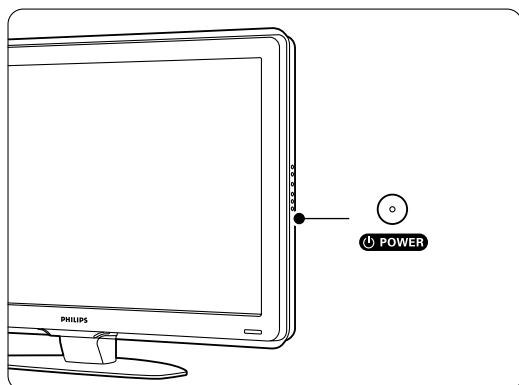

4.2 Watch TV

4.2.1 Switch channels

1 To switch TV channels:

- Press a number (1 to 999) or press **P+** or **P-** on your remote control.
- Press **Program/Channel -** or **+** on the side controls of the TV.

2 Press **P↔P** to return to the previously viewed TV channel or connected device.

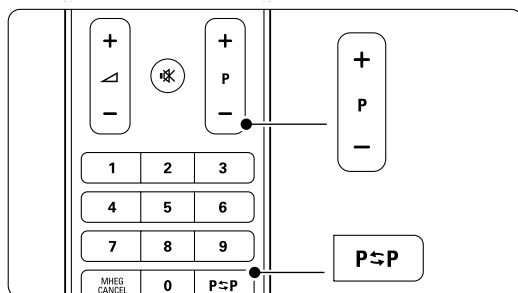

4.2.2 Adjust volume

1 To adjust the volume:

- Press **+ or -** on the remote control
- Press **Volume + or -** on the side controls of your TV.

2 To mute the sound:

- Press **Mute** on the remote control.
- Press **Mute** again to restore the sound.

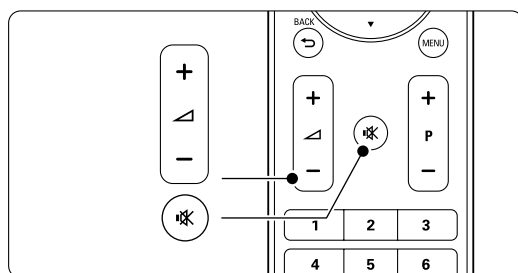

4.3 Watch channels from a digital receiver

- 1 Switch on the digital receiver.
The picture from your receiver automatically appears on the screen.
- 2 Use the remote control of your digital receiver to select TV channels.

If the picture does not appear:

- 1 Press the **Source**  key.
- 2 Press **▲** or **▼** to select where you connected your digital receiver.
- 3 Press **OK**.

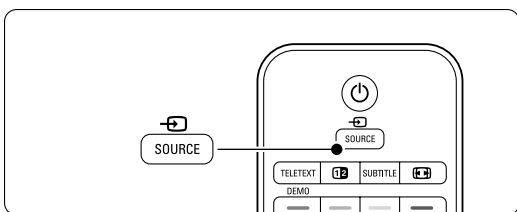

Note

When you did not connect your devices yet, go to section **7 Connections**.

4.4 Watch connected devices

- 1 Switch on the device.
The picture from your device automatically appears on the screen.

If the picture does not appear:

- 2 Press the **Source**  key.
- 3 Press **▲** or **▼** to select where you connected your device.
- 4 Press **OK**.



Note

When you did not connect your devices yet, go to section **7 Connections**.

4.5 Watch a DVD

- 1 Switch on your DVD player.
- 2 Insert a DVD disc in your player.
The DVD picture automatically appears on the screen.
- 3 Press **Play**  on the DVD player.

If the picture does not appear:

- 1 Press the **Source**  key.
- 2 Press **▲** or **▼** to select where you connected your DVD player.
- 3 Press **OK**.
Wait a few seconds until the picture appears.
- 4 Press **Play** .

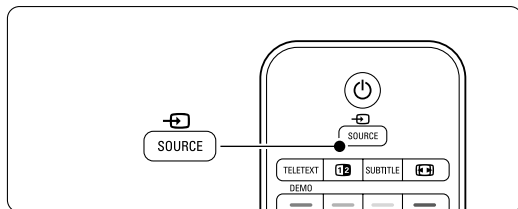

4.6 Select a Teletext page

Most TV channels broadcast information through Teletext.

To watch Teletext:

- 1 Press **Teletext**.
- 2 To select a page of your choice:
 - Enter the page number with the number keys.
 - Press **P-** or **P+** or **▲** or **▼** or the  key to view the next or the previous page.
 - Press a colour key to select one of the colour coded items at the bottom of the screen.
 - Press **P=P** to return to the previously viewed page.
- 3 Press **Teletext** again to switch Teletext off.

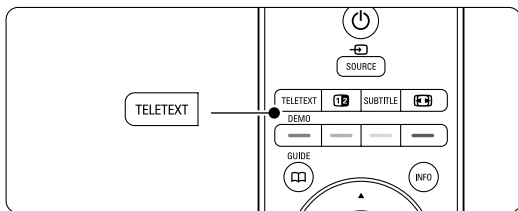

For more information on teletext, see section **5.4 Teletext**.

5 Use more of your TV

This section helps you perform advanced TV operations including how to:

- use the menus
- adjust picture and sound settings
- make use of Teletext
- create favourite channel lists



- make advantage of Electronic Programme Guide
- set locks and timers
- set subtitles and select a subtitle language
- view your photos or play your favourite music from a USB memory device or from your PC.

5.1 Remote control

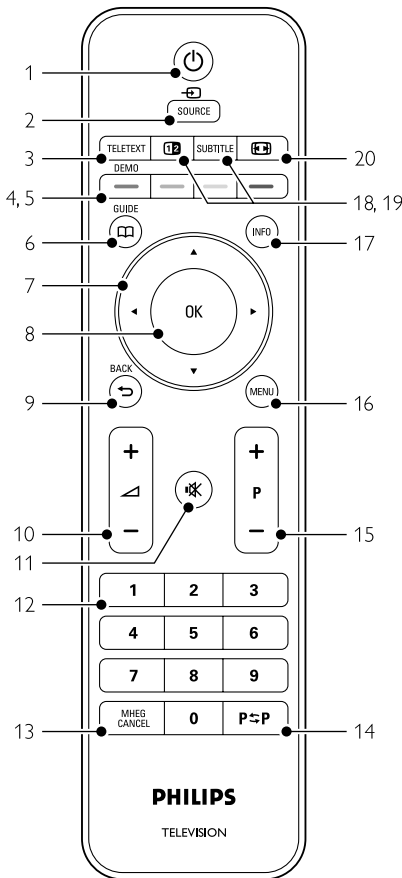
5.1.1 Remote control overview



- 1 Standby** To switch the TV on or back to standby.
- 2 Source**
 - To switch the Source menu on or off.
 - To select a connected device or to return to TV.
- 3 Teletext** To switch teletext on or off.
- 4 Colour keys**
 - Easy selection of teletext pages.
 - Easy selection of tasks.
- 5 Demo** To switch the Demo menu on and to get a demonstration of the features of the TV.
- 6 Guide** To switch on or off the Electronic Programme Guide.
- 7 Navigation key** To navigate (▲, ▼, ◀, ▶) or turn left or right to go through lists or settings.
- 8 OK**
 - To display the channel list.
 - To activate a setting.
- 9 Back key** To select the previous programme or the previous TXT page.
To remove the channel list.
- 10 Volume** To adjust the volume.
- 11 Mute** To mute the sound or restore it.
- 12 Number keys** To select a TV channel.
- 13 no function**
- 14 Previous channel** To return to the previously viewed channel

- 15 **+P- Channel up or down**
To switch to the next or previous channel in the channel list.
- 16 **Menu**
To switch the menu on or off
- 17 **On screen information INFO**
To show channel or programme information if available.
- 18 **Dual screen **
To show teletext on the right and the picture on the left of the screen.
- 19 **Subtitle**
To activate or deactivate the subtitle mode.
- 20 **Widescreen Picture format **
To select a picture format.

See section **10 Index** to find the section in the manual about a specific remote control key.

5.2 TV menus

With the on screen menus you install your TV, adjust picture and sound settings and access features. This section gives an overview of the menus and describes how to navigate.

5.2.1 The menu

1 Press **Menu** to show the TV menu.

2 Press **Menu** to quit the TV menu.

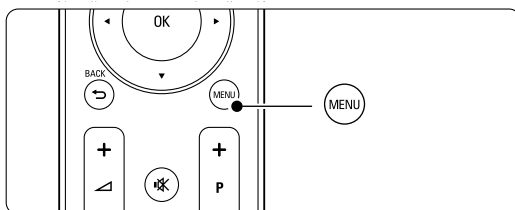

The **TV** menu offers the following items:

TV menu
Smart settings
Picture
Sound
Settings assistant
Features
Setup

- **Smart settings**
Select this item to set the TV to one of the predefined settings. Each setting combines picture and sound.
- **Picture**
Select this menu item to adjust all picture settings.
- **Sound**
Select this menu item to adjust all sound settings.
- **Settings assistant**
Use the Settings assistant to guide you through basic picture and sound settings in an easy way.
- **Features**
Select this item for other feature settings.
- **Setup**
Select this item
 - for installation and to update the TV software;
 - to use the connection assistant which will help you to connect your devices to the TV.

5.2.2 Use of the menu

Learn to use the menus with this example.

1 Press **Menu**.

The TV menu appears on the screen.

TV menu
Smart settings
Picture
Sound
Settings assistant
Features
Setup

2 Press **▲** or **▼** to select **Picture**.

3 Press **▶** to enter the picture settings.

Picture	Contrast
Contrast	90
Brightness	47
Colour	52
Hue	0
Sharpness	4
Noise reduction	
Tint	
...	

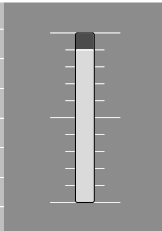

4 Press **▼** to select **Brightness**.

Picture	Brightness
Contrast	98
Brightness	47
Colour	52
Hue	0
Sharpness	4
Noise reduction	
Tint	
...	

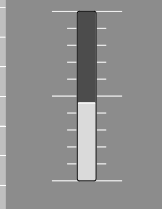

5 Press **▶** to enter the brightness setting.

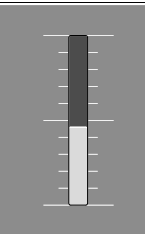
Brightness

6 Press **▲** or **▼** to adjust the setting.

7 Press **◀** to return to the Picture settings or press **Menu** to quit the TV menu.

Note:

More choices come available when digital channels are installed and broadcasted.

5.3 Picture and Sound settings

The first time you switched on the TV you have selected your preferred settings for picture and sound. The following sections describe how to modify or read just those settings.

5.3.1 Smart settings

Sets the TV to one of the predefined settings. Each setting combines picture and sound.

1 Press **Menu** and select **Smart settings**.

2 Press **▶** to enter the list.

3 Press **▲** or **▼** to select a setting.

4 Press **OK**.

5 Press **Menu** to quit the TV menu.

Smart settings: Personal, Vivid, Standard, Movie, Energy saving, Game.

5.3.2 Settings assistant

Use the Settings assistant to guide you through basic picture and sound settings in an easy way. Follow the instructions on screen.

1 Press **Menu**.

2 Select **Settings assistant** and press **▶** to enter.

3 Press the green key to start the assistant.

4 Press **◀** or **▶** to select the left or right side to make your choice.

5 Press the green key to go to the next setting. Go through several settings.

6 When finished, press the green key to store all your settings.

5.3.3 Picture settings

This section describes how to adjust all picture settings individually.

1 Press **Menu**.

2 Select **Picture** and press **▶** to enter the list.

3 Press **▲** or **▼** to select a setting.

• Contrast

Changes the level of bright parts in the picture but keeps the dark parts unchanged.

• Brightness

Changes the level of light of the total picture.

• Colour

Changes the level of saturation.

• Hue

If NTSC is broadcasted, this level compensates the colour variations.

TV menu	Picture
Smart settings	Contrast
Picture	Brightness
Sound	Colour
Settings assistant	Hue
Features	Sharpness
Setup	Noise reduction
	Tint
	Perfect Pixel HD
	Active control
	Light sensor
	Picture format
	Auto format mode

- **Sharpness**
Changes the level of sharpness of fine details.
- **Noise reduction**
Filters out and reduces the noise in the picture. Set the level to Minimum, Medium, Maximum or Off.
- **Tint**
Sets the colours to Normal, Warm (reddish) or Cool (bluish). Select Custom to make a setting of your own in the Custom menu.
 - **Custom**
Press the green key to select each bar to change the value of:
 - R-WP red whitepoint
 - G-WP green whitepoint
 - B-WP blue whitepoint
 - R-BL red blacklevel
 - G-BL green blacklevel
- **Pixel Plus**
Controls the advanced settings of the Pixel Plus Engine, resulting in best sharpness, contrast, colour and motion.

Picture	Pixel Plus
...	HD Natural Motion
Noise reduction	100 Hz Clear LCD
Tint	Advanced sharpn...
Pixel Plus	Dynamic contrast
Active control	Dynamic backlight
Light sensor	MPEG artefact red...
Picture format	Colour enhance...
Auto format mode	

- **HD Natural Motion**
Removes motion judder and reproduces smooth movement especially in movies.
- **100 Hz Clear LCD**
Gives a superior motion sharpness, better black level, high contrast with a flicker-free, quiet image and a larger viewing angle.



- **Advanced sharpness**
Enables superior sharpness, especially on lines and contours in the picture.
- **Dynamic contrast**
Sets the level at which the TV automatically enhances the details in dark, middle and light areas of the picture.
- **Dynamic backlight**
Sets the level at which power consumption can be reduced by dimming the brightness intensity of the screen.
Choose for the best power consumption or for the picture with the best brightness intensity.
- **MPEG artefact reduction**
Smooths the digital transitions in the picture.
- **Colour enhancement**
Makes the colours more vivid and improves the resolution of details in bright colours
- **Active control**
Corrects all incoming signals in order to provide the best picture possible.
Switches Active control on or off.
- **Light sensor**
Adjusts the picture settings on the lighting conditions of the room.
Switches Light sensor on or off.
- **Picture format / Auto format mode**
See section 5.3.4 Widescreen picture format.

5.3.4 Widescreen picture format

Avoid black bars on the sides or on top and bottom of the picture. Change the picture format to a format that fills the screen.

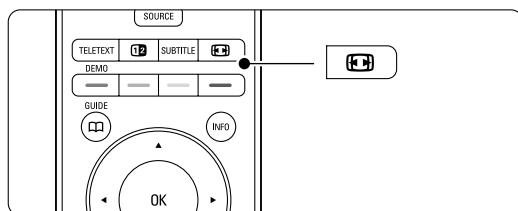
- 1 Press  to switch on the Picture format menu.



- 2 Press  or  to select an available picture format.
- 3 Press **OK**.
- 4 Press  to shift the picture upwards if subtitles are hidden.

Tip

For minimal distortion, select the Auto format setting.

- **Auto format** (Not for PC.)
Enlarges the picture automatically to fill the screen. Subtitles remain visible. You can set Auto format in two different modes.

1 In the TV menu, select **Picture > Auto format mode**.

2 Select **Auto-fill** to fill the screen as much as possible. Select **Auto-zoom** to keep the original picture format but black bars may be visible.

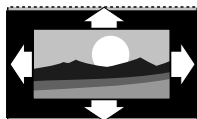

- **Super zoom** (Not for HD.)
Removes the black bars on the side of 4:3 broadcasts. There is a minimal distortion.

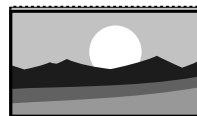

- **4:3** (Not for HD.)
Shows the classical 4:3 format.

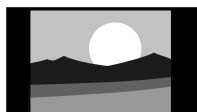

- **Movie expand 14:9** (Not for HD.)
Scales the format to 14:9.



- **Movie expand 16:9** (Not for HD.)
Scales the format to 16:9.

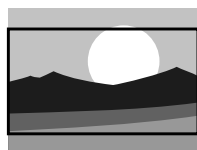

- **Wide screen**
Stretches the format to 16:9.

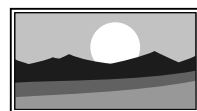

- **Unscaled** (Only for HD and PC.)
Maximum sharpness. Distortion may appear on borders. Black bars may appear with pictures from your PC.

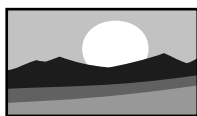

Note

Do not forget to name the connection in the Connection menu. See section 7.5.1 Naming your devices.

5.3.5 Sound settings

This section describes how to adjust all sound settings.

- 1** Press **Menu** and select **Sound**.
- 2** Press **▶** to enter the list.
- 3** Press **▲** or **▼** to select a setting.

TV menu	Sound
Smart settings	Equalizer
Picture	Volume
Sound	Balance
Settings assistant	Audio language
Features	Dual I/II
Setup	Mono/Stereo
	TV speakers
	Surround mode
	Headphone volume
	Auto volume level...
	Delta volume
	Auto surround

- **Equalizer**
Changes the bass and treble of the sound. Select each bar to change the setting.
- **Volume**
Changes the volume. When adjusting the volume with a volume bar appears. If you do not want it to appear go to Menu > Setup > Installation > Preferences and press **▶** to enter the list and select Volume bar off.
- **Balance**
Sets the balance of the left and right loudspeakers to fit best your listening position.
- **Audio language**
A list of audio languages for the current programme may be available when digital channels are installed and broadcasted. To permanently change the audio language, see section 6 Channel installation.
- **Dual I/II**
If broadcasted, you can choose between two different languages.
- **Mono/stereo**
If stereo broadcasting is available, you can select Mono or Stereo per TV channel.
- **TV speakers**
If you have connected an audio system to your TV, you can switch off the TV speakers. This option is only available if EasyLink is set to On. See Menu > Setup > Installation > Preferences > EasyLink. Select **Automatic (EasyLink)** to have the sound from your TV automatically reproduced by your audio system.

- **Surround mode**

To select a more spatial sound if broadcasted or if available from a connected device.

- **Headphone volume**

Changes the volume of the headphone.

You can mute the TV speakers with  on the remote control.

- **Auto volume levelling**

Reduces sudden volume differences like at the beginning of commercials or when switching from one channel to another.

Select on or off.

- **Delta volume**

Levels out volume differences between channels or connected devices.

1 Switch to the channel or device you want to level out the volume difference.

2 Select **Delta volume** in the Sound menu and change the volume level.

- **Auto surround**

Switches the TV automatically to the best surround sound mode dependant on the broadcast.

Select on or off.

5.4 Teletext

Your TV has a 1200 pages memory that stores broadcasted teletext pages and subpages to reduce waiting time.

To select a teletext page see section **4.6 Select a Teletext page**.

5.4.1 Select a teletext language

Some digital TV broadcasters offer the possibility to select your preferred teletext language. See section **6.1 Automatic installation**.

5.4.2 Select pagenumber subpages

A teletext page number can hold several subpages. The pages are shown on a bar next to the main pagenumber.

1 Press **Teletext**.

2 Select a teletext page.

3 Press **◀** or **▶** to select a subpage.

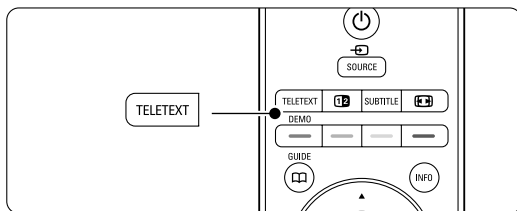

5.4.3 Select T.O.P. teletext broadcasts

T.O.P. teletext (Table of Pages) is not broadcast by all TV channels. You can easily jump from one subject to another without using pagenumbers.

1 Press **Teletext**.

2 Press **Info**.

The T.O.P. overview appears.

3 Use **◀** or **▶**, **▲** or **▼** to select a subject.

4 Press **OK** to view the page.

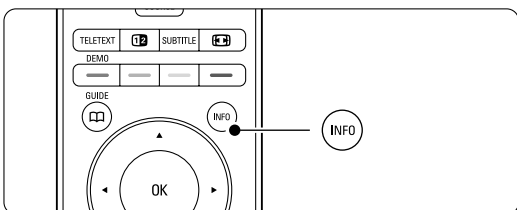

5.4.4 Dual screen teletext (not available for channels with Digital Text services)

View the TV channel and teletext next to each other.

- 1 Press **12** for Dual screen teletext.
- 2 Press **Teletext** again to show normal teletext.
- 3 Press **Teletext** to switch off teletext.

5.4.5 Search teletext pages

Quickly jump to a subject linked to a series of pagenumbers or search for specific words in teletext pages.

- 1 Press **Teletext**.
- 2 Press **OK** to highlight the first word or number.
- 3 Press **◀** or **▶**, **▲** or **▼** to jump to the next word or number on the page.
- 4 Press **OK** to search a page which holds the highlighted word or number.
- 5 Press **▲** until no word or number is highlighted to quit Search.

5.4.6 Enlarge teletext pages

For a more comfortable reading, you can enlarge the teletext page.

- 1 Press **Teletext** and select a teletext page.
- 2 Press **⏏** to enlarge the top part of the page.
- 3 Press **⏏** again to view the enlarged lower part of the page.
- 4 Press **▲** or **▼** to scroll through the enlarged page.
- 5 Press **⏏** again to return to the normal page size.

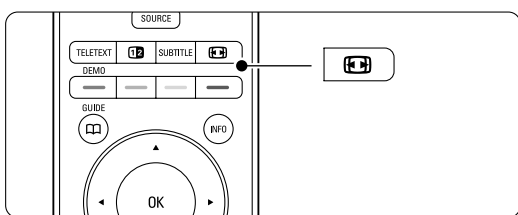

5.4.7 Teletext menu

With the options in the teletext menu you can reveal hidden info, let cycle subpages automatically and change the character setting.

- **Reveal**
Hide or unhide hidden information on a page, such as solutions to riddles or puzzles.
- **Cycle subpages**
If subpages are available for the selected page, you can make subpages cycle automatically.

- **Language**
Some languages use a different set of characters. Switch to the other group to show the text correctly.
- 1 Press **Teletext**.
 - 2 Press **Menu**.
 - 3 Press **▲** or **▼** to select an option.
 - 4 Press **OK** to change a setting.
 - 5 Press **Menu** to quit the teletext menu.
 - 6 Press **Teletext** to switch off teletext.

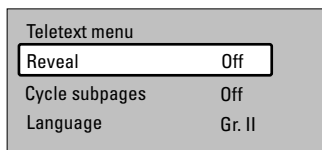

5.4.8 Teletext 2.5

If broadcasted by the TV channel this teletext offers more colours and better graphics.

Teletext 2.5 is switched on as a factory setting.

- 1 Press **Menu** on the remote control and select **Setup > Installation > Preferences > Teletext 2.5** and press **▶** to enter the list.
- 2 Select on or off.

5.5 Create favourite channel lists

View the All channels list or set up a Favourite list of your own with your preferred TV channels and radio stations.

5.5.1 Select a favourite list

You can select one of the favourite channel lists.

- 1 Press **OK**.

The first time after you have finished the installation, the All channels list is shown. In other situations, it brings up the last selected favourite list.

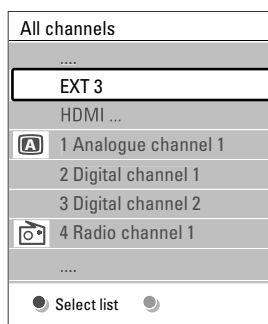

- 2 Press the red key to show all favourite lists.
- 3 Press **▲** or **▼** to select a list.
- 4 Press **OK**.
The selected favourite list appears.
- 5 Press **OK** again to quit.

5.5.2 To set up a favourite list

Create or modify your own favourite list.

- 1 Press **OK**.
The last selected list appears.
- 2 Press the red key to show all favourite lists.
- 3 Press **▲** or **▼** to select a list.
- 4 Press **OK**.
- 5 Press the green key to enter the Edit mode.
The selected list brings up a full channel list.
- 6 Press **▲** or **▼** to highlight a channel.
- 7 Press **OK** to mark (or unmark) the highlighted channel. The channel is added to (or removed from) the selected list.
- 8 Press the green key again to leave the Edit mode.
The modified channel list appears again.

5.5.3 Select a channel from a favourite list

- 1 Press **OK**.
The last selected channel list appears.
- 2 Use **▲** or **▼** to highlight a channel.
- 3 Press **OK**.
The TV tunes to that channel.

Tip

- Use **-P+** to go through the TV channels of the selected favourite list.
- With the number keys you can still select channels which are not marked as favourite.

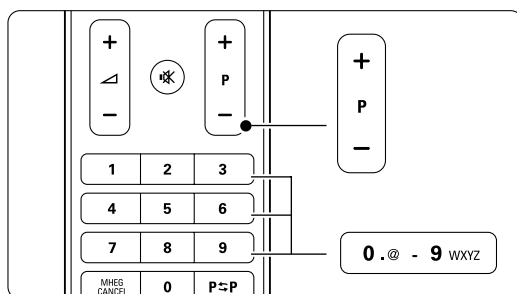

5.6 Electronic Programme Guide - EPG -

The Electronic Programme guide is an on screen guide to scheduled digital TV programmes. You can navigate, select and view programmes by time, title or genre. There are two types of EPG, 'Now and Next' and '7 or 8 day' EPG.

When digital channels are installed and broadcasted, EPG is available. 'Now and Next' is always available but the '7 or 8 day' EPG is only available in some countries.

With the EPG menu you can...

- see a list of current broadcasted programmes
- see the next programme
- group programmes by genre
- set reminders when programmes will start
- set up preferred EPG channels
- etc.

5.6.1 Switch on EPG

- 1 Press .

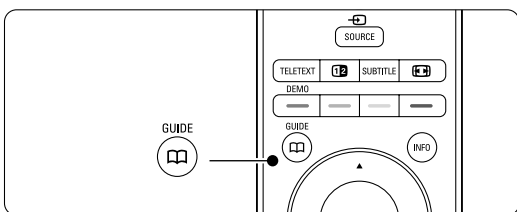

The following type of EPG appears:

'Now and Next' EPG

Detailed information about the current programme is shown.

26 BBC1	Tue., 12 Sep	09:17
Title : Commonwealth Games		
Info: 7:50 - 12:30 : 280 min		
Exit	Next	
Press -P+ to change channel.		

Or

'7 or 8 day' EPG

It may take some time to receive the EPG data. The list of TV programmes will show.

Programme guide				Tue., 12 Sep	
	Around	09:55	Next		
BBC ONE	07:50	Commonwealth	12:30	Commonwealth	
BBC TWO	09:50	Tweenies	10:15	Something Special	
five	09:00	The Wright Stuff	10:30	Trisha Goddard	
BBC THREE	05:32	This is BBC THREE	12:00	This is BBC THREE	
BBC FOUR	05:32	This is BBC FOUR	12:00	This is BBC FOUR	
abc1	09:20	Moonlighting	10:15	Daddio	
Remind 13:50 Anastasia Watch Jump to ... Info 0010 - EEN					

- 2 Use the colour keys to activate the available actions at the bottom of the screen.
 - **Next:** to show information about the next programme.
 - **Remind:** to mark or unmark a programme as a reminder.
 - **Watch:** to watch or listen to a current programme.
 - **Jump to...:** to jump to the next or previous day.
 - **Info:** to display information on a selected programme (if available).
- 3 Press  to quit the EPG.







5.6.2 More on '7 or 8 day' EPG

Search by genre, scheduled reminders, etc. are managed in the Programme guide menu.

- 1 Press  on the remote control.
- 2 Press **Menu**.

The Programme guide menu appears.

Programme guide	What's on
What's on	12:30 South Today
Search by genre	11:50 Working Lunch
Scheduled remind...	11:55 Melrose Place
Preferred EPG ch...	13:00 In aller Freund
Acquire EPG data	

- 3 Press  or  to select a menu option.
- 4 Press  to enter.
- 5 Press  or  to make a selection.
- 6 Press **OK** to activate or press the green key to watch
- 7 Press  to quit the EPG.

Note

Only channels marked as Preferred EPG channels appear in the Programme guide menu.

5.7 Timers and locks

This section describes how to switch the TV on or off at a specified time and to lock or unlock the TV.

5.7.1 Automatically switch to standby

Sleeptimer switches the TV to standby after a time.

- 1 Press **Menu**.
- 2 Select **Features > Sleeptimer** and press **▶** to enter the sleeptimer bar.
- 3 Press **▲** or **▼** to set the time up to 180 minutes in steps of 5 minutes. If set to 0 minutes, the Sleeptimer is switched off.

You can always switch off your TV earlier or reset the time during countdown.

5.7.2 Automatically switch the TV on

On timer switches the TV on automatically to a specified channel at a specified time, from standby.

- 1 Press **Menu**.
- 2 Select **Features > On timer** and press **▶** to enter the On timer menu.
- 3 Use **◀** or **▶**, **▲** or **▼** to select and enter the menu items one by one to set a channel, a day of the week or daily, and a starting time.
- 4 Press **OK** to confirm.
- 5 Press **Menu** to quit the menu.

⊕ Tip

To switch off the On timer, select **Off** in the On timer menu.

5.7.3 Lock TV channels and programmes

Lock TV channels and/or programmes from connected devices to prevent children from watching them. Lock and unlock with a four number code.

Set or change your code

- 1 Press **Menu**.
- 2 Select **Features > Set or Change code** and press **▶** to enter your code.
- 3 Enter your code with the number keys.
The **Features** menu reappears with a message confirming that your code has been created or changed.

Did you forget your code ?

- 1 Select **Change code**.
- 2 Press **▶**.

- 3 Enter the overriding code 8-8-8-8.

- 4 Enter a new personal code.

- 5 Confirm your new entered code.

The previous code is erased and the new code is stored.

5.7.4 Activate or deactivate Child lock

Set your code and you can:

- Lock all channels and devices,
- Lock specific channels and devices,
- Set a time after which all channels and devices are locked,
- Set the maximum allowed parental rating for digital channels that are installed and broadcast.

- 1 Press **Menu**.
- 2 Select **Features > Child lock** and press **▶**.
- 3 Enter your code with the number keys.
- 4 Select one of the options.
- 5 Press **▶**.

Lock or unlock all channels and connected devices

- 1 Select **Lock** or **Unlock**.

Lock a certain programme or all channels from a certain time

Child lock	Custom lock
Lock	Lock after
Custom lock	Channel lock
Unlock	Parental rating

- 1 Select **Custom lock**.
- 2 Press **▶** to enter the Custom lock menu.
- 3 Press **▶** again to enter the Lock after menu.
- 4 Select **On** to switch on the Timer lock.
- 5 Press **◀**.
- 6 Select **Time**.
- 7 Press **▶**.
- 8 Enter the time with **▲** or **▼** and **▶**.
- 9 Press **OK**.

Lock one or more channels and connected devices

- 1 Select **Custom lock**.
- 2 Press **▶** to enter:
- 3 Press **▲** or **▼** to select **Channel lock**.
- 4 Press **▶**.
- 5 Press **▲** or **▼** to select the channel(s) you want to lock or unlock.
- 6 Each time press **OK** to lock or unlock the channel.

Set an age rating to a digital programme

Some digital broadcasters have their programmes rated (depending on your country). When the rating is higher than your child's age, the programme will be locked.

- 1 Select **Custom lock**.
- 2 Press **▶** to enter.
- 3 Press **▲** or **▼** to select **Parental rating**.
- 4 Press **▶**.
- 5 Press **▲** or **▼** to select an age rating.
- 6 Press **Menu** to quit the Child lock menu.

5.8 Subtitles

For each TV channel, subtitles can be set, coming from Teletext or DVB-T (digital) broadcasts. If digital channels are installed and broadcasted, you can select your preferred subtitle language.

5.8.1 Subtitling from analogue TV channels

- 1 Select an analogue TV channel.
- 2 Press **Teletext** to switch on Teletext.
- 3 Enter the three number pagenummer of the subtitle page.
- 4 Press **Teletext** to switch off Teletext.

Note

The Teletext subtitle page of analogue channels must be stored for each TV channel separately.

5.8.2 Activate or deactivate subtitling

- 1 Press **Menu**.
- 2 Select **Features** > **Subtitle** and press **▶** to enter the list.
- 3 Press **▲** or **▼** to select **On** to show the subtitles always or **On during mute** to show the subtitles only when the sound is muted with the  key on the remote control.
- 4 Press **◀** to return to the Features menu.

TV menu	Features
Smart settings	Common interface
Picture	Subtitle
Sound	Subtitle language
Settings assistant	Sleeptimer
Features	Child lock
Setup	Set/Change code
	On timer
	Demo

5.8.3 Select a digital subtitle language

If subtitle broadcasting is available with digital channels, you can select a preferred subtitle language out of a list of broadcasted languages. The preferred subtitle languages set in the Installation menu are overruled temporarily.

- 1 Press **Menu**.
- 2 Select **Features** > **Subtitle language** and press **▶** to enter the list of available languages.
- 3 Press **▲** or **▼** to select a subtitle language.
- 4 Press **OK**.

5.9 Watch and play your photos and music

Watch pictures or listen to music stored on a USB device (not supplied with the TV) or a camcorder (only for photos). Watch your pictures as a slideshow or listen to a self made music playlist.

Note

Philips is not responsible if your USB device is not supported nor shall Philips accept any liability for damage or loss of stored data. See section 8 **Technical data** for the playback formats supported.

5.9.1 Insert the USB device

- 1 Insert a device at the side of the TV while the TV is switched on.
A message appears that a USB device has been detected.

Note

In case the USB device does not automatically break in, press **Source**  > **USB/Memory devices** and press **OK**.
Select **Side** and press **OK** to display your camcorder content.

5.9.2 Remove the USB device

- 1 Press **Source** .
- 2 Remove the USB device.
- 3 Select **TV** or another connected device to watch a programme.

5.9.3 Watch your pictures, start a slideshow and play music

Look up your pictures in the Picture album of your USB device.

- 1 Select the Picture folder for the picture files you have stored on your USB device.

USB	Picture
Picture	Afrika_2001
Music	Paris_2006
	My_car.jpg
	Jean.jpg
	Mary.jpg

- 2 Press **▶** to enter the Picture folder.
- 3 Press **▲** or **▼** to select a picture or a picture album.

Picture	Afrika_2001
Afrika_2001	Kenya.jpg
Paris_2005	Congo.jpg
My_car.jpg	Victoria.jpg
Jean.jpg	Dakar.jpg
Mary.jpg	Cairo.jpg

Afrika_2001	Afrika_2001
Kenya.jpg	
Congo.jpg	
Victoria.jpg	
Dakar.jpg	
Cairo.jpg	

- 4 Press **OK** to watch the picture or to start a slideshow of the pictures in the album.
- 5 Press **OK** to pause the slideshow. Press again to restart.
- 6 Press one of the colour keys on the remote control to perform the corresponding function shown at the bottom of the screen. If the function bar at the bottom disappeared, press any colour key to let it reappear.
- 7 Press **◀** and select another picture or another album.

Slideshow settings

- **Details / More details**

Shows the picture name, date, size and next picture in the slideshow.

- **Transitions**

Shows the list of available transition styles of the pictures.

Press **▲** or **▼** to select and press **OK** to activate.

- **Slide time**

Sets the time lag for the picture transitions: Short, Medium or Long.

- **Rotate**

To rotate a picture.







- **Start/Show/Pause**

To stop, pause and restart the slideshow.

Thumbnails

Watch the pictures of a selected album in an overview.

- 1 Select a picture album.
- 2 Press **▶** to enter the picture list.
- 3 Press the blue key.
- 4 Press **▲** or **▼**, **◀** or **▶** to highlight a picture.
- 5 Press **OK** to watch the picture.
- 6 Press **◀** to return to the thumbnail overview.
- 7 Press the blue key again to go back to the picture list.

USB	Afrika_2001	Kenya.jpg
		
		

Listen to music

Look up your songs in the Music album of your USB device.

- 1 Select the Music folder for the music files you have stored on your USB device.
- 2 Press **▶** to enter the Music folder.
- 3 Press **▲** or **▼** to select a song or a music album.
- 4 Press **OK** to play the selected song or to play a song followed by the next song in the same album.
- 5 Press one of the colour keys on the remote control to perform the corresponding function shown at the bottom of the screen. If the function bar at the bottom disappeared, press any colour key to let it reappear.

Music settings

- **Details**

Shows the file name.

- **Repeat one/all**

Repeat all songs in the album until you stop a song or only repeat the one song selected until you stop the song.

- **Shuffle**

Play songs in a random sequence.

Watch a slideshow with background music

Watch a slideshow of your stored pictures accompanied with your stored background music.

- 1 Select an album of songs first and press **OK**.
- 2 Highlight the Picture folder and select an album of pictures and press **OK**.

5.10 Listen to digital radio channels

If digital broadcasting is available, digital radio channels are installed during installation.

To listen to a digital radio channel:

- 1 Press **OK** on the remote control.
The **All channels** menu is displayed.
- 2 Use the number keys to select a radio channel available from channel number 400 onwards.
To reorder see section **6.3.3 Reorder the channels**.
- 3 Press **OK**.

5.11 Software update

Philips continually tries to improve its products. To benefit, update the TV software regularly. To update your TV software you need a USB Memory device (not supplied).

Verify that your USB memory device has at least 48Mb free space. Make sure the write protection is switched off. Some USB devices do not work with our TV.

See section **8 Technical data** for the USB formats supported.

5.11.1 Update assistant

The Update assistant helps you to update the TV's software.

Step 1: TV identification

The TV has to identify with your USB memory device.

- 1 Press **Menu > Setup**.
- 2 Press **▶**.
- 3 Press **▲** or **▼** to select **Software update**.
- 4 Press **▶**.

Setup	Software update
Installation	Update assistant
Software update	Current software ...
	Local updates
	Announcement

- 5 Press **▲** or **▼** to select **Update assistant**.
- 6 Press **▶**.
- 7 Press **OK** to activate.
- 8 Insert a USB memory device into the USB connector at the side of the TV.
The TV menu appears.
- 9 Press the green key to proceed.
A message appears that the TV has successfully written its identification file to the USB memory device.
- 10 Press the green key again to finish.
- 11 Remove the USB memory device from the TV.

Step 2: Software download from the PC to the USB device

- 1 Insert the USB memory device into a PC linked to the internet.
- 2 Locate and open the file **update.htm** on your USB device.
- 3 Read the instructions on screen and click on the **Send ID** button.
If new software is available, the update is downloaded on the USB memory device.
- 4 Remove the USB memory device from your PC.

Step 3: Software update transfer to the TV

The downloaded software on the USB memory device must now be uploaded to your TV.

! Caution

- Never remove the USB memory device from the TV during the software update.
- If a power drop occurs during the update, do not remove the USB memory device from the TV. When the power returns, the TV continues to update.

- 1 Switch on the TV.
- 2 Insert the USB memory device to the USB connector at the side of the TV.

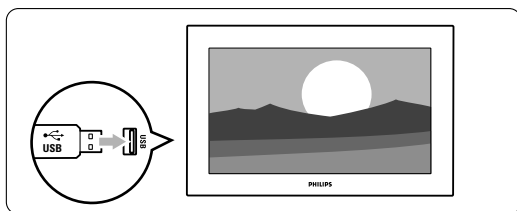

- 3 The TV switches off. The screen stays black for about 10 seconds. Wait and do not use the power switch  on the TV.

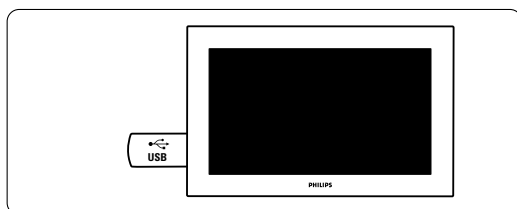

- 4 The update process starts automatically. Please wait.

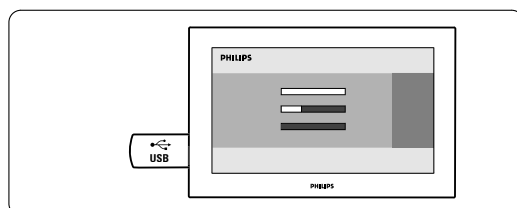

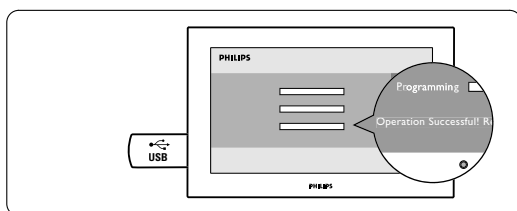

The update is finished when the message 'Operation successful' appears on the screen.

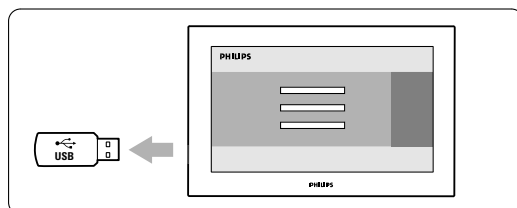

- 5 Remove the USB memory device from the TV.



- 6 Press  on the remote control. Do not press more than once and do not use the **Power**  switch on the TV.

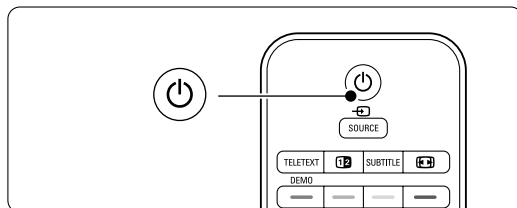

- 7 The TV switches off. The screen stays black for about 10 seconds. Please, wait.

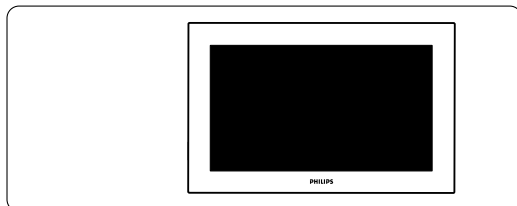

- 8 The TV switches back on again. The update is done.

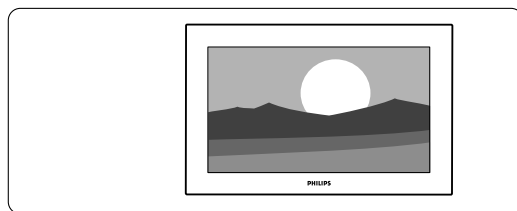

5.11.2 Software update by digital broadcast (DVB-T)

Your TV might receive new software from the digital broadcast system automatically.

If you receive an update message on screen it is strongly advised to update the software immediately - select **Now**.

If you want to be reminded later on, select **Later**. Select **Cancel** to quit the update (not recommended). If you cancelled the update you can still update yourself from the TV menu > Setup > Software update > Local updates.

6 Channel installation

The first time you turned on your TV

- you have selected the language of the TV menus and the country where you are located
 - all the available TV Channels have been installed.
- This chapter provides instructions on how to reinstall channels as well as other useful channel installation features.

Note:

Re-installation updates the All channels list and new added channels will not be added to any favourite list.

6.1 Automatic installation

This section describes how to search for and store all available channels automatically.

Step 1: Menu language

Sets the language of the TV menus. Go to a next step if your language settings are correct.

- 1 Press **Menu**.
- 2 Select **Setup > Installation > Languages** and press **▶** to enter **Menu language**.
- 3 Press **▲** or **▼** to select your language.
- 4 Press **OK** to confirm.
- 5 Press **◀** to return to the Installation menu.

Installation	Languages
Languages	Menu language
Channel install...	Primary audio
Preferences	Secondary audio
Connections assist.	Primary subtitles
Rename devices	Secondary subtitl.
Audio setup	Primary teletext
Decoder	Secondary teletext
...	Hearing impaired
	Pref. audio format

The Languages menu also offers the following language settings when digital channels are installed and broadcasted.

- **Preferred audio language**
Select one of the available audio languages as primary preferred and secondary preferred language.
- **Preferred subtitle languages**
Select one of the available subtitle languages as primary preferred and secondary preferred language. See section **5.8 Subtitles**.

- **Preferred teletext languages**
Select one of the available teletext languages as primary referred and secondary preferred language.
- **Hearing impaired**
Select **On** to display the hearing impaired subtitle version of your preferred audio or subtitle language when available.
- **Preferred audio format**
Select your preferred and available audio format to achieve the best sound reproduction. Select **Advanced** for the best sound reproduction if a Home theatre system is connected to your TV. Select **Standard** in all other cases.

Step 2: Select your country

Select the country where you are located. The TV will install and arrange the TV channels according to the country selected. Go to a next step if your country selection is correct.

- 1 Press **▼** to select **Channel installation**.
- 2 Press **▶** to enter the Channel installation menu. **Automatic installation** is highlighted.
- 3 Press **▶** to enter.
- 4 Press **OK**.
The Country list appears.
- 5 Press **▲** or **▼** to select your country.
- 6 Press **Next**.

Channel install...	Automatic install...
Automatic install...	Start now
Installation update	
Start-up message	
Antenna/Cable	
Digital: Test recept...	
Analogue: Manual...	
Rearrange	

Step 3: Install TV and radio channels

Your TV will search for and store all available digital and analogue TV channels and all available digital radio channels.

- 1 Select **Start**.
The installation may take a few minutes.
- 2 When the installation is done, press **Finish** to return to the Channel installation menu.
- 3 Press **Menu** to quit the menu.

Tip

When digital channels are found, the list of installed channels may show some empty channel numbers.

If you want to rename, reorder or uninstall stored channels, see section **6.3 Rearrange channels**.

Step 4 Clock, time zone and daylight saving selection

Only available when the country selected supports digital broadcasts.

Go to a next step if this step is not applicable.

- 1 Press ▼ to select **Clock**.
- 2 Press ► to enter:
- 3 Press ▲ or ▼ to select **Auto clock mode**.
- 4 Press ► to enter:

Installation	Clock
...	Auto clock mode
Preferences	Time zone
Connections assist.	Daylight saving
Rename devices	
Audio setup	
Decoder	
Clock	
Factory settings	

Auto clock mode

Select **Automatic** to instruct your TV to always get the time correctly. Time zone and Daylight saving correction are automatically set.

Select **Manual** when Universal Time Coordinated (UTC) is not available in your area.

Time zone/Daylight saving

When you selected Auto clock mode manually, select your local time zone and choose between **Standard** (winter) and **Daylight saving time** (summer).

6.2 Analogue: Manual installation

You can tune-in analogue TV channels channel by channel manually with Manual installation.

6.2.1 Select the system

- 1 Press **Menu**.
- 2 Select Setup > Installation > Channel installation > **Analogue: Manual installation**.
- 3 Press ► to enter the Manual installation menu. **System** is highlighted.
- 4 Press ► to enter the System list.
- 5 Press ▲ or ▼ to select your country or part of the world where you are now located.
- 6 Press ◀ to return to the Manual installation menu.

Channel install...	Analogue: Manual...
Automatic install...	System
Installation update	Search
Start-up message	Fine tune
Digital: Test recept...	Store current ch...
Analogue: Manual...	Store as new ch...
Rearrange	

6.2.2 Search for and store a new channel

- 1 Press **Menu**.
- 2 Select Setup > Installation > Channel installation > Analogue: manual installation > **Search**.
- 3 Press ► to enter the Search menu.
- 4 Press the red key to enter the frequency yourself or press the green key to search for a next channel.

Tip

If you know the frequency, enter the three numbers of the frequency with the number keys of the remote control.

- 5 Press ◀ when the new channel has been found.
- 6 Select **Store as new channel** to store the new channel under a new channel number.
- 7 Press ► to enter:
- 8 Press **OK**. **Done** appears.
- 9 Press **Menu** to quit the channel installation menu.

6.2.3 Fine tune a channel

Fine tune a found channel when the reception is poor:

- 1 Press **Menu**.
- 2 Select Setup > Installation > Channel installation > Analogue: manual installation > **Fine tune**.
- 3 Press **▶** to enter the Fine tune menu.
- 4 Press **▲** or **▼** to adjust the frequency
- 5 Press **◀** when you finished fine tuning.
- 6 Select **Store current channel** to store the fine tuned channel under the current channel number.
- 7 Press **▶** to enter.
- 8 Press **OK**. **Done** appears.
- 9 Press **Menu** to quit the Channel installation menu.

6.3 Rearrange stored channels

To rename, reorder, uninstall or reinstall stored channels.

6.3.1 Rename a channel

Assign or change a channel name to a channel for which a name has not yet been entered.

- 1 Press **Menu**.
- 2 Select Setup > Installation > Channel installation > **Rearrange**.
- 3 Press **▶** to enter the channel list.
- 4 Press **▲** or **▼** in the channel list to select the channel you want to rename.
- 5 Press the red key.
- 6 Press **◀** or **▶** to select a character or **▲** or **▼** to change the characters. Space, numbers and other special characters are located between **z** and **A**.
- 7 Press the green key or **OK** to finish.

Tip

To delete all characters, press the yellow key.

To delete the highlighted characters, press the blue key.

6.3.2 Uninstall or reinstall a channel

To uninstall a stored channel so that it is no longer possible to tune to.

Reinstall an earlier uninstalled channel.

- 1 Press **Menu**.
- 2 Select Setup > Installation > Channel installation > **Rearrange**.

- 3 Press **▶** to enter the channel list.
- 4 Press **▲** or **▼** in the channel list to select the channel you want to uninstall or reinstall.
- 5 Press the green key to uninstall or reinstall the channel.
- 6 Press **Menu** to quit the menu.

6.3.3 Reorder the channels

Change the order of the stored channels.

- 1 Press **Menu**.
- 2 Select Setup > Installation > Channel installation > **Rearrange**.
- 3 Press **▶** to enter the channel list.
- 4 Press **▲** or **▼** in the channel list to select the channel you want to reorder.
- 5 Press the yellow key to move up the highlighted channel in your channel list.
- 6 Press the blue key to move down the highlighted channel in your channel list.
- 7 Press **Menu** to quit the menu.

6.4 Channel management

6.4.1 Automatic search

Once a day, early in the morning, the TV searches for all available TV channels automatically. Leave your TV in standby.

Earlier found channels are updated and new channels are stored. Channels not found by the search anymore are removed from the channel list. When Channel management has found or removed channels, a message at TV start up is shown. You can activate or deactivate this message.

- 1 Press **Menu**.
- 2 Select Setup > Installation > Channel installation > **Startup message**.
- 3 Select **On** or **Off**.

6.4.2 Manual search

You can install the updates at any time.

- 1 Press **Menu**.
- 2 Select Setup > Installation > Channel installation > **Installation update**.
- 3 Press **▶** to enter the Installation update menu.
- 4 Press **OK**.
- 5 Press the green key to start.
The update starts and may take a few minutes.
- 6 When the update is completed, press the red key to return to the Channel installation menu.
- 7 Press **Menu** to quit the menu.

6.5 Digital reception test

If you receive Digital TV broadcasting you can verify the quality and signal strength of a specific channel.

- 1** Select a channel.
- 2** Press **Menu**.
- 3** Select Setup > Installation > Channel installation > **Digital: Test reception**.
- 4** Press **▶** to enter
- 5** Press **OK**.
- 6** Press the green key to start the test. Information on the quality and the signal strength of this channel is shown.
- 7** Use the cursor keys to change the frequency to improve the signal or enter a new frequency directly with the digit keys.
- 8** Press the green key to store the frequency if the signal quality and strength are good.
- 9** Press the red key to return to the Channel installation menu.
- 10** Press **Menu** to quit the menu.

Tip

To achieve the best results, contact a specialised antenna installer.

6.6 Factory settings

You can want to return to the original factory settings. Only picture and sound settings are reset.

- 1** Press **Menu**.
- 2** Select Setup > Installation > **Factory settings**.
- 3** Press **▶** to enter the Factory settings menu.
- 4** Press **OK**.
- 5** Press **Menu** to quit the menu.

7 Connections

7.1 Connection overview

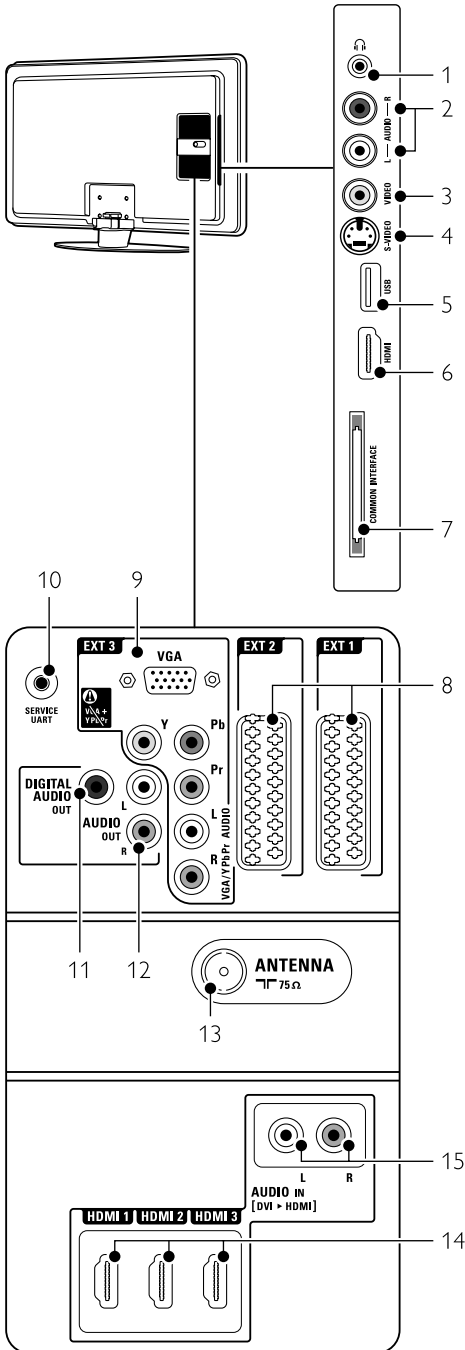

Side connectors

- 1 **Headphones**
Stereo Mini jack
- 2 **Audio L/R**
Audio L/R input to be used together with Video or S-Video on the side of the TV.
- 3 **Video**
Video input to be used together with the Audio L/R on the side of the TV.
- 4 **S-Video**
S-Video input to be used together with the Audio L/R on the side of the TV.
- 5 **USB**
USB connector.
- 6 **HDMI Side**
HDMI input
- 7 **Common interface**
Slot for Conditional Access Modules (CAM)

Back connectors

- 8 **EXT1, EXT2**
Scart connectors for DVD, VCR, Digital receiver, Game console, etc.
- 9 **EXT3**
Component Video Y Pb Pr and Audio L/R connectors for DVD, Digital receiver or Game console, etc.
VGA and Audio L/R connectors for a PC.
- 10 **Service UART**
For service only.
- 11 **Digital Audio Out**
Sound output cinch connector for a Home Theatre System, etc.
- 12 **Audio Out L/R**
Sound output cinch connectors for a Home Theatre System, etc.
- 13 **Antenna input**
- 14 **HDMI 1, HDMI 2, HDMI 3**
HDMI input connectors for Blu-ray Disc player, HD Digital receiver or HD Game console, etc.
- 15 **Audio L/R In [DVI to HDMI]**
Audio In L/R connectors to be used together with a DVI to HDMI connection.

7.2 About connections

7.2.1 What you need to know

Connect your device with the highest possible quality connection.

Look for the highest quality connection on your device. Use that connection to your TV.

HDMI - Highest quality ★★★★★

An HDMI connection has the best picture and sound quality. One cable combines video and audio signals. Use HDMI for HD (High Definition) TV signals. HDMI with EasyLink offers easy operating of your connected devices when these have the HDMI CEC standard. See section 7.2.2 EasyLink. A device connected with HDMI to the TV can only send out audio and video signals to your TV. The device cannot receive or record audio and video from your TV.

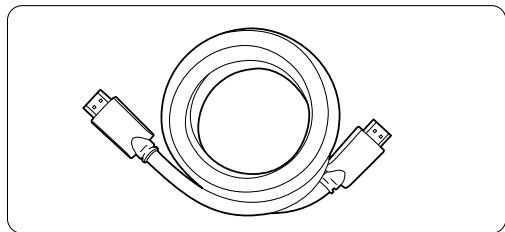

HDMI cable (max. 5m)

Tip

DVI to HDMI – Higher quality ★★★★★

Use a DVI to HDMI adaptor if your device has only a DVI connection.

Connect an Audio L/R cable to Audio In L/R (DVI to HDMI) for sound.

You need to assign this Audio In (DVI to HDMI) connector to the HDMI 1, 2 or 3 connector you are using for this device. See section 7.5.2 Audio setup.

Note

HDMI supports HDCP (High-bandwidth Digital Contents Protection). HDCP is a copy protection signal that comes with HD content (DVD disc or Blu-ray Disc).

YPbPr – Higher quality ★★★★★

Use the Component Video YPbPr connections together with Audio Left and Right. Match the cable colours when you connect.

YPbPr can handle HD TV signals.

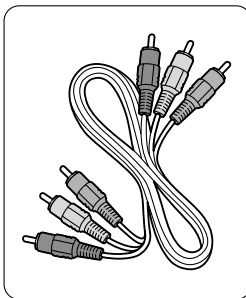

Component Video YPbPr cable
- Red, Green, Blue

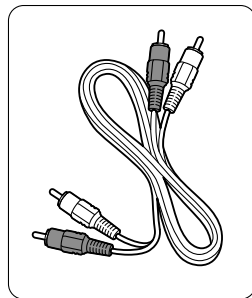

Audio L/R cable
- Red, White

Scart - Good quality ★★★

One cable combines video and audio signals.

Scart connectors can handle RGB video but no HD TV signals.

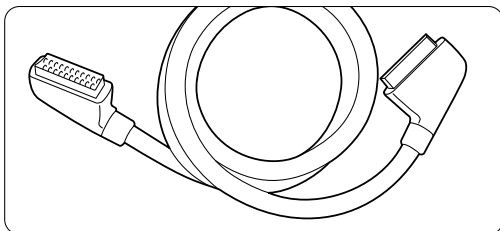

Scart cable

S-Video - Good quality ★★

Use an S-Video cable together with an Audio L/R (cinch) cable. Match the cable colours when you connect.

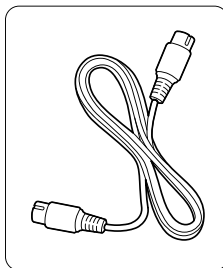

An S-Video cable

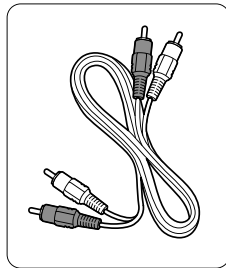

Audio L/R cable
- Red, White

Video - Basic quality ★

Use a Video (cinch) cable together with an Audio L/R (cinch) cable. Match the cable colours when you connect.

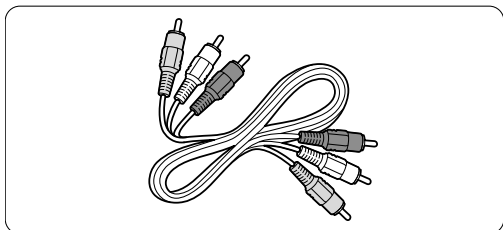

Combined Video - yellow and Audio L/R cable - red and white

7.2.2 HDMI with EasyLink

Connected devices that are compliant with the HDMI CEC standard can work together:

- 1 Press **Menu** > Setup > Installation > Preferences and press **▶** to enter the list.
- 2 Press **▲** or **▼** to select **EasyLink**.
- 3 Press **▶** to enter.
- 4 Press **▲** or **▼** to select **On** or **Off**.
- 5 Select **On** to activate EasyLink.

EasyLink might not work with devices from other brands.

One touch play

Insert a DVD disc and press Play. The TV switches on from standby and shows the DVD programme automatically.

System standby

Press the **⏻** key on the remote control for more than 2 seconds to switch the connected devices in standby.

System audio control

When you connect an audio system you can listen to the sound from your TV through your audio system while the TV speakers are muted. See section **5.4.5 Sound settings, TV speakers**.

ⓘ Note

Ensure that the System audio control in your HDMI-CEC audio devices (for ex. Home Theatre System) is properly set up.

7.2.3 Display synchronised audio out

For the best match of image and sound in speech on screen, connect a Home Theatre System to Audio Out L/R or Digital Audio outputs. See diagrams **7.4.4** and **7.4.8**.

Do not connect the audio signal of a DVD player, digital receiver or other audio/video device directly to the Home Theatre System.

7.3 Connect with the Connection assistant

(if available)

Use the Connection assistant to show you how to connect your devices to your TV. It sets all necessary settings automatically.

You can also connect your devices without the use of the Connection assistant. See section **7.4 Connect without the Connection assistant**.

- 1 Press **Menu**.
- 2 Select Setup > Installation > **Connection assistant**.
- 3 Press **▶** to start the Connection assistant.
- 4 Press **OK**.

7.4 Connect without the Connection assistant

The connections shown in this section are recommendations for the most used cases. Other solutions are possible.

When a device is connected the TV needs to know what connection you made. See section **7.5 Connection setup**.

7.4.1 DVD player

Use a scart cable to connect the device to the EXT1 input at the back of the TV.

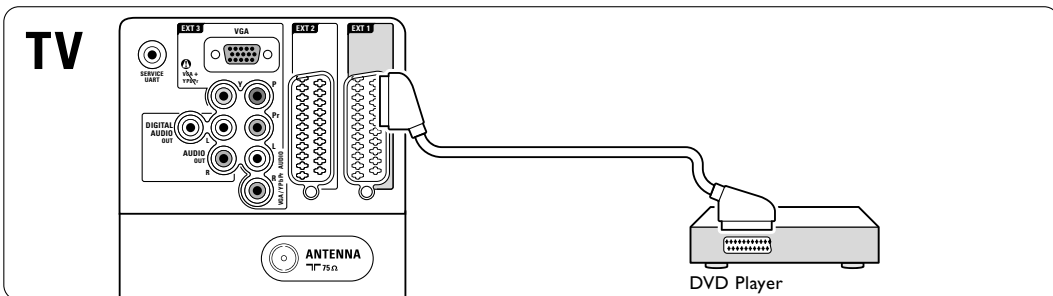

7.4.2 DVD Recorder or Digital Receiver

Use a scart cable and 2 antenna cables.

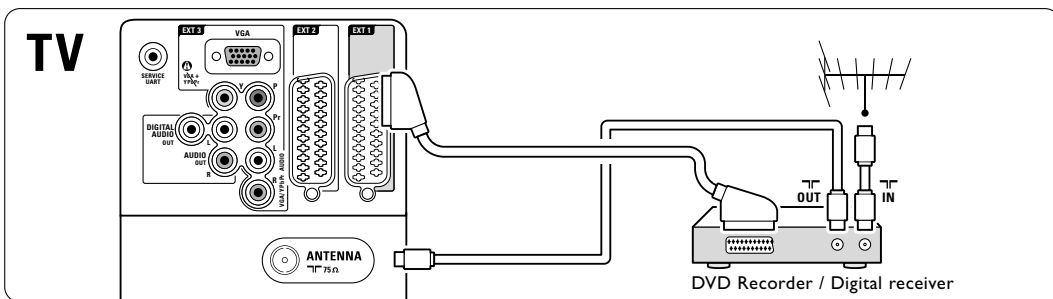

7.4.3 DVD Recorder and Digital Receiver

Use 3 scart cables and 3 antenna cables.

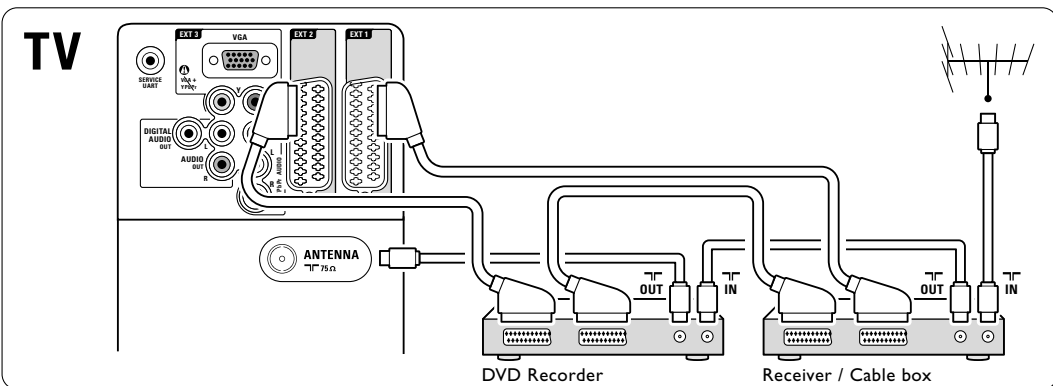

7.4.4 DVD Recorder and Home Theatre System

Use a scart cable, 2 antenna cables and 1 digital audio (cinch) cable.

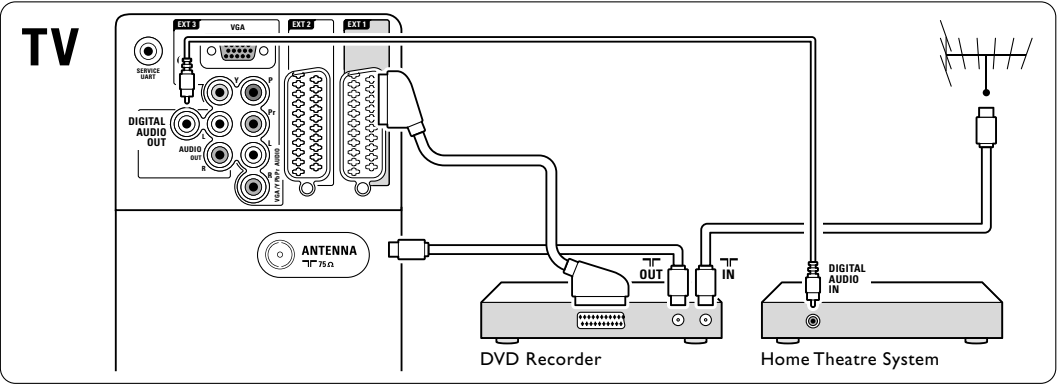

7.4.5 DVD Recorder and DVD Home Theatre System

Use 2 scart cables, 2 antenna cables and 1 digital audio (cinch) cable.

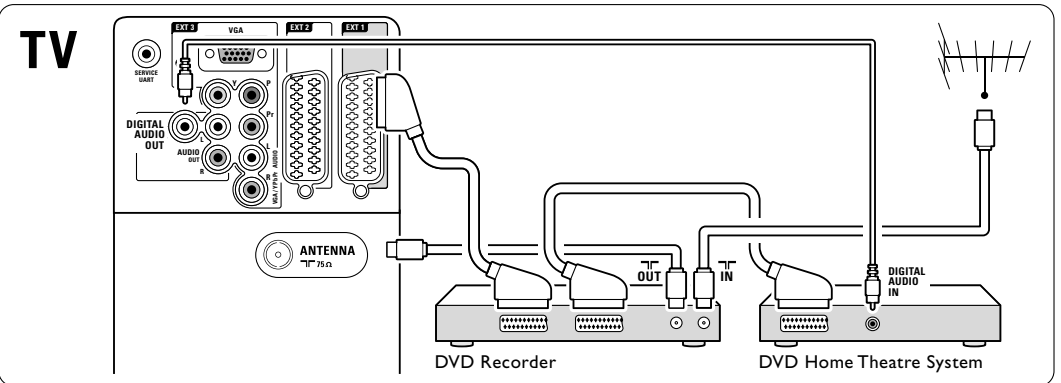

7.4.6 Satellite receiver

Use a scart cable and 2 antenna cables.

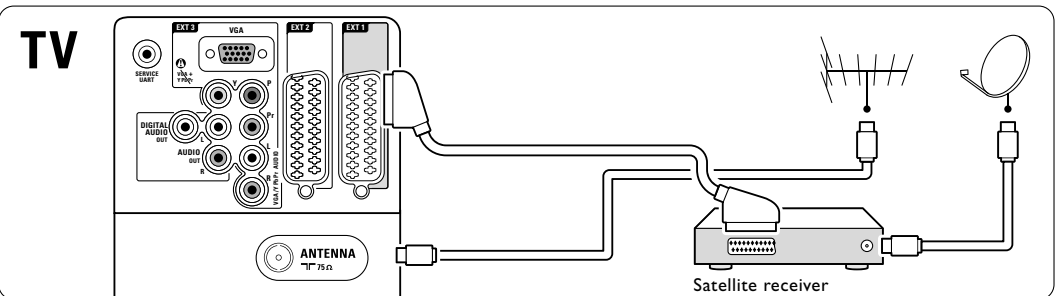

7.4.7 HD Digital receiver / HD satellite receiver

Use an HDMI cable and 2 antenna cables.

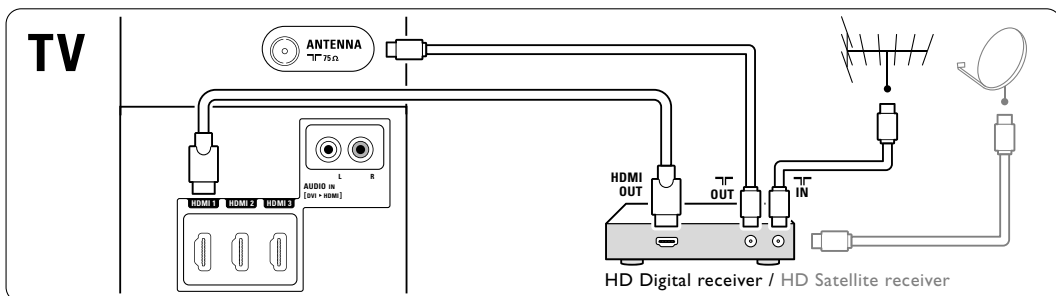

7.4.8 DVD-R, Home Theatre System and Digital receiver

Use 3 scart cables, 3 antenna cables and 1 audio (cinch) cable.

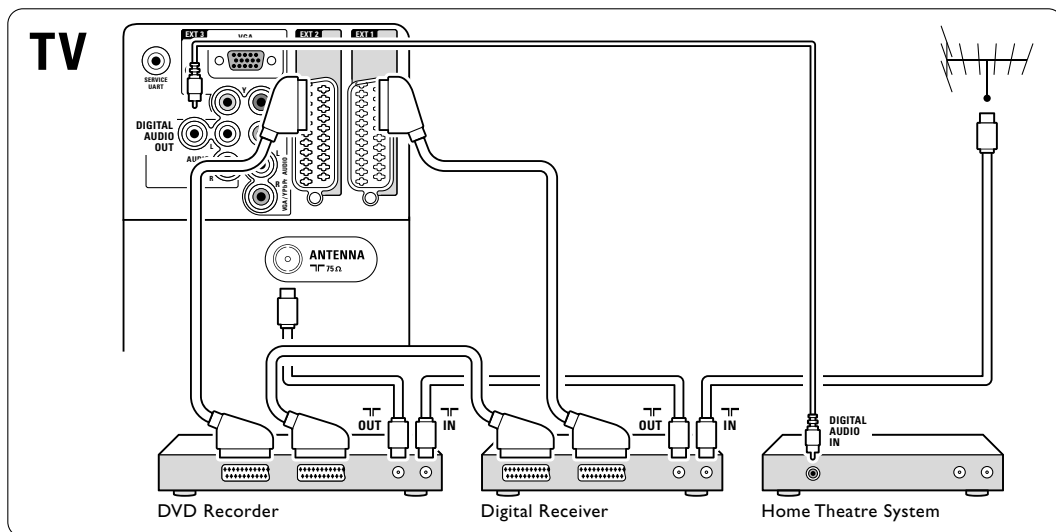

7.4.9 Blu-ray Disc player

Use an HDMI cable.

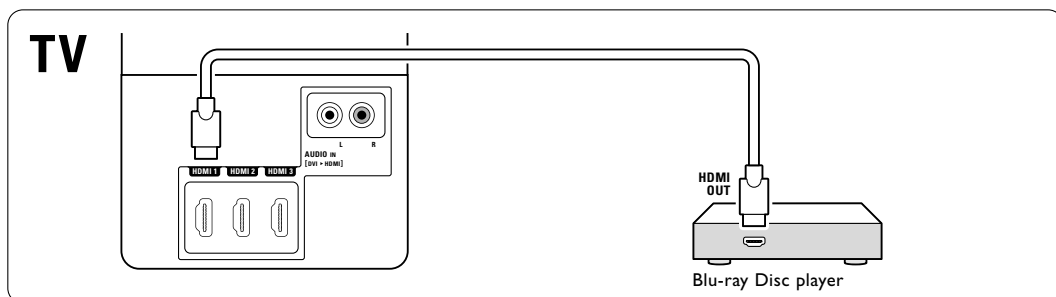

7.4.10 Game console

The most practical connections for a game console are at the side of the TV.

Connected at the side of the TV

Use the HDMI connection or the S-Video and Audio L/R connections or the Video and Audio L/R connections.

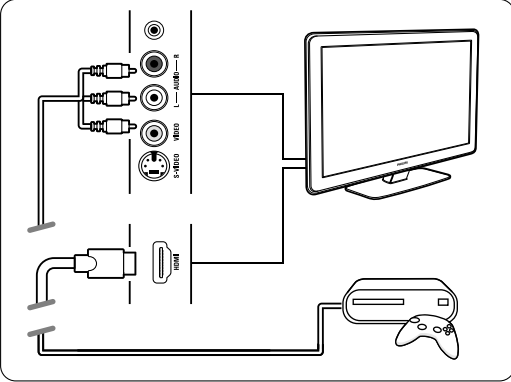

Connected at the back of the TV

Use an HDMI connection or the EXT3-YPbPr and Audio L/R connections for HD quality

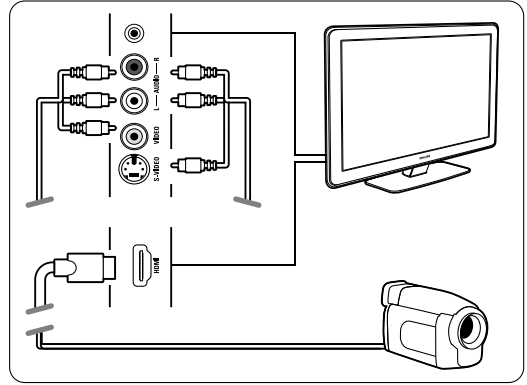
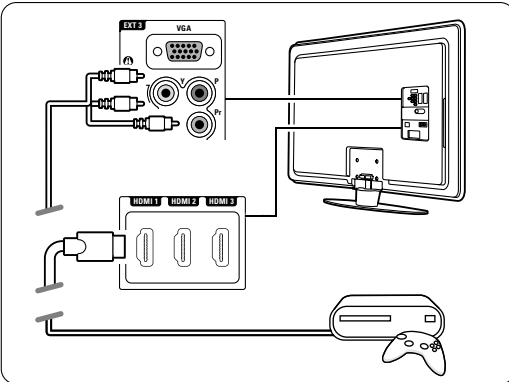

Connected at the back of the TV

Use an HDMI connection or the EXT3-YPbPr and Audio L/R connections for HD quality.

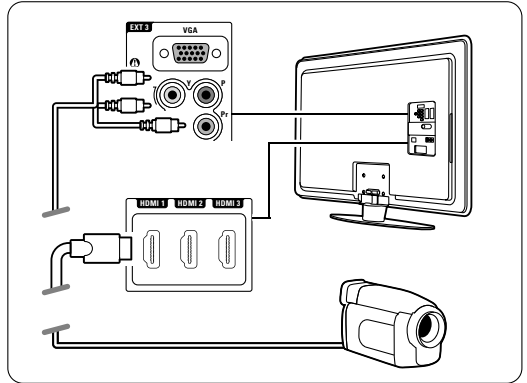

7.4.11 Camcorder

The most practical connection for a camcorder is at the side of the TV.

Connected at the side of the TV

Use the HDMI connection or the Video and Audio L/R connections or use the S-Video and Audio L/R connections.

7.4.12 Personal Computer

You can connect your PC directly to the TV. The TV works as a monitor of your PC.

As a monitor the PC can be connected at the side with a DVI to HDMI adaptor or with a PC to TV cable. Alternatively you can connect the PC at the back with the VGA connection.

⚠ Caution

Before connecting the PC, set the PC monitor refresh rate to 60Hz.

➕ Tip

Set the TV picture format to **Unscaled** in the Picture format menu for maximal PC picture sharpness. See section 5.3.4 **Widescreen picture format**.

DVI to HDMI connection

Use a DVI to HDMI adaptor to connect to the HDMI side connection.

Connect the Audio L/R at the side for sound.

VGA connection

Use a VGA cable to connect the PC to the EXT3 connection at the back of the TV.

Connect the Audio L/R to the EXT3 Audio L/R.

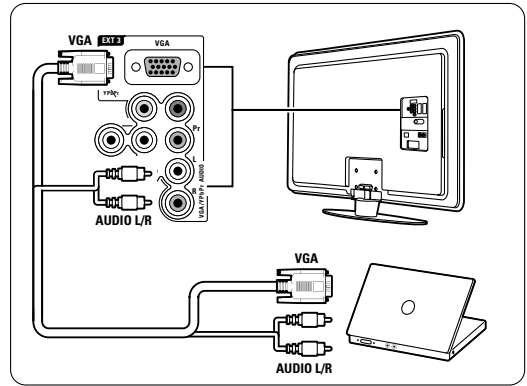

For supported PC monitor resolutions, see section 8 **Technical data**.

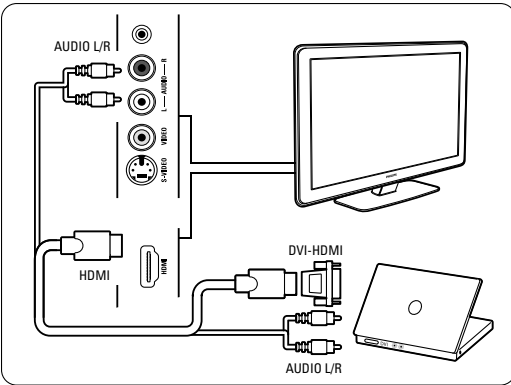

PC to TV connection

Use a PC-TV out cable to S-Video and Audio L/R cable to connect to the side of the TV.

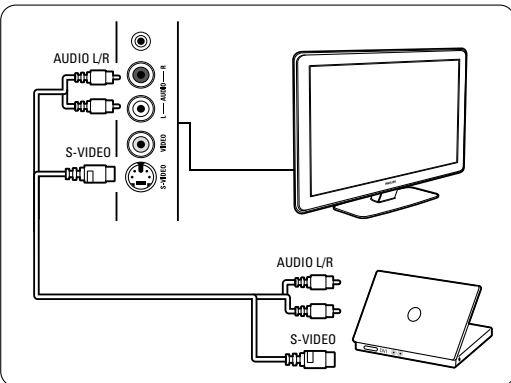

7.5 Connection setup

The TV needs to know what connections you have made and which device is connected to which connector.

If you have used the Connection assistant the connection setup is already done.

7.5.1 Naming your devices

Name the connected devices for easy selection and best signal handling.

Assign the type of device (DVD, VCR, Game, ...) to the connector you use for that device.

- 1 Press **Menu**.
- 2 Select Setup > Installation > **Rename devices**.
- 3 Press **▶** to enter the list.
- 4 Press **▲** or **▼** to select the connector you used for the device you connected.
- 5 Press **▶**.
- 6 Press **▲** or **▼** to select the type of device.
- 7 Press **Menu** to quit the menu.

7.5.2 Audio setup

If you use the Audio In L/R (DVI to HDMI) connector for a device connected to HDMI at the back of the TV, assign this Audio In to the HDMI 1, 2 or 3 where the device is connected.

- 1 Press **Menu**.
- 2 Select Setup > Installation > **Audio setup**.
- 3 Press **▶** twice.
- 4 Press **▲** or **▼** to select the HDMI connection to link with this Audio In.

Audio setup	Audio in L/R
Audio in L/R	None
	HDMI 1
	HDMI 2
	HDMI 3

7.5.3 Decoder channels

Decoders that decode an antenna channel are connected to **EXT1** or **EXT2** (scart).

You have to assign the TV channel as a channel to be decoded. Then assign the connection where the decoder is connected

- 1 Press **Menu**.
- 2 Select Setup > Installation > Decoder > **Channel**.
- 3 Press **▶** to enter the list.
- 4 Press **▲** or **▼** to select the channel to decode.
- 5 Press **◀** and go back to select **Status**.
- 6 Press **▲** or **▼** to select the connector used by the decoder.
- 7 Press **Menu** to quit the menu.

Installation	Decoder
...	Channel
Preferences	Status
Connections assist.	
Rename devices	
Audio setup	
Decoder	
Clock	
Factory settings	

7.6 Preparing for digital services

Scrambled digital TV channels can be decoded with a Conditional Access Module (CAM) and a Smart card provided by a digital TV service operator. The CAM may enable several services depending on the operator you choose (e.g. Pay TV).

Contact your digital TV service operator for more information and terms.

7.6.1 Insert a Conditional Access Module - CAM

Warning

Switch off the TV before inserting the CAM.

Look on the CAM for the correct inserting direction. Incorrect insertion can damage the CAM and the TV.

- 1** Gently insert the CAM into the **Common Interface** slot at the side of your TV as far as it will go.
- 2** Leave the CAM in the Common Interface slot permanently.

It can take a few minutes before a CAM is activated. Removing the CAM will deactivate the digital TV service.

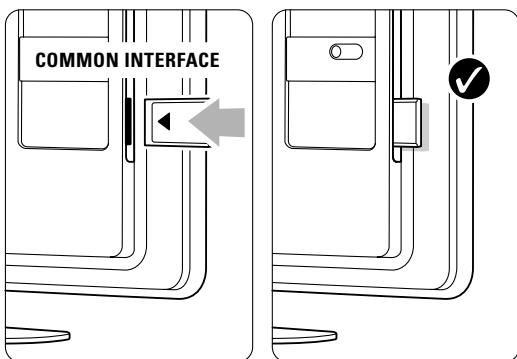

7.6.2 Common interface menu

From this menu you access the CAM service you have installed. The applications and their function, the content and the messages on screen come from the CAM service provider.

- 1** Press **Menu**.
- 2** Select **Features > Common interface**.

This menu option is available when a CAM is inserted and has made contact with the provider.

8 Technical data

Picture / Display

- Display type: LCD Full HD W-UXGA
- Panel resolution: 1920x1080p
- Pixel Plus picture enhancement
- 1080p 24/25/30/50/60Hz processing
- 100 Hz Clear LCD (if present)

Supported display resolutions

- Computer formats

Resolution	Refresh rate
640 × 480p	60Hz (VGA/HDMI)
600 × 800p	60Hz (VGA/HDMI)
1024 × 768p	60Hz (VGA/HDMI)
1280 × 768p	60Hz (VGA/HDMI)
1360 × 765p	60Hz (VGA/HDMI)
1360 × 768p	60Hz (VGA/HDMI)
1280 × 1024p	60Hz (HDMI)
1920 × 1080i	60Hz (HDMI)
1920 × 1080p	60Hz (HDMI)

- Video formats

Resolution	Refresh rate
480i	60Hz
480p	60Hz
576i	50Hz
576p	50Hz
720p	50Hz, 60Hz
1080i	50Hz, 60Hz
1080p	24Hz, 25Hz, 30Hz
1080p	50Hz, 60Hz

Tuner / Reception / Transmission

- Antenna input: 75ohm coaxial (IEC75)
- TV system: DVD COFDM 2K/8K, (MPEG2)
- Video playback: NTSC, SECAM, PAL
- DVD: DVB Terrestrial
(see selected countries on the TV typeplate)

Sound

- Sound system:
 - Virtual Dolby Digital
 - BBE

Multimedia

- Connections: USB
- Playback formats: MP3, Slideshow (.alb)
JPEG, MPEG1, MPEG2.

Supported USB/Memory device formats

- FAT 16, FAT 32, NTFS.

Remote control

- Type: RC2143605/01
- Batteries: 2 Size AA-R6-1,5V type

Connectivity

Back

- EXT1 (scart): Audio L/R, CVBS in, RGB
- EXT2 (scart): Audio L/R, CVBS in, RGB,
- EXT3: Y Pb Pr or VGA, Audio L/R
- HDMI 1 in (HDMI 1.3a for all HDMI connections)
- HDMI 2 in
- HDMI 3 in
- Audio In L/R (DVI to HDMI)
- Audio Out L/R - display synchronised
- Digital Audio out (coaxial-cinch-S/PDIF) - display synchronised

Side

- HDMI side in
- S-Video in (Y/C)
- Video in (CVBS)
- Audio L/R in
- Headphone (stereo mini jack)
- USB
- Common interface slot

Power

- Mains power: AC 220-240V (±10%)
- Power and standby power consumption:
See technical specification on www.philips.com
- Ambient temperature: 5°C - 35°C

Specifications are subject to change without notice.
For more specification details of this product see www.philips.com/support.

Dimensions and weights (approx.)

TV model	42PFL7403S/60
- width	1046mm
- height	645mm
- depth	88mm
- weight	± 21kg
TV + stand	
- width	1046mm
- height	716mm
- depth	262mm
- weight	± 25,5kg

9 Troubleshooting

Television and remote control

The TV does not switch on

- Verify the mains cord connection.
- Verify if the batteries of the remote control are not empty or weak. Verify their + / - orientation. You can use the keys on the TV to switch the TV on.
- Unplug the mains cord, wait a minute and plug it back in. Try again to switch on.

The TV does not react on the remote control

- Verify if the batteries of the remote control are not empty or weak. Verify their + / - orientation.
- Clean the remote control and TV sensor lens.

The TV switches off and the red light blinks

- Unplug the mains cord, wait a minute and plug it back in. Verify if there is enough space for ventilation. Wait until the TV has cooled down. When the TV does not restart to standby and the blinking occurs again, call our Customer Care.

You forgot your code to unlock Child lock

- See section 5.7.3 Set code / Change code.

Wrong language in the TV menu ?

Follow these steps to change the language.

- 1 Press **Menu** on the remote control.
- 2 Use **▼** to select the last menu line.
- 3 Press **▶** three times.
- 4 Press **▲** or **▼** to select your language.
- 5 Press **OK**.
- 6 Press **Menu** to quit the menus.

TV channels

Some TV channels are gone

- Verify if the correct channel list is chosen.
- A channel could be uninstalled in the **Rearrange menu**.

No digital channels found during installation

- Verify if the TV supports DVB-T in your country. See the label "Digital TV Country Compatibility" on the back of the TV.

Picture

The sound is on, but there is no picture

- Verify the contrast or brightness setting in the menu.

The TV picture is poor

- Verify if the antenna is connected properly.
- Non-earthed audio devices, neon lights, high buildings or mountains can influence the picture quality. Try to improve the picture by changing the antenna direction or place devices away from the TV.
- Verify if the correct TV system is chosen in the Manual installation menu.
- If only a certain channel is poor, try to fine tune this channel in the **Fine tune** menu. See section 6.2.3.

The picture has poor colour

- Verify the colour settings in the Picture menu. Select any of the Reset to standard settings in the **Smart settings** menu. See section 5.3.1.
- Verify the connections and cables of the connected devices.

The TV does not remember my settings when I switch back on

- Verify if the TV is set to **Home** in the TV menu > Setup > Installation > Preferences > **Location** menu.

The picture does not fit the screen, it is too big or too small

- Select a more fitting picture format in the Picture format menu. See section 5.3.4 **Widescreen picture format**.
- Name your connected device in the Connections menu to obtain the best signal handling. See section 7.4.1 **Naming your devices**.

The picture position on screen is not correct

- Some picture signals from some devices do not fit the screen correctly. You can shift the picture with the navigation key on the remote control. Verify the signal output of the device.

Sound

There is a picture but no sound

- Verify the volume is not set to 0.
- Verify the sound has not been muted with the  key.
- Verify if all cables are connected properly.
- If no sound signal is detected, the TV automatically switches off the sound.
This is proper operation and is not a malfunction.

The sound is poor

- Verify if the sound is set to Stereo.
- Verify the Equalizer in the Sound menu.
- Select any of the Smart settings in the menu.

The sound comes from one speaker only

- Verify if the Balance is not set to extreme left or right.

Sound delay when A HTS-DVD device is connected

- See the user manual of the HTS-DVD device to adjust the audio sync delay.
If you cannot set A delay, switch off HD Natural Motion in the Picture > Pixel Plus menu. See section **5.4.3 Picture settings**.

HDMI connections

Trouble with devices connected with HDMI

- The HDMI - HDCP procedure might take a few seconds before the TV shows the picture from a device.
- If the TV does not recognise the device and the screen shows no picture, try switching from one device to another and back again to restart the HDCP procedure.
- If sound interruptions occur persistently, see the user manual of the device to verify the output settings. If that does not help, connect an additional audio cable.
- If a DVI to HDMI adaptor is used, verify if an additional audio connection is in place to complete the DVI connection.
- HDMI with EasyLink does not work
 - Verify if the connected device supports the HDMI CEC standard. See the user manual that comes with the device.
 - Verify if the HDMI cable is properly connected.
 - Verify if Easylink is activated in the Setup, Installation, Preferences menu.
 - Ensure that the System audio control in your HDMI CEC audio devices is properly set up. See the user manual that comes with your audio device.

USB connection

The TV does not show the USB device content

- Set your device (camera) to 'Mass Storage Class' compliant.
- The USB device may need specific driver software. Unfortunately this software cannot be downloaded to your TV.

I cannot see my files in the Multimedia menu.

- Not all audio and picture files are supported. See section **8 Technical data**.

Photo and music files do not playback smoothly

- The transfer performance of the USB device limits the transfer rate.

Personal computer

The PC display on my TV is not stable or is not synchronised

- Verify if the correct resolution mode is selected on your PC. See section **8 Technical data**.

PC files do not play

- See section 8 Technical data for supported file formats.

If your problem is not solved

Switch your TV off and on again, that may help. If not, call our Consumer Care or consult our website www.philips.com/support.

Find the Consumer Care telephone numbers on the back cover of this manual.

Please, have the TV Model and Product Number ready before you call.

You can find these numbers on the packaging label or on the typelabel on the back and bottom of the TV.

Warning

Never try to repair the TV yourself.

10 Index

100 Hz Clear LCD 5,13

A

Active control 13
 Advanced sharpness 13
 Analogue
 manual installation 27
 TV channels 27
 Antenna
 cable 7
 connect 7
 with devices 29
 Audio setup 37
 Auto clock mode 26
 Auto format 14
 Automatic installation 25
 Auto surround 15
 Auto Volume levelling 15

B

Balance
 sound 14
 Batteries 3,7
 Blacklevel 13
 Blu-ray Disc 34
 Brightness 12

C

CA module 38
 Cable
 HDMI 30
 Scart 30
 S-Video 30
 Video 31
 YPbPr 30
 Camcorder 35
 Camera (photo) 35
 Care of the screen 3
 Change code 19
 Channel
 all channels list 17
 favourite list 17
 installation 25
 lock 19
 Channel
 management 28
 up/down 11
 previous 12
 rearrange 28
 store / install 27

Child lock 19
 Clock 26
 Code 19
 Colour
 enhancement 13
 menu 12
 keys 4,10
 Common interface (CAM)
 menu 38
 slot 29,38
 Connection
 best 30
 overview 29
 set up 37
 Contrast 12
 Country selection 25
 Custom lock 19
 Custom tint 13

D

Daylight saving 26
 Decoder channel 37
 Delta volume 15
 Device
 connecting 31
 naming 37
 watch 9
 Digital
 audio out 29
 subtitle language 20
 receiver 32
 test reception 28
 Dual I/II 14
 Dual screen 11
 DVB-T 5
 DVD
 connect 32
 playback 9
 player 32
 recorder 32,33
 Dynamic
 backlight 13
 contrast 13

E

EasyLink 31
 Electronic Programme Guide 18
 Energy saving 12
 Equalizer 14

External 1,2,3 (EXT) 29

F

Factory settings 28
 Favourite channel lists 17
 Fine tune 27

G

Game console 35

H

HDMI connection 30
 HD digital receiver 34
 HD natural motion 13
 Headphone
 connect 4,29
 volume 15
 Hearing impaired 25
 Home theatre system 33
 Hue 12

I

Installation
 automatic 25
 manual 27
 menu 25
 update 28

K

Kensington Security Slot 5
 Key(s)
 colour 10
 on TV 4
 on remote control 4,10

L

Language
 menu 25
 audio 14
 Language
 subtitle 20
 Light sensor 13
 Location 40
 Locks 19

M

Menu key 11
 Mono 14
 Movie expand 14
 MPEG artefact reduction 13
 Music 21

Mute key 10

N

Naming devices 37

Noise reduction 13

O

OK key 10

On timer 19

P

Personal Computer

connect 36

display resolutions 39

Photo viewer 21

Picture

album 21

format 14

menu 13

Pixel Plus 13

Position the TV 5

Power cable 7

Preferred audio format 25

R

Radio channel 22

Rearrange channels 27

Recorder 32

Recycling 3

Remote control

batteries 7

overview 10

Rename 27

Reorder 27

S

Safety 3

Satellite receiver 34

Scart connection 30

Screen cleaning 3

Search

channels 27

teletext pages 16

Set code 19

Settings assistant 11

Sharpness 13

Sleeptimer 19

Smart settings 11

Software update 22

Sound

menu 14

surround mode 15

Standby 10,19

Super zoom 14

Stationary images 3

Stereo 14

Subtitle 20

language 20

shift 14

Switch on 8

T

Table of Pages T.O.P 15

Technical data 39

Teletext 15

digital 16

dual screen 16

language 15

menu 16

page 15

teletext 2.5 16

Time zone 26

Timers 19

Tint 13

Troubleshooting 40

TV speakers 14

U

Unscaled 14

USB

connector 29

device 20

photo viewer 21

V

VCR

connect 32

VGA 36

Video cable 31

Video formats 39

Volume

bar 14

key 10

W

Whitepoint 13

Widescreen picture format 14

Y

YPbPr 30

Contact information

Type no. _____

Product no. _____



België / Belgique 078 250 145	€0.06/min	Italia 8403 20086	€0.08/min	Svenska 08 5792 9100	Local
Danmark 3525 8759	Local	Luxembourg 40 6661 5644	Locale	Suomi 09 2311 3415	Local
Deutschland 01803 386 852	€0.09/min	Nederland 0900 8407	€0.10/min	United Kingdom 0870 900 9070	Local
France 0821 611 655	€0.09/min	Norge 2270 8111	Local		
ΕΛΛΑΣ 0 0800 3122 1280	Δωρεάν	Österreich 0810 000205	€0.07/min		
España 902 888 784	€0.10/min	Portugal 2 1359 1442	Local		
Ireland 01 601 1777	Local	Schweiz / Suisse / Svizzera 0844 800 544	Local		



Specifications are subject to change without notice
Trademarks are the property of Koninklijke Philips Electronics N.V.
or their respective owners
2008 © Koninklijke Philips Electronics N.V. All rights reserved

www.philips.com



Printed in Belgium