

Philips
Professional TV

39" Studio
DVB-T2/T/C HEVC

39HFL2869T



Delight your guests

with pure taste

Show your guests how much you care with this affordable Hospitality TV. You will enjoy dedicated hospitality features like a branded welcome page, installation via USB and menu and control locking.

Great viewing experience and guest comfort

- LED TV for images with incredible contrast
- Low power consumption
- USB for multimedia playback

Advanced hotel features and future proof

- Greet your guests with a customizable welcome page
- USB cloning of all settings for quick installation
- Off-line channel editor to edit a channel list on a PC
- One combined channel list for Analog and Digital channels
- Installation menu locking
- Prevent unauthorized use by joystick control locking
- Advanced volume control to avoid guest disturbance
- Ideally suited for prisons

PHILIPS

Highlights

Welcome page



A welcome page is displayed each time the TV set is switched on. The welcome page can be branded and customized easily at the time of installation via a simple welcome image in .png format.

USB Cloning

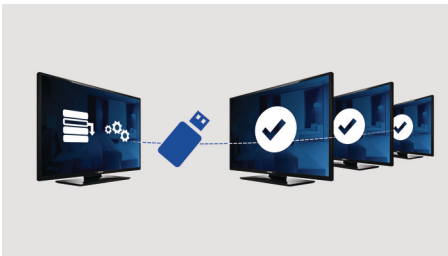

Provides the ability to easily copy all programming and channel programming settings from one TV into other TV sets in less than a minute. The feature ensures uniformity

between TV sets and significantly reduces installation time and costs.

PrisonMode

To control communication, this Hospitality TV is equipped with a specific PrisonMode setting. This Advanced Security Mode switches off certain settings not demanded by the detention market like Teletext, Electronic Programme Guide, Subtitles and USB ports.

USB (photos, music, video)



Share the fun. Connect your USB memory-stick, digital camera, mp3 player or other multimedia device to the USB port on your TV to enjoy photos, videos and music with the easy to use onscreen content browser.

One combined channel list

One integrated channel list for digital and analogue channels. This allows the guest to

zap seamlessly between Analogue and Digital channels.

Advanced volume control

With advanced volume control you can install the start-up volume of the TV and predetermine the volume range with which the TV set is allowed to operate, preventing excessive volume adjustments and avoiding disturbance of next door guests.

Joystick control locking

By disabling or enabling the joystick control locking, the administrator can prevent unauthorized use of the TV via the joystick, saving the hotelier overheads.

Installation menu locking

Prevents unauthorized access to installation and configuration settings, to ensure maximum guest convenience and avoid unnecessary reinstalling costs.

Low power consumption

Philips TVs are designed to minimize power consumption. This will not only reduce environmental impact but also lower operating costs.

Specifications

Picture/Display

- Display: LED HD TV
- Diagonal screen size: 39 inch / 98 cm
- Aspect ratio: 16:9
- Panel resolution: 1366 x 768p
- Brightness: 300 cd/m²
- Viewing angle: 178° (H) / 178° (V)

Audio

- Sound output Power: 12 (2x6) W
- Speakers: 2.0, Down Firing
- Sound Features: Equalizer, Balance, AVL, Incredible surround, Dynamic Bass

Design

- Colour: Black

Tuner/Reception/Transmission

- Digital TV: DVB-T/T2/C, HEVC FHD (up to 1080p60)
- Analog TV: PAL, SECAM

Connectivity Rear

- Antenna: IEC-75
- HDMI1: HDMI 1.4, ARC
- HDMI2: HDMI 1.4
- Digital Audio out: Optical
- Scart: CVBS, RGB, SVHS
- VGA input: 15 pin D-sub

Connectivity Side

- Common Interface Slot: CI+ 1.3
- AV input: CVBS+L/R (Cinch)
- Headphone out: Mini-Jack
- USB1: USB 2.0

Connectivity Enhancements

- EasyLink (HDMI CEC): One touch play, System Standby, RC pass through

Features

- Digital services: Subtitles, Teletext, MHEG, Now&Next, 8d EPG
- Ease of use: Picture Style, Sound Style
- Local control: Joystick

Hospitality Features

- Hotel mode: Joystick Control Lock, Menu lock, Installation Menu Lock, Volume limitation (incl.

HP)

- Prison mode: high security mode, TXT/MHEG/USB/EPG/Subtitle Lock
- Your brand: Welcome Logo
- Cloning and Firmware update: via USB, Instant Initial Cloning
- Switch On control: Channel/Source, Picture Style, Volume (incl. HP)
- Timer: Sleep Timer, Wake Up Alarm
- Channels: Combined List, Off-Line Channel Editor
- Control: Block Automatic Channel Update
- Power control: Green/fast startup
- Remote Control: Cable Strap Ready, RC Battery Door Lock
- Anti-Theft: Kensington Lock

Healthcare features

- Control: Multi-Remote Control
- Convenience: Headphone out

Multimedia

- Multimedia connections: USB
- Video playback supported: Containers: AVI, MKV, Formats: H.264/MPEG4 AVC, MPEG1, MPEG2, MPEG4, HEVC, TS
- Subtitle formats supported: SRT, SSA SUB, ASS, SMI, TXT
- Music formats supported: MP3, AAC, WAV, WMA (v2 up to v9.2)
- Picture formats supported: BMP, JPG, PNG
- Supp. Video Resolution on USB: up to 1920x1080p@30Hz

Accessories

- Included: Remote Control 22AV1407A/12, 2x AAA batteries, Tabletop Stand, Warranty Leaflet, Legal and Safety brochure
- Optional: Setup RC 22AV9573A, Remote Control 22AV1601A/12

Power

- Mains power: AC 220-240V; 50-60Hz
- Energy Label Class: A++
- Eu Energy Label power: 31 W
- Annual energy consumption: 45 kW h
- Standby power consumption: <0.3 W
- Power Saving Features: Eco mode
- Ambient temperature: 5 °C to 45 °C

Dimensions

- Set dimensions (W x H x D): 889 x 523 x 79/97 mm
- Set dimensions with stand (W x H x D): 889 x 563 x 220 mm
- Product weight: 6.6 kg
- Product weight (+stand): 7.5 kg
- VESA wall mount compatible: 200 x 200 mm, M6

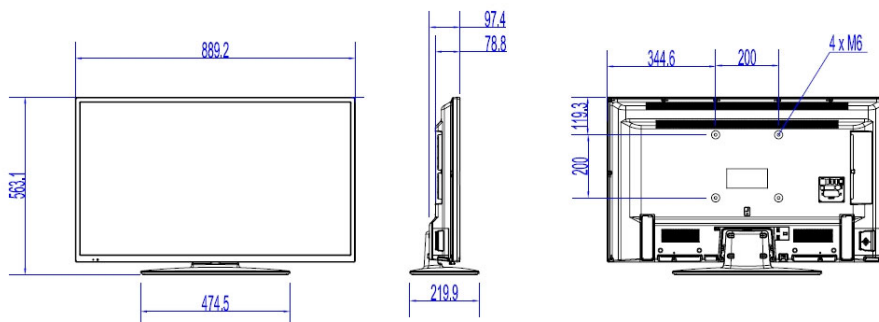

Issue date 2022-05-16

Version: 1.0.1

12 NC: 8670 001 47631
EAN: 87 18863 01381 6

© 2022 Koninklijke Philips N.V.
All Rights reserved.

Specifications are subject to change without notice.
Trademarks are the property of Koninklijke Philips N.V.
or their respective owners.

www.philips.com

* Availability of features will depend on implementation chosen by integrator.
* Typical on-mode power consumption measured according to IEC62087 Ed 2. The actual energy consumption will depend on how the television is used.
* This television contains lead only in certain parts or components where no technology alternatives exist in accordance with existing exemption clauses under the RoHS Directive.