

Philips Commercial Solutions

User Manual

26HF5545D
32HF5545D
32HF7945D
26HF7945D
42HF7945D
26HF7955H
32HF7955H



Thank you for choosing Philips.

Need help fast?

Read your Quick Use Guide and/or Owner's Manual first for quick tips that make using your Philips product more enjoyable.

*If you have read your instructions and still need assistance, you may access our online help at **www.philips.com/hospitality** or call **1-866-497-4225** while with your product (and Model / Serial number)*

For Customer Use

Enter below the Serial No. which is located on the rear of the cabinet. Retain this information for future reference.

Model No. _____

Serial No. _____

PHILIPS



Contents

Important Safety Instructions	2	Definitions, Acronyms and Abbreviations	31
Safety Information and Useful Tips ...	5	USA Limited Warranty	34
Before Calling Service	6	Who is covered?.....	34
Basic TV Connections	8	What is covered?.....	34
Antenna Connection.....	8	What is the period of coverage?.....	34
Mains Connection.....	8	What we will do to correct problems?...	35
Switching on the TV.....	8	What is excluded?	35
Use and Care of Optional Remote Controls	9	How to get warranty service in U.S.A., Puerto Rico or U.S. Virgin Islands? or Where can I get more information?.....	36
Overview of TV Connectors and Controls	10	Cleaning and Care	37
Optional Remote Controls	11	Environmental Care	37
RC2888/01	11	Index	38
Guest Remote Control Keys	12	Dolby Digital	39
Overview of TV Setup Main Menu / Sub-Menus	13	Kensington Security Slot	39
Accessing the Setup Menu	14		
Accessing TV Setup Menu using the Remote Control (RC2573GR).....	14		
Installation	15		
A. Selecting the language	15		
B. Selecting your Communication Source	15		
C. Changing the settings of a channel.....	15		
D. Tuning channels automatically	19		
E. Selecting Cable or Antenna mode.....	19		
F. Selecting Virtual or Physical Channel.....	19		
G. Enabling your current ring.....	20		
H. Setting up the options for Digital Channels	20		
I. Selecting and Configuring the settings and options	22		

Important Safety Instructions

Read before operating equipment

1. For the quickest and most trouble free installation, please consult the quick start guide that came packed in the Television (or download it from www.philips.com/hospitality if you have lost it).
2. Keep these instructions.
3. Heed all warnings.
4. Follow all instructions.
5. Do not use this TV near water.
6. Clean only with a dry, soft, non-abrasive cloth.
7. Do not block any of the ventilation openings. Install in accordance with the manufacturer's instructions.
8. Do not install near any heat sources such as radiators, heat registers, stoves, or other apparatus (including amplifiers) that produce heat.
9. Do not defeat the safety purpose of the polarized or grounding-type plug. A polarized plug has two blades with one wider than the other. A grounding type plug has two blades and a third grounding prong. The wide blade or third prong are provided for your safety. When the provided plug does not fit into your outlet, consult an electrician for replacement of the obsolete outlet.
10. Protect the power cord from being walked on or pinched particularly at plugs, convenience receptacles, and the point where they exit from the apparatus.
11. Only use attachments/accessories specified by the manufacturer.
12.  Use only with a cart, stand, tripod, bracket, or table specified by the manufacturer, or sold with the TV. When a cart is used, use caution when moving the cart/TV combination to avoid injury from tip-over.
13. Unplug this TV during lightning storms or when unused for long periods of time.
14. Refer all servicing to qualified service personnel. Servicing is required when the TV has been damaged in any way, such as power-supply cord or plug is damaged, liquid has been spilled or objects have fallen into apparatus, the TV has been exposed to rain or moisture, does not operate normally, or has been dropped.
15. This product may contain lead and mercury. Disposal of these materials may be regulated due to environmental considerations. For disposal or recycling information, please contact your local authorities or the Electronic Industries Alliance: www.eiae.org
16. **Damage Requiring Service** - The TV should be serviced by qualified service personnel when:
 - The power supply cord or the plug has been damaged; or
 - Objects have fallen, or liquid has been spilled into the TV; or
 - The TV has been exposed to rain; or
 - The TV does not appear to operate normally or exhibits a marked change in performance; or
 - The TV has been dropped, or the enclosure damaged.

Important Safety Instructions

Read before operating equipment

17. **Stand, Wall or Ceiling Mounting**

- Philips warrants that this product is safety tested and UL Certified when mounted with the enclosed stand or stands sold by Philips. No such warranties are made regarding third party mounts or stands.

18. **Power Lines** - An outdoor antenna should be located away from power lines.

19. **Outdoor Antenna Grounding** - If an outside antenna is connected to the receiver, be sure the antenna system is grounded so as to provide some protection against voltage surges and built up static charges. Section 810 of the National Electric Code, ANSI/NFPA No. 70-1984, provides information with respect to proper grounding of the mast and supporting structure, grounding of the lead-in wire to an antenna discharge unit, size of grounding connectors, location of antenna-discharge unit, connection to grounding electrodes, and requirements for the grounding electrode. See Figure below.

20. **Object and Liquid Entry** - Care should be taken so that objects do not fall and liquids are not spilled into the enclosure through openings.

21. **Battery Usage CAUTION** - To prevent battery leakage that may result in bodily injury, property damage, or damage to the unit:

- Install all batteries correctly, with + and - aligned as marked on the unit
- Do not mix batteries (old and new or carbon and alkaline, etc.)
- Remove batteries when the unit is not used for a long time.

Important Safety Instructions

Read before operating equipment

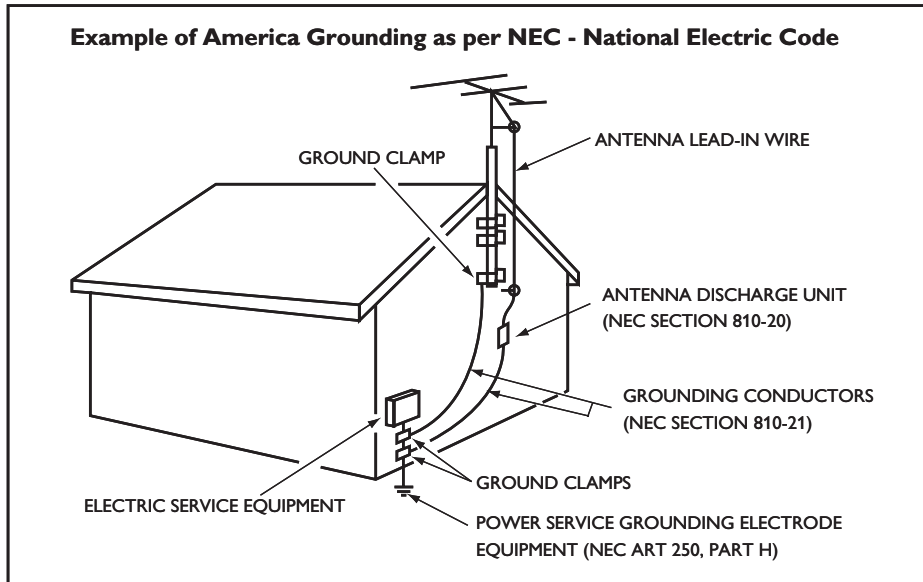

Know these safety symbols

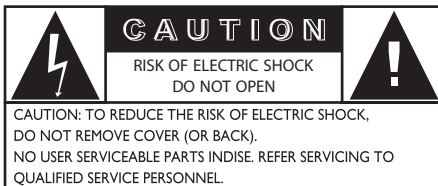

This “bolt of lightning” indicates material not insulated within your unit which may cause an electrical shock.

For the safety of everyone in your property, please do not remove product covering.

The “exclamation point” calls attention to features for which you should read the enclosed literature closely to prevent operating and maintenance problems.

WARNING: To reduce the risk of fire or electric shock, this appliance should not be exposed to rain or moisture and objects filled with liquids, such as vases, should not be placed on this apparatus.

CAUTION: To prevent electric shock, match wide blade of plug to wide slot, and fully insert.

ATTENTION: Pour éviter les chocs électriques, introduire la lame la plus large de la fiche dans la bome correspondante de la prise et pousser jusqu’au fond.

Safety Information and Useful Tips

1. Two people are required to lift and carry a TV that weighs more than 55 pounds. Improper handling of the TV can cause serious injury.
2. If you place the TV set on a solid surface. Ensure the surface is level and that it can withstand the weight of the TV.
3. Installing the TV on the wall requires special skill that should only be performed by a qualified personnel. You should not attempt to do the work yourself. Philips bears no responsibility for improper mounting or mounting that results in accident or injury. Make sure that the wall mount is being fixed securely enough so that it meets safety standards.
4. This TV is compatible with the VESA wall mounting standard. Please contact your local electronics supplier for a VESA compliant bracket to wall mount this TV. Before you mount your TV on a wall, ensure the wall is suitable to carry the weight of the TV.
5. Do not insert the power plug in the wall socket before all connections are made.
6. Do not touch any part of the TV, power lead, or aerial lead during lightning storms.
7. Do not leave the TV in stand-by mode for an extended period of time. Instead, disconnect the TV from the mains.
8. The TV set is always connected to the mains. Disconnection of the TV set can be done by:
 - unplugging the mains cord located at the back of TV set, or
 - unplugging the mains plug from the mains socket outlet.Pull the power lead by the plug - do not pull on the power lead.
9. Ensure the power cord is fully inserted into the TV mains socket and the wall socket.
10. If the TV is mounted on a swivel base or swivel arm, ensure no strain is placed on the power cord when the TV is swivelled. Strain on the power cord can loosen connections and cause arcing or fire.
11. Verify that the mains supply voltage in your location corresponds to the voltage printed on the sticker at the rear of the TV.

Before Calling Service

If you are experiencing problems, check this list of symptoms and suggested steps to take before requesting service. You may be able to solve the problem yourself.

Note: Please become familiar with the commercial features as described in TV installation / Setup because the effects of several of these features, if not thoroughly understood might appear as faulty operation.

	Symptoms	Suggested steps to take
<i>Installation</i>	<ul style="list-style-type: none"> TV does not respond to commands (volume, channel, power), or cannot be turned on (if it is off). Or cannot be turned off (if TV is on). 	<ul style="list-style-type: none"> Check commercial TV setup (TV installation / setup) menu, including power on, volume minimum / maximum features. See page 14 and 23.
	<ul style="list-style-type: none"> TV turns off by itself. 	<ul style="list-style-type: none"> TV automatically turns off after approximately 5 minutes when no RF signal is present (unless POWER ON = FORCED). See page 23. Check Energy Saving Programmability setting (see ESP) in TV installation / setup. See page 25.
<i>Picture</i>	<ul style="list-style-type: none"> No Picture 	<ul style="list-style-type: none"> Check that the antenna / cable is connected properly at the rear of the TV. Check Tuning Mode setting (Air / Cable). Possible TV station problem. Try another channel.
	<ul style="list-style-type: none"> There is picture but no sound 	<ul style="list-style-type: none"> Try increasing the volume. Check that the sound is not muted. If it is, press the MUTE button on the remote control to restore sound.

Before Calling Service

	Symptoms	Suggested steps to take
Picture Display	<ul style="list-style-type: none"> • Uneven color display. 	<ul style="list-style-type: none"> • Ensure that the TV is not placed near any speakers or magnetic objects.
	<ul style="list-style-type: none"> • Double image / "ghost" image 	<ul style="list-style-type: none"> • Check antenna, cable or set-top box.
	<ul style="list-style-type: none"> • Snowy / noisy picture 	<ul style="list-style-type: none"> • Check antenna, cable and / or setup box connections. Ensure that they are properly connected.
	<ul style="list-style-type: none"> • Poor or no picture 	<ul style="list-style-type: none"> • Possible electrical interference from appliances or other sources. • Check picture adjustments (brightness, contrast, color, tint).
Sound	<ul style="list-style-type: none"> • No Sound 	<ul style="list-style-type: none"> • Check if the volume of TV is not at the minimum. Try pressing the Volume + button of the remote control to increase sound. • Check that the mute mode is not on. If mute mode is on, press the Mute button on the remote control to deactivate mute mode.
Power	<ul style="list-style-type: none"> • No power 	<ul style="list-style-type: none"> • Ensure that the TV's AC power cord is plugged into the main socket and to your TV. If there is still no power, disconnect the plug. Wait for 60 seconds and re-attach plug. Turn on the TV again.
Remote Control	<ul style="list-style-type: none"> • TV does not respond to remote control 	<ul style="list-style-type: none"> • Try changing the batteries. • Aim remote control directly at remote control sensor lens on TV and try pressing any button on the remote control.

Basic TV Connections

Antenna Connection

Connect the antenna or RF cable signal to the 75 ohm RF 'F' connector socket located on the TV.

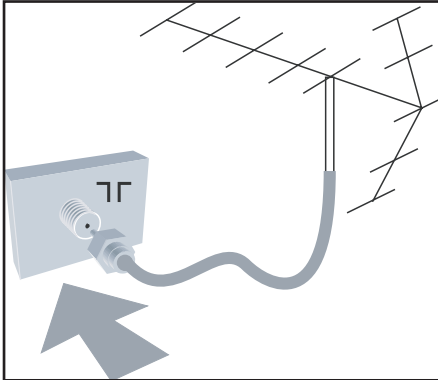

Mains Connection

Ensure that the mains voltage and frequency are correct. Please refer to the product labelling and documentation.

Note: The power button on the TV does not disconnect the television from the AC mains. It toggles the TV between on and stand-by mode. To completely turn off the AC mains power, you must unplug the AC mains plugs from the wall socket.

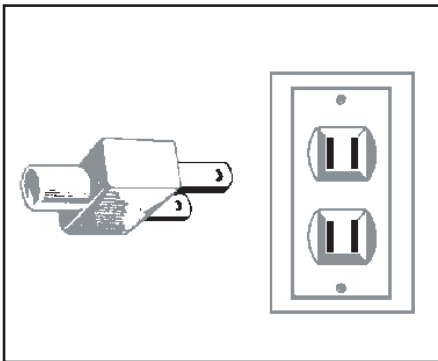

Switching on the TV

Press the power button on the TV or on one of the optional remote controls to switch the TV set on.

Note: If the TV is in commercial mode, it might not respond to the front panel or the remote control. Please refer to the section on **TV Installation** and **TV Setup Menu** in this documentation for more information.

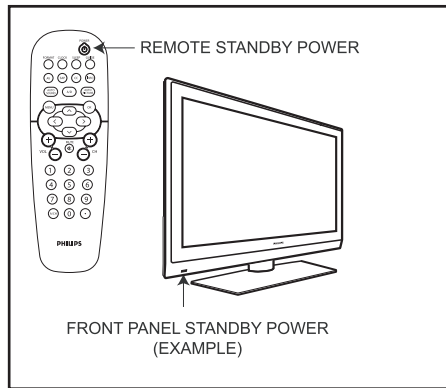

Use and Care of Optional Remote Controls

To load batteries into the remote control:

- Remove the battery compartment lid from the back of the remote control.
- Insert two AA-sized batteries into the battery compartment, making sure the positive + and negative - polarity line up correctly as indicated inside the case.
- Re-attach the battery compartment lid.

Note: Always remove batteries from the remote control if it is not used for a long period of time. This is to prevent damage to the remote control due to battery leakage.

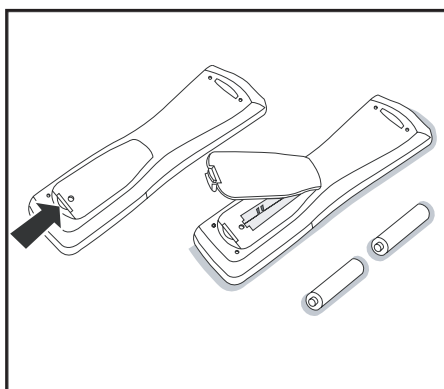

Overview of TV Connectors and Controls

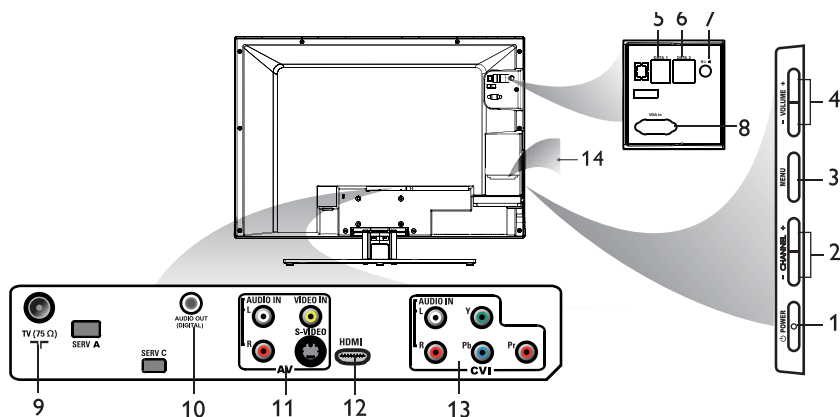

⚠ Warning :

- Risk of electric shock. Rear jack panel must be removed by qualified personnel only.
- Do not connect any telephone cables or equipment to Data 1 (RJ12) & Data 2 (RJ45) connectors.

1. **POWER**

To switch the TV on and off. To disconnect from the mains, remove the mains cord from the mains socket at the back of the TV or remove the mains plug from the wall socket.

2. **- CHANNEL +**

To select a channel.

3. **MENU**

To display or close menus.

4. **- VOLUME +**

To increase or decrease volume.

5. **Data 1 (RJ 12)**

For Pay Per View Terminal connection.

6. **Data 2 (RJ 45)**

For Smartcard XpressBox connection.

7. **8 Ω Speaker**

To connect to bathroom speaker (for 7955D model only) and pendant control (for 7955H model only). A stereo jack must be used.

8. **VGA In**

For PC/Lap-top VGA input.

9. **TV Aerial**

To connect to the aerial plug.

10. **Audio Out**

To connect to an amplifier with coaxial digital output.

11. **Audio / Video Inputs**

To connect to video camera or camcorder. Only one video connection can be used at a time.

12. **HDMI**

To connect to peripheral equipment, including high-definition equipment.

13. **Component Video Inputs/Audio Inputs**

To connect to DVD or decoder which have the same connectors.

14. **Smart Card Slot**

(Applicable to certain models only).
For use with compatible 32 pin smart card.

Optional Remote Controls

The following remote controls are applicable to Philips Business Display Solutions TV products. These can be used for setup and configuration purposes.

RC2888/01

Guest Mode Remote Control (optional)



RC2573GR is an optional remote control for Institutional TV / Business Display Solutions features and Smart Card settings. It can be purchased separately.

Slide this button up to enter into **Guest mode**.

or

Slide this button down to enter into **Setup mode**.

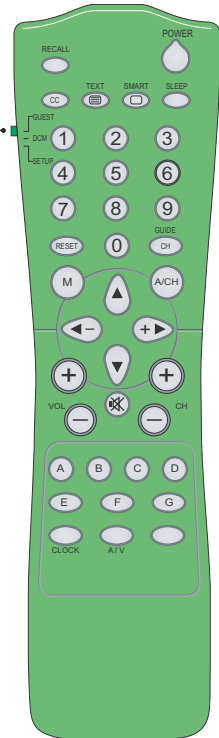

Guest Remote Control Keys

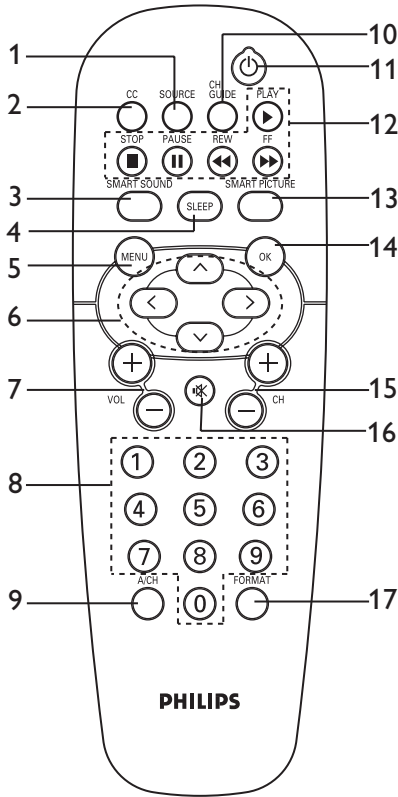

1. **Source Select**
To toggle between available video sources.
2. **Closed Caption**
To activate the Closed Caption function.
3. **Smart Sound**
To select the predefined sound settings.
4. **Sleep**
To activate the sleep timer. Press the button repeatedly to increase countdown time.

5. **Menu**
To call up or exit the menus.
6. **Navigation cursors**
To navigate through the menus/ submenus.
7. **Volume + / -**
To adjust the TV volume.
8. **0 to 9 Digit keys**
To select a TV channel. For a two digit number, enter the second digit before the dash disappears.
9. **Alternate Channel**
To toggle between the alternate channels
10. **Channel Guide**
To activate the channel guide function.
11. **Standby**
Power the TV off or on.
12. **DVD keys** (if applicable)
 - To pause DVD playback.
 - ▶ To start DVD playback.
 - To pause DVD playback.
 - ◀◀ To fast forward DVD playback
 - ▶▶ To fast forward DVD playback.
13. **Smart Sound**
To select predefined sound settings.
14. **OK**
To confirm a selection.
15. **Channel + / -**
To select channels.
16. **Mute**
To turn off or on sound.
17. **Format**
To select TV screen formats.

Overview of TV Setup Main Menu / Sub-Menus

SETUP

—	LANGUAGE	—————	ENGLISH, ESPANOL, FRANCAIS
—	COMMUNICATION		
	COMMUNICATION	—————	SP - SPI, SP - I2C, HM -LINK, SERIAL XPRESS, MULTI RC, SMART RC, OFF
	STORE	—————	>
	DCM TYPE	—————	GENERIC, NO SOURCE SWITCH
—	CHANNEL INSTALL		
	CHANNEL	—————	TV 2
	INPUT	—————	TUNER, AV, SVIDEO, CVI, VGA, HDMI, *CARD CVBS, *CARD-YC, *CARD CVI
	CHANNEL LOGO	—————	>
	DIGITAL	—————	NO, YES
	RINGS	—————	(1) (2) (3) (4)
	LABEL	—————	() >
	MUTE	—————	NONE, AUDIO, VIDEO
—	AUTO INSTALL TV	—————	START
—	CABLE TUNING	—————	NO, YES
—	USE CHANNEL TABLE	—————	NO, YES
—	CURRENT RING	—————	RING1, RING2, RING3, RING4
—	DIGITAL SETUP	—————	CHANNEL SETUP, AUDIO, DIGITAL CC, EMERGENCY ALERT
—	CONFIGURATION	—————	SWITCH ON / OSD, PICTURE / SOUND, SECURITY, CONTROL, VIDEO ADJUSTMENT, FEATURES, CC / V-CHIP

* **CARD CVBS, CARD-YC, CARD CVI** are available on certain models only.

Accessing the Setup Menu

The following remote control commands are applicable to Philips Business Display Solutions TV products. These can be used for setup and configuration purposes.

ACCESSING TV SETUP MENU USING THE REMOTE CONTROL (RC2573GR)

1. Slide the button to the **Setup** location.

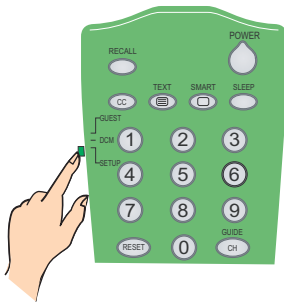

2. Press the **M** button on the remote control to activate the TV Setup Menu.

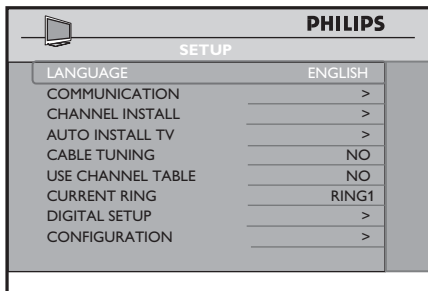

To scroll through the menu :

1. Press the **^** or **v** button on the remote control. A highlight indicates that the respective menu item's setting is selected for modification.
2. Press the **>** to modify the setting of the selected menu item.
3. To exit menu, press the **M** button on the remote control.

Installation

A. Selecting the language

You can select **ENGLISH**, **ESPAÑOL** or **FRANCAIS** as your preferred language.

- Press the > button repeatedly to select your preferred language.

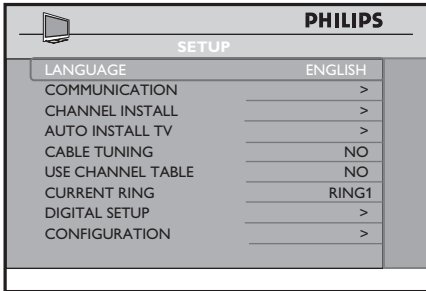

B. Selecting your Communication Source

There are seven options in the **COMMUNICATION** menu which can be selected by using the < > buttons on the remote control.

They are **SP - SPI**, **SP - I2C**, **HM - LINK**, **SERIAL XPRESS**, **MULTI RC**, **SMART RC** and **OFF**. The factory default is **SP-SPI** and this is correct for most systems.

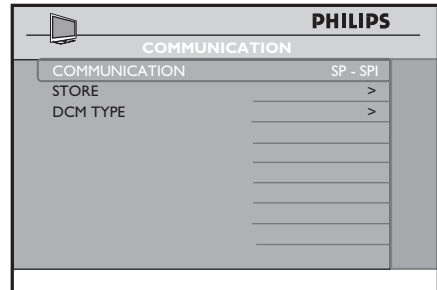
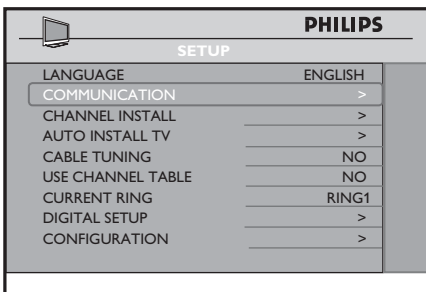

- Select **SP - SPI**, **SP - I2C**, **HM - LINK** or **SERIAL XPRESS** options to allow you to identify a connection link between the TV Display and the setup box.
- For **SP - SPI** and **SP - I2C**, select **GENERIC** under **DCM TYPE** if the set-top box requires source switch.
- As for **MULTI RC**, select this option to use the specified color code to correspond to the remote control.
- Select **SMART RC** option to access the **SMOOVIE** functionality on this TV set.
- Proceed to select **STORE** and store all your selections.

C. Changing the settings of a channel

This feature allows you to change settings for a particular channel.

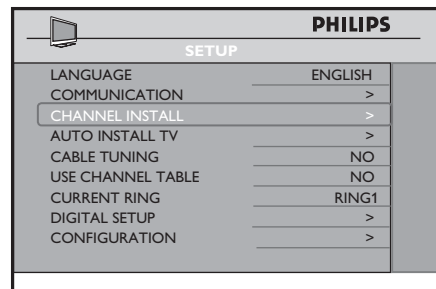

Installation

1. Press the > button to enter into the **CHANNEL INSTALL** menu.

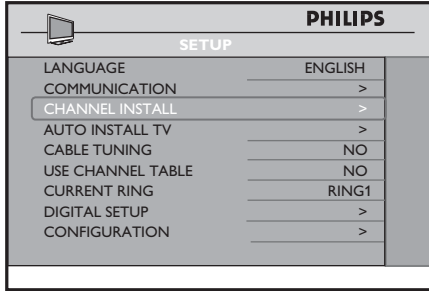

- Press the > button to enter into the **CHANNEL INSTALL** menu.

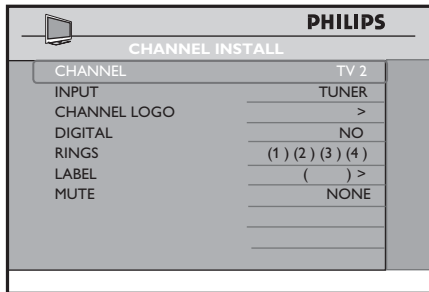

2. Selecting a channel

- Select the channel by using the Digit 0 - 9 buttons.
- For **Cable** mode, channel selection is from 01 - 250.
- For **Antenna** mode, selection of channel is from 02 - 250.
- In order to input a three digit channel, the TV must be configured to allow three digit channel entry. Please see page 26 under “**3 DIGIT ENTRY**” for instructions on how to do this.

3. Selecting an input source

- Select **TUNER, AV, SVIDEO, CVI, VGA, HDMI, CARD-CVBS, CARD-YC or CARD CVI**.
Note : Card-YC, Card CVI, and Card CVBS are available on certain models only.
- If **TUNER** is selected, you can assign a logo to the channel (refer to **CHANNEL LOGO** section below). You can also access **DIGITAL** options (refer to **DIGITAL** section on page 18).

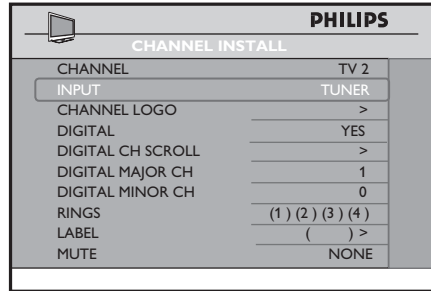

4. Assigning a channel logo / text to the channel

- Press the > button to enter into the **CHANNEL LOGO** mode display

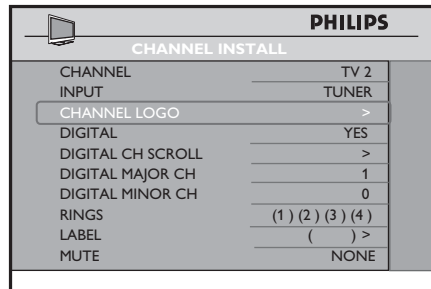

- Use **P + / -** to access the available logo pages and the < > ^ v buttons to navigate and select the logo.

Installation

- Press the **Digit 0** button on your remote control to confirm selection.
- You can also choose to input text for the selected channel. Press Digit 5 on your remote control to use keyboard
- Use the < > ^ v buttons to navigate and select the character and press **Digit 0** to input text. Repeat step until you have completed your input of text.

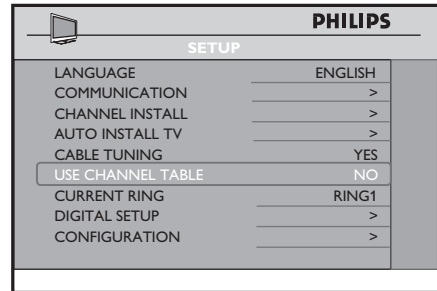

5. Selecting Digital Channel Options

- If the current channel you are mapping is a digital or high definition channel, use the < > buttons to select **YES**. Selecting **NO** will remove the **DIGITAL CH SCROLL**, **DIGITAL MAJOR CH** and **DIGITAL MINOR CH**. Since the channel is not digital, these options will not appear in the menu.

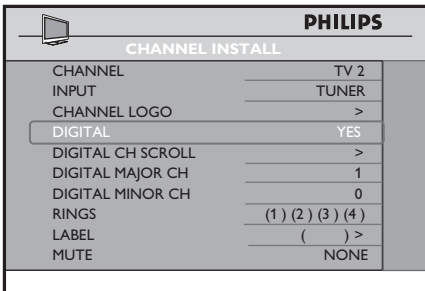
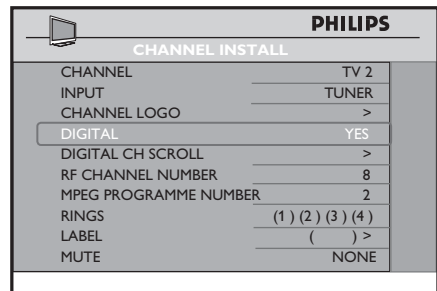

- If **NO** is selected in the **USE CHANNEL TABLE** (see page 19), the options for **DIGITAL MAJOR CH** and **DIGITAL MINOR CH** are replaced with the options of **RF CHANNEL NUMBER** and **MPEG PROGRAM NUMBER**.

6. Scrolling the Digital Channels

- If **NO** is selected, press the < > buttons to go the previous or next digital channel.

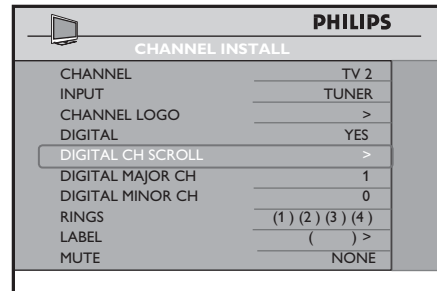

Installation

7. Searching the Digital Major Channels / RF Channel Number

- For **DIGITAL MAJOR CH / RF CHANNEL NUMBER**, key in the channel number (1 to 999) using the **Digit 0 - 9** buttons.

8. Searching the Digital Minor Channel / MPEG Program Number

- For **DIGITAL MINOR CH / MPEG PROGRAM NUMBER**, use the **Digit 0 - 9** buttons to key in the channel number (0 to 999).
- Press the < button from **Channel 0** to select **NO**.
- If **NO** is selected, go back to **DIGITAL MAJOR CH. / RF CHANNEL NUMBER** to enter one part channel number.
- Use the **Digit 0 - 9** buttons to key in the channel number (1 to 16383).

9. Selecting your preferred ring

There are four groups of rings. Each ring comprises a group of channels.

- Press the < > buttons to select preferred ring. A red dash will appear beside the selected ring.
- Press the ^ v buttons to confirm selection. A "X" will appear beside the ring.
- Press the **(M)** button to save and exit ring mode.

PHILIPS	
CHANNEL INSTALL	
CHANNEL	TV 2
INPUT	TUNER
CHANNEL LOGO	>
DIGITAL	YES
DIGITAL CH SCROLL	>
DIGITAL MAJOR CH	1
DIGITAL MINOR CH	0
RINGS	(1X) (2) (3) (4)
LABEL	() >
MUTE	NONE

10. Naming a channel

You can assign a name to a channel.

- Press the < > buttons to move to the first character slot. A red dash will appear.
- Press the ^ v buttons to key in the first character.

PHILIPS	
CHANNEL INSTALL	
CHANNEL	TV 2
INPUT	TUNER
CHANNEL LOGO	>
DIGITAL	YES
DIGITAL CH SCROLL	>
DIGITAL MAJOR CH	1
DIGITAL MINOR CH	0
RINGS	(1X) (2) (3) (4)
LABEL	(S P O _)
MUTE	NONE

- Press the < > buttons to move to the next character slot and continue to key in the next character (maximum of 8 characters).
- Press the **(M)** button to save and exit label mode.

11. Selecting the Mute Source

You can choose to mute the Audio or the Video.

- Press the < > buttons to select **NONE, AUDIO** or **VIDEO**.

Installation

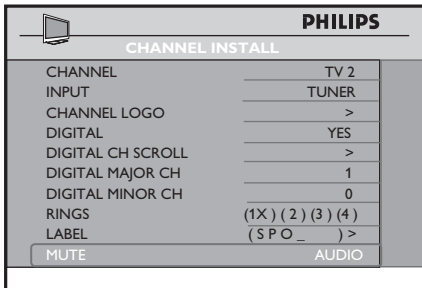

D. Tuning channels automatically

1. Press the > button to enter **START** mode.

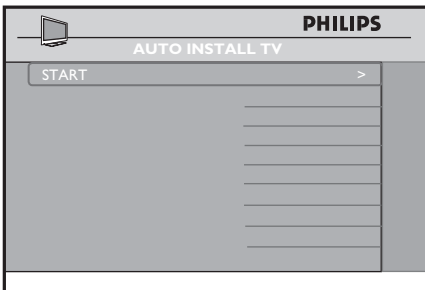
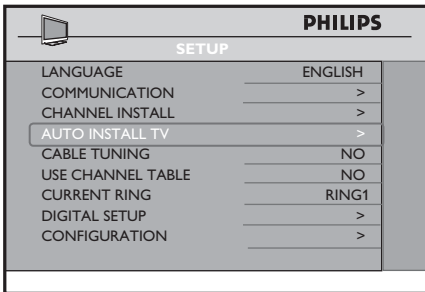

2. Press the > button again to start automatic installing of channels.
Note : To interrupt automatic installing of channels, press any button on the remote control.

E. Selecting Cable or Antenna mode

1. Select **YES** to use **Cable** mode and **NO** to use **Antenna** mode.

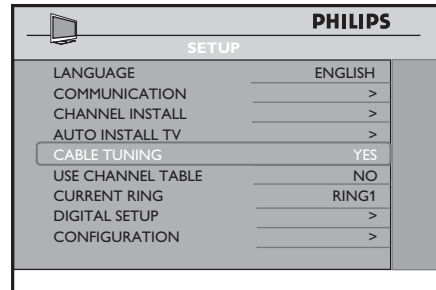

F. Selecting Virtual or Physical Channel

The **USE CHANNEL TABLE** option relates to the use of Virtual channels versus Physical channels.

1. Select **NO** to use Physical channel number as most PPV systems mandate that the TV use Physical channels.

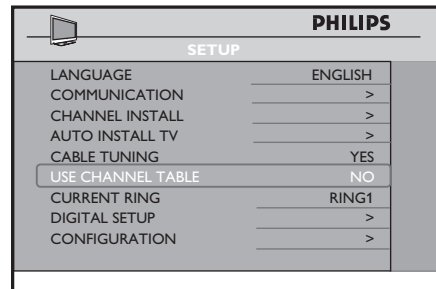

2. Select **YES** for a stand alone system where the channels are tuned and ordered by their Virtual channel numbers.

Installation

Most HD stations are assigned Physical channel numbers that differ from their traditional analog channel numbers. So the channel you know as Channel 2, is actually broadcasting its HD signal on a physical channel unrelated to Channel 2, say 19.1 for example. Selecting **YES** will cause the HD broadcast of Channel 2 to appear as Channel 2.1, the virtual channel instead of the physical location of the broadcast, 19.1.

G. Enabling your current ring

Four groups of **RING** are available.

1. To enable **CURRENT RING**, select from **RING1** to **RING4**.
2. If "**SMART RC**" is selected under **COMMUNICATION** source (see page 15, "**Selecting your Communication Source**"), then **RING 4** will not be available.

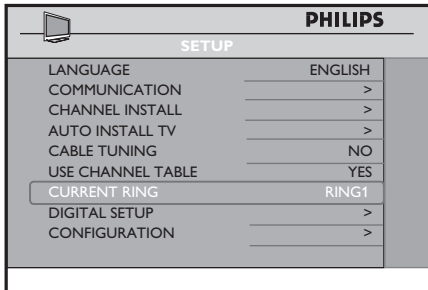

H. Setting up the options for Digital Channels

- Press the > button to enter the **DIGITAL SETUP** mode.

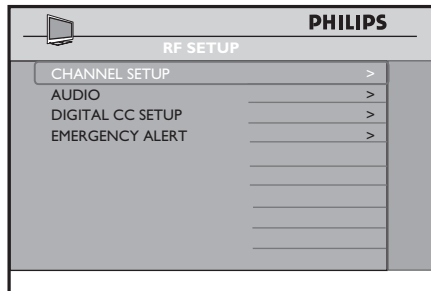
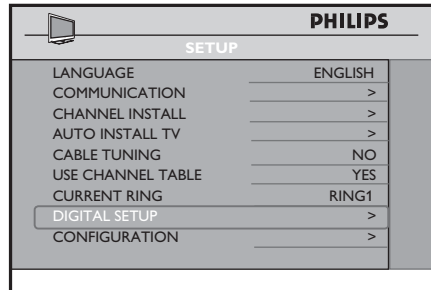

1. Setting up the VCHIP / DIGITAL RATING and FACTORY CH RESET

- Press the > button to enter the **CHANNEL SETUP** mode.

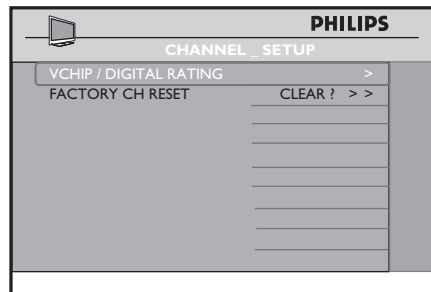

VCHIP / DIGITAL RATING

allows you to configure and enable content restrictions on the TV based upon the VCHIP STANDARD (see www.fcc.gov/vchip/ for more information on ratings).

Installation

FACTORY CHANNEL RESET allows you to clear the digital channel map. **Note** : You need to do an automatic installation after **FACTORY CHANNEL RESET** is confirmed.

- Press the \wedge \vee buttons to select the item you want to configure.
- Press the $<$ $>$ buttons to select option.

2. Selecting the Digital Audio language

Allows you to select your preferred digital audio language (English, Spanish or French).

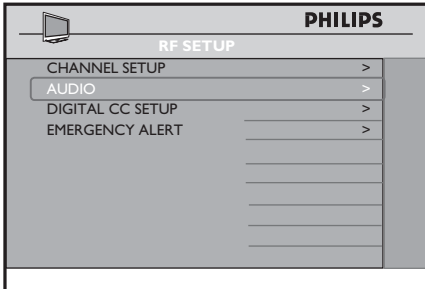

- Press the $>$ button to enter the **AUDIO** mode.

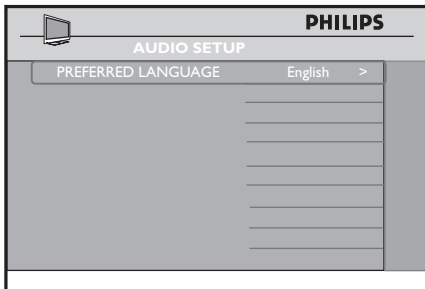

- Press the $>$ button to enter the Preferred Language mode and select your preferred language.

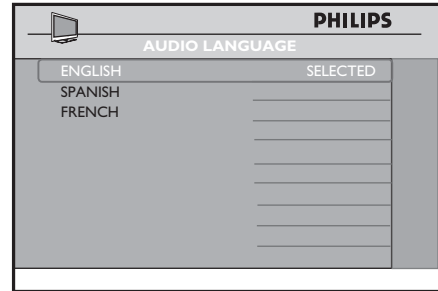

3. Selecting the Digital Closed Caption options

DIGITAL CLOSED CAPTION SETUP allows you to select the default Closed Captioning option and also configure the digital text / background properties of digital CC.

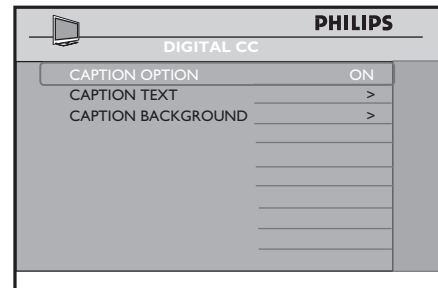
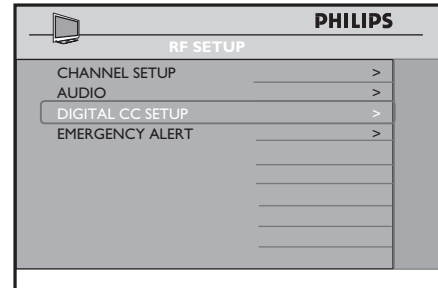

Installation

- Press the > button to enter the **DIGITAL CC SETUP** menu and select your default Closed Captioning option and also configure the digital text / background properties of digital CC.

4. Activating the Emergency Alert

Use this option to enable or disable **MEDIUM** to **LOW** alert.

- Press the > button to enter the **EMERGENCY ALERT** menu and select **MEDIUM** or **LOW**.

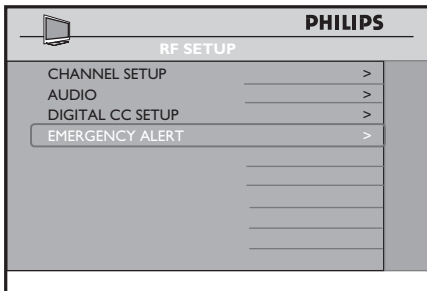

- Press the ^ v buttons to select **MEDIUM** or **LOW**.
- Press the < > buttons to select **ON** or **OFF**.

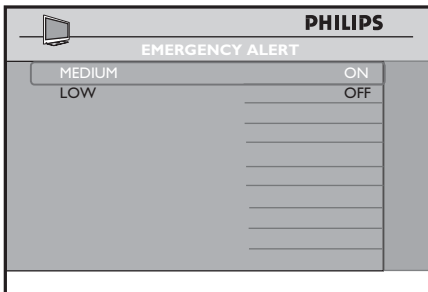

- Select **ON** option to enable **EMERGENCY ALERT**.
Note : **HIGH** Emergency Alert cannot be disabled

I. Selecting and Configuring the settings and options

In the **CONFIGURATION** menu, it allows you to select and configure the settings and options for :

1. Switch On / OSD
2. Picture / Sound
3. Security
4. Control
5. Video Adjustment
6. Features
7. CC / V - CHIP

- Press the > button to enter the **CONFIGURATION** menu.

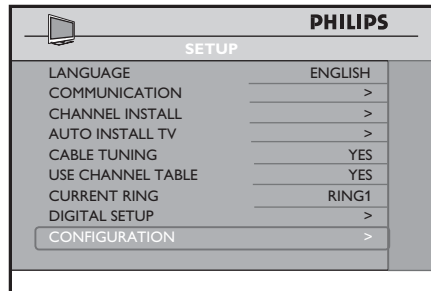

- Press the ^ v buttons to select the item you want to configure.

Installation

1. Specifying the configurations when switching on TV

In the **SWITCH ON / OSD** menu, it allows you to select and configure the settings and options for :

- Welcome Message
- Switch on Channel
- Switch on Volume
- Switch on Picture Format
- Power On
- Volume Indicator
- Channel Display

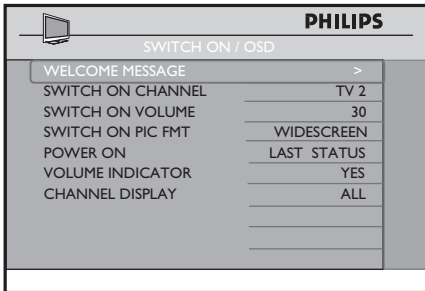

You can choose to:

- key in a welcome message.
- set a channel which you desire the TV to always tune to at startup.
- specify the volume setting at startup.
- select your preferred picture format at startup (4:3, Zoom 14:9, Stretch 4:3, Zoom 16:9, Subtitle Zoom, Wide screen, Super zoom or Full screen).
- select the status (Last Status, On, Standby or Forced On) of the TV when powered on. **If FORCED ON** option is selected, the POWER buttons on the Guest Remote Control and the TV will be disabled.
- display the volume indicator.
- display the channel number or label (if any) or both.

2. Specifying the configurations for TV PICTURE / SOUND

You can select and configure the settings and options for **Brightness, Color, Contrast, Sharpness, Tint, Active Control, Treble, Bass, Balance and AVL**

- Press the > button to enter the **PICTURE / SOUND** menu.

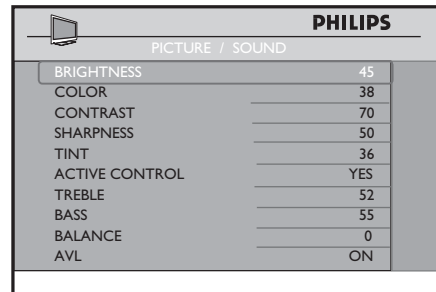
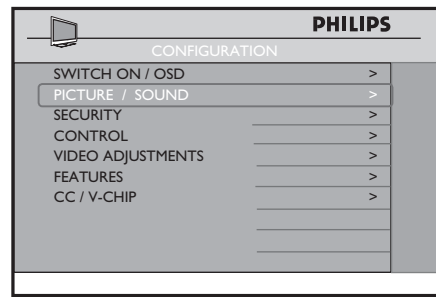

- Press the ^ v buttons to select the item you want to configure.
- Press the < > buttons to make adjustments or select option.

Installation

3. Specifying the Security options

In the **SECURITY** menu, you can select the option to enable access to the **SETUP** menu without a RC2573GR setup remote control.

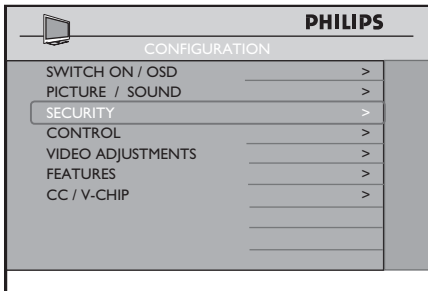

- Press the > button to enter the **SECURITY** menu.

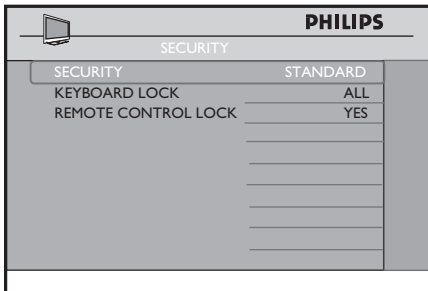

- Press the ^ v buttons to select the item you want to configure.
- If **STANDARD** option is selected in the **SECURITY** menu, the **TV SETUP** menu can be accessed by entering a special security code with a guest remote control.
“Contact the Philips Commercial Solutions Customer Care Center at +1 866 497-4225 should you require further assistance.
- If **HIGH** is selected, the TV setup menu can be accessed only with an a RC2573GR setup remote control in setup mode.

Note :The default security setting is **STANDARD**. When security setting is in **STANDARD** mode, it may be vulnerable to unauthorized operations.

- In the **KEYBOARD LOCK** option, select **YES** to lock the TV keyboard buttons except for the **POWER** button. Select **ALL** to lock all the TV keyboard buttons

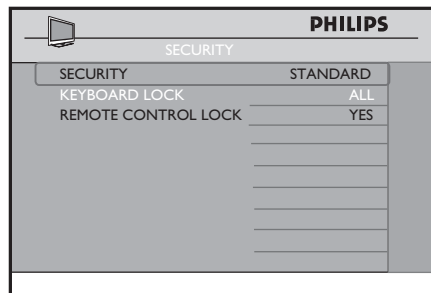

- In the **REMOTE CONTROL LOCK** option, select **YES** to lock all the guest remote control buttons. This feature is particularly suited for TVs that are used in public areas to prevent guests with a remote from changing the station settings in the TV.

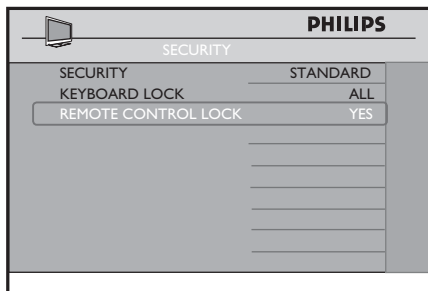

Installation

4. Configuring the Control options

The **CONTROL** menu allows you to select and configure the settings and options for :

- ESP (Energy Saving Programmability)
- Digit Timeout
- 3 Digit Entry
- Source Menu Item
- Channel Guide
- Minimum Volume
- Maximum Volume
- Press the > button to enter the **CONTROL** menu.

- The **ESP** (Energy Saving Programmability) option allows you to select a specified period of time (from 1 HR / 2 HR / 99 HR) to power down your TV automatically. If it does not receive any commands during this period from the remote control or the TV keyboard, this energy saving feature will take effect.

Note : If a remote or keyboard command is received before the ESP time period expires, the Timer will reset and begin counting down again.

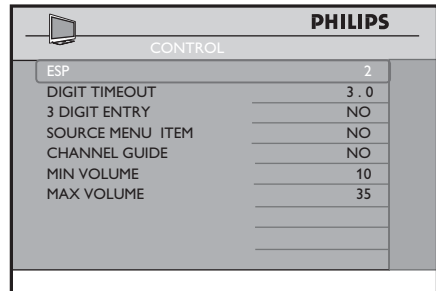
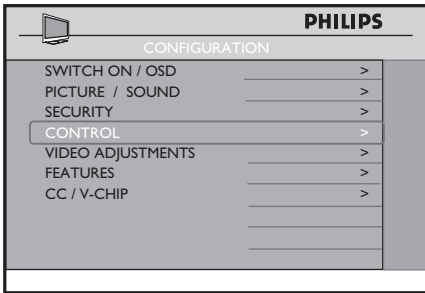

- Press the ^ v buttons to select the item you want to configure.

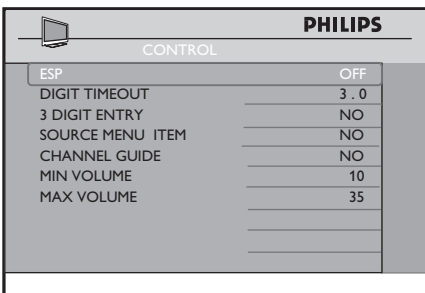

- The **DIGIT TIMEOUT** option allows you to specify a time period (from 1 second to 9.9 seconds) for the channel to switch to another channel when you key in the channel number. It is advisable not to specify too short a time period especially when you want to key in 2 digit channel number. For example, if you specify a 1 second time period, you may not have enough time to key the second digit as the channel will switch after you key in the first digit.

Note : The recommended and default setting is 3.0 seconds.

Installation

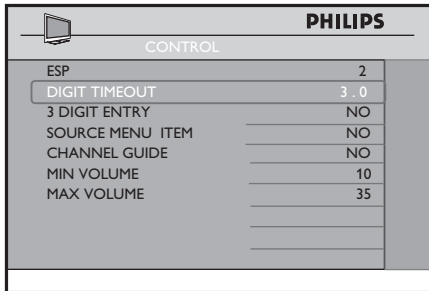

- In the **3 DIGIT ENTRY** option, select **YES** to enable channel selection of 1 to 250 for cable mode and 2 to 250 for antenna mode. Select **NO** enable channel selection of 1 to 99 for cable mode and 2 to 99 for antenna mode.

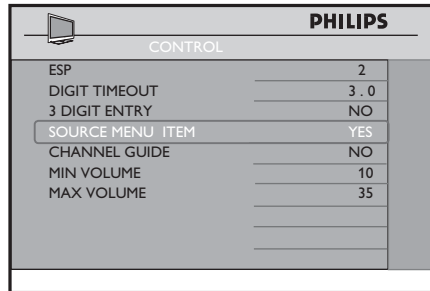

- The **CHANNEL GUIDE** is an on-screen guide of channels that can be used for displaying the channels programmed into the TV. The guide will only function for channels you have labeled (see page 18 “Naming a Channel”). This feature is useful for showing your guests where channels or inputs are mapped and is usually not used in a PPV system as the PPV system has its own map and guide.
- In the **CHANNEL GUIDE** option, select **YES** to enable the Channel Guide.

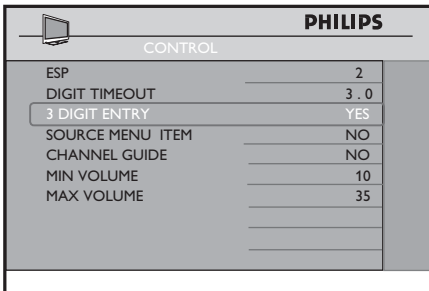

- The **SOURCE MENU ITEM** option allows you to remove Source from the options menu the guest can see. The guest will not have access to any inputs not mapped to a channel in this case.
- If **YES** is selected, the Source line item will appear in the options menu. If you select **NO**, the Source line item will not appear.

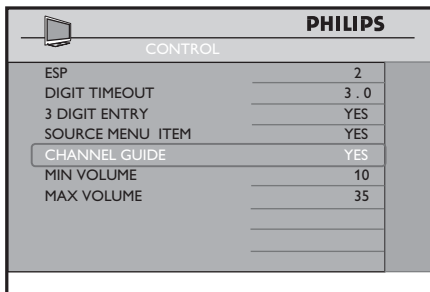

- The **MIN** and **MAX VOLUME** options allows you to specify the limit setting for Minimum and Maximum Volume.

Installation

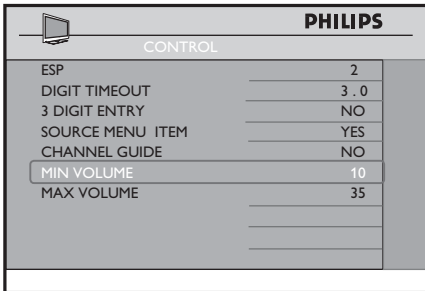

5. Adjusting the Picture horizontally and vertically

The **VIDEO ADJUSTMENTS** options allows you to adjust the picture horizontally and vertically. This is useful for configuring channels that have tickers or scrolling banners at the bottom such as news and sports channels.

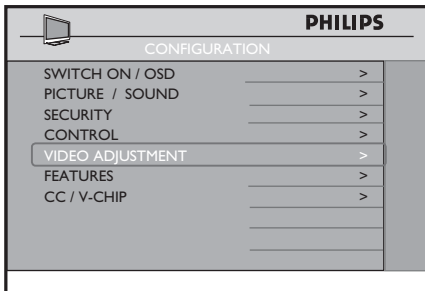

- Press the > button to enter the **VIDEO ADJUSTMENT** menu.

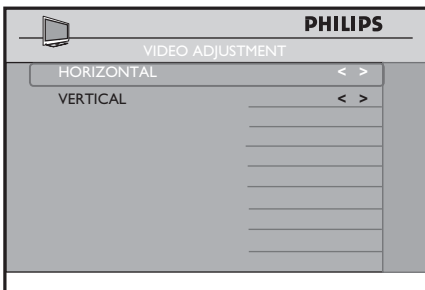

- Press the \wedge \vee buttons to select the item you want to configure.
- Press the < > buttons to make adjustments.

6. Configuring the Features options and settings

- Press the > button to enter the **FEATURES** menu. In the **FEATURES** menu, you may select and configure the settings and options for:
 - Smartpower
 - Smart Sound Key
 - Default HDMI Audio
 - Low Power Standby
 - Loud Speaker Mute

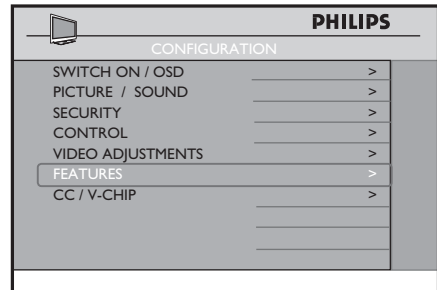

- Press the \wedge \vee buttons to select the item you want to configure.
- Press the < > buttons to select options.

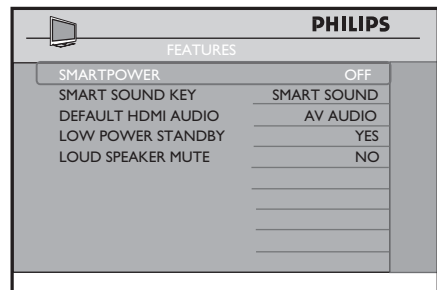

Installation

- The **SMARTPOWER** option allows you to put the TV in an energy saving mode which can save up to 30% in energy consumption costs.
- Select from **LOW, MEDIUM** or **HIGH** to activate energy saving mode.

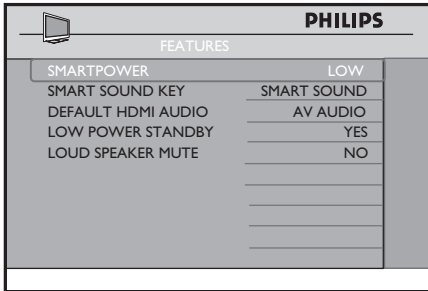

- In the **SMART SOUND KEY** option, select **AUDIO SELECT** to allow you to configure the Smart Sound button on the Guest remote control to toggle the different audio sources and smart sound settings.

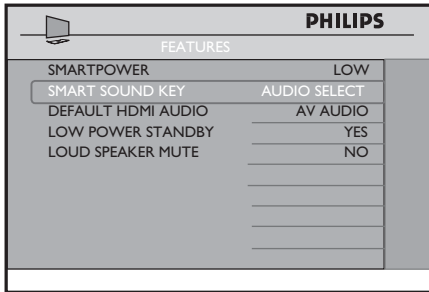

- Select **SMART SOUND** to listen to different **SMART SOUND** modes.

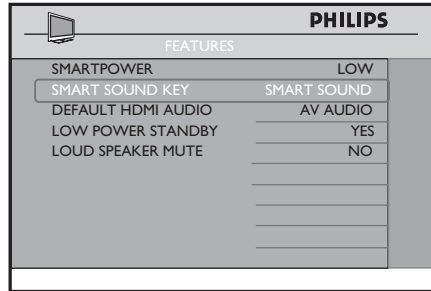

- The **DEFAULT HDMI AUDIO** option allows you to select the HDMI Audio from different Sources. This feature is particularly useful for connecting DVI sources to this television. DVI Video can convert easily to HDMI with a simple adaptor, but the audio signal is not present and must then be connected to one of the other inputs on the TV. This feature allows you to match the DVI video to the Audio signal you have connected.

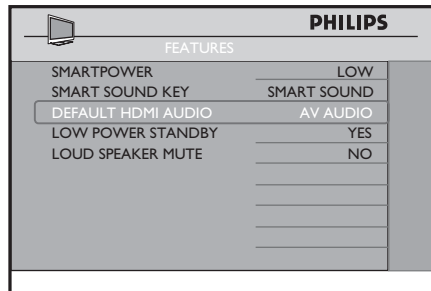

- By default, the **LOW POWER STANDBY** option is set to **YES**. If an interactive SmartCard is used with the TV, set the **LOW POWER STANDBY** option to **NO**.

Installation

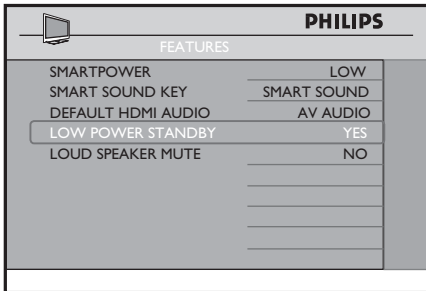

- In the **LOUD SPEAKER MUTE** option, select **YES** to mute the TV speakers permanently.

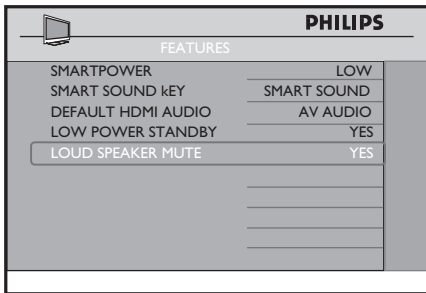

7. Configuring the CC / V-CHIP options and settings

The **CC / V-CHIP** menu allows you to select and configure the settings and options for :

- Save CC
- CC
- Saved V-CHIP
- V-CHIP Menu Item
- V-CHIP SETUP

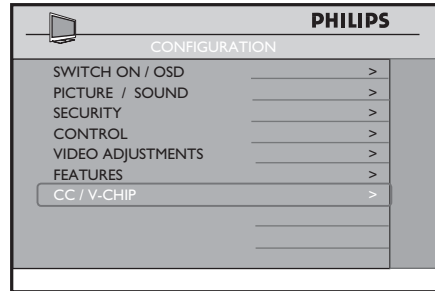

- The **SAVE CC** option allows the TV to remain in whatever CC mode the last guest selected, rather than returning to the default setting you specify in the next step.

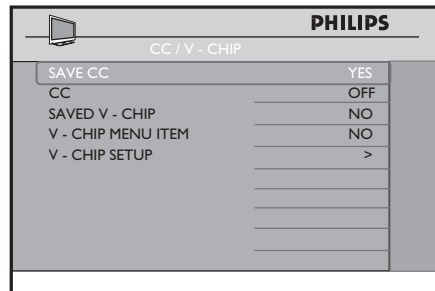

- This is the default CC mode. As long as **SAVE CC** is set to **OFF** the TV will always power up with CC in the mode specified here. Options are **ON**, **OFF** and **ON MUTE**.

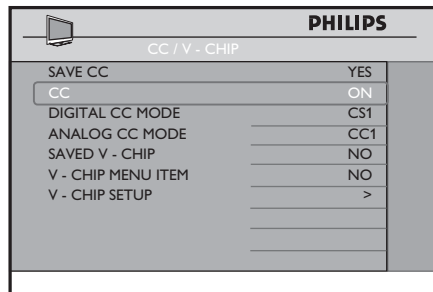

Installation

- The **DIGITAL CC MODE** option allows you to set your digital CC options from **CS1** to **CS6**. In the **ANALOG CC MODE** option, it allows you to set your analog CC options from **CC 1** to **CC 4** and **TXT 1** to **TXT 4**.

Note : If Digital CC option that was selected is not available in the current digital channel, the TV will switch to Analog CC mode.

- Go to the **SAVE V-CHIP** option and select **YES** to allow the guest to save all the V-CHIP settings.

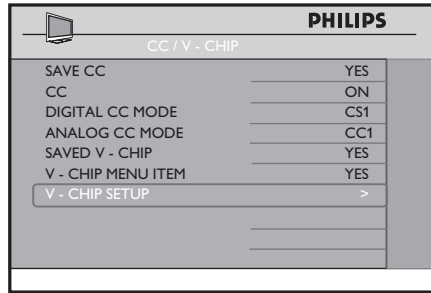
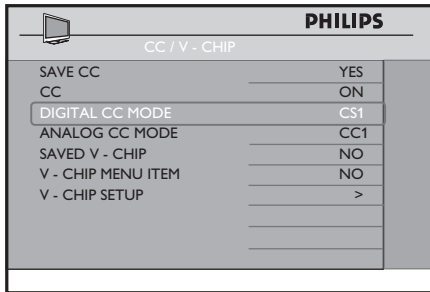

- In the **V-CHIP MENU ITEM** option, select **YES** to allow the guest to change all the V-CHIP settings.

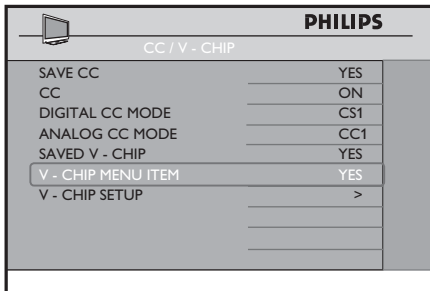

- In the **V-CHIP SETUP** option, proceed to change the V-CHIP settings.

Definitions, Acronyms and Abbreviations

APAC	Automatic Pixel Aging Correction. A technique whereby the image displayed on the television screen is periodically shifted slightly, for the purpose of minimizing plasma panel phosphor “burn-in”.
A/V	Audio / video.
BDS	Business Display Solutions. See PBS.
Bit Rate	Sometimes written “bitrate”, the frequency at which bits are passing a given (physical or metaphorical) “point”, quantified in terms of bits per second (bit/s).
CVI	Component video input. Sometimes used interchangeably with “YPbPr”.
CVBS	Composite Video Broadcast Standard. Video signal containing combined color, luminance, and synchronization signals. Also often referred to as “AUX” video.
DB-9	Standardized 9-pin connector, typically used for RS-232 asynchronous serial communications.
DB-15	Standardized 15-pin connector, typically used for VGA/ computer display signals.
DCM	Data Communications Module. ITV terminology for devices that communicate with Philips Institutional Television products by means of the Philips ITV SmartPort.
DFU	Directions For Use. Philips Consumer Electronics term for product instruction documentation.
DHCP	Dynamic Host Configuration Protocol. A protocol used on TCP/IP networks. Allows client configuration (TCP/IP address, default gateway, DNS configuration, etc.) to be sent to clients.
DNS	The network service used in TCP/IP networks that translates host names to IP addresses.
DVI	Digital Visual Interface, a digital interface standard created by the Digital Display Working Group (DDWG) to convert analog signals into digital signals to accommodate both analog and digital monitors.
HTML	Hypertext Markup Language. The set of markup symbols or codes inserted in a file intended for display on a World Wide Web browser page.
IR	Infrared, long-wavelength light energy invisible to the human eye. In this context as applied to wireless remote controls.
IR-FACE	ITV interface module that adds ITV features and connectivity to non-ITV televisions.
MP3	A compressed digital audio format. MPEG (Motion Pictures Experts Group) Layer 3 Audio compression.

Definitions, Acronyms and Abbreviations

MPEG	Moving Picture Experts Group. General term for a range of audio and video compression, and the name of the standards organization for digital video and digital audio compression. Operates under the auspices of the International Organisation for Standardization (ISO).
ITV	Institutional Television. See PBS. Commercial / non-consumer division of Philips Consumer Electronics Co.
NA	Not available, not applicable.
NC	Not connected, no connection.
Off	See “Stand-by”.
On	A state of operation in which the unit (television) is connected to an AC power source, in active use, and capable of responding to queries or commands from a control device (IR remote control) and/or DCM.
OSD	On-Screen Display. The display of alphanumeric text that appears over the video image. Typically generated by a character generator usually integrated into the television chassis control processor.
PBS	Philips Business Solutions. A commercial / non-consumer division of Philips Consumer Electronics. Co., of which Philips BDS, Business Display Solutions, formerly known as ITV, is a part.
Plug	Connector on a cable that connects to a plug.
PPV	Pay Per View.
RC	Remote control.
RC-5, RC-6	Philips IR remote control communication protocol.
RJ-11	Registered jack 11. Modular telephone-style connector form factor with 4 electrical conductors.
RJ-12	Registered jack 12. Modular telephone-style connector form factor with 6 electrical conductors.
Router	Technically, also known as a Layer 2 Switch. A switching hub that operates at the Data Link Layer (Layer 2), and builds a table of the MAC addresses of all the connected stations.
RTSP	Real-Time Streaming Protocol. Allows control of multimedia streams delivered, for example, via RTP (RFC 3389, Real-time Transport Protocol Payload). Control includes absolute positioning within the media stream, recording and possibly device control.

Definitions, Acronyms and Abbreviations

RTP	Real-time Transport Protocol. Defines a standardized packet format for delivering audio and video over the Internet.
Setup Mode	See System 7. Remote control mode used to configure Philips Institutional Televisions for specialized and/or restricted features such as front panel lockout, volume range, channel list, etc..
SmartPort™	Philips proprietary three-wire synchronous serial communications and control interface.
SmartPlug™	See SmartPort.
Socket	Connector on a cable that connects to socket.
SBB	Set-back box. Used interchangeably with “set-top box”. General term for a device that adds functionality to, and / or interfaces a television with, a host content- and/or control- environment.
STB	Set-top box. See SBB.
Stand by	Generally referred to as “off”. A state of operation, characterized by relatively low power consumption, in which the unit (television) is connected to an AC power source, but not in active use, and capable of responding to queries or commands from a control device and/or DCM.
System 0	First data word of a Philips RC-5 / RC-6 remote control code for standard television commands. Synonymous with Business Display Solutions / ITV “guest” mode.
System 7	First data word of a Philips RC-5 / RC-6 remote control code reserved for specialized commands. Used for Business Display Solutions / ITV “setup” mode.
TCP	Transmission Control Protocol / Internet Protocol. De facto standard protocol for Internet communications.
UDP	User Datagram Protocol. A minimal message-oriented transport layer protocol that is currently documented in IETF RFC 768. Used by Philips NetLink to issue device discovery packets.
YPbPr	Component video signals consisting of luminance, and blue and red components.

USA Limited Warranty

Thank you for purchasing this PHILIPS branded Commercial Television.



All Philips branded commercial televisions are designed and manufactured to high standards and deliver high-quality performance. Within the first year of purchase, this two-year Limited Warranty may entitle you to receive an “Advance Exchange*” model on-site within 72 hours of qualification. Within the second year of purchase, this two-year Limited Warranty may entitle you to receive an “Advance Exchange*” model on-site delivered via Ground Transportation.

Philips’ Commercial Television

For more information on this and more great Philips products visit our web site at:

<http://www.philips.com/hospitality>

Philips F1rst Choice Limited Warranty

One Year 72 hour Advance Exchange* / Two Years Advance Exchange*

WHO IS COVERED?

The original purchaser for end use. You must have a sales receipt or other document showing that you purchased the Product. Please retain and store your Proof of Purchase securely.

WHAT IS COVERED?

Defects in materials and workmanship if a valid claim is received by Philips within the Warranty Period. When the warranty on the purchased product expires, the warranty on all exchanged products (including their parts and service labor) also expires.

WHAT IS THE PERIOD OF COVERAGE?

Two (2) years. For two (2) years from the date of purchase, as evidenced by your proof of purchase, Philips will provide an “Advance Exchange” subject to the terms and conditions herein.

USA Limited Warranty

WHAT WE WILL DO TO CORRECT PROBLEMS?

*For the first year, the defective Product will be exchanged with a new Product (or one that has been renewed to original specifications) and delivered within seventy-two hours of qualification. During the second year, the defective product will be exchanged with one that has been renewed to original specifications and delivered via Ground Transportation. In the event of a failure of multiple units at the same location, Philips reserves the right at its sole discretion to send personnel to the location to determine the cause of the failure and determine the most efficient means of resolving the failure.

WHAT IS EXCLUDED?

- unless otherwise provided for herein, shipping charges to return defective products to Philips.
- unless shipped by Philips, damage to or loss of product during shipment.
- labor charges for installation or setup of the product, adjustment of customer controls on the product, and installation or repair of antenna systems outside of the product.
- product repair and/or part replacement because of accident, misuse, unauthorized repair or other cause not within the control of Philips.
- reception problems caused by signal conditions or PPV, cable, or antenna systems outside the unit. o modifications or adaptations to enable a product to operate in any country other than the country for which it was designed, manufactured, approved
- and/or authorized, or repair of products damaged by such modifications or adaptations.
- modifications or adaptations to enable a product to operate with any PPV system other than the PPV systems for which it was designed, manufactured, approved, and/or authorized, or repair of products damaged by such modifications.
- CONSEQUENTIAL, INCIDENTAL, INDIRECT OR SPECIAL DAMAGES RESULTING FROM THE PRODUCT, INCLUDING BUT NOT LIMITED TO DAMAGES FOR LOST DATA, LOST SOFTWARE, OR LOSS OF USE OF THE PRODUCT. (Some states do not allow the exclusion of such damages, so the above exclusion may not apply to you. This provision also excludes such damages for prerecorded material, whether copyrighted or not copyrighted, among all other potential claims.)
- products on which the model, production or serial number has been altered, deleted, removed or made illegible.
- product sold AS IS or Renewed.

USA Limited Warranty

HOW TO GET WARRANTY SERVICE IN U.S.A., PUERTO RICO OR U.S. VIRGIN ISLANDS? OR WHERE CAN I GET MORE INFORMATION?

Before requesting service, please check your owner's manual as adjustments of the controls discussed there may save you a service call. Also, please prepare the following details so we can solve your problem quickly.

- Philips type number
- Philips serial number
- Purchase date (copy of receipt of purchase may be required)
- Pay Per View Provider (if any)
- High Definition signals offered at property (if any)
- Your proof of purchase indicating: date of purchase, dealer name, model and product serial number.
- The full address to which the swap model should be delivered.

Then, contact Philips' ITV Customer Care Center at: **(866) 497-4225**

(IN U.S.A., PUERTO RICO AND U.S. VIRGIN ISLANDS, ALL IMPLIED WARRANTIES, INCLUDING IMPLIED WARRANTIES OF MERCHANTABILITY AND FITNESS FOR A PARTICULAR PURPOSE, ARE LIMITED IN DURATION TO THE DURATION OF THIS EXPRESS WARRANTY. But, because some states do not allow limitations on how long an implied warranty may last, this limitation may not apply to you.)

This Limited Warranty gives you specific legal rights. You may have other rights which vary from state to state.

WARRANTY SERVICE IN CANADA: While this warranty statement is not valid for Canadian purchases, you may be eligible for warranty service. Please contact Philips Canada at: (888) 292-3430

Just a phone call away

Philips' customer help desks are located worldwide. Within the U.S. you can contact Philips Customer Care Monday-Friday from 8:00 AM-9:00 PM Eastern Time (ET) and on Saturdays from 10:00 AM-5:00 PM ET by using the USA contact phone number listed above. To avoid possible shock hazard, please be sure that the television is unplugged from the electrical outlet before cleaning.

Cleaning and Care

- Do not touch the screen with anything hard as this scratch, mar or damage the screen permanently.
- Do not rub with dust clothes with chemical treatment.
- Do not touch the surface with bare hands or greasy cloth (some cosmetics are detrimental to the screen).
- Unplug the TV before cleaning the screen.
- When the surface becomes dusty, wipe gently with absorbent cotton or other soft materials like chamois soaks. Do not use acetone, toluene and alcohol cleaners because they cause chemical damage.
- Do not use liquid or aerosol cleaners.
- Wipe off saliva or water droplets as soon as possible. Long time contact with the screen causes deformations and color fading.

Environmental Care

- This Philips Institutional Television product and its packaging contain materials that can be recycled and re-used. Specialized companies can recycle your product to increase the amount of reusable materials and minimize the amounts which need to be properly disposed.
- This product might also use batteries which should not be thrown away when depleted, but should be handed in and disposed of as small chemical waste.
- Please find out about the local regulations regarding the disposal of the television, batteries, and packaging materials whenever you replace existing equipment.
- This product consumes energy in the stand-by mode. Energy consumption contributes to air and water pollution. It is advisable to switch off your television overnight instead of leaving it in stand-by mode.

Index

A

Accessing the setup Menu 14
Antenna mode 19
Audio select 28
Automatic channel tuning 19

B

Basic TV connections 8
Before calling service 6

C

Cable mode 19
CC (Closed Caption) 29
Changing channel settings 15
Channel guide 26
Channel install 16
Channel logo 16
Cleaning and care 37
Communication source 15
Configuration 22
Control options 25
Current ring 20

D

Default HDMI audio 28
Definitions, acronyms and abbreviations 31
Digital audio language 21
Digital channel scroll 17
Digital closed caption setup 21
Digital minor channel 17
Digital setup 20
Digit timeout 25

E

Emergency alert 22
Energy saving programmability 25
Environmental Care 37

F

Factory channel reset 21
Features 27

G

Guest remote control keys 12

I

Important safety instructions 2

K

Keyboard lock 24

L

Language selection 15
Loud speaker mute 29
Low power standby 28

M

Maximum volume 26
Minimum volume 26
MPEG Program number 17

N

Naming a channel 18

O

Optional remote controls 11
Overview of TV connectors and controls 10
Overview of TV setup main menu/sub-
menus 13

P

Physical channel 19
Picture and sound 23
Picture format 23

R

RF Channel Number 17

S

Safety information and useful tips 28
Security 24

Selecting input source 16
Smartpower 28
Smart RC 15
Smart sound key 28
Source menu item 26
Switch on/ OSD 23

T

Three digit entry 26

U

U.S.A. limited warranty 34
Use and care of optional remote controls 9

V

V-CHIP menu item 30
V-CHIP setup 30
Video adjustment 27
Virtual channel 19
Selecting input source 16
Smartpower 28
Smart RC 15
Smart sound key 28
Source menu item 26
Switch on/ OSD 23

T

Three digit entry 26

U

U.S.A. limited warranty 34
Use and care of optional remote controls 9

V

V-CHIP menu item 30
V-CHIP setup 30
Video adjustment 27
Virtual channel 19

Dolby Digital



Manufactured under license from Dolby Laboratories. 'Dolby' and the double-D symbol are trademarks of Dolby Laboratories.

Kensington Security Slot



(if present)

Your TV is equipped with a Kensington Security Slot, to prevent it from getting stolen. An anti-theft Kensington lock has to be purchased separately. The Kensington lock is a plastic-coated steel cable with a lock. One end has to be fixed to the opening of the TV and locked with a special key. The other end is attached to a fixed point.

® Kensington and MicroSaver are registered US trademarks of ACCO World Corporation with issued registrations and pending applications in other countries throughout the world. All other registered and unregistered trademarks are the property of their respective owners.







© 2007 Koninklijke Philips N.V.

All rights reserved

Document order number: 3139 125 39171

1 How to use this guide

The purpose of this Quick Start Guide is to assist you in getting this Philips Commercial television installed as quickly as possible. It contains the necessary information needed for most typical connections and installations. For detailed documentation of additional features, please consult the user manual or online help at www.philips.com/hospitality.

Go through this Quick Start Guide and read the instructions on :

- how to do a Stand alone installation
- how to change the settings of a channel
- how to do a Smovie TV™ installation
- how to configure the Volume / Picture and other common settings
- how to clone the TV configuration to a SmartLoader and from the SmartLoader to the TV
- installing a Pay-Per-View SmartCard
- installing a Pay-Per-View Box
- how to diagnose basic problems

2 What you can find in the box

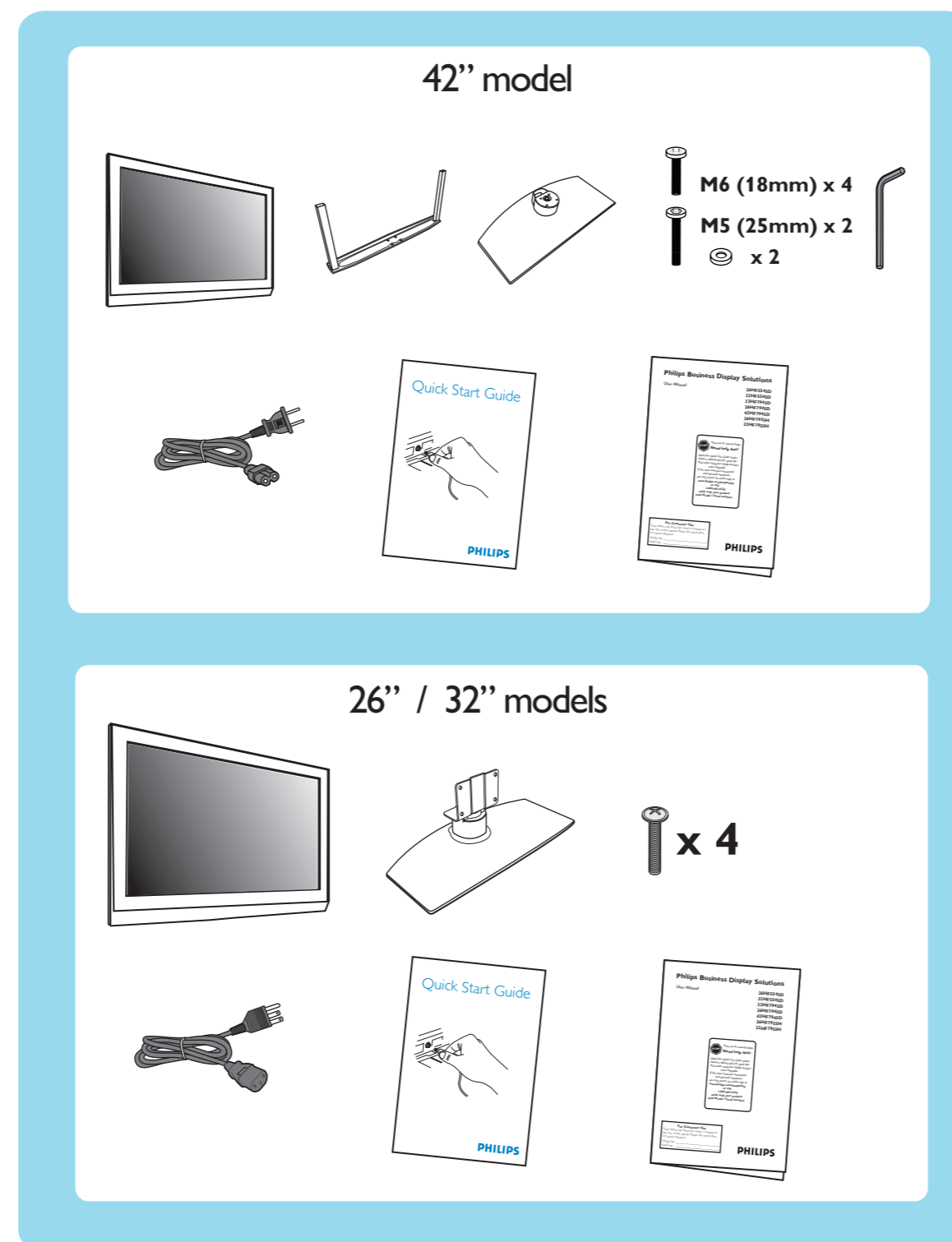

3 Stand alone installation

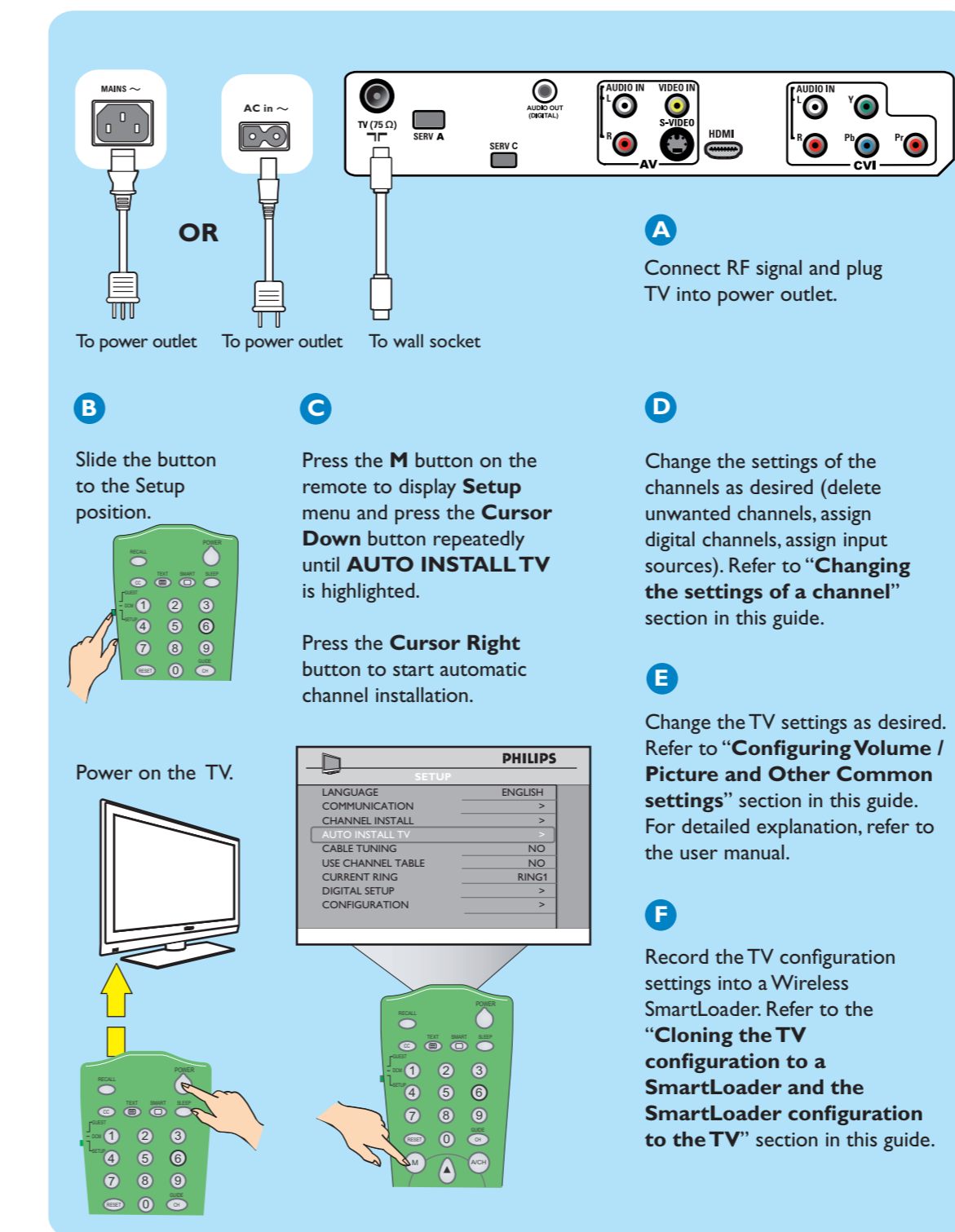

Quick Start Guide

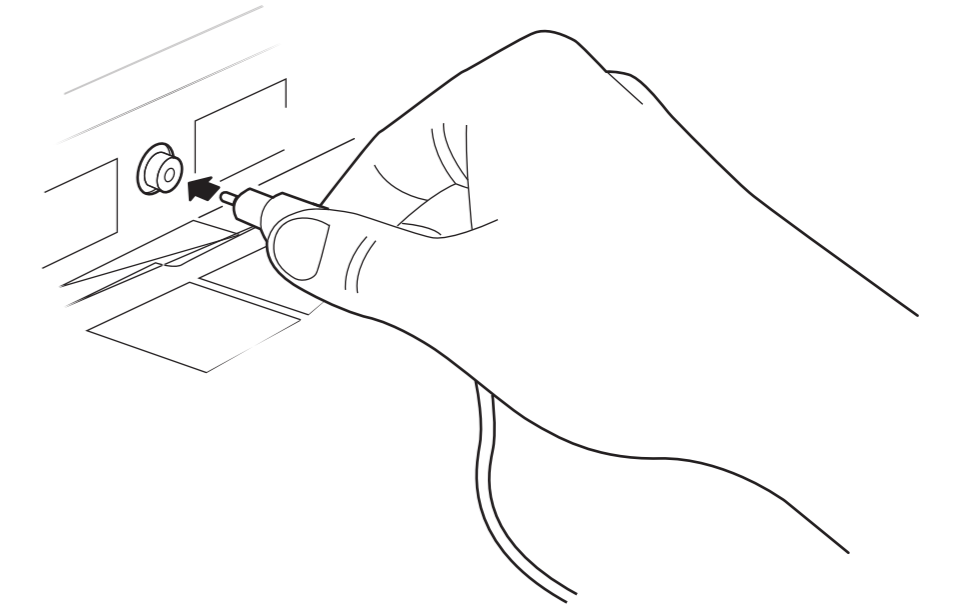

PHILIPS

4 Changing the settings of a channel

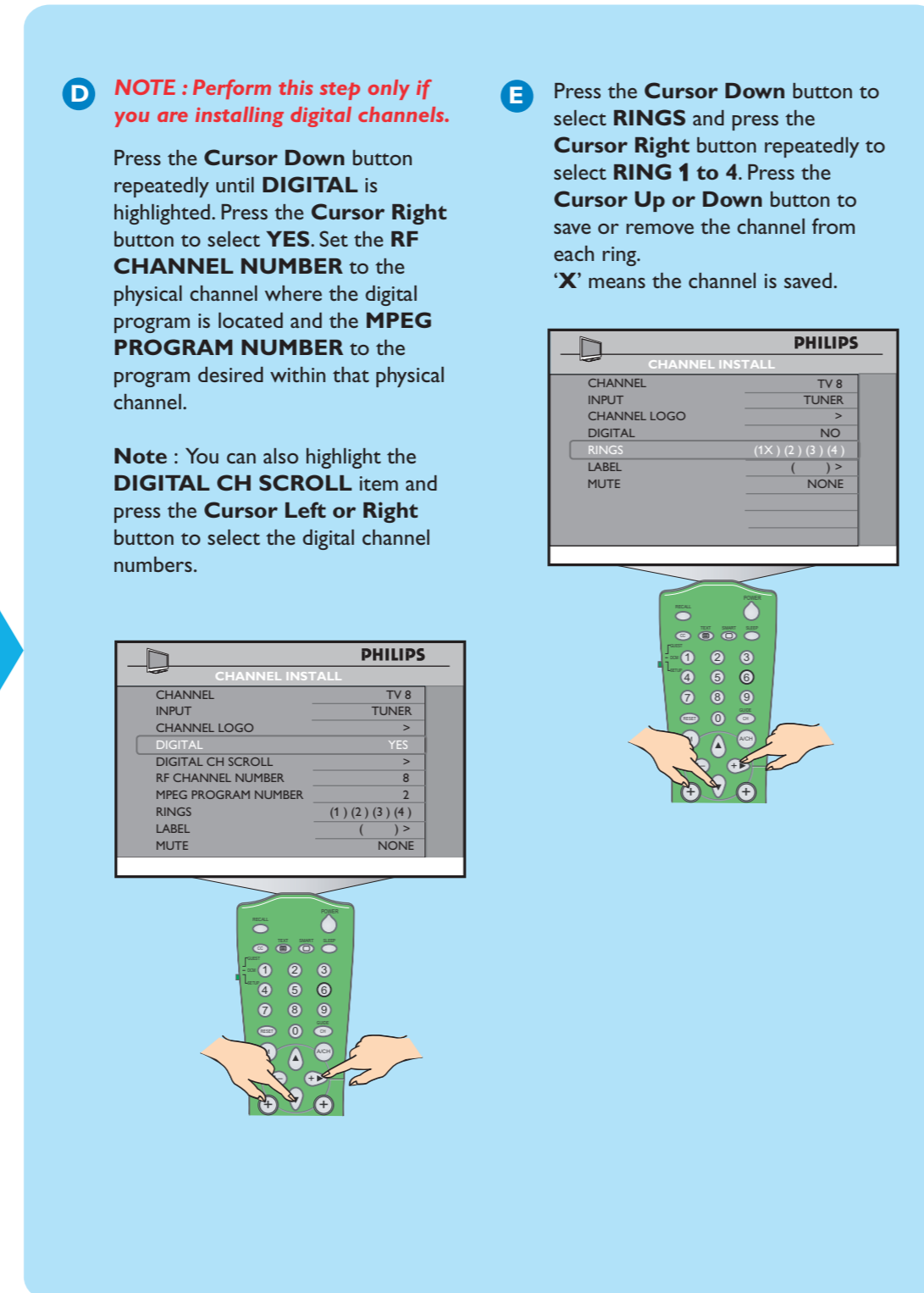
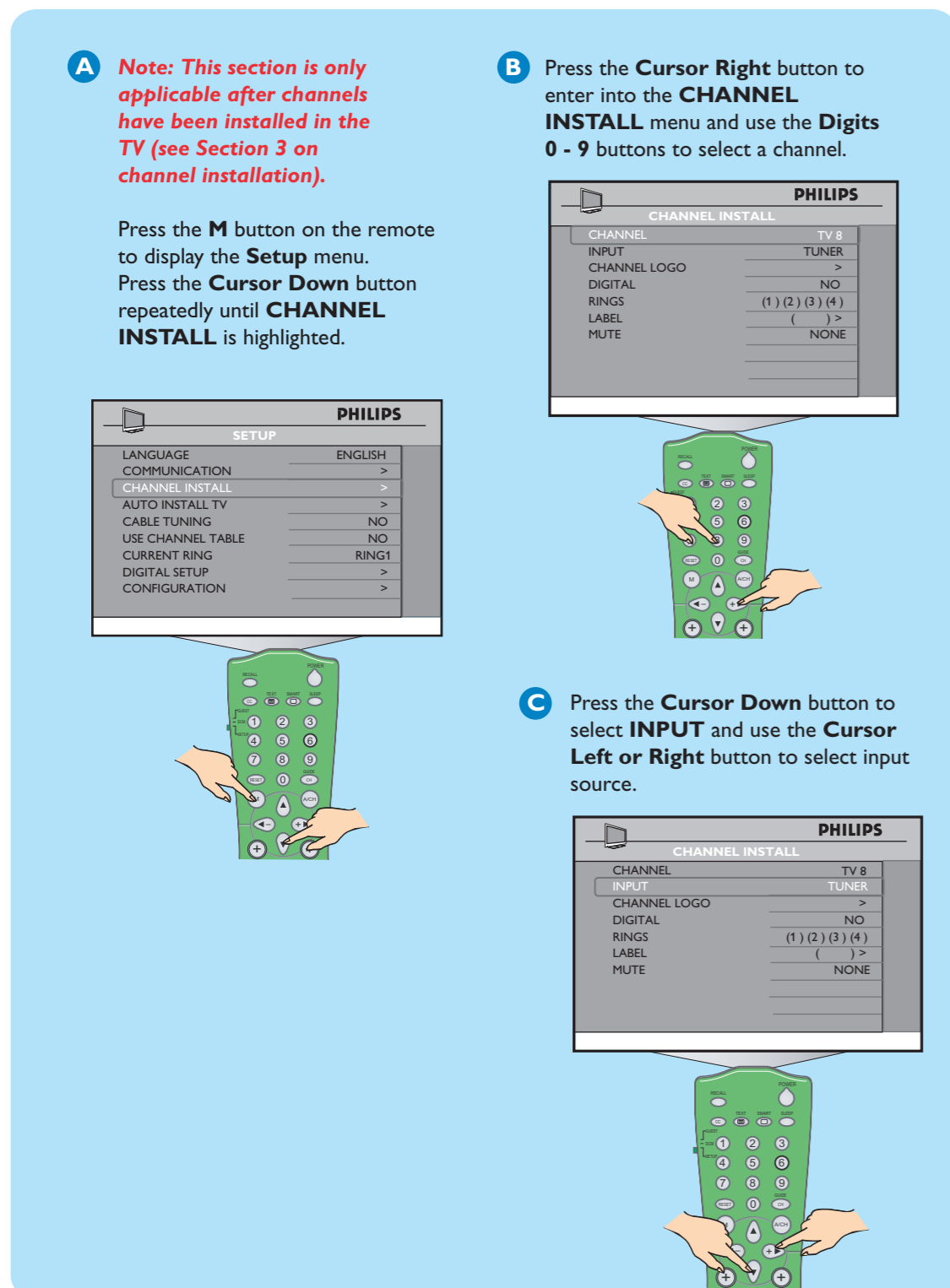

5 Smovie TV™ Installation

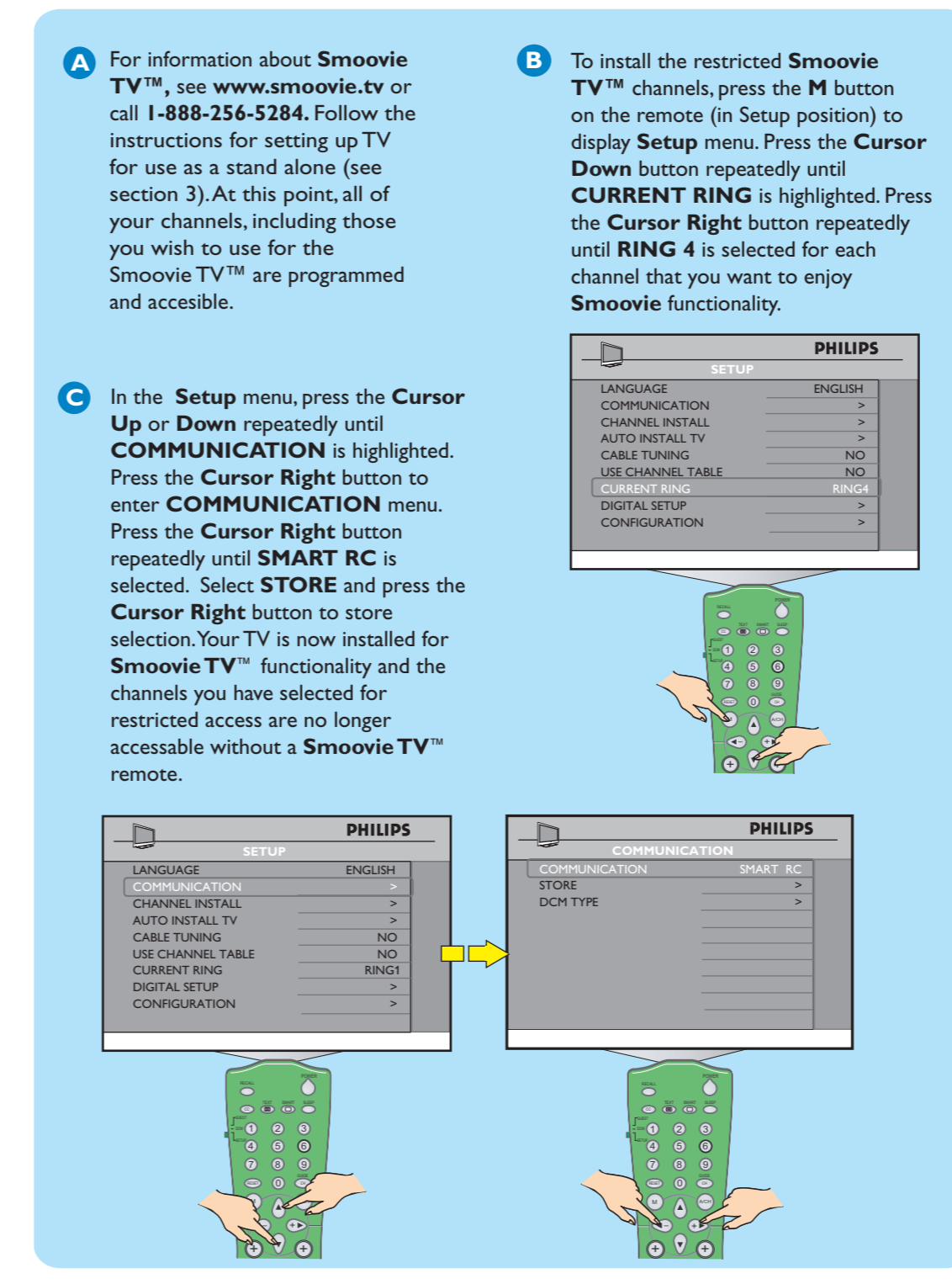

6 Configuring the Volume / Picture and Other Common settings

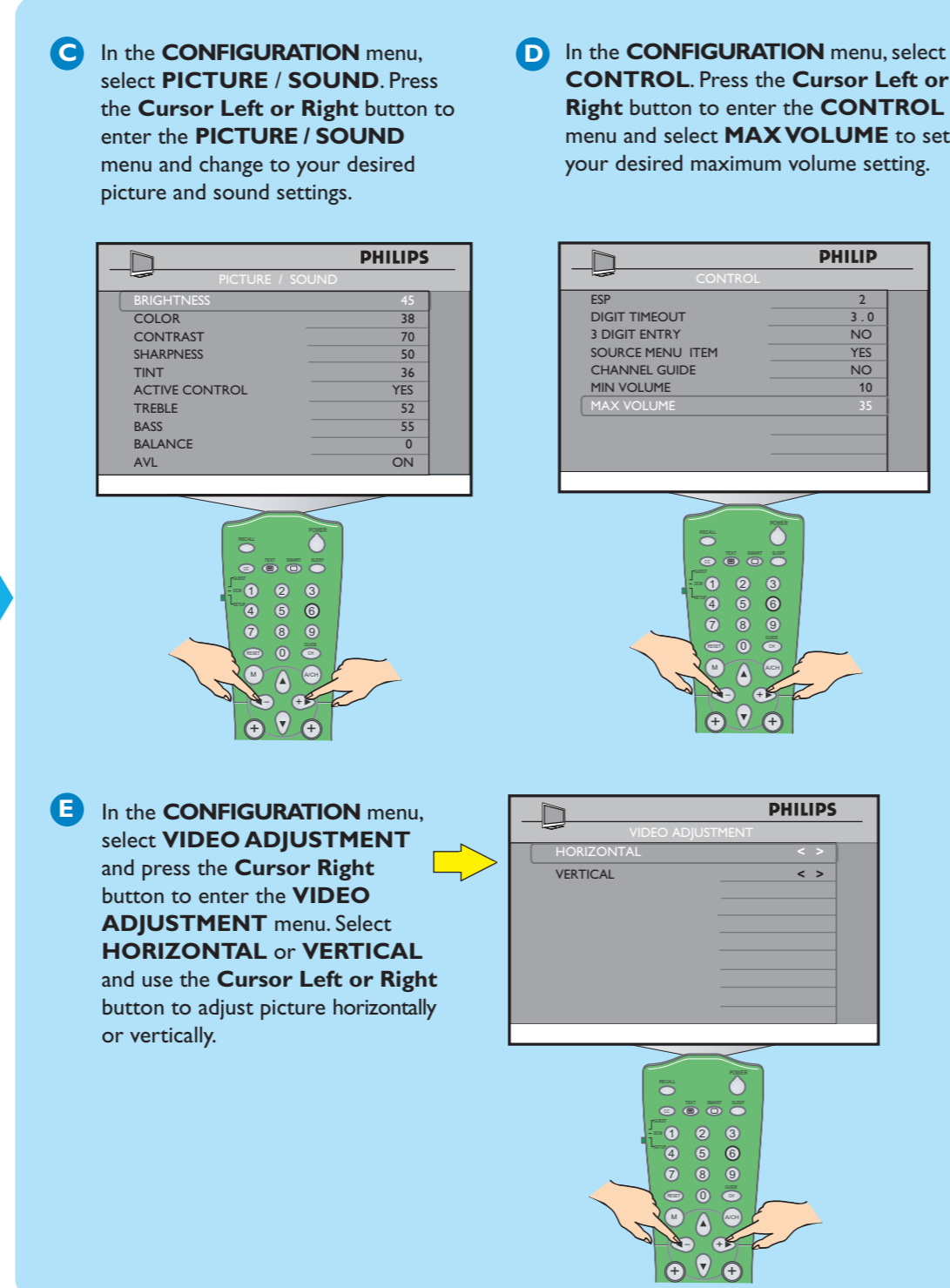
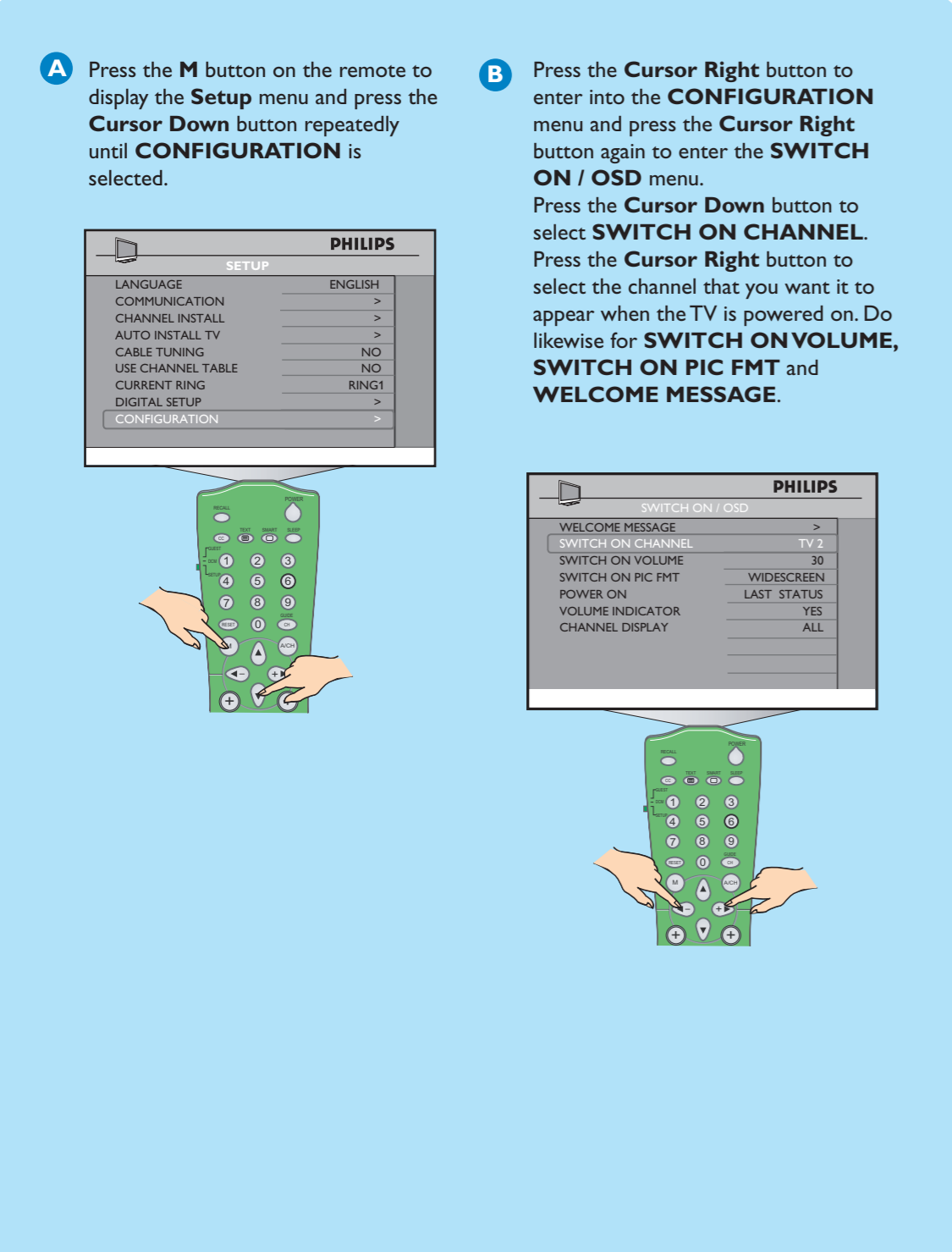

7 Cloning the TV configuration to a SmartLoader and the SmartLoader configuration to the TV

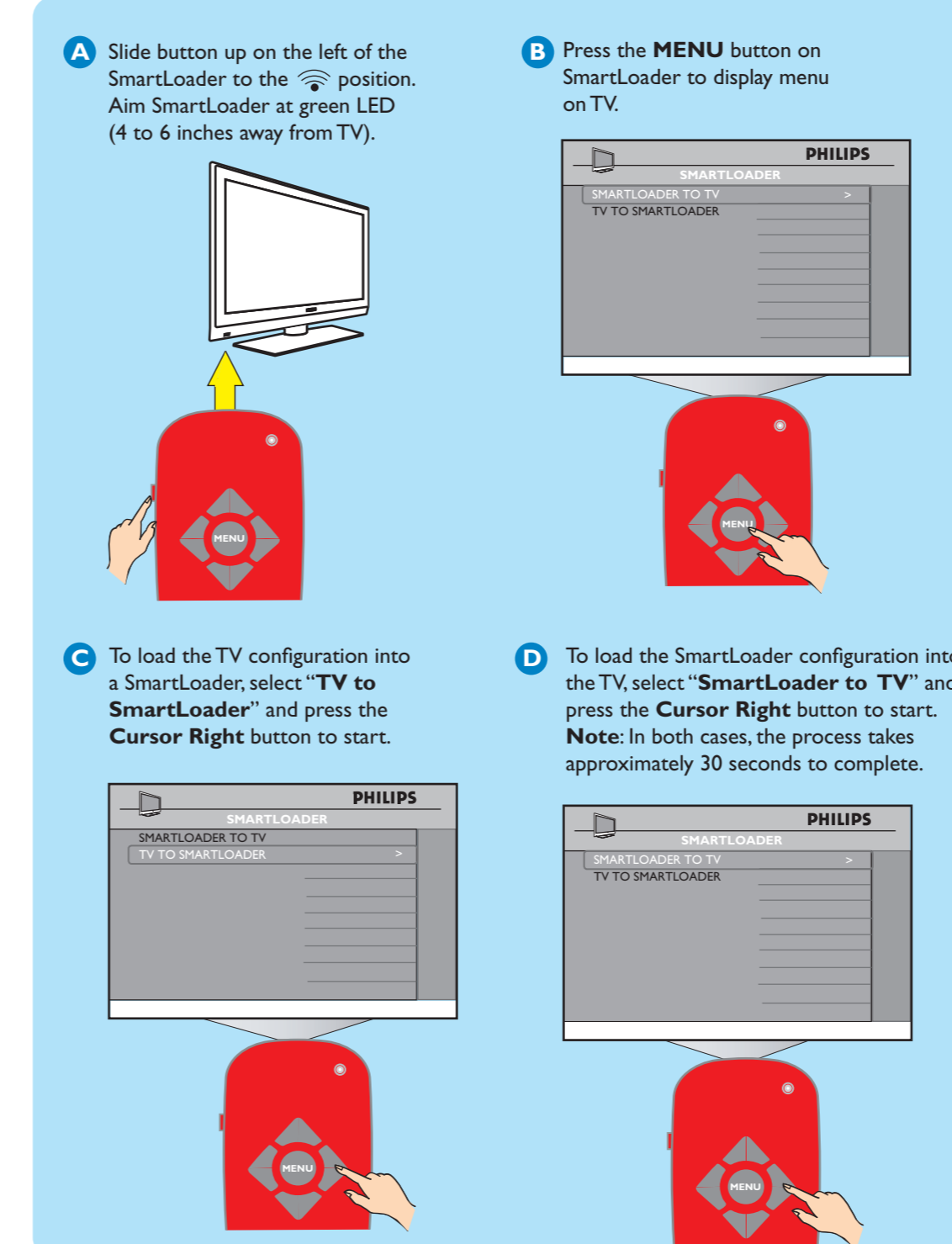

8 Installing a Pay-Per-View SmartCard

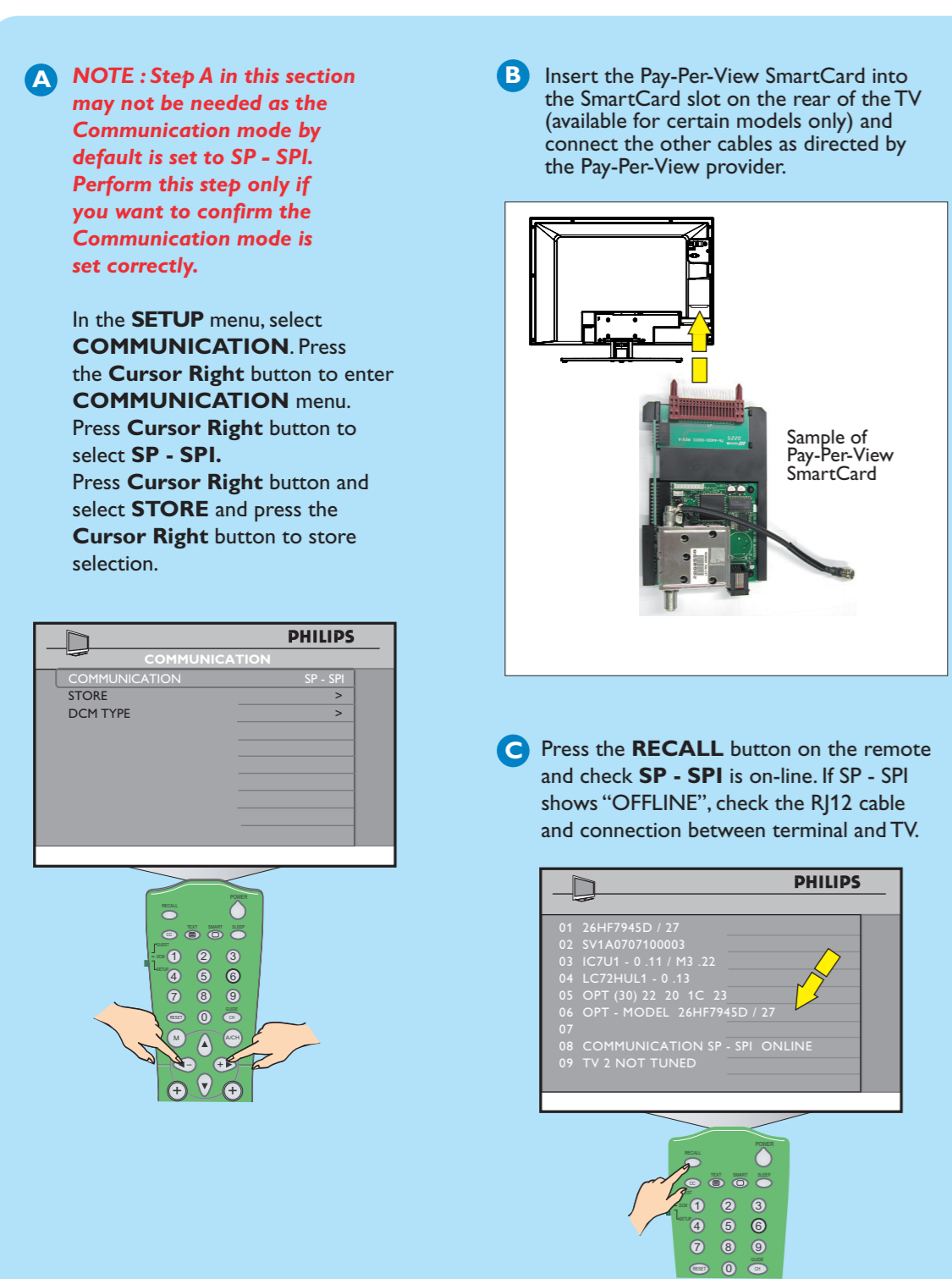

9 Installing a Pay-Per-View Box

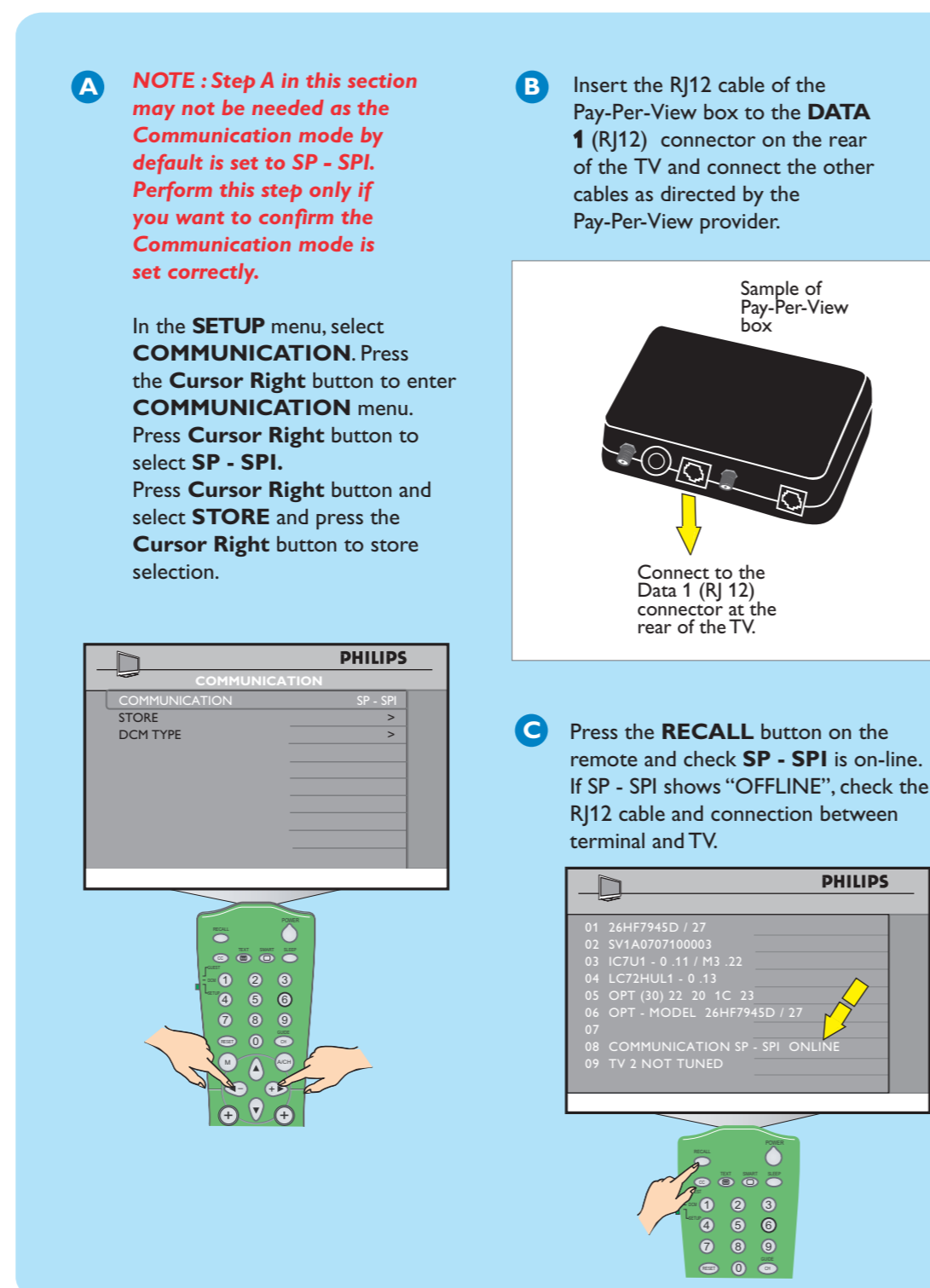

10 Diagnosing Basic Problems

