

PHILIPS

大型顯示器

快速使用指南

7406 / 7466 系列

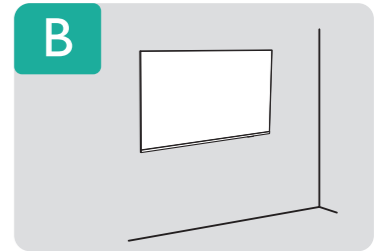
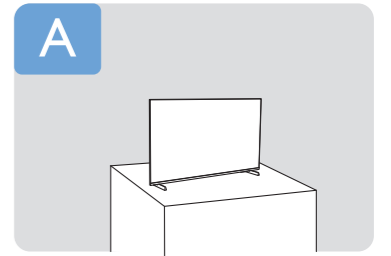
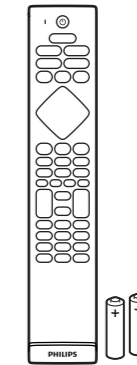
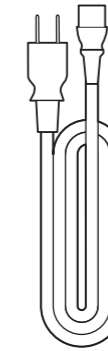
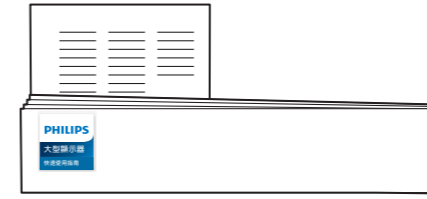
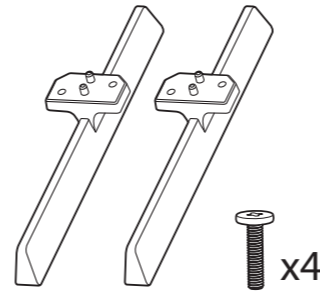
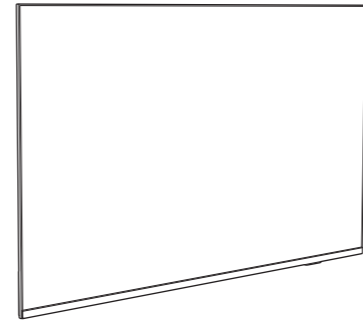

A

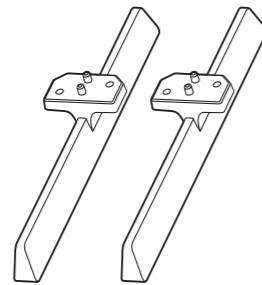
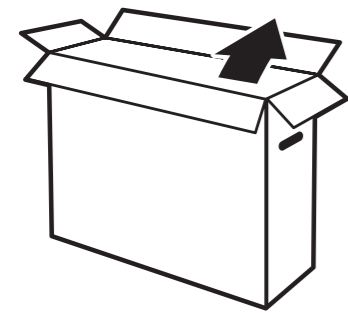

1

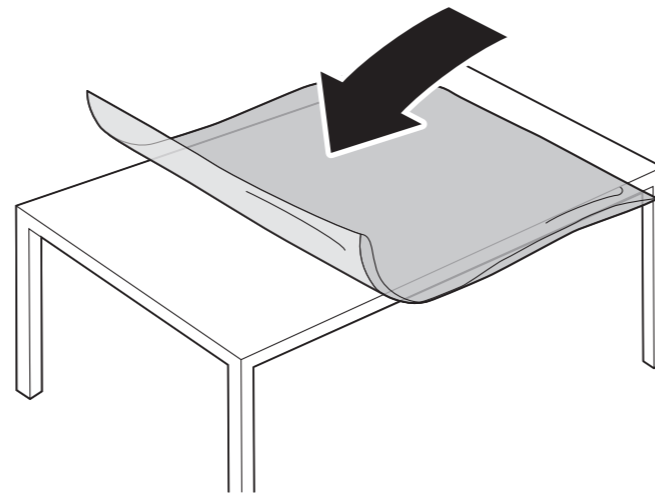

2

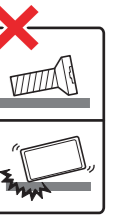
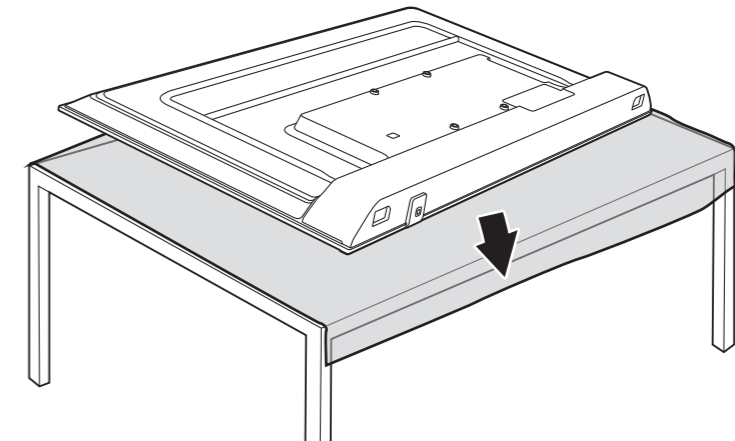

3

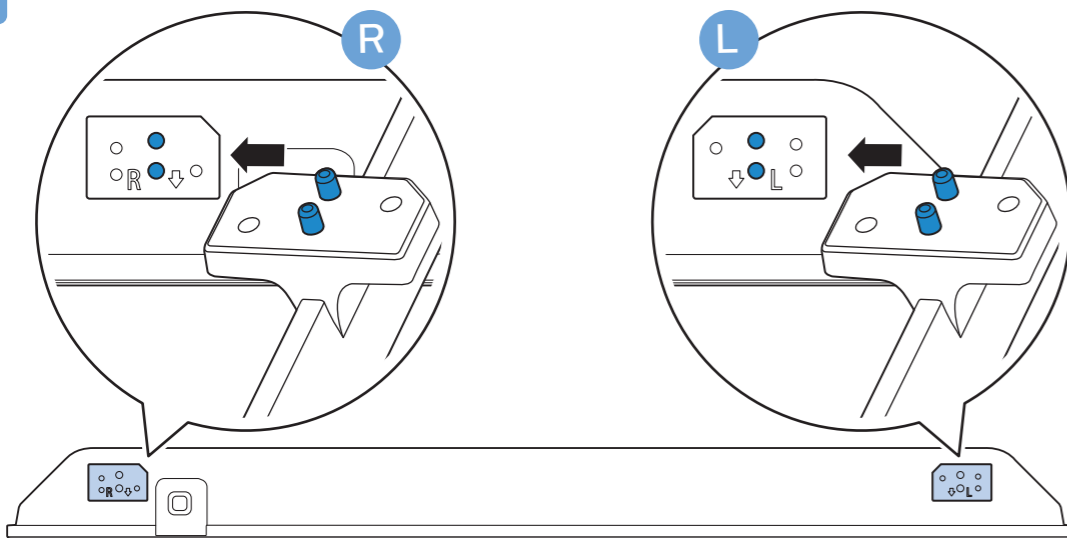

4

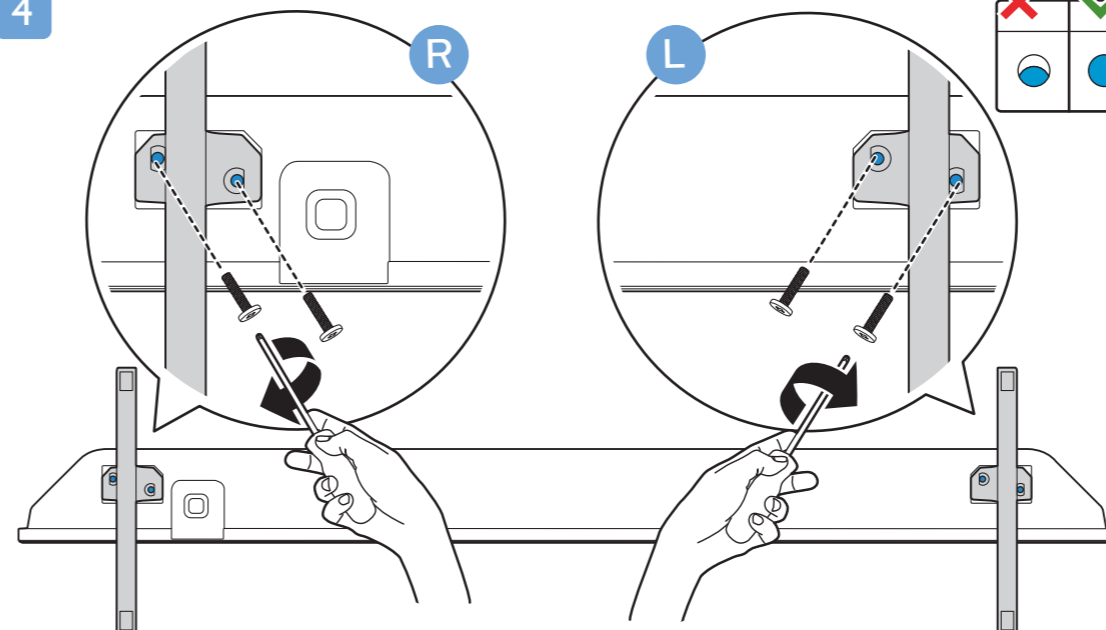

5

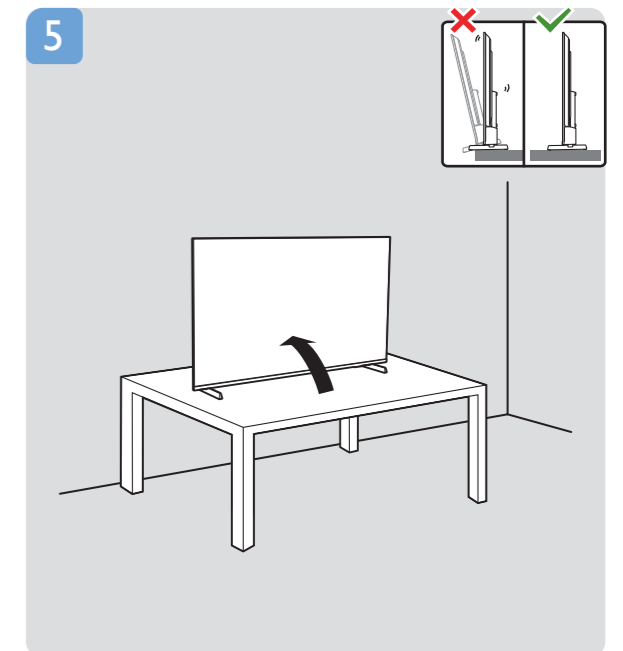

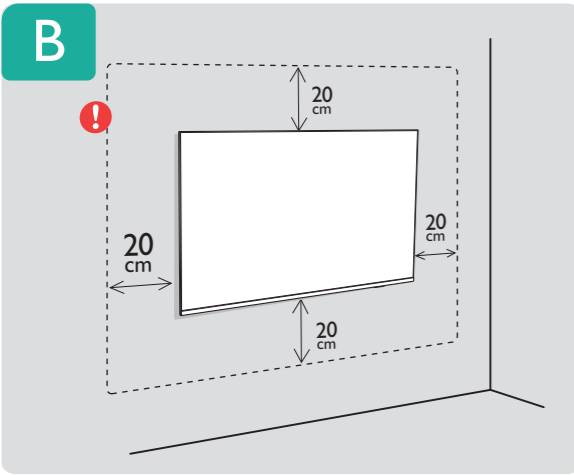

VESA (x,y)

43" 100x200mm M6 (L: 10mm~12mm) 108 cm

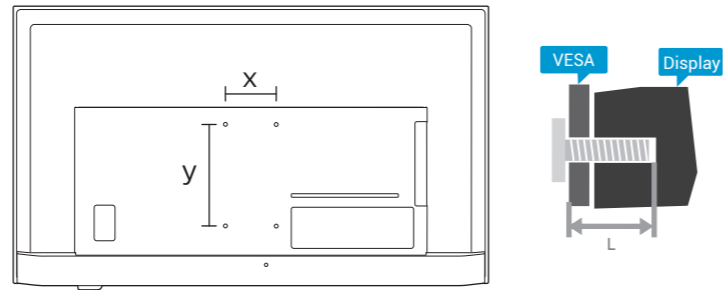

繁體中文 請閱讀安全說明。



此機種無附上紙本使用手冊，請使用以下網址輸入機種型號搜尋後自行下載。

*使用手冊包含限用物質標示說明。

www.philips.com/TVsupport

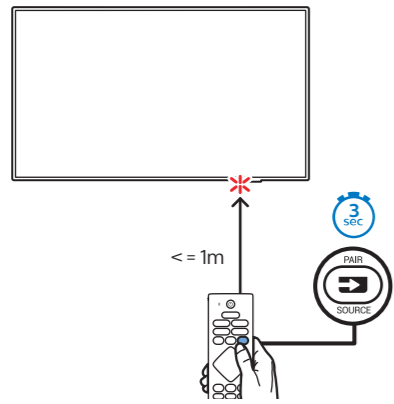
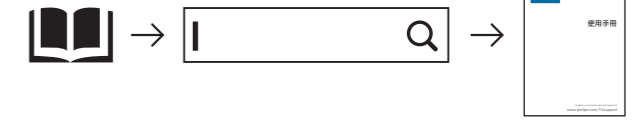

設備名稱：Philips LED背光源智慧型顯示器
型號（型式）：43PUH7406/96, 43PUH7466/96

單元	限用物質及其化學符號					
	鉛 (Pb)	汞 (Hg)	鎘 (Cd)	六價鉻 (Cr ⁺⁶)	多溴聯苯 (PBB)	多溴二苯醚 (PBDE)
塑料外框	○	○	○	○	○	○
後殼	○	○	○	○	○	○
液晶面板	-	○	○	○	○	○
電路板組件	-	○	○	○	○	○
底座	○	○	○	○	○	○
電源線	-	○	○	○	○	○
其他線材	-	○	○	○	○	○
遙控器	-	○	○	○	○	○

備考1. "○" 係指該項限用物質之百分比含量未超出百分比含量基準值。
備考2. "-" 係指該項限用物質為排除項目。

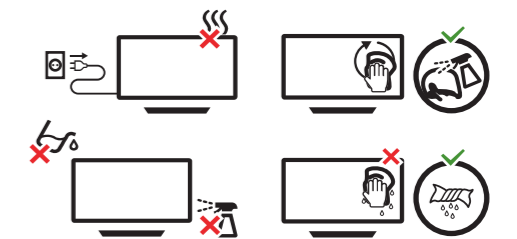
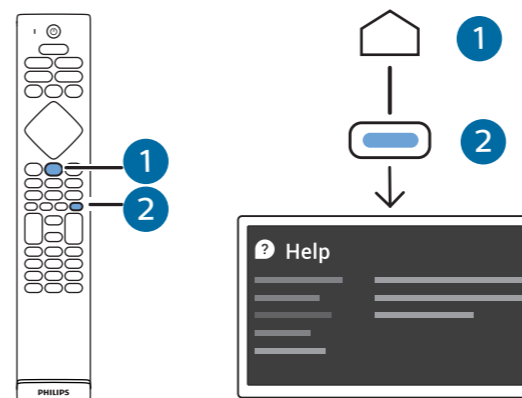
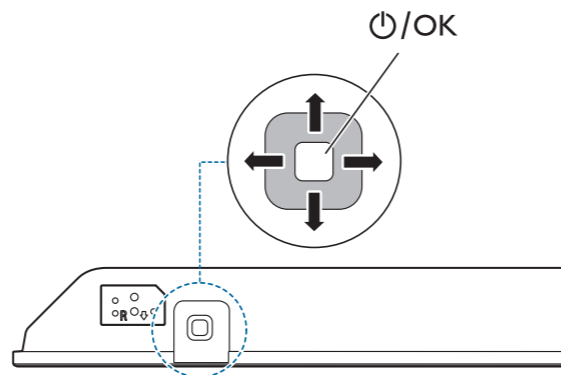
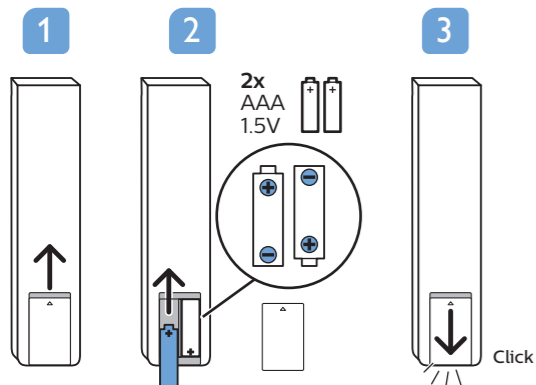
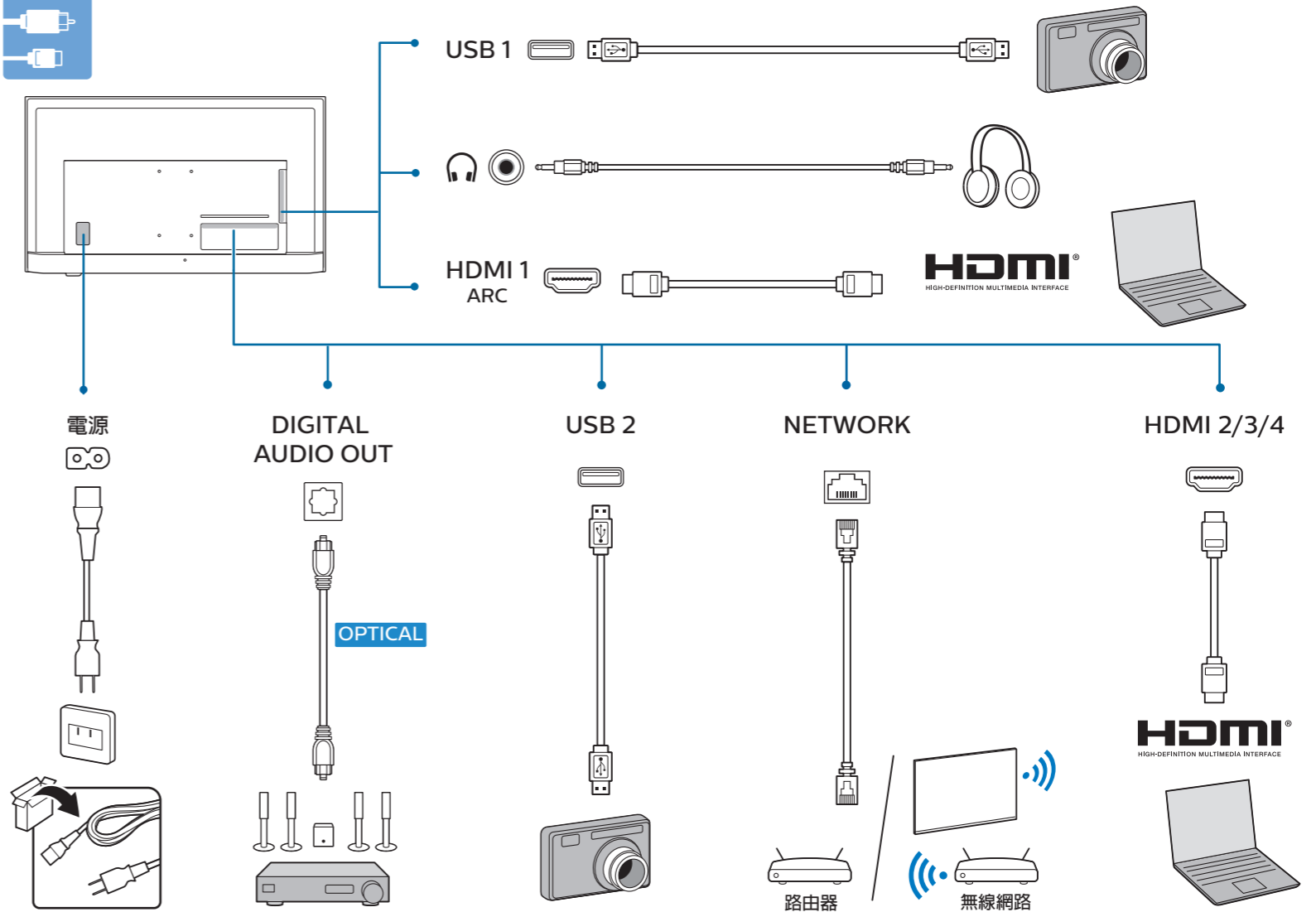
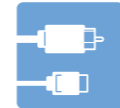
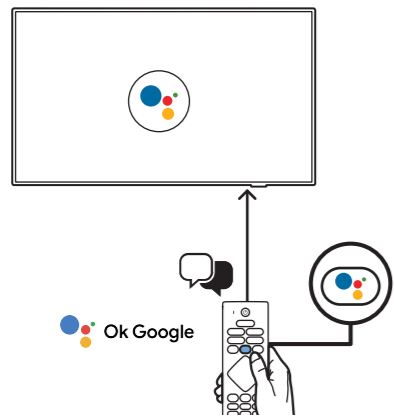

所有註冊和未註冊的商標是其各自所有者的財產。
規格如有變更，恕不另行通知。
Philips 和 Philips 商標圖形是Koninklijke Philips N.V. 的註冊商標。
其使用需獲得Koninklijke Philips N.V. 的許可。
This product has been manufactured by and is sold under the responsibility of TP Vision Europe B.V., and TP Vision Europe B.V. is the warrantor in relation to this product.
©2021 TP Vision Europe B.V. All rights reserved.
www.philips.com/welcome