

Register your product and get support at
www.philips.com/welcome



32PFL3605/77

32PFL3615/77

42PFL3605/77

42PFL3615/77

EN User manual

PHILIPS

INSTRUCCIONES DE SEGURIDAD IMPORTANTE

Lea antes de operar el equipo

1. Lea estas instrucciones.
2. Guarde estas instrucciones.
3. Preste atención a todas las advertencias.
4. Siga todas las instrucciones.
5. No use este aparato cerca del agua.
6. Límpielo solamente con un paño seco.
7. No bloquee ninguno de los orificios de ventilación. Instálelo de acuerdo con las instrucciones de los fabricantes.
8. No lo instale cerca de fuentes de calor, tales como radiadores, compuertas de tiro (registros) de calor, estufas u otros aparatos (incluidos amplificadores) que generen calor.
9. No anule el objetivo de seguridad del enchufe polarizado o de conexión a tierra. Un enchufe polarizado tiene dos paletas, una más ancha que la otra. Un enchufe de conexión a tierra tiene dos paletas y una tercera espiga de conexión a tierra. La paleta más ancha o la tercera espiga es entregada para su seguridad. Si el enchufe suministrado no se ajusta a su tomacorriente, consulte a un electricista para que reemplace el tomacorriente obsoleto.
10. Evite pisar o apretar el cable de suministro eléctrico, especialmente en los enchufes, tomacorrientes y el punto en que salen del aparato.
11. Sólo use aditamentos o accesorios especificados por el fabricante.
12.  Utilice sólo un carro, soporte, trípode, repisa o mesa especificados por el fabricante o que se vendan junto con el aparato. Si usa el carro, tenga precaución cuando mueva la combinación carro/aparato para evitar lesiones si éste se vuelca.
13. Desenchufe este aparato durante las tormentas eléctricas o cuando no se use durante largos períodos.
14. Deje que personal calificado realice todo el servicio. Es necesario que el aparato reciba servicio si se ha dañado en algún modo, como cuando se daña el cable o enchufe de suministro de corriente, se ha derramado líquido u objetos han caído dentro él, cuando el aparato ha estado expuesto a lluvia o humedad, no opera bien o se ha caído.
15. Es posible que este producto contenga plomo y mercurio. La eliminación de estos materiales podría estar regulada debido a consideraciones medioambientales. Para obtener información acerca de la eliminación o del reciclaje, póngase en contacto con sus autoridades locales o con la Alianza de Industrias Electrónicas: en www.eiae.org
16. **Daños que requieran servicio** - El aparato debe recibir servicio de personal de servicio calificado cuando:
 - A. Se ha dañado el cable de alimentación o el enchufe; o

- B. Han caído objetos o se ha derramado líquido dentro del aparato; o
 - C. El aparato ha quedado expuesto a la lluvia; o
 - D. El aparato parece no funcionar normalmente o su rendimiento ha cambiado notoriamente; o
 - E. Se ha dejado caer el aparato o se ha dañado la caja.
- 17. Inclinación/estabilidad** - Todos los televisores deben cumplir con las normas de seguridad generales recomendadas internacionalmente en cuanto a las propiedades de inclinación y estabilidad del diseño de su gabinete.
- No comprometa estas normas de diseño aplicando una fuerza de tracción excesiva a la parte delantera o superior del gabinete lo que finalmente puede hacer que el producto se vuelque.
 - Además, no se ponga en peligro usted mismo o a sus niños colocando equipos electrónicos o juguetes sobre el gabinete. Dichos artículos pueden caer inesperadamente desde la parte superior del producto y dañar el producto y/o causar lesiones personales.
- 18. Montaje en la pared o cielorraso** - El aparato se debe montar en una pared o cielorraso únicamente como lo recomienda el fabricante.
- 19. Líneas de energía eléctrica** - Una antena exterior se debe ubicar lejos de las líneas de energía.
- 20. Conexión a tierra de la antena exterior** - Si se conecta una antena exterior o un sistema de cable al producto, asegúrese de que la antena o el sistema de cable estén conectados a tierra para proporcionar cierta protección contra sobrevoltajes y acumulación de cargas electrostáticas. En la Sección 810 del Código Eléctrico Nacional, ANSI/NFPA 70, se proporciona información sobre la adecuada conexión a tierra de las esteras y estructuras de apoyo, conexión a tierra del alambre de acometida a una unidad de descarga de antena, tamaño de los conectores de conexión a tierra, ubicación de la unidad de descarga de antena, conexión a los electrodos y requerimientos del electrodo de conexión a tierra. Vea la Figura que aparece más abajo.
- 21. Entrada de objetos y líquidos** - Se debe tener cuidado de que no caigan objetos dentro de los orificios de la caja ni se derramen líquidos a través de ellos.
- a) **Advertencia:** Para reducir el riesgo de incendios o de descarga eléctrica, este aparato no se debe exponer a la lluvia ni a la humedad, y no se le deben colocar encima objetos llenos de líquido como jarrones.
- 22. Uso de las baterías PRECAUCIÓN** - Para evitar escapes de las baterías que pueden resultar en lesiones corporales, daño a la propiedad o a la unidad:
- Instale correctamente todas las baterías, con los polos + y - alineados como está marcado en la unidad.
 - No mezcle las baterías (nuevas con antiguas o de carbono con alcalinas, etc.).
 - Retire las baterías cuando no use la unidad por un largo tiempo.

Nota para el instalador del sistema CATV: Se hace este recordatorio para llamar la atención del instalador del sistema CATV sobre el Artículo 820-40 de donde se proporcionan instrucciones para la apropiada conexión a tierra y, en particular, se especifica que la tierra de los cables se conectará al sistema de conexión a tierra del edificio tan cerca del punto de entrada del cable como sea posible.

Ejemplo de conexión a tierra de la antena según NEC, Código Eléctrico Nacional

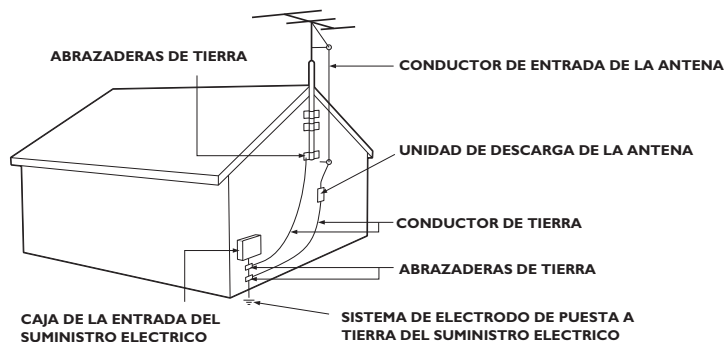

Contents

1	Notice	2
2	Important	3
3	Your TV	5
	Side controls and indicators	5
	Remote control	5
4	Use your TV	7
	Switch your TV on/off or to standby	7
	Switch channels	7
	Watch connected devices	8
	Adjust TV volume	8
5	Use more of your TV	9
	Access TV menus	9
	Remove devices from the home menu	9
	Change picture and sound settings	9
	Create and use list of favorite channels	11
	Use the TV clock	12
	Use timers	12
	Use TV locks	13
	View closed captions (subtitles)	14
	View photos and play music from a USB storage device	14
	Update the TV software	16
	Change TV preferences	16
	Start a TV demo	17
	Reset the TV to factory settings	17
6	Install channels	18
	Select TV tuner	18
	Automatically install channels	18
	Manually install channels	18
	Rename channels	19
	Rearrange channels	19
7	Connect devices	20
	Back connector	20
	Side connector	21
	Connect a computer	22
	Use Philips EasyLink	23
	Use a Kensington lock	24
8	Product information	25
	Supported display resolutions	25
	Multimedia	25
	Tuner/Reception/Transmission	25
	Remote control	25
	Power	25
	Supported TV mounts	26
	Product specification	26
9	Troubleshooting	27
	General TV issues	27
	TV channel issues	27
	Picture issues	27
	Sound issues	28
	HDMI connection issues	28
	Computer connection issues	28
	Contact us	28
10	Index	29

1 Notice

2010 © Koninklijke Philips Electronics N.V. All rights reserved.

Specifications are subject to change without notice. Trademarks are the property of Koninklijke Philips Electronics N.V. or their respective owners. Philips reserves the right to change products at any time without being obliged to adjust earlier supplies accordingly. The material in this manual is believed adequate for the intended use of the system. If the product, or its individual modules or procedures, are used for purposes other than those specified herein, confirmation of their validity and suitability must be obtained. Philips warrants that the material itself does not infringe any United States patents. No further warranty is expressed or implied. Philips cannot be held responsible neither for any errors in the content of this document nor for any problems as a result of the content in this document. Errors reported to Philips will be adapted and published on the Philips support website as soon as possible.

Pixel characteristics

This LCD product has a high number of color pixels. Although it has effective pixels of 99.999% or more, black dots or bright points of light (red, green or blue) may appear constantly on the screen. This is a structural property of the display (within common industry standards) and is not a malfunction.

Warranty

No components are user serviceable. Do not open or remove covers to the inside of the product. Repairs may only be done by Philips Service Centres and official repair shops. Failure to do so shall void any warranty, stated or implied.

Any operation expressly prohibited in this manual, any adjustments, or assembly procedures not recommended or authorised in this manual shall void the warranty.

Copyright

All other registered and unregistered trademarks are the property of their respective owners.

® Kensington and Micro Saver are registered US trademarks of ACCO World corporation with issued registrations and pending applications in other countries throughout the world.

Portions of this software are copyright © The FreeType Project (www.freetype.org).



HDMI, and HDMI logo and High-Definition Multimedia Interface are trademarks or registered trademarks of HDMI licensing LLC.

2 Important

Read and understand all instructions before you use your TV. If damage is caused by failure to follow instructions, the warranty does not apply.

Safety

Risk of electric shock or fire!

- Never expose the TV to rain or water. Never place liquid containers, such as vases, near the TV. If liquids are spilt on or into the TV, disconnect the TV from the power outlet immediately. Contact Philips Consumer Care to have the TV checked before use.
- Never place the TV, remote control or batteries near naked flames or other heat sources, including direct sunlight. To prevent the spread of fire, keep candles or other flames away from the TV, remote control and batteries at all times.



- Never insert objects into the ventilation slots or other openings on the TV.
- When the TV is swiveled ensure that no strain is exerted on the power cord. Strain on the power cord can loosen connections and cause arcing.

Risk of short circuit or fire!

- Never expose the remote control or batteries to rain, water or excessive heat.
- Avoid force coming onto power plugs. Loose power plugs can cause arcing or fire.

Risk of injury or damage to the TV!

- Two people are required to lift and carry a TV that weighs more than 55 lbs.
- When stand mounting the TV, use only the supplied stand. Secure the stand to the TV tightly. Place the TV on a flat, level surface that can support the combined weight of the TV and the stand.
- When wall mounting the TV, use only a wall mount that can support the weight of the TV. Secure the wall mount to a wall that can support the combined weight of the TV and wall mount. Koninklijke Philips Electronics N.V. bears no responsibility for improper wall mounting that results in accident, injury or damage.

Risk of injury to children!

Follow these precautions to prevent the TV from toppling over and causing injury to children:

- Never place the TV on a surface covered by a cloth or other material that can be pulled away.
- Ensure that no part of the TV hangs over the edge of the surface.
- Never place the TV on tall furniture (such as a bookcase) without anchoring both the furniture and TV to the wall or a suitable support.
- Educate children about the dangers of climbing on furniture to reach the TV.

Risk of overheating!

- Never install the TV in a confined space. Always leave a space of at least 4 inches or 10 cm around the TV for ventilation. Ensure curtains or other objects never cover the ventilation slots on the TV.

Risk of damage to the TV!

- Before you connect the TV to the power outlet, ensure that the power voltage matches the value printed on the back of the TV. Never connect the TV to the power outlet if the voltage is different.

Risk of injury, fire or power cord damage!

- Never place the TV or any objects on the power cord.
- To easily disconnect the TV power cord from the power outlet, ensure that you have full access to the power cord at all times.
- When you disconnect the power cord, always pull the plug, never the cable.
- Disconnect the TV from the power outlet and antenna before lightning storms. During lightning storms, never touch any part of the TV, power cord or antenna cable.

Risk of hearing damage!

- Avoid using earphones or headphones at high volumes or for prolonged periods of time.

Low temperatures

- If the TV is transported in temperatures below 5°C, unpack the TV and wait until the TV temperature matches room temperature before connecting the TV to the power outlet.

Screen care

- Avoid stationary images as much as possible. Stationary images are images that remain on-screen for extended periods of time. Examples include: on-screen menus, black bars and time displays. If you must use stationary images, reduce screen contrast and brightness to avoid screen damage.
- Unplug the TV before cleaning.
- Clean the TV and frame with a soft, damp cloth. Never use substances such as alcohol, chemicals or household cleaners on the TV.
- Risk of damage to the TV screen! Never touch, push, rub or strike the screen with any object.
- To avoid deformations and color fading, wipe off water drops as soon as possible.

Disposal of your old product and batteries



Your product is designed and manufactured with high quality materials and components, which can be recycled and reused.



When this crossed-out wheeled bin symbol is attached to a product it means that the product is covered by the European Directive 2002/96/EC. Please inform yourself about the local separate collection system for electrical and electronic products.

Please act according to your local rules and do not dispose of your old products with your normal household waste.

Correct disposal of your old product helps to prevent potential negative consequences for the environment and human health.



Your product contains batteries covered by the European Directive 2006/66/EC, which cannot be disposed with normal household waste.

Please inform yourself about the local rules on separate collection of batteries because correct disposal helps to prevent negative consequences for the environmental and human health.

3 Your TV

Congratulations on your purchase, and welcome to Philips! To fully benefit from the support that Philips offers, register your TV at www.philips.com/welcome.

This section gives you an overview of commonly used TV controls and functions.

Side controls and indicators

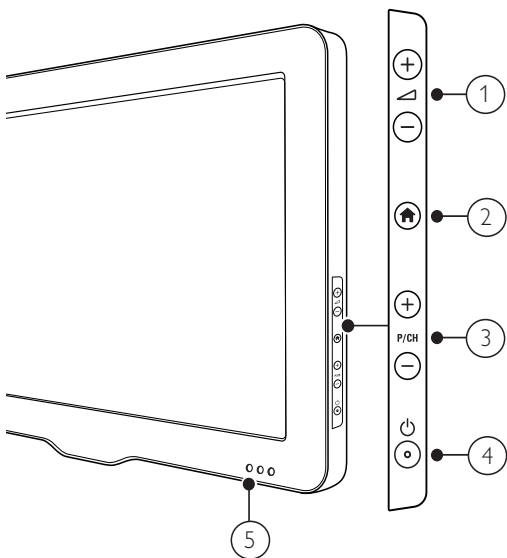

- ① ▲ +/-: Increases or decreases volume.
- ② 🏠 (Home): Toggles the home menu on or off.
- ③ P/CH +/-: Switches to the next or previous channel.
- ④ ⏻ (Power): Switches the product on or off. The product is not powered off completely unless it is physically unplugged.
- ⑤ Standby indicator and remote control sensor.

Remote control

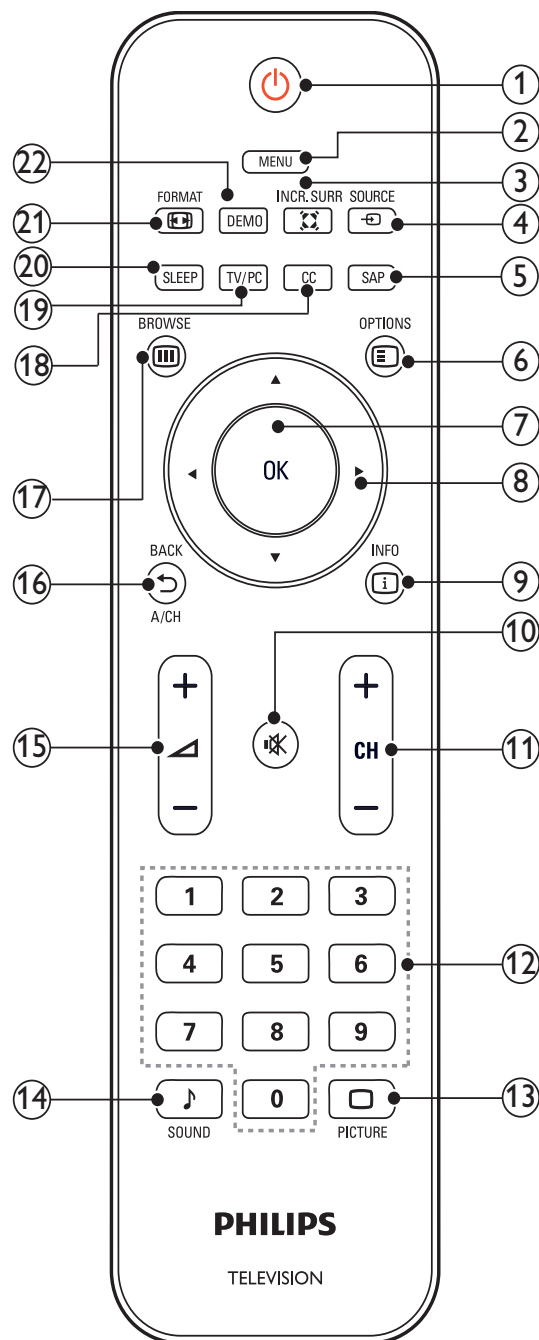

- ① ⏻ (Standby-On)
 - Switches the TV to standby if it is on.
 - Switches on the TV if it is in standby.
- ② MENU
Toggles the main menu on or off.
- ③ 🎧 INCR. SURR
Enables Incredible Surround for stereo sources. Enables spatial mode for mono sources.

- ④ **SOURCE**
Selects connected devices.
- ⑤ **SAP (Secondary audio program)**
Selects Secondary Audio Program (SAP)/ Stereo/ Mono when SAP and/or Stereo is broadcast.
- ⑥ **OPTIONS**
Accesses options relating to the current activity or selection.
- ⑦ **OK**
Confirms an entry or selection and displays the channel grid, when watching TV.
- ⑧ **▲▼◀▶ (Navigation buttons)**
Navigates menus.
- ⑨ **INFO**
Displays program information, if available.
- ⑩ **Mute**
Mutes or restores volume.
- ⑪ **CH +/- (CHANNEL +/-)**
Switches to the next or previous channel. When the TV menu is on, this functions as Page Up/Down.
- ⑫ **0-9 (Numeric buttons)**
Selects a channel or setting.
- ⑬ **PICTURE (Smart picture)**
Launches the picture menu.
- ⑭ **SOUND (Smart Sound)**
Launches the sound menu.
- ⑮ **+/- (Volume +/-)**
Increases or decreases volume.
- ⑯ **BACK/CH**
 - Returns to a previous screen.
 - Returns to the previously viewed channel.
- ⑰ **BROWSE**
Switches between channel grid and program list.
- ⑱ **CC**
Displays closed captions settings.

- ⑲ **TV/PC**
Toggles between PC mode and previously viewed video mode.
- ⑳ **SLEEP**
Sets a delay after which the TV switches to standby.
- ㉑ **FORMAT**
Toggles through available picture formats. Some formats are not available for some picture sources.
- ㉒ **DEMO**
Toggles the demonstration menu on or off.

Remote control usage

When using the remote control, hold it close to the TV and point it at the remote control sensor. Make sure that the line-of-site between the remote control and TV is not blocked by furniture, walls or other objects.

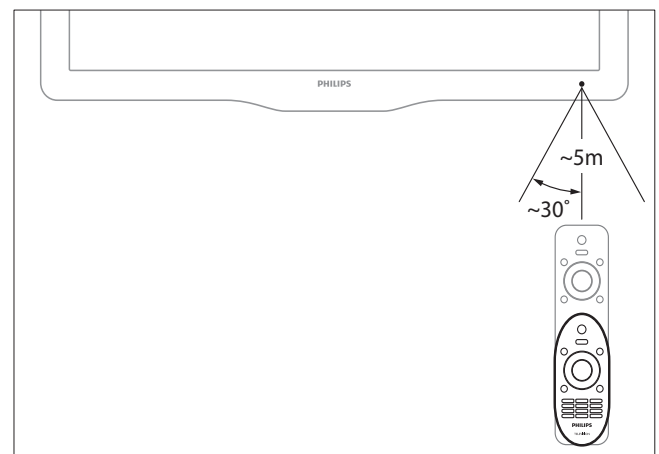

4 Use your TV

This section helps you perform basic TV operations (see 'Use more of your TV' on page 9).

Switch your TV on/off or to standby

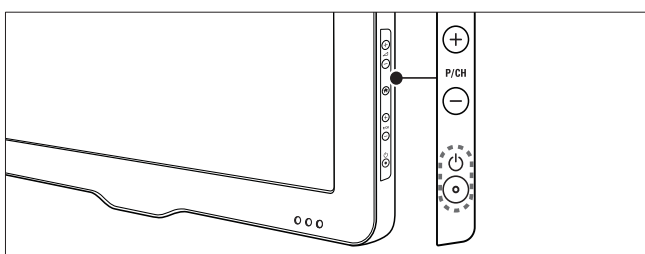

To switch on

- If the standby indicator is off, press **⏻** (**Power**) at the side of the TV.
- If the standby indicator is red, press **⏻** (**Standby-On**) on the remote control.

To switch to standby

- Press **⏻** (**Standby-On**) on the remote control.
 - ↳ The standby indicator switches to red.

To switch off

- Press **⏻** (**Power**) at the side of the TV.
 - ↳ The standby indicator switches off.



Tip

- Though your TV consumes very little power when in standby, energy continues to be consumed. When not in use for an extended period of time, disconnect the TV power cable from the power outlet.

Switch channels

- Press **CH +/-** on the remote control or **P/CH +/-** on the side of the TV.
- Enter a channel number using the **Numeric buttons**.
- Press **OK** to use the channel grid.
- Press **↶ BACK A/CH** on the remote control to return to the previous channel.



Note

- When you use a favourite list, you can only select those channels in the list (see 'Select a favorite list' on page 11).

Switch channels with the channel grid

The channel grid allows you to view all available channels in a grid format.

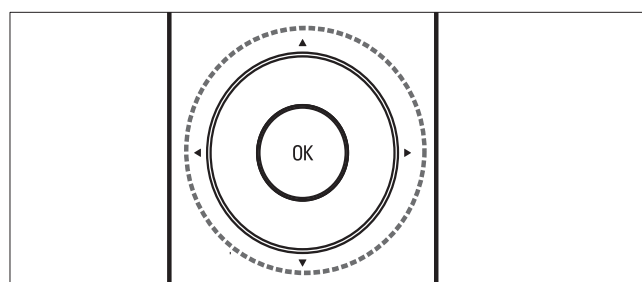

- 1 Press **OK**.
 - ↳ The channel grid appears.
- 2 Press **▲▼◀▶** to browse the channel grid and preview a channel.
 - ↳ The channel content is displayed after about two seconds.
- 3 Press **OK** to select a channel.

Watch connected devices

Note

- Switch on the device before selecting it as a source on the TV.

Use the source button

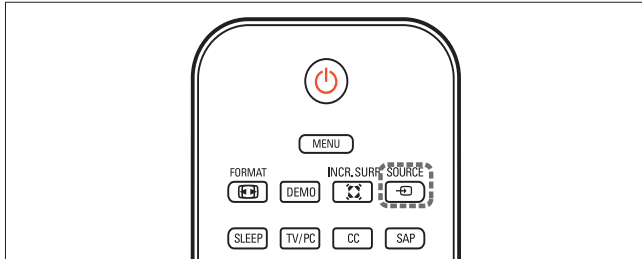

- 1 Press **SOURCE**.
↳ The source list appears.
- 2 Press **▲▼** to select a device.
- 3 Press **OK** to confirm your choice.
↳ The TV switches to the selected device.

Adjust TV volume

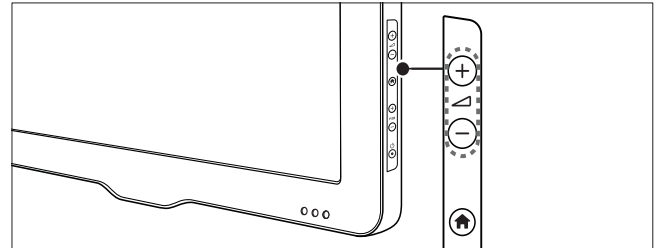
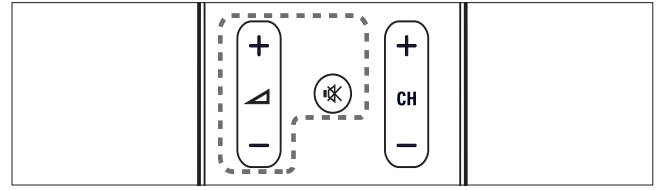

To increase or decrease volume

- Press **▲▼ +/-**.

To mute or unmute sound

- Press **🔇** to mute the sound.
- Press **🔇** again to restore the sound.

5 Use more of your TV

Access TV menus

Menus help you to install channels, change picture and sound settings and access other features.

- 1 Press **MENU**.
↳ The menu screen appears.



- 2 Press **▲▼◀▶** to select and navigate through one of the following menus.
 - **[Watch TV]**: Switches back to the antenna source if another source is selected.
 - **[Add new device]**: Adds new devices to the home menu.
 - **[Setup]**: Accesses menus to change picture, sound and other settings.
- 3 Press **OK** to confirm your choice.
- 4 Press **MENU** to exit.

Tip

- After selecting **[Add new device]**, follow the on-screen instructions to select the correct device and connector.

Remove devices from the home menu

If a device is no longer connected to the TV, remove it from the home menu.

- 1 Press **MENU**.
- 2 Press **▲▼◀▶** to select a device to remove.
- 3 Press **☰** **OPTIONS**.
↳ The **[Remove device]** list appears.
- 4 Press **OK**, then select **[Remove]** to remove the device.
↳ The selected device is removed from the home menu.

Change picture and sound settings

Change picture and sound settings to suit your preferences. You can apply pre-defined settings or change settings manually.

Use smart picture

Use smart picture to apply pre-defined picture settings.

- 1 Press **□** **PICTURE**.
↳ The **[Smart picture]** menu appears.
- 2 Press **▲▼** to select from the following smart picture settings:
 - **[Personal]**: Lists customized picture settings.
 - **[Sports]**: Applies rich and dynamic settings.
 - **[Standard]**: Adjusts picture settings to suit most environments and types of video.
 - **[Movie]**: Applies settings for movie viewing.
 - **[Game]**: Applies settings for games.
 - **[Energy saving]**: Applies low-energy settings.
- 3 Press **OK** to confirm your choice.
↳ The selected smart picture setting is applied.

Manually adjust picture settings

- 1 Press **MENU**.
- 2 Press **▲▼◀▶** to select **[Setup] > [Picture]**.
↳ The **[Picture]** menu appears.
- 3 Press **▲▼◀▶** to select from the following settings and adjust:
 - **[Smart picture]**: Accesses pre-defined smart picture settings.
 - **[Backlight]**: Adjusts the backlight.
 - **[Contrast]**: Adjusts the intensity of bright areas, keeping dark areas unchanged.
 - **[Brightness]**: Adjusts the intensity and details of dark areas.
 - **[Color]**: Adjusts color saturation.
 - **[Tint]**: Adjusts the color balance in an image.
 - **[Sharpness]**: Adjusts sharpness in the image.
 - **[Noise reduction]**: Filters and reduces noise in an image.
 - **[Color temperature]**: Introduces more orange tones (**[Warm]**) or blue tones (**[Cool]**).
 - **[Dig.CrystalClear]**: Adjusts picture quality to optimal contrast, color and sharpness.
 - **[Dynamic contrast]**: Enhances contrast.
 - **[Dynamic backlight]**: Adjusts brightness of the TV backlight to match lighting conditions.
 - **[Color enhancement]**: Makes colors more vivid and improves the details in bright colors. You can switch this feature on or off.
 - **[PC mode]**: Adjusts picture settings when a PC is connected to the TV.
 - **[Picture format]**: Changes the picture format.
 - **[Horizontal shift]**: Adjusts the picture horizontally for PC-VGA or HD input.
 - **[Vertical shift]**: Adjusts the picture vertically for PC-VGA or HD input.

Change picture format

- 1 Press **FORMAT**.
↳ A picture format bar appears.
- 2 Press **▲▼** to select a picture format.
↳ The selected picture format is activated.
- 3 Press **OK** to confirm your choice.

Summary of picture formats

The following picture settings can be configured.

Note

- Depending on the format of the picture source, some picture settings are not available.

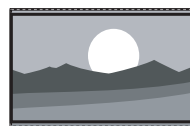

[Super zoom]: (Not for HD and PC mode.) Removes the black bars on the side of 4:3 broadcasts. There is minimal distortion.



[4:3]: Shows the classic 4:3 format.

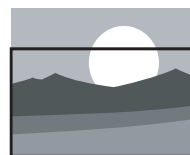

[Subtitle zoom]: Displays 4:3 pictures over the full area of the screen, with sub-titles visible. Part of the top of the picture is clipped off.

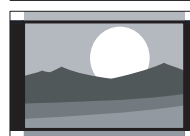

[Movie expand 14:9]: (Not for HD and PC mode.) Scales 4:3 format to 14:9.

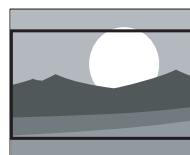

[Movie expand 16:9]: (Not for HD and PC mode.) Scales 4:3 format to 16:9.



[Wide screen]: Scales 4:3 format to 16:9.

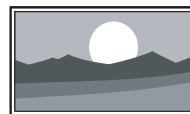

[Unscaled]: For HD and PC mode only, and in selected models only. Allows maximum sharpness. Some distortion may be present due to the broadcaster's systems. Set your PC resolution to wide screen mode for best results.

Use smart sound

Use smart sound to apply pre-defined sound settings.

- 1 Press **SOUND**.
↳ The **[Smart sound]** menu appears.
- 2 Press **▲▼◀▶** to select a smart sound setting:
 - **[Standard]**: Adjusts sound settings to suit most environments and types of audio.
 - **[News]**: Applies settings for spoken audio, such as news.
 - **[Movie]**: Applies settings for movies.
 - **[Personal]**: Applies the settings that were customized in the sound menu.
- 3 Press **OK** to confirm your choice.
↳ The selected smart sound setting is applied.

Manually adjust sound settings

- 1 Press **MENU**.
- 2 Press **▲▼◀▶** to select **[Setup] > [Sound]**.
↳ The **[Sound]** menu appears.
- 3 Press **▲▼◀▶** to select and adjust:
 - **[Smart sound]**: Accesses pre-defined smart sound settings.
 - **[Bass]**: Adjusts the bass level.
 - **[Treble]**: Adjusts the treble level.
 - **[Volume]**: Adjusts the volume.
 - **[Balance]**: Adjusts the balance of the right and left speakers.
 - **[SAP]**: Selects a second broadcast audio language.
 - **[Mono/Stereo]**: Selects mono or stereo if stereo broadcast is available.
 - **[TV speakers]**: Sets the TV speakers on or off, or outputs sound to an EasyLink-compliant device. Easylink must be activated in the preferences menu.

- **[Surround]**: Enables spatial sound.
- **[Auto volume]**: Automatically reduces sudden volume changes, for example, when switching channels.
- **[Delta volume]**: Levels out volume differences between channels or connected devices. Switch to the connected device before you change the delta volume.

Create and use list of favorite channels

You can create a list of your preferred TV channels so that you can find those channels easily.

Select a favorite list

- 1 When watching TV, press **OK** to display the channel grid.
- 2 Press **☰** **OPTIONS**.
↳ The channel options menu appears.
- 3 Press **▲▼** to select **[Select list]**, then press **OK** to enter.
↳ The channel list options appear.
- 4 Select **[Favorite]**, then press **OK**.
↳ Only channels in the favorite list appear in the channel grid.



Note

- The favorite channel grid is empty until you add channels into the favorite lists.

Add a channel to a favorite list

- 1 When watching TV, press **OK**.
↳ The channel grid appears.
- 2 Press **▲▼◀▶** to select a channel to add to a favorite list.
- 3 Press **☰** **OPTIONS**.
↳ The channel options menu appears.

- 4 Select **[Mark as favorite]**, then press **OK**.
↳ The channel is added to the favorite list.

Note

- All favorite channels are marked by an asterisk in the channel grid.

Remove a channel from a favorite list

- 1 When watching TV, press **OK**.
↳ The channel grid appears.
- 2 Press **▲▼◀▶** to select a channel to remove.
- 3 Press **☰** **OPTIONS**.
- 4 Select **[Unmark as fav.]**, then press **OK**.
↳ The channel is removed.

Use the TV clock

You can display the TV clock. (only available in RF)

Set the TV clock

- 1 Press **MENU**.
- 2 Select **[Setup] > [Features] > [Clock]**
↳ The **[Clock]** menu appears.
- 3 Press **▲▼◀▶** or the **Numeric buttons** to enter time.
- 4 Select **[Done]** and press **OK** to confirm.
- 5 Press **MENU** to exit.

Display the TV clock

- 1 When watching TV, press **☰** **OPTIONS**.
↳ The TV option menu appears.
- 2 Select **[Clock]**.
- 3 Press **OK**.

Note

- To disable the clock, repeat the above procedure.

Use timers

You can set timers to switch the TV to standby at a specified time.

Tip

- Set the TV clock before you use timers.

Automatically switch the TV to standby (sleep timer)

Sleep timer switches the TV to standby after a pre-defined period of time.

Tip

- You can switch off your TV earlier or reset the sleep timer during the countdown.

- 1 Press **MENU**.
- 2 Press **▲▼◀▶** to select **[Setup] > [Features] > [Sleep timer]**.
↳ The **[Sleep timer]** menu appears.
- 3 Press **◀▶** to set the sleep time.
↳ The sleep timer can be up to 180 minutes in steps of five minutes. If set to zero, the sleep timer is switched off.
- 4 Press **OK** to switch on the sleep timer.
↳ The TV switches to standby after the specified time.

Automatically switch the TV on (on timer)

You can switch on the TV from standby to a specific channel at a specified time.

- 1 Press **MENU**.
- 2 Press **▲▼◀▶** to select **[Setup] > [Features] > [On timer]**.
- 3 Press **▶** to enter the **[On timer]** menu.
 - **[Activate]**: Selects how often the TV is switched on.
 - **[Time]**: Sets the time to switch on the TV.
 - **[Channel no.]**: Selects the channel.
- 4 Press **MENU** to exit.



Tip

- Select **[On timer] > [Activate] > [Off]** to disable this feature.

Use TV locks

You can prevent your children from watching certain programs or channels by locking the TV controls.

Set or change your PIN code

- 1 Press **MENU**.
- 2 Press **▲▼◀▶** to select **[Setup] > [Features] > [Set code] / [Change code]**.
 - ↳ The **[Set code] / [Change code]** menu appears.
- 3 Enter your code using the **Numeric buttons**.
 - ↳ Follow the on-screen instructions to create or change your PIN code.



Tip

- If you forget your code, enter '8888' to override any existing codes.

Lock or unlock the TV

Lock the TV to prevent access to all channels and connected devices.

- 1 Press **MENU**.
- 2 Press **▲▼◀▶** to select **[Setup] > [Features] > [TV lock]**.
 - ↳ You are prompted to enter your PIN code.
- 3 Enter your code with the **Numeric buttons**.
 - ↳ The **[TV lock]** menu appears.
- 4 Press **▲▼** to select **[Lock]** or **[Unlock]**.
- 5 Press **OK** to confirm.
 - ↳ All channels and connected devices are locked or unlocked.
- 6 Press **MENU** to exit.



Note

- If you select **[Lock]**, you have to enter your code every time you turn on your TV.

Lock or unlock one or more channels

- 1 When watching TV, press **OK** to display the channel grid.
- 2 Press **▲▼◀▶** to select a channel to lock or unlock.
- 3 Press **☰** **OPTIONS**.
- 4 Press **▲▼** to select **[Lock channel]** or **[Unlock channel]**, then press **OK**.
 - ↳ You are prompted to enter your PIN code.
- 5 Enter your code and press **OK**.
 - ↳ If the channel is locked, a lock icon displayed.
- 6 Repeat the process to lock or unlock more channels.

 Note

- Switch the TV off and on again for the change to take effect.
- If you access the locked channels, you are prompted to enter your PIN code.

View closed captions (subtitles)

The caption service displays transmitted closed caption text. The captioned text can be displayed permanently or only when the TV is muted.

 Note

- This television provides a display of television closed captioning that conforms with the EIA-608 standard and in accordance with Sections 15.119 of the FCC rules.
- If you connect your set-top box via HDMI or component video input, you cannot select closed caption through the TV. You can select closed caption through the set-top box only.
- The captions do not always use correct spelling and grammar.
- Not all TV programs and product commercials include closed caption information. Refer to your area TV program listings for the TV channels and times of closed caption shows. The captioned programs are usually noted in the TV listings with service marks such as 'CC'.

- 1 Press **MENU**.
- 2 Select **[Setup] > [Features] > [Closed caption]**.
- 3 Press **▶** to enter **[Closed caption]**.
- 4 Press **▲▼** to select your preference.
- 5 Press **OK**.
- 6 Press **MENU** to exit.

View photos and play music from a USB storage device

Use the USB connector to view photos or listen to music stored on a USB storage device.

 Note

- Your TV only supports USB flash drives in FAT/FAT32 format. It does not support other devices that can be connected to the USB port including but not limited to the following: portable storage devices such as external hard drives and mini hard drives, MP3 player, digital camera, phone, portable video player, portable multimedia player.

Connect a USB storage device and enter the content browser

- 1 Turn on the TV.
- 2 Connect the USB storage device to the TV.
- 3 Press **MENU**.
↳ The home menu appears.
- 4 Press **▲▼◀▶** to select **[Browse USB]**.
- 5 Press **OK** to confirm.
↳ The USB content browser appears.

 Tip

- Press **⏏ BROWSE** to switch between thumbnail and file browsing views.

View photos

- 1 In the USB browser, press ► to enter the **[Picture]** folder.
- 2 Press ▲▼◀▶ to select a photo or a photo album.
- 3 Press **OK** to view a full screen image of the photo.



Tip

- When in full screen mode, press ◀▶ to move between photos.

View a slide show of your photos

- 1 When a full screen image of a photo is displayed, press **OK**.
 - ↳ A slide show begins from the selected photo.
- 2 Press the following buttons to control the slide show:
 - **OK** to pause the slide show.
 - ◀▶ to go back or move forward to the next image.
 - ↶ **BACK** to stop the slide show.

Change slide show settings

- 1 When viewing a slide show, press **☰ OPTIONS**.
 - ↳ The slide show options menu appears.
- 2 Press ▲▼◀▶ to select from the following settings and adjust:
 - **[Start slideshow] / [Stop slideshow]**: Starts or stops a slide show.
 - **[Slideshow transitions]**: Displays a list of transition styles.
 - **[Slideshow frequency]**: Sets the amount of time that a picture is shown.
 - **[Rotate image]**: Rotates a picture.
 - **[Show info]**: Displays the picture name, date, size and next picture in the slide show.
- 3 Press **OK** to confirm the setting change.

Listen to music

- 1 In USB browser view, select **[MUSIC]** and press ► to enter.
- 2 Press ▲▼◀▶ to select a music track or album.
- 3 Press **OK** to play the selected music.

Button	Function
OK	Pause, resume play or stop playback.
◀/▶	Go to the previous or next music.

Music settings

When listening music, press **☰ OPTIONS** to access one of the following music settings.

- **[Start playback] / [Stop playback]**: Starts or stops the music.
- **[Play mode]**:
 - **[Play once]**: Disables repeat play and plays a song once.
 - **[Repeat]**: Repeats a song.
 - **[Shuffle]**: Plays songs randomly.
- **[Show info]**: Displays the file name.
- **[TV speakers]**: Sets the TV speakers on or off.

View a slide show with music

You can view picture slide show with background music.

- 1 Select an album of songs.
- 2 Press **OK**.
- 3 Press ↶ **BACK** to return to USB content browser.
- 4 Select an album of pictures.
- 5 Press **OK** to view photo.
- 6 Press **OK** again to start slide show.

Disconnect a USB storage device

Caution

- Follow this procedure to avoid damage to your USB storage device.

- 1 Press **↩ BACK** to exit the USB browser.
- 2 Wait for five seconds then disconnect the USB storage device.

Update the TV software

Philips continuously tries to improve its products and we recommend that you update the TV software when updates are available. Check www.philips.com/support for availability.

Check the current software version

- 1 Press **MENU**.
- 2 Select **[Setup] > [Software update] > [Current software]**.
 - ↳ The TV displays the current software information.

Download the software

- 1 On your PC, open a web browser and go to www.philips.com/support.
- 2 Download the latest software upgrade file to your PC.
- 3 Decompress the ZIP-file.
- 4 Copy the file to the root directory of the USB device.

Update using a USB device

Connect your USB device to the USB port at the side of your TV.

- 1 If the software update screen does not appear automatically, select **[Setup] > [Software update] > [Local updates]**.
- 2 Press **OK** to update the TV software manually.
- 3 Follow the on-screen instructions to complete the update.

Note

- The TV restarts after the software update is complete.

Change TV preferences

Use the preferences menu to customize your TV settings.

- 1 Press **MENU**.
- 2 Select **[Setup] > [Installation] > [Preferences]**.
 - **[Location]**: Optimizes TV settings for your location - home or shop.
 - **[Volume bar]**: Displays the volume bar when you adjust the volume.
 - **[EasyLink]**: Enables one-touch play and one-touch standby between EasyLink-compliant devices.
 - **[Pixel Plus Link]**: Overrides the settings of connected devices and uses the settings of the TV.
 - **[E-sticker]**: For shop mode only. Sets the location of the e-sticker.
- 3 Press **MENU** to exit.

Start a TV demo

You can use demonstrations to better understand the features of your TV. Some demos are not available on certain models. Available demos are displayed in the menu list.

- 1 Press **DEMO** on the remote control.
- 2 Press **▲▼** to select a demo and press **OK** to view it.
- 3 Press **↶ BACK** to exit.

Reset the TV to factory settings

You can restore the default picture and sound settings of your TV. The channel installation settings remain the same.

- 1 Press **MENU**.
- 2 Select **[Setup] > [Installation] > [Factory settings]**.
- 3 Press **▶** to enter **[Factory settings]**.
- 4 Select **[Reset]** to start resetting.
- 5 Press **OK**.
- 6 Press **MENU** to exit.

6 Install channels

The first time you setup your TV, you are prompted to select a menu language and to install TV and digital radio channels (if available). This chapter provides instructions on how to re-install and fine tune channels.

Select TV tuner

- 1 Press **MENU**.
- 2 Select **[Setup] > [Installation] > [Channel install.] > [Tuner mode]**
- 3 Press **▲▼** to select the source of TV broadcast, then press **OK** to confirm the selection.
- 4 Press **◀** to return to previous menu.

 **Note**

- If you are not sure what TV source to use, select **[Auto]**.

Automatically install channels

This section describes how to search and store channels automatically.

- 1 Press **MENU**.
- 2 Select **[Setup] > [Installation] > [Channel install.] > [Channel assistant]**.
- 3 Press **OK**.
- 4 Follow the on-screen instructions to install channels.

Manually install channels

This section describes how to search and store analog TV channels manually.

Select your system

 **Note**

- Skip this step if your system settings are correct.

- 1 Press **MENU**.
- 2 Press **▲▼◀▶** to select **[Setup] > [Installation] > [Channel install.] > [Manual install]**.
↳ The **[Manual install]** menu appears.
- 3 Press **▲▼** to select **[Color system]**, then press **▶** to enter.
- 4 Select your system, then press **OK** to confirm.
- 5 Repeat the previous steps for **[Sound system]**.
- 6 Press **MENU** to exit.

Fine tune analog channels

- 1 Press **MENU**.
- 2 Press **▲▼◀▶** to select **[Setup] > [Installation] > [Channel install.] > [Manual install]**.
↳ The **[Manual install]** menu appears.
- 3 Press **▲▼** to select **[Fine-tune]**, then press **▶** to enter.
- 4 Press **▲▼** to adjust frequency.
- 5 Press **OK** to confirm.
- 6 Press **MENU** to exit.

Skip channels

- 1 When watching TV, switch to the channel you want to skip.
- 2 Press **MENU**.
- 3 Press **▲▼◀▶** to select **[Setup]** > **[Installation]** > **[Channel install.]** > **[Manual install]**.
↳ The **[Manual install]** menu appears.
- 4 Press **▲▼** to select **[Skip channel]**, then press **▶** to enter.
- 5 Press **▲▼** to select **[Skip]** > **[Yes]**, then press **OK** to skip current channel.
↳ The selected channel is skipped when you press **CH +/-** on your remote control or view the channel grid.
- 6 Repeat the previous steps to skip more channels.



Tip

- Use the **Numeric buttons** on the remote control to access the skipped channel.
- To access the skipped channel, repeat steps 1-5 and select **[No]** to restore.



Tip

- The device name can be up to six characters long.
- Press **[Aa]** to change uppercase letter to lowercase letter and vice versa.

Rearrange channels

After you install channels, you can rearrange the order in which they appear:

- 1 When watching TV, press **OK** to display the channel grid.
- 2 Press **☰** **OPTIONS**.
↳ The channel options menu appears.
- 3 Press **▲▼** to select **[Reorder]**, then press **OK**.
- 4 Select the channel to rearrange, then press **OK**.
↳ The selected channel is highlighted.
- 5 Press **▲▼◀▶** to move the highlighted channel to the desired location, then press **OK**.
- 6 Press **☰** **OPTIONS**.
↳ **[Done reordering]** appears on the screen.
- 7 Press **OK** to confirm.
- 8 Press **↶** **BACK** to exit the channel grid.

Rename channels

You can rename channels. The name appears when you select the channel.

- 1 When watching TV, press **OK** to display the channel grid.
- 2 Select the channel to rename.
- 3 Press **☰** **OPTIONS**.
↳ The channel options menu appears.
- 4 Press **▲▼** to select **[Rename channel]**, then press **OK**.
↳ A text input box appears.
- 5 Press **▲▼◀▶** to select characters.
- 6 Press **OK** to confirm each characters.
- 7 Select **[Done]**, then press **OK** to finish renaming channels.

7 Connect devices

This section describes how to connect various devices with different connectors and supplements examples provided in the Quick Start.

Caution

- Disconnect the mains cord before connecting devices.

Note

- Different types of connectors may be used to connect a device to your TV, depending on availability and your needs.

Back connector

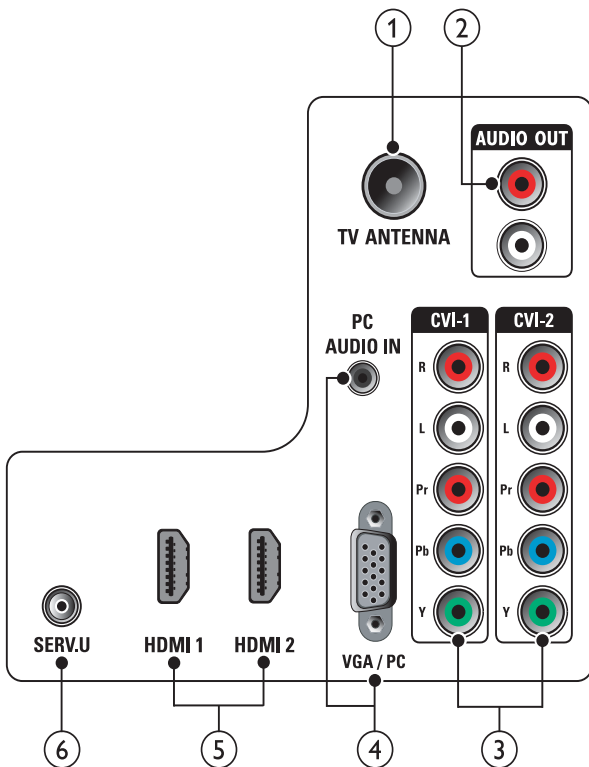

- ① **TV ANTENNA**
Signal input from an antenna, cable or satellite.

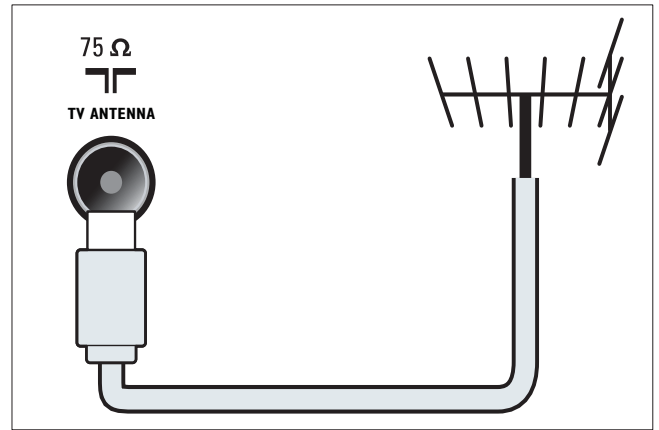

- ② **AUDIO OUT**
Analog audio output to home theaters and other audio systems.

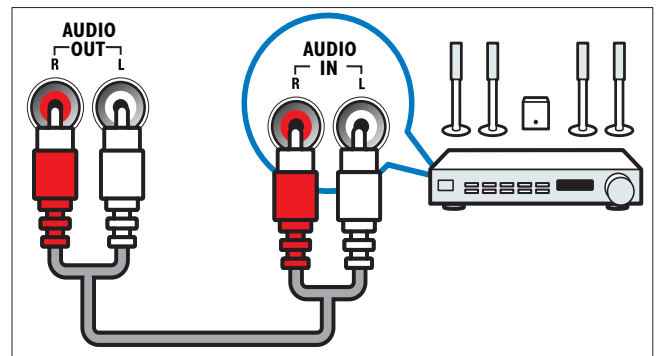

- ③ **CVI 1 / CVI 2 (Y Pb Pr and AUDIO L/R)**
Analog audio and video input from analog or digital devices such as DVD players or game consoles.

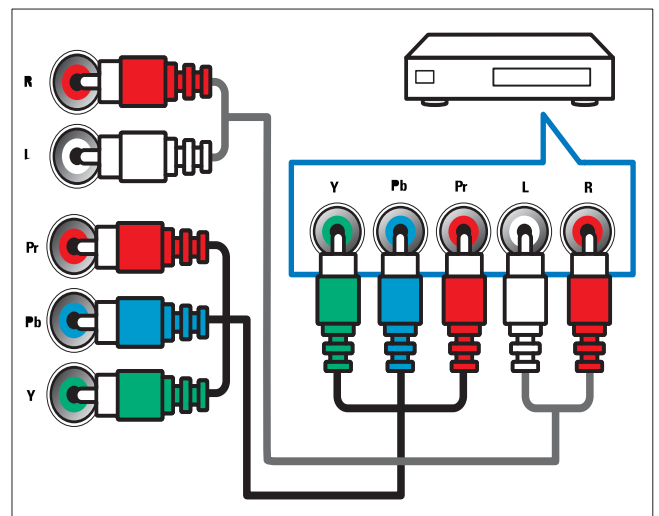

- ④ **PC IN (VGA / PC and AUDIO IN)**
Audio and video input from a computer.

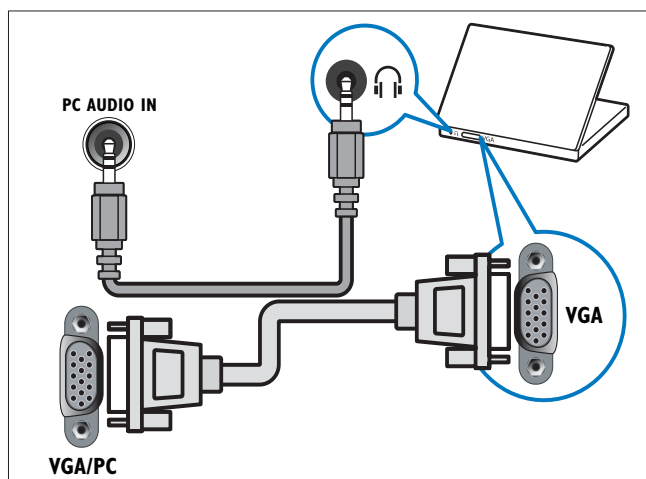

- ⑤ **HDMI 1 / HDMI 2**
Digital audio and video input from high-definition digital devices such as Blu-ray players.

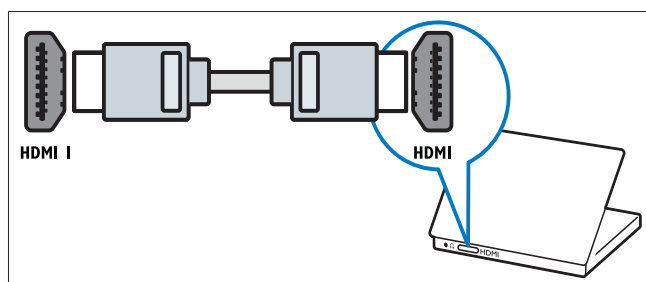

Connections via DVI or VGA require an additional audio cable.

- ⑥ **SERV. U**
For use by service personnel only.

Side connector

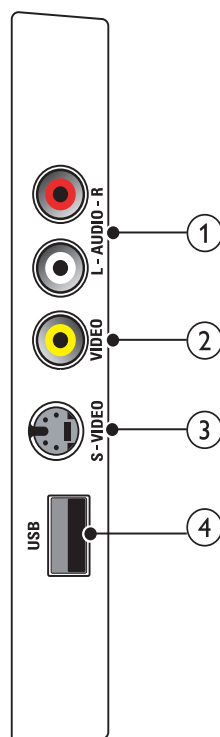

- ① **AUDIO L/R**
Audio input from analog devices connected to **VIDEO**.

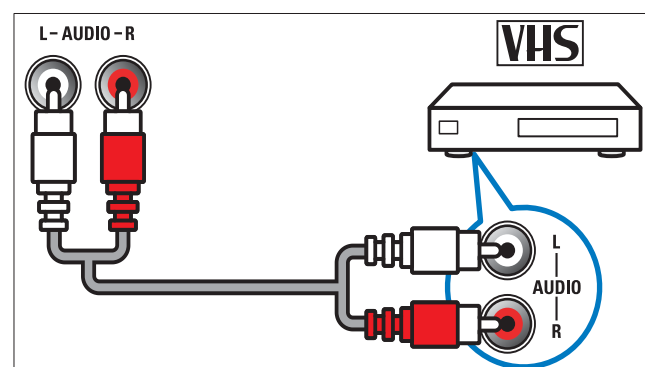

② VIDEO

Composite video input from analog devices such as VCRs.

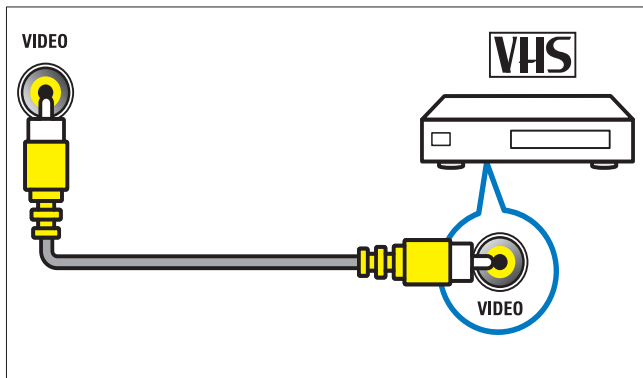

③ S-VIDEO

S-Video (side) to be used with Audio L/R connectors for camcorder, game console, etc. When you use the S-Video (side) for video signals, do not use the Composite video (side) input for video signals.

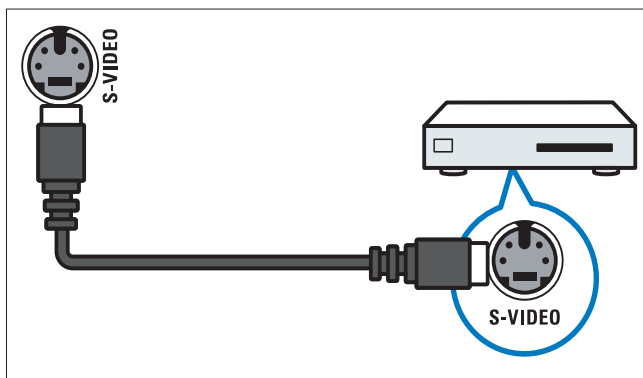

④ USB

Data input from USB storage devices.

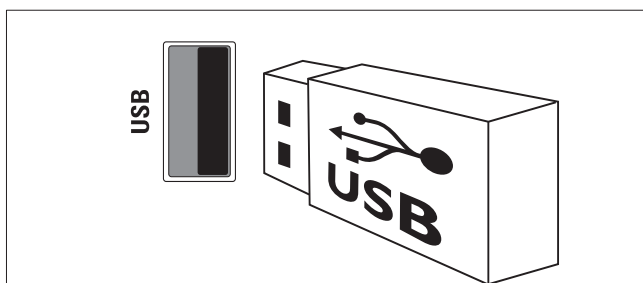

Connect a computer

Before you connect a computer to the TV

- Set the monitor refresh rate on your computer to 60Hz.
- Press **FORMAT** and change the TV picture format to **[Unscaled]**.

Connect a computer with one of the following connectors:

Note

- Connections via DVI or VGA require an additional audio cable.

- **HDMI cable**

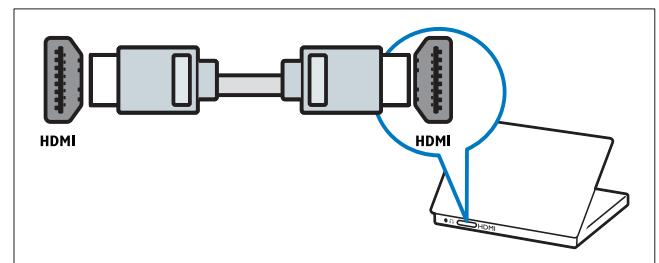

- **DVI-HDMI cable**

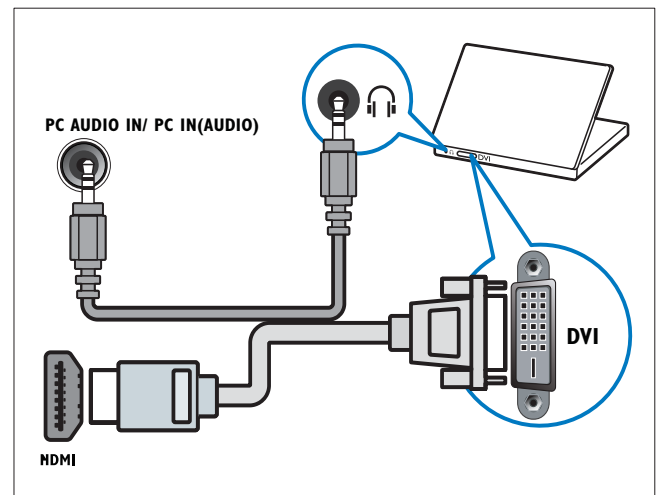

- HDMI cable and HDMI-DVI adaptor

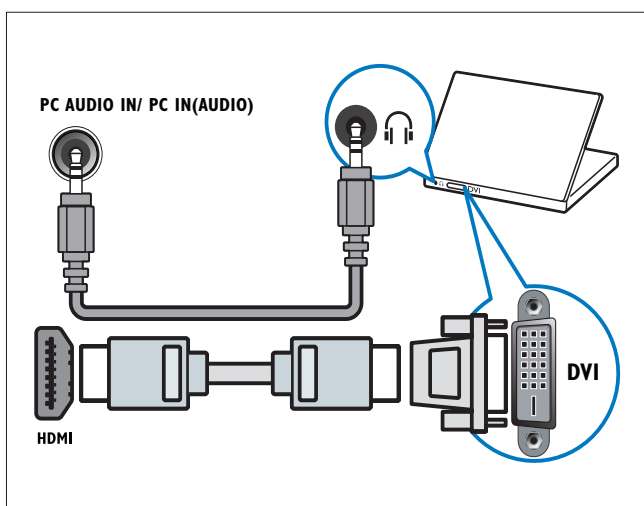

- VGA cable

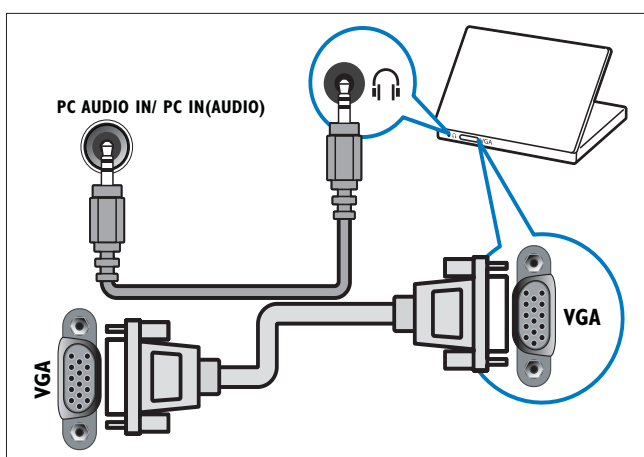

Use Philips EasyLink

Your TV supports Philips EasyLink, which uses the HDMI CEC (Consumer Electronics Control) protocol. EasyLink-compliant devices that are connected through HDMI connectors can be controlled by a single remote control.

Note

- The EasyLink-compliant device must be switched on and selected as the source.
- Philips does not guarantee 100% interoperability with all HDMI CEC devices.

EasyLink features

One-touch play

When you connect your TV to devices that support one-touch play, you can control your TV and the devices with one remote control.

One-touch standby

When you connect your TV to devices that support standby, you can use your TV remote control to put your TV and all connected HDMI devices in standby mode.

System audio control

When you connect your TV to HDMI CEC compliant devices, your TV can switch automatically to play audio from the connected device.

To use one-touch audio, you must map the audio input from the connected device to your TV.

You can use the remote control from the connected device to adjust the volume.

Enable or disable EasyLink

Note

- Do not enable Philips EasyLink if you do not intend to use it.

- 1 Press **MENU**.
- 2 Press **▲▼◀▶** to select **[Setup]** > **[Installation]** > **[Preferences]** > **[EasyLink]**.
- 3 Select **[On]** or **[Off]**.

Use one-touch play

- 1 After enabling EasyLink, press play on your device.
 - ↳ The TV automatically switches to the correct source.

Use one-touch standby

- 1 Press **⏻ (Standby-On)** on the TV's or device's remote control.
 - ↳ The TV and all connected HDMI devices switch to standby.

Set TV speakers to EasyLink mode

When you play content from an EasyLink compliant home theater, the TV speakers are automatically muted.

- 1 Press **MENU**.
- 2 Press **▲▼◀▶** to select **[Setup]** > **[Sound]** > **[TV speakers]** > **[Auto EasyLink]**.
 - ↳ The TV speakers are turned off automatically when content from an Easylink compliant system is detected.
- 3 Select **[Setup]** > **[Sound]** > **[TV speakers]** > **[On]** to disable system audio control and enable the TV speakers.

Use a Kensington lock

There is a Kensington security slot at the back of the TV. Prevent theft by looping a Kensington lock between the slot and a permanent object, such as a heavy table.

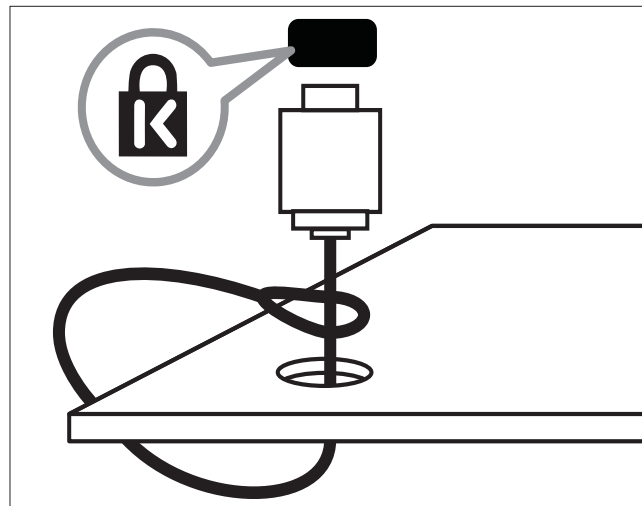

8 Product information

Product information is subject to change without notice. For detailed product information, go to www.philips.com/support.

Supported display resolutions

Computer formats (HDMI)

- Resolution - refresh rate:
 - 640 × 480 - 60Hz
 - 800 × 600 - 60Hz
 - 1024 × 768 - 60Hz
 - 1280 × 1024 - 60Hz
 - 1360 × 768 - 60Hz
 - 1920 × 1080 - 60Hz

Computer formats (VGA)

- Resolution - refresh rate:
 - 640 × 480 - 60Hz
 - 800 × 600 - 60Hz
 - 1024 × 768 - 60Hz
 - 1280 × 1024 - 60Hz
 - 1360 × 768 - 60Hz

Video formats

- Resolution - refresh rate:
 - 480i - 60Hz
 - 480p - 60Hz
 - 576i - 50Hz
 - 576p - 50Hz
 - 720p - 50Hz, 60Hz
 - 1080i - 50Hz, 60Hz
 - 1080p - 24Hz, 25Hz, 30Hz, 50Hz, 60Hz

Multimedia

- Supported storage device: USB (Only FAT 16 or FAT 32 USB storage devices are supported)
- Supported multimedia file formats:
 - Images: JPEG
 - Audio: MP3



Note

- Multimedia file names must not exceed 128 characters.

Tuner/Reception/Transmission

- Antenna input: 75ohm coaxial (IEC75)
- TV system: NTSC, PAL-M, PAL-N
- Video playback: NTSC, PAL

Remote control

- Batteries: 2 × AAA (R03 type)

Power

- Mains power: 220-240 V ~, 50-60 Hz
- Standby power: < 1 W
- Ambient temperature: 5 to 40 degrees Celsius

Supported TV mounts

To mount the TV, purchase a Philips TV mount or a VESA-compatible TV mount. To prevent damage to cables and connectors, be sure to leave a clearance of at least 2.2 inches or 5.5cm from the back of the TV.



Warning

- Follow all instructions provided with the TV mount. Koninklijke Philips Electronics N.V. bears no responsibility for improper TV mounting that results in accident, injury or damage.

TV screen size (inches)	Required pitch (mm)	Required mounting bolts
32	200 × 200	4 × M6
42	300 × 200	4 × M6

Product specification

Design and specifications are subject to change without notice.

32PFL3605

- Without TV stand
 - Dimension (WxHxD): 795.6 × 508.3 × 93 (mm)
 - Weight: 8.3 kg
- With TV stand
 - Dimension (WxHxD): 795.6 × 556.2 × 221.5 (mm)
 - Weight: 9.9 kg

32PFL3615

- Without TV stand
 - Dimension (WxHxD): 795.6 × 508.3 × 93 (mm)
 - Weight: 8.3 kg
- With TV stand
 - Dimension (WxHxD): 795.6 × 556.2 × 221.5 (mm)
 - Weight: 9.9 kg

42PFL3605

- Without TV stand
 - Dimension (WxHxD): 1018.5 × 635.7 × 83 (mm)
 - Weight: 11.5 kg
- With TV stand
 - Dimension (WxHxD): 1018.5 × 683.5 × 236.4 (mm)
 - Weight: 13.5 kg

42PFL3615

- Without TV stand
 - Dimension (WxHxD): 1018.5 × 635.7 × 83 (mm)
 - Weight: 11.5 kg
- With TV stand
 - Dimension (WxHxD): 1018.5 × 683.5 × 236.4 (mm)
 - Weight: 13.5 kg

9 Troubleshooting

This section describes commonly encountered issues and accompanying solutions.

General TV issues

The TV does not switch on:

- Disconnect the power cable from the power outlet. Wait for one minute then reconnect it.
- Check that the power cable is securely connected.

The remote control is not working properly:

- Check that the remote control batteries are correctly inserted according to the +/- orientation.
- Replace the remote control batteries if they are flat or weak.
- Clean the remote control and TV sensor lens.

The standby light on the TV blinks red:

- Disconnect the power cable from the power outlet. Wait until the TV cools down before reconnecting the power cable. If the blinking reoccurs, contact Philips Consumer Care.

You forgot the code to unlock the TV lock feature

- Enter '8888'.

The TV menu is in the wrong language.

- Change the TV menu to your preferred language.

When turning the TV on/off/to standby, you hear a creaking sound from the TV chassis:

- No action is required. The creaking sound is normal expansion and contraction of the TV as it cools and warms up. This does not impact performance.

Cannot remove 'e-sticker' banner displayed on the TV.

- To remove the logos and images, set the location of your TV to home.
 1. Press **MENU**.
 2. Select **[Setup] > [Installation] > [Preferences] > [Location]**.
 3. Select **[Home]**, then press **OK**.

TV channel issues

Previously installed channels do not appear in the channel list:

- Check that the correct channel list is selected.

Picture issues

The TV is on, but there is no picture:

- Check that the antenna is properly connected to the TV.
- Check that the correct device is selected as the TV source.

There is sound but no picture:

- Check that the picture settings are correctly set.

There is poor TV reception from an antenna connection:

- Check that the antenna is properly connected to the TV.
- Loud speakers, unearthed audio devices, neon lights, high buildings and other large objects can influence reception quality. If possible, try to improve the reception quality by changing the antenna direction or moving devices away from the TV.
- If reception on only one channel is poor, fine tune this channel.

There is poor picture quality from connected devices:

- Check that the devices are connected properly.
- Check that the picture settings are correctly set.

The TV did not save your picture settings:

- Check that the TV location is set to the home setting. This mode offers you the flexibility to change and save settings.

The picture does not fit the screen; it is too big or too small:

- Try using a different picture format.

The picture position is incorrect:

- Picture signals from some devices may not fit the screen correctly. Check the signal output of the device.

Sound issues

There is picture but no sound from the TV:

Note

- If no audio signal is detected, the TV automatically switches the audio output off — this does not indicate malfunction.

- Check that all cables are properly connected.
- Check that the volume is not set to 0.
- Check that the sound is not muted.

There is picture but sound quality is poor:

- Check that the sound settings are correctly set.

There is picture but sound comes from one speaker only:

- Verify that sound balance is set to the center.

HDMI connection issues

There are problems with HDMI devices:

- Note that HDCP (High-bandwidth Digital Content Protection) support can delay the time taken for a TV to display content from a HDMI device.
- If the TV does not recognize the HDMI device and no picture is displayed, try switching the source from one device to another and back again.

- If there are intermittent sound disruptions, check that output settings from the HDMI device are correct.
- If you use an HDMI-to-DVI adapter or HDMI to DVI cable, check that an additional audio cable is connected to **AUDIO IN** (mini-jack only).

Computer connection issues

The computer display on the TV is not stable:

- Check that your PC uses the supported resolution and refresh rate.
- Set the TV picture format to unscaled.

Contact us

If you cannot resolve your problem, refer to the FAQs for this TV at www.philips.com/support.

If the problem remains unresolved, contact Philips Consumer Care in your country as listed in this user manual.



Warning

- Do not attempt to repair the TV yourself. This may cause severe injury, irreparable damage to your TV or void your warranty.



Note

- Make a note of your TV model and serial number before you contact Philips. These numbers are printed on the back of the TV and on the packaging.

10 Index

A	
analog	
fine-tune	18
<hr/>	
B	
batteries	25, 4
bracket for wall mount	26
<hr/>	
C	
care	4
channel grid	7
channels	
favorites list	11
fine-tune	18
grid	7
install	
automatic	18
manual	18
list	11
lock	13
rename	19
reorder/rearrange	19
skip channels	19
switch	7
troubleshooting	27
tune	18
child lock	
lock channels	13
lock connected devices	13
PIN code	13
clock	
display	12
closed captions	14
computer	
connect	28, 22
display resolution	25
connect	
PC	28, 22
connectors	
HDMI	28, 20
overview	20
<hr/>	
D	
default settings	17
demo	17
devices	8
devices	
add to home menu	9
remove	9
watch	8
digital services	
disconnect USB	16
display	
resolution	25
dispose	4
<hr/>	
E	
EasyLink	
disable	24
enable	24
one-touch play	24
one-touch standby	24
system audio control	24
end of life	4
environmental care	4
e-sticker	16
<hr/>	
F	
factory settings	17
favorites list	
create list	11
view list	11
fine tune channels	18
<hr/>	
H	
HDMI	28, 20
home mode	16
<hr/>	
I	
install channels	
automatic	18
manual	18

K
Kensington lock 24

L
language
troubleshoot 27
list
favorites list 11
location
home or shop 16
lock
Kensington lock 24
lock channels 13
lock connected devices 13
PIN code 13

M
menu
main menu 9
MPEG artifact reduction 10
multimedia 25
music
USB 15
with slideshow 15
mute TV speakers 24

O
on timer 13, 12
one-touch play 24
one-touch standby 24

P
PC
connect 28
resolution 25
picture format
change 10
troubleshooting 27
picture settings 9
PIN code 13
pixel plus link 16
power 25
preferences 16
product specifications 25

R
rearrange channels 19
reception 27, 18
recycle 4
register product 5
remote control
batteries 25, 4
overview 5
technical specifications 25
rename channels 19
reorder channels 19
resolution 25
restore default 17

S
safety 3
screen care 4
settings
picture 10
sound 11
shop mode 16
skip channels 19
slideshow
view 15
with music 15
smart picture 9
smart settings 9, 11
smart sound 11
software
version 16
sound settings 11
specifications 25
standby 7
switch
channels 7
on and off 7
source 8

T
technical specifications 25
timer
on timer 12, 13
sleep timer 12
standby 12

transmission	25, 27
transporting	3
troubleshooting	27
TV lock	
lock channels	13
lock connected devices	13
PIN code	13
TV overview	5

U

USB	
disconnect USB	16
listen to music	15
update software	16
view photos	15

V

video format	
technical specifications	25
volume	
adjust	8
automatic leveling	11
delta	11
mute	8, 24

W

wall mount	3, 26
-------------------	-------

Artefacto:

Modelo:

**Fabricante/Importador: Philips Argentina S.A.
y/o Fábrica Austral de Productos Eléctricos S.A.
Dirección: Vedia 3892 - Buenos Aires**

Fecha de Venta:

--

Nro. de serie

Firma y sello de la casa vendedora.

PHILIPS ARGENTINA S.A. en adelante denominada “la empresa”, garantiza al comprador de este artefacto por el término de (1) año a partir de la fecha de adquisición, el normal funcionamiento contra cualquier defecto de fabricación y/o vicio de material, y se compromete a reparar el mismo —sin cargo alguno para el adquirente— cuando el mismo fallare en situaciones normales de uso y bajo las condiciones que a continuación se detallan:

1. Este certificado de garantía es válido únicamente en la República Argentina. El certificado debe ser completado por la casa vendedora y ser presentado por el usuario conjuntamente con la factura original de compra.
2. Serán causas de anulación de esta garantía en los casos que corresponda:
 - 2.1. Uso impropio o distinto del uso doméstico.
 - 2.2. Exceso o caídas de tensión eléctrica que impliquen uso en condiciones anormales.
 - 2.3. Instalación y/o uso en condiciones distintas a las marcadas en el “Manual de instalación y uso” que se adjunta a esta garantía.
 - 2.4. Cualquier intervención al artefacto por terceros no autorizados por la empresa.
3. La garantía carecerá de validez si se observare lo siguiente:
 - 3.1. Enmiendas o raspaduras en los datos del certificado de garantía o factura.
 - 3.2. Falta de factura original de compra que detalle tipo de artefacto, modelo, número de serie y fecha que coincida con los del encabezamiento del presente certificado.
4. No están cubiertos por esta garantía los siguientes casos:
 - 4.1. Los daños ocasionados al exterior del gabinete.
 - 4.2. Las roturas, golpes, caídas o rayaduras causadas por traslados.
 - 4.3. Los daños o fallas ocasionados por deficiencias, sobretensiones, descargas o interrupciones del circuito de alimentación eléctrica o rayos, deficiencias en la instalación eléctrica del domicilio del usuario o conexión del artefacto a redes que no sean las especificadas en el Manual de Uso del mismo.
 - 4.4. Las fallas, daños, roturas o desgastes producidos por el maltrato o uso indebido del artefacto y/o causadas por inundaciones, incendios, terremotos, tormentas eléctricas, golpes o accidentes de cualquier naturaleza.
 - 4.5. Las fallas o daños ocasionados en desperfectos en la línea telefónica.
 - 4.6. Las fallas producidas por una mala recepción ocasionada en el uso de una antena deficiente o en señales de transmisión débiles.
5. Las condiciones de instalación y uso del artefacto se encuentran detalladas en el Manual de Uso del mismo.
6. La empresa no asume responsabilidad alguna por los daños personales o a la propiedad al usuario o a terceros que pudieran causar la mala instalación o uso indebido del artefacto, incluyendo en este último caso a la falta de mantenimiento.
7. En caso de falla, el usuario deberá requerir la reparación a la empresa a través del Service Oficial y/o Talleres Autorizados más próximos a su domicilio y cuyo listado se acompaña al presente. La empresa a segura al usuario la reparación y/o reposición de piezas para su correcto funcionamiento en un plazo no mayor a 30 días contados a partir de la fecha de solicitud de reparación, salvo caso fortuito o fuerza mayor.

8. Toda intervención del servicio técnico realizada a pedido del usuario dentro del plazo de garantía, que no fuera originada por falla o defecto alguno cubierto por este certificado, deberá ser abonado por el interesado de acuerdo a la tarifa vigente.
9. El presente certificado anula cualquier otra garantía implícita o explícita, por la cual y expresamente no autorizamos a ninguna otra persona, sociedad o asociación a asumir por nuestra cuenta ninguna responsabilidad con respecto a nuestros productos.
10. En caso de que durante el período de vigencia de esta garantía el artefacto deba ser trasladado a las Delegaciones Oficiales y/o Talleres Autorizados de Service para su reparación, el transporte será realizado por la empresa y serán a su cargo los gastos de flete y seguros y cualquier otro que deba realizarse para su ejecución.



PHILIPS

Red de Talleres Autorizados

CAPITAL FEDERAL

ATTENDANCE S.A.

- Av. Monroe 3351 (1430) Capital Federal
- Tel.: 4545-5574/0704
- Ventas de Repuestos y Accesorios
- Tel.: 4545-0854

ELECTARG

- Av. Córdoba 1357 - (1055) Cap. Fed.
- Tel.: 4811-1050
- Ventas de Repuestos y Accesorios

GRAN BUENOS AIRES

Avellaneda	Torres Juan Carlos	Av. Mitre 2559	4255-5854
Florencio Varela	Torres Juan Carlos	San Martín 2574	4255-5854
Gregorio de Laferrere	Alvarez Corral Manuel	Honorio Luque 6084	4626-1322
Lomas de Zamora	Attendance S.A.	Laprida 485	4292-8900
Merlo	Argentronica S.H.	Pte. Cámpora 2175	(0220) 4837177/4829934
Morón	Servitronic (Ballesteros)	Ntra. Sra. del Buen Viaje 1222	4627-5656
Olivos	Appliance	Av. Libertador 2684	4794-7700
Quilmes	Torres Juan Carlos	E. Ríos esq. Gran Canaria	4255-5854
San Fernando	Bonelli Miguel Alberto	General Pinto 1252	4744-7240
San Miguel	Paz Marcelo	Belgrano 999	4664-4131
Villa Ballester	Servitronic (Ballesteros)	José Hernández 3101	4767-2515

CATAMARCA

Catamarca	Omicron	San Martín 225	(03833) 427235
-----------	---------	----------------	----------------

CHACO

Resistencia	Bonacorsi Mario Evaristo	Vedia 412	(03722) 420504
Resistencia	Freschi Jorge Oscar	Av. Avalos 320	(03722) 426030

CHUBUT

Comodoro Rivadavia	Monticelli Víctor Carlos	Alem 264	(0297) 4442629
--------------------	--------------------------	----------	----------------

CORDOBA

Córdoba	Servelco S.R.L.	Pje. E. Marsilla 635	(0351) 4724008/4732024
Córdoba	Electarg S.R.L.	Avenida Colón 544	(0351) 4255999
Río Cuarto	Maurutto Víctor G.	Bv. Almafuerde 487	(0358) 4660204
Río Tercero	Robotti Víctor	Homero Manzi 149	(03571) 423330
San Francisco	Acuña Walter	M. Moreno 360	(03564) 425367
Villa María	Grasso Eduardo	Bv. Alvear 541	(0353) 4521366
Villa María	Rúa Alejandro	Bv. Alvear 221	(0353) 4532951

CORRIENTES

Corrientes	Alonso Gerardo	Salta 1197	(03783) 466791
Paso de los Libres	Hantouche José	A. Bompland 1090	(03772) 425021
Goya	Quinodoz Carlos M.	José Gomes 1126	(03777) 432402

Caballito	Digi Tronic	Av. San Martín 1762	4583-1501
-----------	-------------	---------------------	-----------

BUENOS AIRES

Azul	Herlein Raúl Horacio	Av. 25 de Mayo 1227	(02281) 428719
Bahía Blanca	Ortiz Osvaldo Raúl	Soler 535	(0291) 4535329
Junín	Gualberto Marcelo	Alsina 537	(02362) 442754
La Plata	Da Tos Virgilio	Calle 68 N° 1532	(0221) 4516021
La Plata	Lasistec (S.I. La Plata)	Calle 11 N° 1161	(0221) 4217961
Mar de Ajó	Piqué Jorge Roberto	Catamarca 16	(02257) 421750
Mar del Plata	Central Service	Olazábal 2249	(0223) 4721639
Mar del Plata	Iglesias Miguel Angel	Diag. Pueyrredón 3229	(0223) 4945633
Moreno	Argentronica S.H.	Bmé. Mitre 2977 loc.2	(0237) 4639500
Necochea	Leal Carlos	Calle 64 N° 3217	(02262) 430996
Olavarría	Mocorich Juan Antonio	Alsina y Alvaro Barros	(02284) 427974
Pehuajó	Calcagni Carlos Alberto	Zubiría 794	(02396) 472665
Pergamino	Campos Otamendi Alberto	Dr. Alem 758	(02477) 421177
San Nicolás	Presutti José Luis	Bv. Alvarez 148	(03461) 454729
San Pedro	Menisale Alberto	Mitre 1695	(03329) 425523
Tandil	Lazzarini Oscar Rafael	Pellegrini 524	(02293) 442167
Tres Arroyos	Saini Fabián y Sergio	Av. Belgrano 562	(02983) 427369
Zárate	Spinozzi, Julio	Ituzaingó 1030	(03487) 427353
Trenque Lauquen	Labruno	San Martín 426	(02392) 423248

ENTRE RIOS

Concordia	Dalzotto Jorge	Humberto Primo 834	(0345) 4219233
Gualeguaychú	Kroh Adalberto Rubén	Santiago Díaz 22	(03446) 428380

FORMOSA

Formosa	Vallejos Rogelio Ramón	Mitre 276	(03717) 435985
---------	------------------------	-----------	----------------

JUJUY

Jujuy	Sandoval Raúl Antonio	Av. P. Marshke 528	(0388) 4256847
-------	-----------------------	--------------------	----------------

LA PAMPA

General Pico	Electrónica M.D.	Calle 20 N° 370	(02302) 425047
Santa Rosa	Tecnocyf Electrónica	Av. Roca 179	(02954) 426836

MENDOZA

Mendoza	Bonadeo Eduardo A.	Juan B. Justo 595	(0261) 4241111
San Rafael	Di Geronimo José A.	Av. Mitre 575	(02627) 425620 int. 11

MISIONES

El Dorado	Pastori Daniel (tele-son)	Polonia 24	(03751) 424014
Monte Carlo	Pastori Daniel	Av. Libertador 1204	(03751) 480311
Posadas	Fouce Juan Carlos	Av. Mitre 1866	(03752) 425921

NEUQUEN

Neuquén	Capdevila Ana M. (Tevesur)	Fotheringham 110	(0299) 4430679
---------	----------------------------	------------------	----------------

SALTA

Salta	Galland Roque Alberto	Alvarado 1066	(0387) 4317256
-------	-----------------------	---------------	----------------

SAN JUAN

San Juan	King Electrónica	Mendoza 802 (Sur)	(0264) 4228918
----------	------------------	-------------------	----------------

SAN LUIS

Villa Mercedes	Ciancia Eduardo Rubén	L. Guillet 380	(02657) 423990
San Luis	Rizzotto Carlos Antonio	Maipú 698	(02652) 428747

SANTA CRUZ

Río Gallegos	Vivar Héctor	Alberti 267	(02966) 422168
--------------	--------------	-------------	----------------

SANTA FE

Rafaela	Forni Horacio María	Sgto. Cabral 104	(03492) 426823
Reconquista	Sponton Alfredo	Habbergger 1516	(03482) 421523
Rosario	Allaria Service S.R.L.	Pte. Roca 371	(0341) 4401598
Rosario	SIP S.R.L.	España 470	(0341) 4252625 ó 4258180
San Jorge	Mandrile Alcides	H. Yrigoyen 1543	(03406) 440513
Santa Fe	Litoral Service S.R.L.	9 de Julio 2785	(0342) 4533563
Venado Tuerto	Degiovanni Adalberto Juan	Av. Hipólito Yrigoyen 1289	(03462) 424613

SANTIAGO DEL ESTERO

Santiago del Estero	Barchini Raúl Enrique	Rivadavia 833	(0385) 4213872
---------------------	-----------------------	---------------	----------------

TIERRA DEL FUEGO

Río Grande	Mojan Jorge O.	Laserra 670	(02964) 422566
------------	----------------	-------------	----------------

TUCUMAN

Tucumán	Albo Roque (Edu-Mag)	M. Avellaneda 129	(0381) 4229078
---------	----------------------	-------------------	----------------

PARAGUAY

Asunción	Serviphil	Av. Eusebio Ayala 4181	00595 21 503917
Ciudad del Este	Audio & Video	P. de la Patria c/Av. Caballero	(061) 502962
Concepción	Electrónica Concepción	Presidente Franco 284	(031) 40960
Encarnación	M'S Service Store	Villarrica 472	(071) 202616

URUGUAY

Montevideo	C.E.V.	Uruguay 1325	(005982) 901-1212
Montevideo	Makirey S.A.	18 de Julio 2302	(005982) 408-1770

03TA09

Para realizar consultas sobre este producto, Ud. puede comunicarse con el Centro de Atención al Cliente:

ARGENTINA
Tel.: 4544-2047
Fax: 4545-2928

PARAGUAY
Tel.: 009-800-54 1 0004
(Número gratuito)

URUGUAY
Tel.: 0004-054 176
(Número gratuito)

Dirección de mail:
customerphilips@philips.com.ar