

Register your product and get support at

6000 Series

www.philips.com/welcome

User manual

คู่มือผู้ใช้

Tài liệu hướng dẫn sử dụng

PHILIPS

Contents

1	Caution	2
2	Important	3
3	TV Overview	5
	Control Panel	5
	Remote Control	6
	Remote Control Usage	7
4	Use Your TV	7
	Switch on/off the TV or switch it to standby	7
	Watch content on connected devices	8
	Switch channels	8
	Adjust TV volume	9
5	Use More Functions	9
	Access to the TV menu	9
	Change Language	10
	Change picture settings	10
	Change sound settings	11
	EPG Usage	11
	Recording Menu	12
	Use Philips EasyLink	12
	Use EDID	12
	Use Timer	12
	Change the preferred TV settings	13
	Quick Boot	13
	Software Update	13
6	Media Center	14
	Play media files from USB device connected to TV	14
	Remove USB Storage Device	15
7	Set Channels	15
	Automatic Channel Searching	15
	Manual Channel Setting	15
	Search Digital Channels	16
8	Network Setup	16
	Switch on/off Smart TV	16
	Network Type	17
	Cable Installation	17
	Wireless Network Installation	17
	Screen Sharing	17
9	Product information	18
	Display resolutions	18
	Multimedia	18
	Sound power	18
	Inherent resolution	18
	Tuner / Reception / Transmission	19
	Remote Control	19
	Power Supply	19
	Supported TV mounts	19
10	Troubleshooting	19
	General issues	19
	Channel issues	19
	Picture issues	20
	Sound issues	20
	HDMI connection issues	20
	Computer connection issues	20
	Network Connection Issues	21
	Contact us	21
11	Open Source	21
	Open source software	21
	Open source license statement	21

1 Caution

2017©TPVision Europe B.V. All rights reserved. Specification is subjected to change without notice. Trademarks are the property of Koninklijke Philips N.V or their respective owners. TPVision Europe B.V. reserves the right to change products at any time without being obliged to adjust earlier supplies accordingly. The material in this manual is believed adequate for the intended use of the system. If the product, or its individual modules or procedures, are used for purposes other than those specified here in, confirmation of their validity and suitability must be obtained. TPVision Europe B.V. warrants that the material itself does not infringe any United States patents. No further warranty is expressed or implied. TPVision Europe B.V. cannot be held responsible neither for any errors in the content of this document nor for any problems as a result of the content in this document. Errors reported to Philips will be adapted and published on the Philips support website as soon as possible.

Terms of warranty

- Risk of injury, damage to TV or void of warranty! Do not attempt to repair the TV yourself.
- Use the TV and accessories only as intended by the manufacturer.
- The caution sign printed on the back of the TV indicates risk of electric shock. Never remove the TV cover. Always contact Philips Customer Support for service or repairs.



Any operation expressly prohibited in this manual, or any adjustments and assembly procedures not recommended or authorized in this manual shall void the warranty.

Pixel characteristics

This LCD/LED product has a high number of color pixels. Although it has effective pixels of 99.999% or more, black dots or bright points of light (red, green or blue) may appear constantly on the screen. This is a structural property of the TV (within common industry standards) and is not a malfunction.

Main fuse(/56)

This TV is fitted with an approved moulded plug. Should it become necessary to replace the main fuse, this must be replaced with a fuse of the same value as indicated on the plug (example 10A).

1. Remove fuse cover and fuse.
2. The replacement fuse must comply with BS 1363 and have the ASTA approval mark. If the fuse is lost, contact your dealer in order to verify the correct type.
3. Refit the fuse cover.

Copyright



The terms HDMI and HDMI High-Definition Multimedia Interface, and the HDMI Logo are trademarks or registered trademarks of HDMI Licensing Administrator, Inc. in the United States and other countries.

2 Important

Read and understand all instructions before you use your TV. If damage is caused by failure to follow instructions, the warranty does not apply.

Safety

Risk of electric shock or fire!

- Never expose the TV to rain or water. Never place liquid containers, such as vases, near the TV. If liquid is spilt on or into the TV, disconnect the TV from the power outlet immediately. Contact Philips Consumer Care to have the TV checked before use.
- Never place the TV, remote control or batteries near naked flame or other heat sources, including direct sunlight. To prevent the spread of fire, keep candles or other flames away from the TV, remote control and batteries at all times.



- Never insert objects into the ventilation slots or other openings on the TV.
- When the TV is swivelled ensure that no strain is exerted on the power cord. Strain on the power cord can loosen connections and cause arcing.
- To disconnect the TV from the mains power, the power plug of the TV must be disconnected. When disconnecting the power, always pull the power plug, never the cord. Ensure that you have full access to the power plug, power cord and outlet socket at all times.

Risk of short circuit or fire!

- Never expose the remote control or batteries to rain, water or excessive heat.
- Avoid force coming onto power plugs. Loose power plugs can cause arcing or fire.

Risk of injury or damage to the TV !

- Two people are required to lift and carry a TV that weighs more than 25 kg or 55 lbs.

- When stand mounting the TV, use only the supplied stand. Secure the stand to the TV tightly. Place the TV on a flat, level surface that can support the combined weight of the TV and the stand.
- When wall mounting the TV, use only a wall mount that can support the weight of the TV. Secure the wall mount to a wall that can support the combined weight of the TV and wall mount. TP Vision Europe B.V. bears no responsibility for improper wall mounting that results in accident, injury or damage.
- If you need to store the TV, disassemble the stand from the TV. Never lay the TV on its back with the stand installed.
- Before you connect the TV to the power outlet, ensure that the power voltage matches the value printed on the back of the TV. Never connect the TV to the power outlet if the voltage is different.
- Parts of this product may be made of glass. Handle with care to avoid injury and damage.

Risk of injury to children!

Follow these precautions to prevent the TV from toppling over and causing injury to children:

- Never place the TV on a surface covered by a cloth or other material that can be pulled away.
- Ensure that no part of the TV hangs over the edge of the surface.
- Never place the TV on tall furniture (such as a bookcase) without anchoring both the furniture and TV to the wall or a suitable support.
- Educate children about the dangers of climbing on furniture to reach the TV.

Risk of swallowing batteries!

- The product/remote control may contain a coin-type battery, which can be swallowed. Keep the battery out of reach of children at all times!

Risk of overheating!

- Never install the TV in a confined space. Always leave a space of at least 4 inches or

10 cm around the TV for ventilation. Ensure curtains or other objects never cover the ventilation slots on the TV.

Risk of injury, fire or power cord damage!

- Never place the TV or any objects on the power cord.
- Disconnect the TV from the power outlet and antenna before lightning storms. During lightning storms, never touch any part of the TV, power cord or antenna cable.

Risk of hearing damage!

- Avoid using earphones or headphones at high volumes or for prolonged periods of time.

Low temperatures

- If the TV is transported in temperatures below 5°C or 41°F, unpack the TV and wait until the TV temperature matches room temperature before connecting the TV to the power outlet.

Screen care

- Avoid stationary images as much as possible. Stationary images are images that remain on-screen for extended periods of time. Example: on-screen menu, black bar and time display. If you must use stationary images, reduce screen contrast and brightness to avoid screen damage.
- Unplug the TV before cleaning.
- Clean the TV and frame with a soft, damp cloth. Never use substances such as alcohol, chemicals or household cleaners on the TV.
- Risk of damage to the TV screen! Never touch, push, rub or strike the screen with any object.
- To avoid deformations and color fading, wipe off water drops as soon as possible.

Recycling



Your product is designed and manufactured with high quality materials and components, which can be recycled and reused.



When this crossed-out wheeled bin symbol is attached to a product it means that the product is covered by the European Directive 2002/96/EC. Please inform yourself about the local separate collection system for electrical and electronic products.

Please act according to your local rules and do not dispose of your old products with your normal household waste.

Correct disposal of your old product helps to prevent potential negative consequences for the environment and human health.



Your product contains batteries covered by the European Directive 2006/66/EC, which cannot be disposed of with normal household waste. Please inform yourself about the local rules on separate collection of batteries because correct disposal helps to prevent negative consequences for the environment and human health.

Environmental Protection Use Period



This logo labelled on the product itself indicates that the Environmental Protection Use Period thereof is 10 years.

The Environmental Protection Use Period of electrical information products refers to the time period during which the toxic and

hazardous substances or elements contained within the product will not leak or suddenly spoil, and users of such products will not cause any serious environmental pollution or serious damage to human and property. During the Environmental Protection Use Period, please use this product according to the instructions given in this user manual. The Environmental Protection Use Period does not cover consumable parts: the battery.

Suggestive description of the Recycling Administrative Regulations for Waste Electrical and Electronics Products

In order to care and protect the Earth in a better way, please adhere to the national and applicable laws in relation to the recycling management of waste electrical and electronics products when the user no longer needs to use this product, or when it has reached the end of its product life.

3 TV Overview

Congratulations on your purchase and use of Philips product! In order to fully enjoy the support provided by Philips, please register your TV at the following website: www.philips.com/welcome. (The following machine pictures are used for reference only. Please refer to the actual product.)

Control Panel

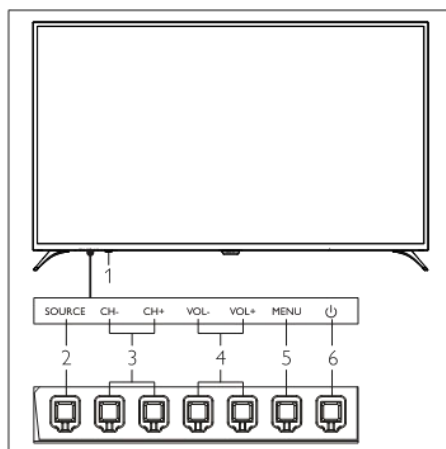

1. Indicator/remote signal receiving window.
2. SOURCE: press it to display the list of various sources.
3. CH+/CH-: switch to the previous or next channel.
4. VOL+/VOL-: increase or decrease volume.
5. MEMU: open or close menu.
6. : Turn on or off the product. Be sure to unplug the power plug to completely turn off the product.

Remote Control

Top

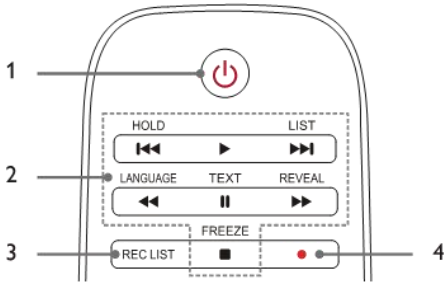

1. **Standby-Power on**
 - Switch the TV to standby if it is on.
 - Power on the TV if it is in standby state.
2. **Multimedia play buttons**
Control multimedia playback: "Previous", "Play", "Next", "REW", "Pause", "FF", and "Stop".
3. **REC LIST**
View the list of recordings.
4. **PVR recording function key.**

Middle

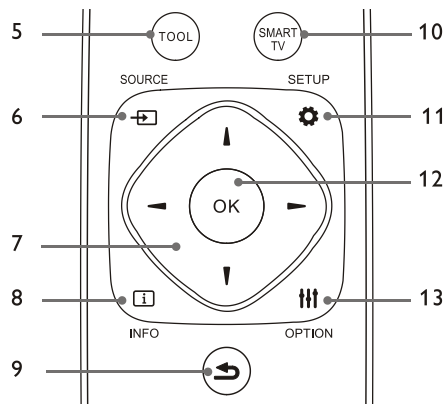

5. **TOOL**
Shortcut tool use to set the relevant items of the machine.

6. **SOURCE**
Select the input source of TV.
7. **Navigation key:** you can select the items in the setting function list.
8. **INFO**
View program information and return to the previous channel or exit the current menu.
9. **Back**
Return to the previous channel or exit the current menu.
10. **SMART TV**
Enter the main interface of smart TV.
11. **SETUP**
Open or close the setup menu.
12. **OK**
 - Confirm an operation.
 - In TV mode, press this key show channel list.
13. **OPTION**
 - Show menu functions.
 - Access to the options related to the current activities or selection.

Bottom

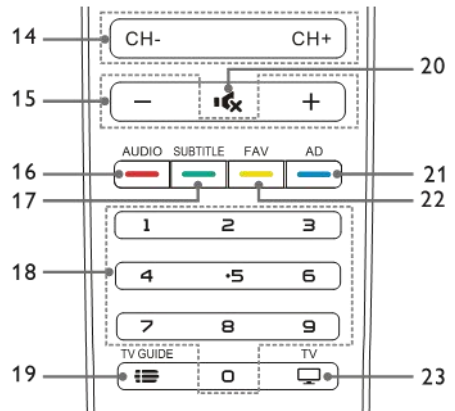

14. **CH+/CH-**
Switch to the previous or next channel.
15. **+/-**
Increase or decrease volume.

16. **AUDIO**
Nicam function.
17. **SUBTITLE**
Display subtitle message when the current channel has subtitle option.
18. **0~9 numeric keys**
Select a channel or input channel number.
19. **TV GUIDE**
Program guide.
20. **Mute**
Mute or unmute the sound.
21. **AD**
Turn on/off AD volume.
22. **FAV**
Display the favorite list.
23. **TV**
Switch to the TV function.

Remote Control Usage

When you use the remote control, hold it close to the TV and point it at the remote control sensor. Make sure that the line-of-sight between the remote control and TV is not blocked by furniture, walls or other objects.

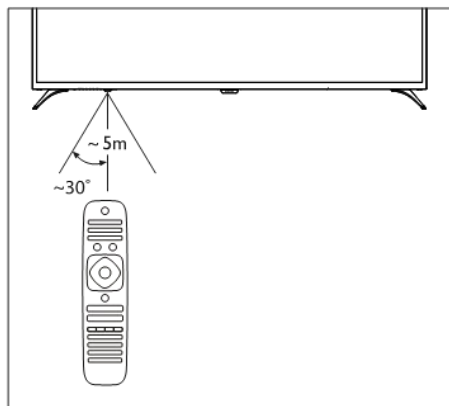

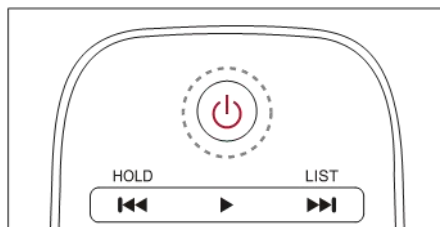
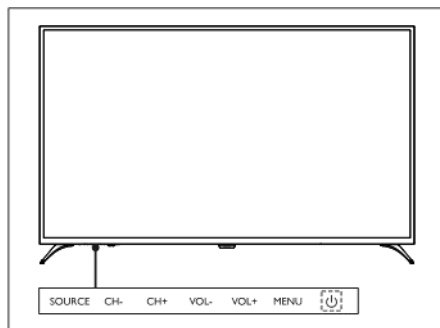
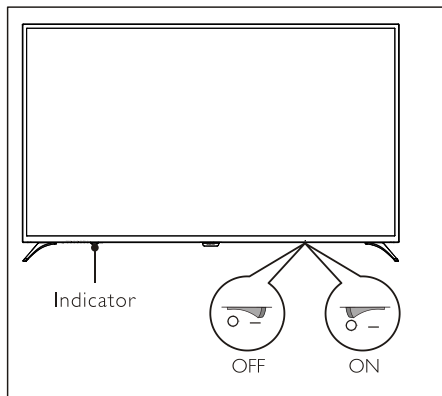

4 Use Your TV

Switch on/off the TV or switch it to standby



Switch on the TV.

- If the indicator is off, plug the TV power cable into the power socket. Press the on-off key of the TV to the ON state as shown in the figure.
- If the indicator is turned on, please press 

(Standby-On) on the remote control or  key on the TV.

Switch the TV to standby if it is on.

- Press  (Standby-On) on the remote control. The “Standby” indicator is turned on.

Switch off the TV.

- Press the on-off key on the back of the TV to the OFF state shown in the figure. The “standby” indicator is turned off.



Tip

- Though the TV consumes very little power when in standby mode, energy continues to be consumed. Disconnect the TV power cable from the power outlet when the TV is not used for an extended period of time.

Watch content on connected devices



Note

- Switch on the device before selecting it as an external source.

Use the Source button

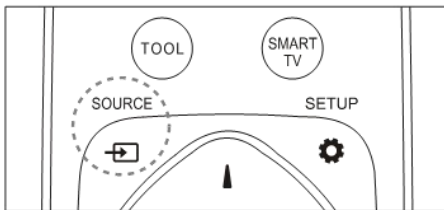

1. Press **SOURCE** key. The source list appears.
2. Press **▲/▼** key to select a device.
3. Press **OK** key. The TV switches to the selected device.

Switch channels

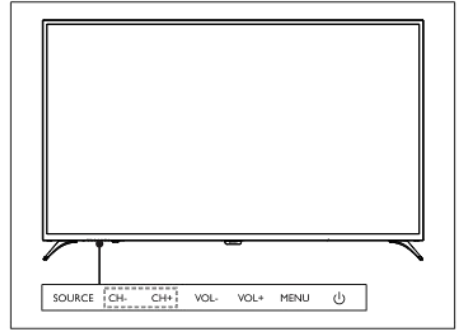

Switch channels without Using Channel list:

- Press **CH+/CH-** key on the TV or the remote control.
- Enter a channel number using the numeric buttons on the remote control.
- Press the  (Back) key on the remote control to return to the previous channel.

Switch channels Using Channel list:

You can use the channel list to watch all available channels.

1. Press **OK** key. The channel list appears.
2. Press **▲/▼** key to select a channel.
3. Press **OK** key to watch the selected channel.
4. Press the  (Back) key to switch to the previously watched channel.

Adjust TV volume

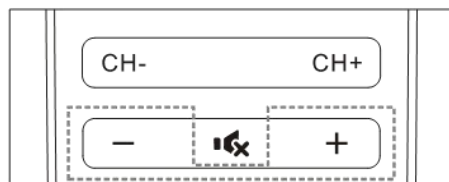
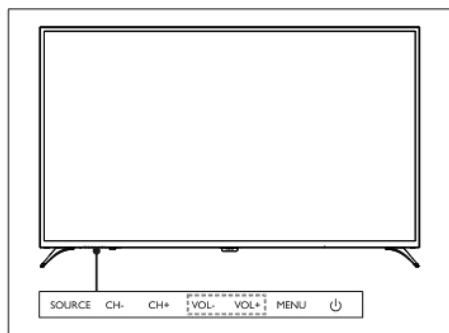

Increase or decrease volume.

- Press the **VOL+/VOL-** key on the TV or the **+/-** key on the remote control.

Mute or unmute the sound.

- Press **MUTE** key to mute.
- Press **MUTE** key again to restore the sound.

5 Use More Functions

Access to the TV menu

The function list helps to set channels, change pictures, and set audio and other functions.

1. Press **⚙️** key. Open the Setting menu.

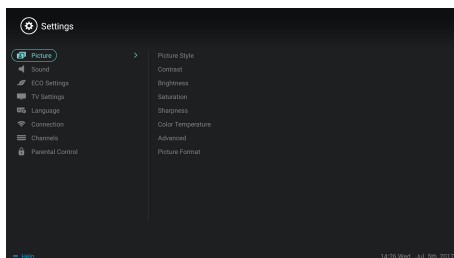

2. Press **▲/▼** key to select one of the following options; then press **OK**.
 - **Picture:** apply the predefined picture setting option.
 - **Sound:** apply the predefined sound setting option.
 - **ECO Setting:** set screen backlight display **items**.
 - **TV Setting:** set TV function items.
 - **Language:** set the menu language, keyboard and input method.
 - **Connection:** set wired network connection and wireless network connection.
 - **Channels:** set channel searching.
 - **Parental control:** this function helps parents to set channels available for children of different age groups.





Note

- The settings vary with input sources.

Change Language

You can change the menu language.

1. Press  key to select language>menu language; then press  key.
2. Select your needed language and then press **OK** key.

Change picture settings

You can change picture settings to your preferred settings by applying predefined settings or manually modifying settings.

Quick picture setting

You can set up picture quickly using this function.

1. Press  key to select picture; and then press **OK** key.
2. Select your preferred settings according to the instructions on the screen.

Picture style

Apply the predefined picture style setting.

1. Press  key to select picture mode.
2. Select one of the following settings and then press **OK** key.
 - Vivid: apply the color dynamic setting suitable for watching during daytime.
 - Standard: adjust the picture setting to suit most video environments and types.
 - Natural: set natural mode.
 - Personal: use the self-defined picture setting.

Manually adjust picture settings

1. Press  key to select picture; and then press **OK** key.
2. Select one of the following settings and then press **OK** key.
 - Contrast: adjust contrast and increase the light intensity difference between the bright part and the dark part.
 - Brightness: adjust the light intensity and fineness of the darker area.

- Saturation: adjust color saturation.
- Sharpness: adjust image definition.
- Color temperature: adjust the overall image color temperature.
- Advanced settings:
 - Noise reduction; filter and reduce the noisy points in the image.
 - Auto adjustment: automatically adjust the PC display picture.
 - Picture shift : set your PC display picture, e.g. horizontal position, vertical position, clock and phase.

Change picture format

Press  key to select Picture>Picture format; then press  key.

Picture format

You can choose from the following picture formats.



Note

- Some picture settings may not be available for certain sources.



Subtitle zoom:

(This format is not applicable to HD mode and PC mode.) Display subtitles completely when the video source with subtitles is played, but part of the image on the top will be cropped.



4:3:

Display the picture in the traditional 4:3 picture format.



Movie Expand 16:9:

(This format cannot be applied to PC mode.) The picture format is adjusted from 4:3 to 16:9.



Wide screen:

The picture format is adjusted from 4:3 to 16:9.



Auto:

Automatically adjust the picture to an appropriate aspect ratio.

Change sound settings

You can change sound settings to your preferred settings by applying predefined settings or manually modifying settings.

Quick sound setting

You can set up sound quickly by applying predefined sound settings in Sound Style.

1. Press  key to select Sound; and then press **OK** key.
2. Select one of the following settings and then press **OK** key.
 - Sound mode:
 - Standard: it can be applied to most situations and sound sources.
 - News: it can be applied to speech (e.g. news).
 - Cinema: The sound setting for movies can be applied.
 - Personal setting: use self-defined sound settings.

Manually adjust sound settings

1. Press  key to select sound; and then press **OK** key.
2. Select one of the following settings and then press **OK** key.
 - 120Hz, 500Hz, 1.5KHz, 5KHz, 10KHz: adjust according to the sound frequency range of file or source.
 - Balance: adjust the balance of left and right loudspeakers.
 - Surround: turn on or off the surround sound function.

- Advanced setting: select PCM/RAW mode of SPDIF.
 - Hearing impaired: turn on or off the hearing impaired function.
 - AD switching: turn on or off AD switch.

EPG Usage

EPG is the electronic program guide provided on digital channels. With EPG, you can





- View the list of the currently broadcast digital programs.
- Watch the current transmitted program.
- Set up program reminder.

Turn on EPG (Program Guide)

Press the TV GUIDE key on the remote control to display the program list.



Note

- EPG cannot be turned on directly in non-digital TV mode.
- Press the green key  in the program guide to remind or cancel the program to be played within one week.
- Press the red key  to turn on the scheduled recording function: Automatic or manual is available. According to your preference, you can manually set recording time and mode.
- Press the yellow key  to display the program information on different dates.
- Press the blue key  to display the help instructions.

Recording Menu



Note

- Make sure that the USB storage device has been well connected.
- When parental control is activated, schedule recording may not be able to function properly.

Program recording

In digital TV mode, press **●** key to display the recorder menu on the screen and start program recording. Press the **◀/▶** key to select the operation menu and press **OK** key to confirm. During recording, you can press keys such as **▶**、**⏏**、**■** to carry out shortcut operation.

Use Philips EasyLink

With **Philips EasyLink** you can operate a connected device with the TV remote control. EasyLink uses **HDMI CEC** (Consumer Electronics Control) to communicate with the connected devices. Devices must support **HDMI CEC** and must be connected with an **HDMI** connection.

To enable **Philips EasyLink**, you need to:

- Compatible device can work normally.
- Switch to EasyLink.



Note

- The EasyLink compatible device must be turned on and selected as a source.
- Philips doesn't ensure 100% interoperability with all HDMI-CEC devices.

Turn on or off EasyLink



Note

- Do not enable Philips EasyLink if you don't intend to use it.

1. Press **⚙** key.
2. Select TV Settings > EasyLink > EasyLink.

3. Select OFF or ON and then press **OK** key.

Set HDMI-Audio Output

1. Press **⚙** key.
2. Select TV Settings > EasyLink > HDMI – Audio Output.
3. Select OFF or ON and then press **OK** key.

Use EDID

1. Press **⚙** key.
2. Select TV Settings > EDID Version and then press **OK** key to enter.
3. Select your needed version and then press **OK** key to confirm.



Tip

- EDID is a data structure provided by a digital display to describe its capabilities to a video source. This settings is valid only under HDMI source.
- HDMI EDID1.4 support to 3840x2160 30Hz.
- HDMI EDID2.0 support to 3840x2160 50Hz/60Hz, e.g. 4K Blu-ray Player.

Use Timer

You can use Timer so as to switch the TV to standby after the specified time.

Use Sleep Timer

Set the time when the TV is switched to standby.



Tip

- You can switch off the TV or reset the Sleep Timer before the timer reaches zero.

1. Press **⚙** key and then select TV Settings > Sleep Timer. The Sleep Timer is shown on the screen.
2. Set the timer to a value between 0 to 240 minutes. The increment of the Sleep Timer is

- 10 minutes. If the Sleep Timer is set to 0, it will be turned off.
3. Press **OK** key to turn on the Timer. The TV is switched to standby when reaching the preset time.

Change the preferred TV settings

1. Press **⚙️** key to select TV Settings.
2. Select one of the following and then press **OK** key.
 - Picture and Sound Reset: restore all TV picture and sound settings to the preset values.
 - EasyLink: set up EasyLink functions.
 - About the TV: show the TV related information.
 - Key Beep: turn on the key tone of the remote control. When you press a button on the remote control, the TV will make a sound.
 - Sleep Timer: switch the TV to sleep mode after the preset time.
 - Reinstall TV: restore your TV to default settings.
 - Shop Mode: choose to turn on or off Shop Mode.
 - Time Zone: set the time zone of TV.
 - PVR File System:
 - Select disk: Select the folder where you want to save the recording file.
 - Format start: format the external USB device.
 - Speed check: test the reading/writing speed of the USB device.
 - Software update (OAD): turn on/off software update (OAD).

Quick Boot

- Press **⚙️** key to select TV Settings > Quick Boot, and press **OK** key to enter. Press **▲/▼** key to select On to enable this function.

Quick Boot ON: Improve TV boot up sequence to reduce TV rebooting time.

- Press **⚙️** key to select TV Settings > Quick Boot, and press **OK** key to enter. Press **▲/▼** key to select Off to disable this function.

Software Update

Philips keeps improving our products. We suggest that you update TV software when a new version is launched.

Check the current software version

Press **⚙️** key to select TV Settings > About the TV > Current Software Info and then press **OK** key. The current software version information will show.

Software Update

You can update the software using the following methods:

- Connect to network for automatic update. Press **⚙️** key to select TV Settings > About TV > Auto Software Update and then press **OK** key. Update the software according to the instructions on the screen.
- Update the software using an USB storage device.
 1. Press **⚙️** key to select TV Settings > About TV > Manual Software Update and then press **OK** key. Update the software according to the instructions on the screen.
 2. Press **⚙️** key to select TV Settings > About TV > Local Update and then press **OK** key. Update the software according to the instructions on the screen.



Note

- Unplug the USB device after software is well updated.
- For software update, please use a USB device. The use of a hard disk may result in update failure and restarting due to insufficient power supply.

6 Media Center

You can play pictures, videos, music and other multimedia files in USB devices.

Play media files from USB device connected to TV

Note



- Supported storage device: make sure that USB has been connected.

1. Switch on the TV.
2. Connect a USB storage device to the USB port on the side of the TV.
3. Press  key to display the source menu.
4. Select the USB disk and then press **OK** key.
5. If there are multiple USB storage devices, select the desired USB storage device and then press **OK** key. The browser opens.

View pictures

1. Select a folder or a picture in the browse page and then press **OK** key.
2. Select a picture and then press **OK** key. Zoom in this picture to full screen.



- : Play/Pause lantern slide.
- : view the previous/next picture.
- : Return to the browser page.







Change slide play settings

Please press  key when playing slides. Display the list of slide play options and browse pictures according to the instructions on the screen.

Listen to music

Select a folder or music in the browser page and then press **OK** key to play. Change the music play settings according to the instructions on the screen.



- : Play/Pause music.
-  / : Fast Forward/Fast Backward.
-  / : Play the previous/next music.
- : Return to the browser page.
- : Set the music play mode.

Play music while watching slides

You can play background music while watching slides.

1. Select a music album.
2. Press **OK** key.
3. Press  key to return to the main screen of browser page.
4. Select a picture.
5. Press **OK** key to play slides.

Watch Videos

1. Select a folder or a video in the browser page.
2. Press **OK** key to play a video. Change the video play settings according to the instructions on the screen.



- ▶/|| : Play/Pause video.
|◀/▶| : Fast Forward/Fast Backward.
|◀/▶| : Play the previous/next video.
↶ : Return to the browser page.
⏸ : Set the video play options.

Remove USB Storage Device



Note

- Please remove a USB storage device according to the following steps to prevent damage.

1. Press **↶** key to return to or quit the main screen of browser page.
2. Wait for about 5 seconds and then remove the USB storage device.

7 Set Channels

For the initial setup, the system will remind you to select network connection or TV channel installation. The Section provides the instructions on how to reinstall and fine-tune channels.

Automatic Channel Searching

1. Press **⚙** key.
2. Select Channel > Channel Settings and then press **OK** key.
3. Press **OK** key to begin automatic channel searching.



Note

- This function can be used only in TV mode.

Manual Channel Setting

Step 1 Select System

1. Press **⚙** key.
2. Select Channel > Analog channel manual installation.
3. Choose to begin scanning and fine-tuning.



Note

- Frequency fine-tuning can be performed only when the source is ATV.

Step 2 Search and Store New Channels

1. Press **⚙** key.
2. Select Channel > Analog channel manual installation > Begin Scanning.
 - You can directly input the channel frequency.
 - Choose to Scan and then press **OK** key to begin scanning.
3. Upon searching completion, select Save to quit the current interface.
 - Save the searched channels.

Step 3 ATV Fine Tuning

1. Press **⚙️** key.
2. Select Channel > Analog channel manual installation > Fine-tuning.
3. Select Decrease or Increase to adjust the frequency.

Search Digital Channels

1. Press **⚙️** key.
2. Select Channel > Digital channel manual installation and then press **OK** key.
3. Directly input the channel frequency.
4. Choose Scan and then press **OK** key to begin scanning.

8 Network Setup

Switch on/off Smart TV

You can set the network so as to access to different networks.

1. Connect the TV to Internet. If there is no network connection, certain functions of the smart TV cannot work.
2. Press **SMART TV** button on the remote control. The picture automatically skips to Smart TV.

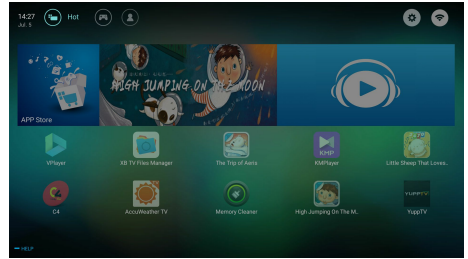

(The picture and the applications in it are for reference only!)

Applications

You can obtain apps from App store or manage installed apps, and quickly switch between hot apps and My Apps.

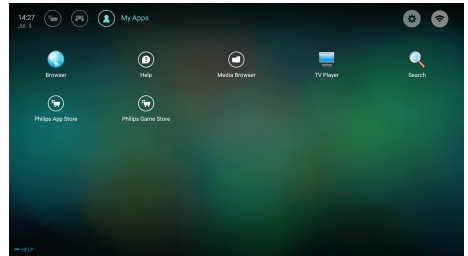



Note

- Some apps support only mouse operation.
- The memory space is not equal to available space.
- Philips reserves the right to add or delete some apps.
- Do not change the ROM of TV at random. Otherwise, any faults caused thereof are not within the warranty scope.

Network Type

You can select network setting type.

- Press key and then select Connection > Wired or Wi-Fi. To view MAC address, press key and then select Connection > Wired or Wi-Fi > View Network Settings.

Cable Installation

To needing to connect the TV to PC network or Internet, you need to install a route in the PC network. Use a network cable (Ethernet cable) to connect the route to the TV.

Connect the route to the network interface at the bottom of TV using a network cable, and turn on the route before network installation.

Wired Network Connection and Automatic Searching

1. Press key and then select Connection > Wired or Wi-Fi > Connect Network > Wired Network.
2. Select **DHCP** and then Connect and press **OK** key. The network protocol will be set automatically.

Wired Network Setting - Automatic Input

1. Press key and then select Connection > Wired or Wi-Fi > Connect Network > Wired Network.
2. Select static IP, press key, and place the cursor in the input box.
3. Use the remote control to input IP address, subnet mask, gateway, DNS1 and DNS2.
4. Upon input completion, select OK and then press **OK** key.

Wireless Network Installation

1. Press key and then select Connection > Wired or Wi-Fi > Connect Network > Wireless Network.
2. Select ON. The screen will show the current set network parameters and available wireless network.
3. Select Connect WPS, turn on the WPS function of the router, and press **OK** key to connect WPS network.

Screen Sharing

Multi-screen Interaction shows the contents on the mobile device screen on the TV screen and plays the sound on the mobile device in the TV speakers synchronously. Use the volume button on the remote control to control volume.



Note

- The multi-screen interaction function may not be compatible with some mobile devices.

Create Connection

1. Press key and then select Connection > Wired or Wi-Fi > Screen Sharing.
2. Select ON or OFF and then press **OK** key to confirm.
3. Use the WLAN/wireless display function on the mobile device to send a connection request. When it is connected successfully,

the picture on the mobile device will be transmitted to the TV screen.

Disconnection Mode

1. You can disconnect the mobile device during transmission.
2. Press  button on the remote control to disconnect during transmission.



Note

- The multi-screen interaction function can be used only when the Wi-Fi of the TV and mobile device is turned on.

9 Product information

Product information is subject to change without notice. For detailed product information, please visit www.philips.com/support.

Display resolutions

Computer Formats

- Resolution - refresh rate:
 - 640 × 480 60Hz
 - 800 × 600 60Hz
 - 1024 × 768 60Hz
 - 1360 × 768 60Hz
 - 1920 × 1080 60Hz

HDMI Video Formats

- Resolution - refresh rate:
 - 480i - 60Hz
 - 480p - 60Hz
 - 576i - 50Hz
 - 576p - 50Hz
 - 720p - 50Hz,60Hz
 - 1080i - 50Hz,60Hz
 - 1080p - 50Hz, 60Hz.
 - 2160p - 50Hz, 60Hz.

Multimedia

- Supported storage device: USB (NTFS, FAT or FAT 32. USB storage devices are supported.)
- Compatible multimedia file formats:
 - Image: JPEG
 - Audio: MP3
 - Video: MPEG 2/MPEG 4, H.264(FHD) , H.265

Sound power

- 50" : 8W × 2
- 55" : 8W × 2

Inherent resolution

- 50" : 3840 × 2160
- 55" : 3840 × 2160

Tuner / Reception / Transmission

- Aerial input: 75ohm coaxial (IEC75)
- Supported Systems:
ATV: PAL, SECAM, I, D/K, B/G, L
DTV: DVB-T/T2.

Remote Control

- Batteries: 2 × AAA

Power Supply

- Main Power Supply:
100-240V ~, 50/60Hz
- Standby Energy Consumption:
≤0.5W
- Environment Temperature: 5 - 40°C
- Power consumption:
 - 50": 130W
 - 55": 155W

Supported TV mounts

To mount the TV, please purchase a Philips TV mount or any TV mount compliant with the VESA standard. To prevent damage to cables and connectors, be sure to leave a clearance gap of at least 2.2 inches or 5.5cm between the back of the TV to the wall.



Warning

- Please follow all instructions provided with the TV mount. TP Vision Europe B.V. bears no responsibility for improper TV mounting that results in accident, injury or damage.

Model No.	Required Pixel Pitch (mm)	Required Mounting Screws
50"	200 × 200	4 × M6
55"	200 × 200	4 × M6

10 Troubleshooting

This section covers common problems and their accompanying solutions.

General issues

The TV cannot be switched on:

- Disconnect the power cable from the power outlet. Wait for one minute before reconnecting it.
- Check that the power cable is securely connected.

The remote control is not working properly:

- Check that the remote control batteries are correctly inserted according to the +/- orientation.
- Replace the remote control batteries if they are flat or weak.
- Clean the remote control and TV sensor lens.

The TV menu is in the wrong language:

- Change the TV menu to your preferred language.

When turning the TV On/Off or to Standby, you hear a creaking sound from the TV chassis:

- No action is required. The creaking sound comes from the normal expansion and contraction of the TV as it cools down and warms up. This does not impact its performance.

Channel issues

Previously installed channels do not appear in the channel list:

- Check that the correct channel list is selected.

Picture issues

The TV is on, but there is no picture:

- Check that the antenna is properly connected to the TV.
- Check that the correct device is selected as the TV source.

There is sound but no picture:

- Check that the picture settings are correctly set.

Poor TV reception from the antenna connection:

- Check that the antenna is properly connected to the TV.
- Loudspeakers, unearthed audio devices, neon lights, high buildings and other large objects can influence reception quality. if possible, try to improve the reception quality by changing the antenna direction or moving devices away from the TV.
- If the reception on one particular channel is poor, please fine tune this channel.

There is poor picture quality from connected devices:

- Check that the devices are connected properly.
- Check that the picture settings are correctly set.

The picture does not fit the screen; it is too big or too small:

- Try using a different picture format.

The picture position is incorrect:

- Picture signals from some devices may not fit the screen correctly. Please check the signal output of the device.

Sound issues

The pictures are showing but sound quality is poor:

- Check that all cables are properly connected.
- Check that the volume is not set to 0.
- Check that the sound is not muted.
- Check that the sound settings are correctly set.

The pictures are showing but sound comes from one speaker only:

- Verify that sound balance is set to the centre.

HDMI connection issues

There are problems with HDMI devices:

- Please note that HDCP (High-bandwidth Digital Content Protection) support can delay the time taken for a TV to TV content from a HDMI device.
- If the TV does not recognize the HDMI device and no picture is displayed, please try switching the signal source to another device before switching it back again.
- If there are intermittent sound disruptions, please check that output settings from the HDMI device are correct.

Computer connection issues

The computer display on the TV is not stable:

- Check that your PC uses the supported resolution and refresh rate.
- Set the TV picture format to unscaled.

Network Connection Issues

Failure to connect to the Internet:

- If the TV is correctly connected to the router, please check the connection between the router and the Internet.

Network speed is slow:

- Please refer to the instruction manual of your router to learn about the factors that may affect transfer rate and signal quality.
- You may need to upgrade your broadband speed.

Contact us

If you cannot resolve your problem, please refer to the FAQs for this model at www.philips.com/support.

If the problem remains unresolved, please contact your local Philips Customer Service Centre.



Warning

- Do not attempt to repair the TV yourself. This may cause severe injury, irreparable damage to your TV or void your warranty.



Note

- Please make a note of your TV model and serial number before you contact Philips Customer Service Centre. These numbers are printed on the back/bottom of the TV and on the packaging.

11 Open Source

Open source software

This television contains open source software. TP Vision Europe B.V. hereby offers to deliver, upon request, a copy of the complete corresponding source code for the copyrighted open source software packages used in this product for which such offer is requested by the respective license.

This offer is valid up to three years after product purchase to anyone in receipt of this information.

To obtain the source code, please write in English to .

.. open.source@tpvision.com

Open source license statement

Acknowledgments and License Texts for any open source software used in this Philips TV.

This is a document describing the distribution of the source code used on the Philips TV, which fall either under the GNU General Public License (the GPL), or the GNU Lesser General Public License (the LGPL), or any other open source license. Instructions to obtain source code for this software can be found in the user manual.

PHILIPS MAKES NO WARRANTIES WHATSOEVER, EITHER EXPRESS OR IMPLIED, INCLUDING ANY WARRANTIES OF MERCHANTABILITY OR FITNESS FOR A PARTICULAR PURPOSE, REGARDING THIS SOFTWARE. Philips offers no support for this software. The preceding does not affect your warranties and statutory rights regarding any Philips product(s) you purchased. It only applies to this source code made available to you.

U-Boot - Universal Bootloader (2010 06)
U-Boot, a boot loader for Embedded boards based on PowerPC, ARM, MIPS and several

other processors, which can be installed in a boot ROM and used to initialize and test the hardware or to download and run application code.

Source: <http://www.denx.de/wiki/U-Boot/>

udev – Userspace Device Management Daemon (164.0) This program creates the files for devices on a Linux system for easier management. udev is a program which dynamically creates and removes device nodes from /dev/. It responds to /sbin/hotplug device events and requires a 2.6 kernel.

Source: <https://launchpad.net/udev>

Util-Linux (2.22-rc2)

Source:

<https://www.kernel.org/pub/linux/utils/util-linux/>

Linux Kernel (3.10)

Real-Time Operating System

Source: <http://www.kernel.org/>

BusyBox (1.16.1)

BusyBox combines tiny versions of many common UNIX utilities into a single small executable. It provides replacements for most of the utilities you usually find in GNU fileutils, shellutils, etc. The utilities in BusyBox generally have fewer options than their full-featured GNU cousins; however, the options that are included provide the expected functionality and behave very much like their GNU counterparts. BusyBox provides a fairly complete environment for any small or embedded system.

Source: <http://busybox.net/>

Ext2 Filesystems Utilities (1.41.11)

The Ext2 Filesystem Utilities (e2fsprogs) contain all of the standard utilities for creating, fixing, configuring, and debugging ext2 filesystems.

Source:

<http://e2fsprogs.sourceforge.net/e2fsprogs-release.html#1.41.12>

GDB - The GNU Project Debugger (6.8)

GDB allows you to see what is going on "inside" another program while it executes - or what another program was doing at the moment it crashed. GDB can do four main kinds of things

(plus other things in support of these) to help you catch bugs in the act:

* Start your program, specifying anything that might affect its behavior. Make your program stop on specified conditions. * Examine what has happened, when your program has stopped.

* Change things in your program, so you can experiment with correcting the effects of one bug and go on to learn about another. The program being deb

Source: <https://www.gnu.org/software/gdb/>

genext2fs (1.4.1)

it generates an ext2 filesystem as a normal (i.e. non-root) user. It doesn't require you to mount the image file to copy files on it. It doesn't even require you to be the superuser to make device nodes or set group/user ids.

Source: <http://genext2fs.sourceforge.net/>

iPerf (2.0.5iPerf3 is a tool for active measurements of the maximum achievable bandwidth on IP networks. It supports tuning of various parameters related to timing, buffers and protocols (TCP, UDP, SCTP with IPv4 and IPv6). For each test it reports the bandwidth, loss, and other parameters. This is a new implementation that shares no code with the original iPerf and also is not backwards compatible.

Source: <http://iperf.fr/>

libnl - Netlink Library (2.0)

The libnl suite is a collection of libraries providing APIs to netlink protocol based Linux kernel interfaces.

Netlink is a IPC mechanism primarily between the kernel and user space processes. It was designed to be a more flexible successor to ioctl to provide mainly networking related kernel configuration and monitoring interfaces.

Source: <http://www.infradead.org/~tgr/libnl/>

Mem Tester (4.3.0)

A userspace utility for testing the memory subsystem for faults.

Source: <http://pyropus.ca/software/memtester/>

mtd-utils (1.5.0)

We're working on a generic Linux subsystem for memory devices, especially Flash devices. The

aim of the system is to make it simple to provide a driver for new hardware, by providing a generic interface between the hardware drivers and the upper layers of the system.

Source: <http://git.infradead.org/mtd-utils.git>

squashfs - a compressed fs for Linux (squashfs4.2) Squashfs is a highly compressed read-only filesystem for Linux. Squashfs compresses both files, inodes and directories, and supports block sizes up to 1Mbytes for greater compression. It is implemented as a kernel module underVFS.

Source: <http://sourceforge.net/projects/squashfs/>

Alsa Libraries (1.0.21)

linux standard audio application libraries

Source: <http://www.alsa-project.org>

Alsa Utils (1.0.21)

linux standard audio tool library

Source: <http://www.alsa-project.org>

Helix Realplay (1.0.5)

The Helix Player is an open source media player for Linux, Solaris, and Symbian based on the Helix DNA Client media engine. More operating system versions are currently in development.

Source: <https://helixcommunity.org/>

libjpeg (6b)

1.HiGO dependent (jpeg decoder)

2.DirectFb dependent (jpeg decoding)

Source: <http://ijg.org/>

libpng (1.4.0)

1.DirectFb dependent (PNG decoder)

2.HiGO dependent (PNG decoding)

Source: <http://github.com/jongwook/libpng/>

zlib (1.2.5)

A data compression algorithm , the compiler toolset mtd time required to use the zlib library

Source: <http://www.zlib.net/>

rp-pppoe (3.11)

Internet Dependence

Source:

<http://www.roaringpenguin.com/products/pppoe/>

ISC DHCP (4.1.1-P1)

Internet Dependence

Source: <https://www.isc.org/downloads/dhcp/>

Ffmpeg (0.1)

Development of media properties , the player must assembly

Source: <http://ffmpeg.org/>

Android - kernel - common (3.4)

Common Android Kernel Tree

Source:

<https://android.googlesource.com/kernel/common/>

Android (5.1.1_r1)

Android Operating System

Source:

<https://developer.android.com/index.html>

mali-400-kernel-drivers (master-20121127)

mali-400 kernel drivers for external compilation for use with linux-sunxi kernel.

Source:

<https://github.com/linux-sunxi/mali-400-kernel-drivers>

NFS- nfs-utils (1.1.2)

File system dependency

Source: <http://sourceforge.net/projects/nfs/>

coreutils (8.5)

The GNU Core Utilities are the basic file, shell and text manipulation utilities of the GNU operating system. These are the core utilities which are expected to exist on every operating system.

Source: <http://www.gnu.org/software/coreutils/>

dosfstools (3.0.25)

Source:

<http://daniel-baumann.ch/software/dosfstools/>

Samba (3.5.11)

Internet Dependence

Source: <https://www.samba.org/samba/>

Arp Scan (1.8.4)

Internet Dependence

Source:

<http://www.nta-monitor.com/tool-sresources/security-tools/arp-scan>



All registered and unregistered trademarks are property of their respective owners. Specifications are subject to change without notice. Philips and the Philips' shield emblem are trademarks of Koninklijke Philips N.V. and are used under license from Koninklijke Philips N.V.

2017 ©TPVision Europe B.V. All rights reserved.
philips.com

