

Register your product and get support at
www.philips.com/welcome

6600 series - Smart LED TV

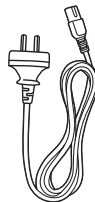

(AU)

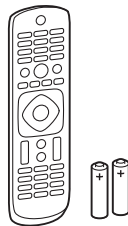
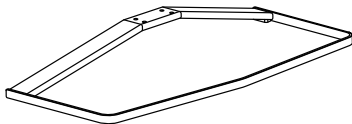
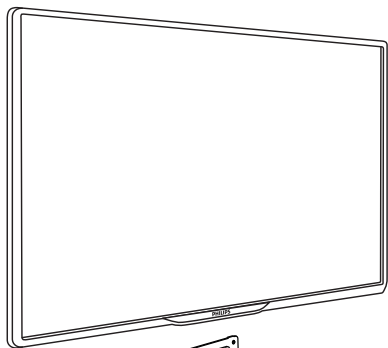
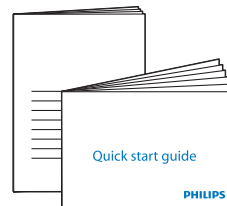
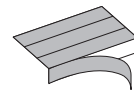

PHILIPS

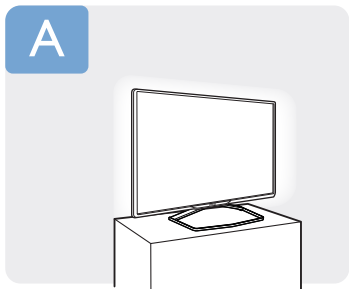

p.3

or

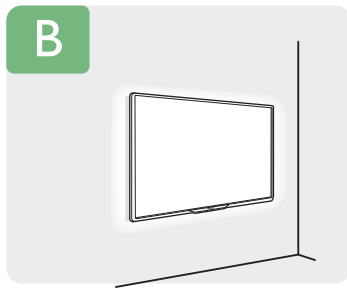

p.5



- English** Read the safety instructions.
- Bahasa Indonesia** Bacalah petunjuk keselamatan.
- ภาษาไทย** อ่านคำแนะนำด้านความปลอดภัย
- Tiếng Việt** Đọc hướng dẫn an toàn.
- 简体中文** 请阅读安全说明。
- العربية** قراءة تعليمات السلامة.

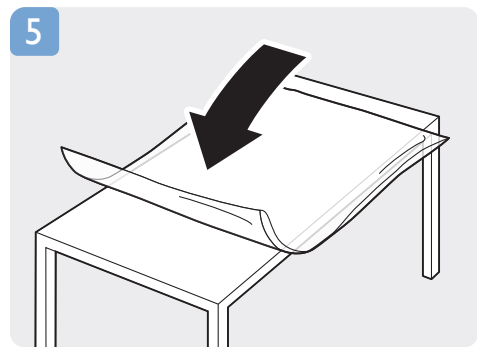
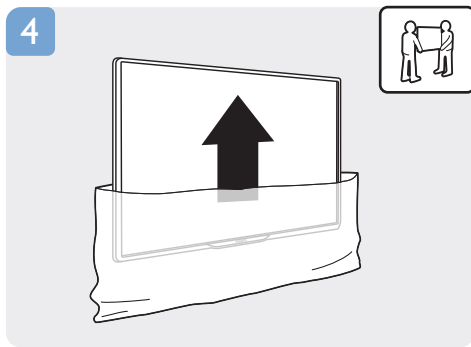
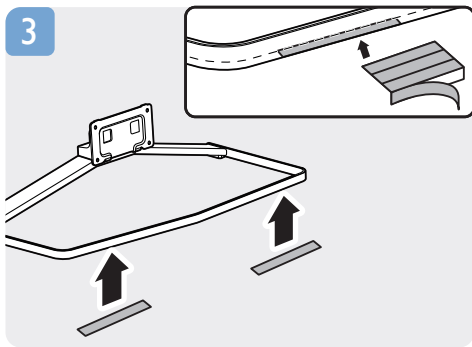
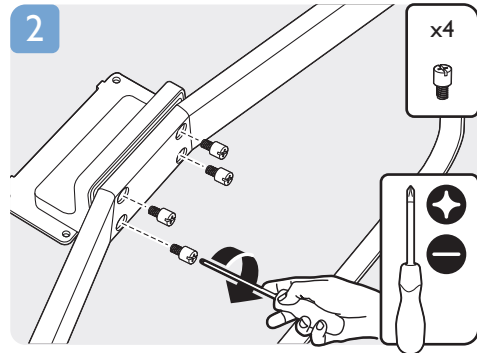
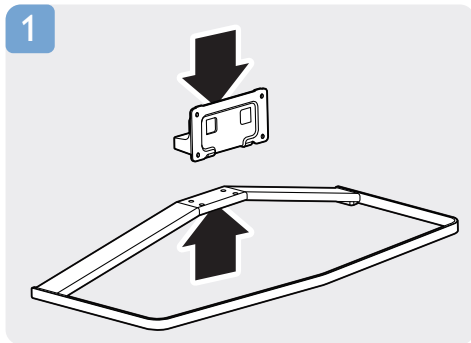
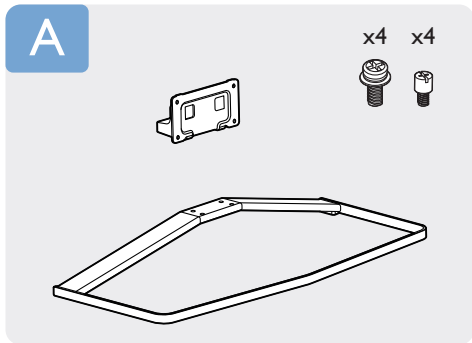

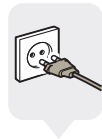
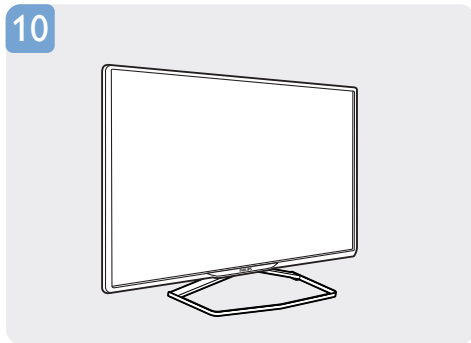
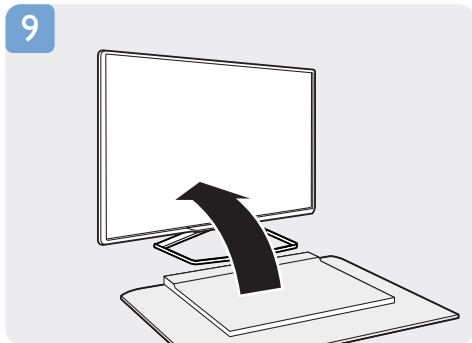
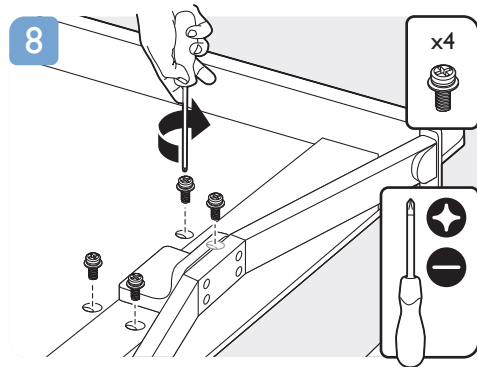
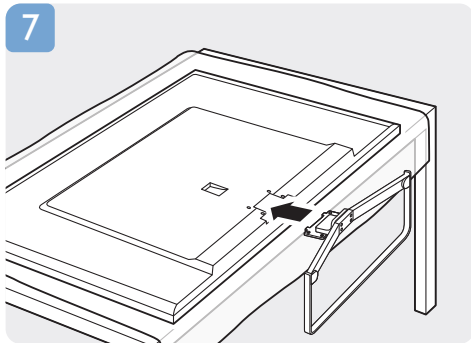
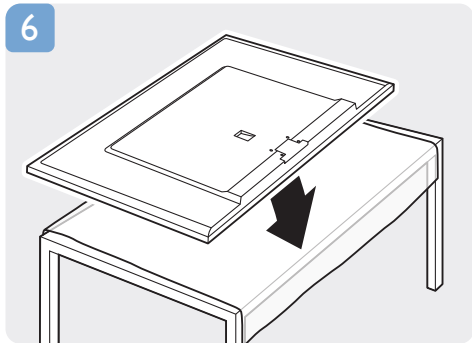

p.6

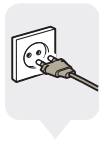
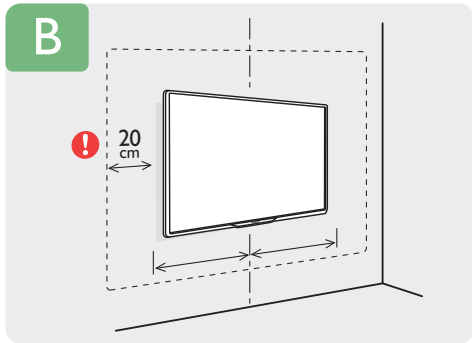

p.6

VESA (x,y)
400x400 M6

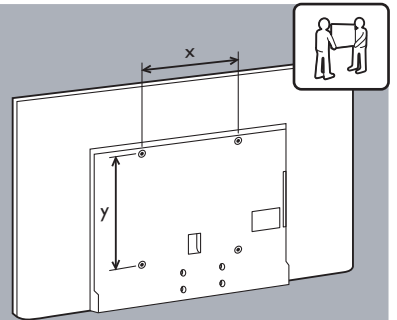

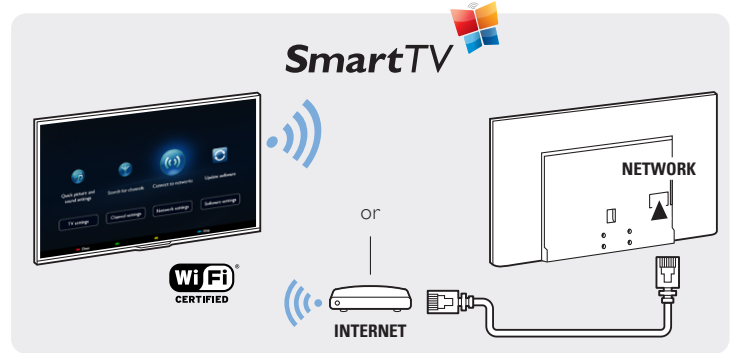
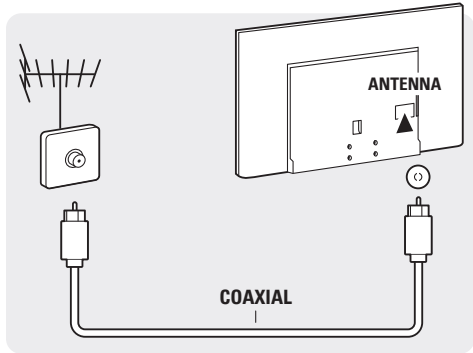
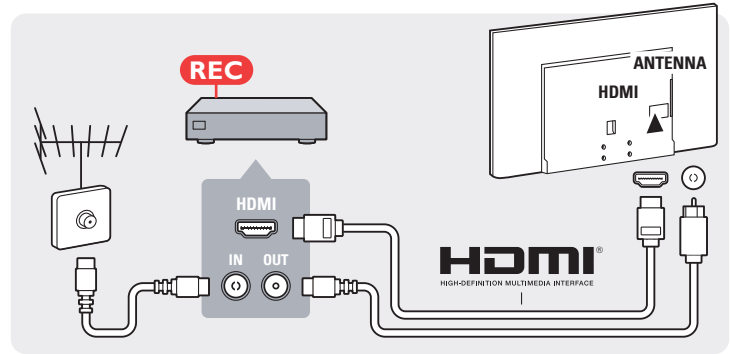
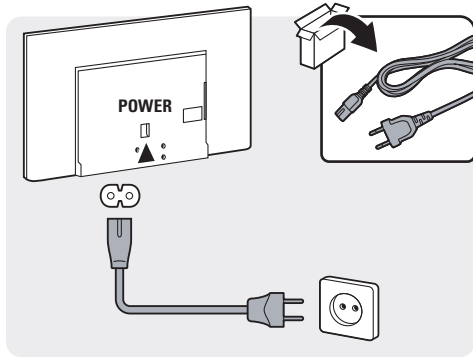
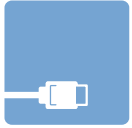

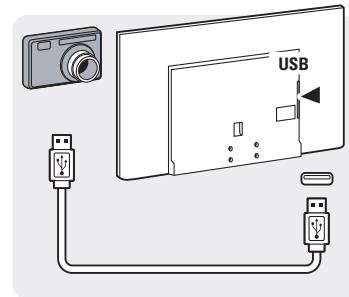
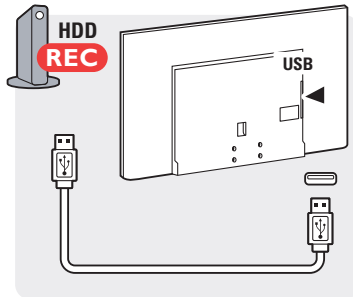
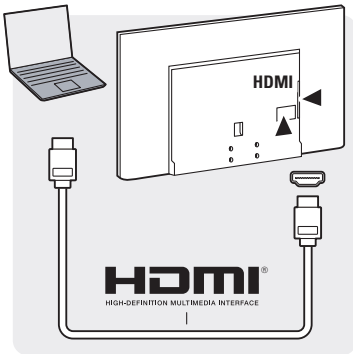
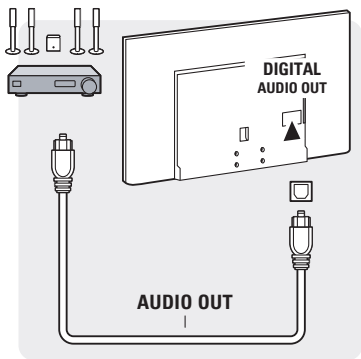
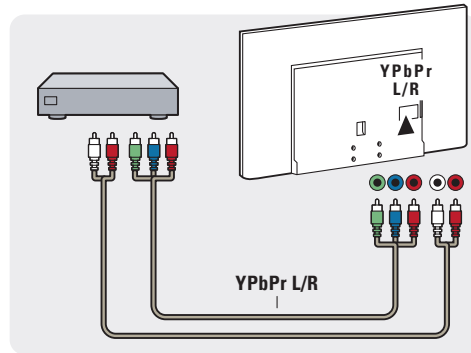
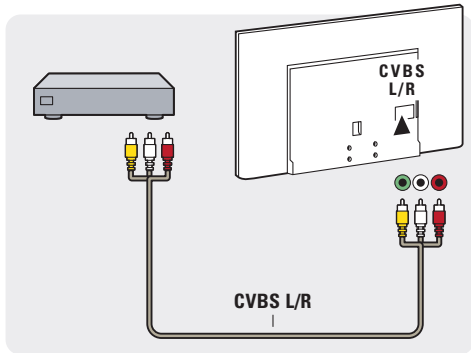
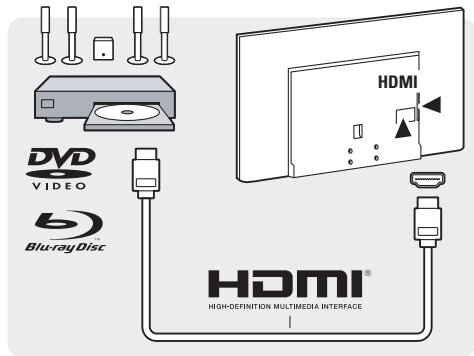

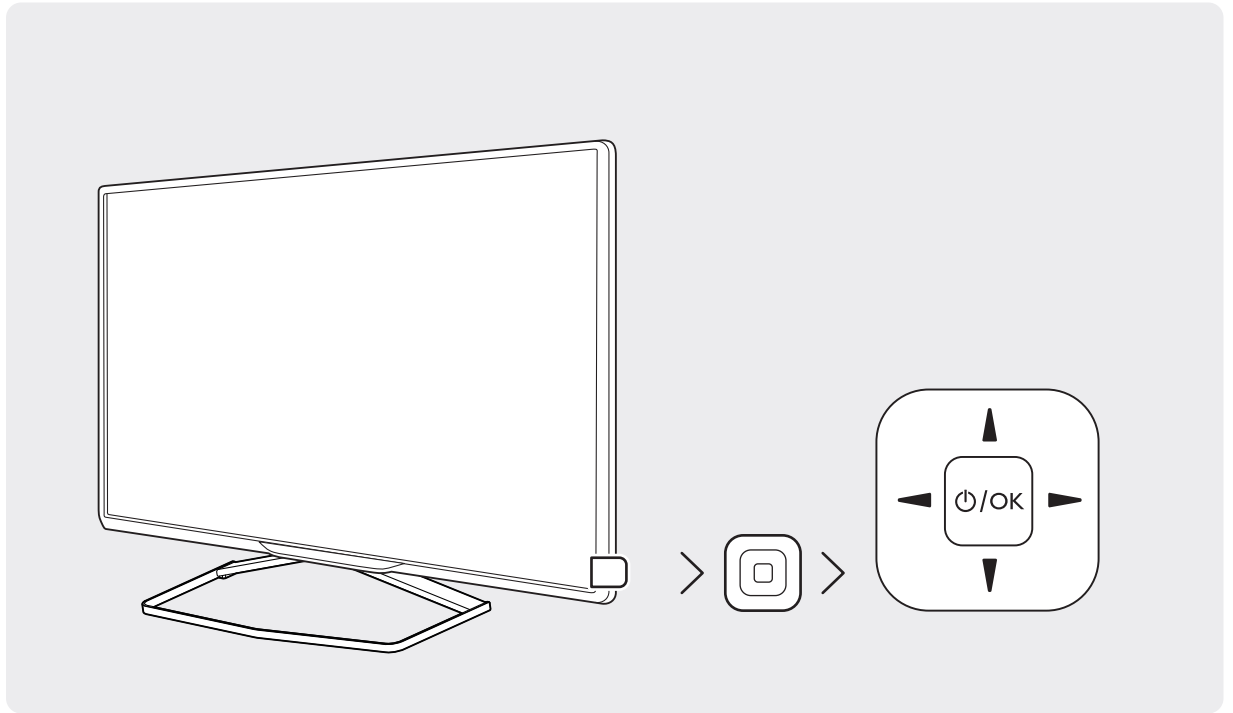

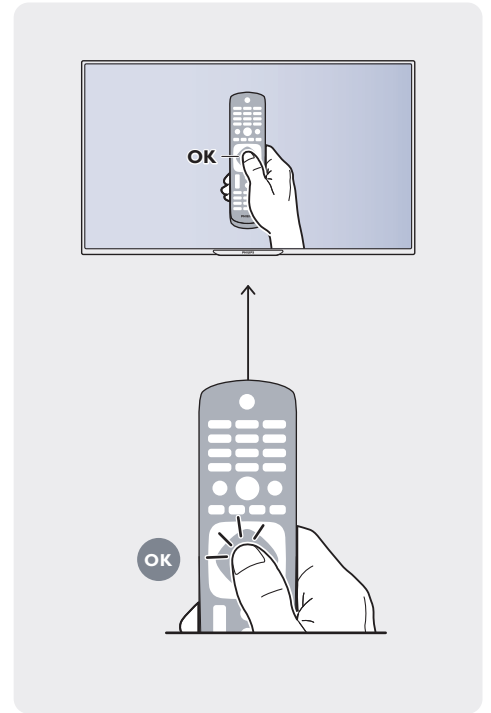
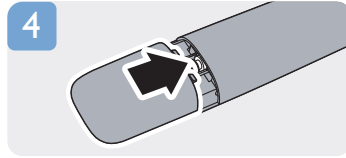
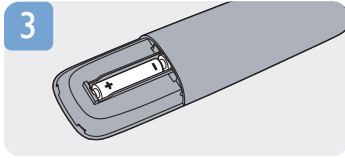
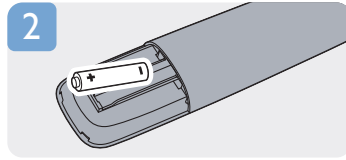
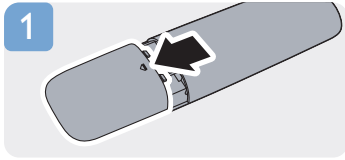





All registered and unregistered trademarks are the property of their respective owners.

Specifications are subject to change without notice.

Philips and the Philips' Shield Emblem are registered trademarks of Koninklijke Philips N.V. and are used under license from Koninklijke Philips N.V.

2014 © TP Vision Europe B.V. All rights reserved.

www.philips.com