

User Manual
Quick Start Guide Inside !

26TA2800
32TA2800

用户手册
内附快速使用指南!

دليل المستخدم
دليل المستخدم السريع بالداخل!



English

中文

العربية

Model No.: _____
Serial No.: _____

PHILIPS

How to make the optimal connection?

如何进行最佳连接？

จะสร้างการเชื่อมต่อที่ดีที่สุดได้อย่างไร?

كيف يمكن إنشاء أفضل اتصال؟

	<p>Best HDMI High-Definition Multimedia Interface provides an uncompressed, all-digital audio/video connection. HDMI provides the ultimated connection (Please use a certified HDMI cable.)</p>	<p>最好 HDMI 高清晰多媒体接口提供无压缩的全数字音频/视频连接。HDMI 提供的是终极的连接（请使用通过认证的 HDMI 线缆。）</p>	<p>ดีที่สุด HDMI High-Definition Multimedia Interface ให้การเชื่อมต่อที่เป็นเสียง/วิดีโอดิจิทัลทั้งหมด ซึ่งไม่มีการบีบขนาด HDMI เป็นการเชื่อมต่อที่มีคุณภาพระดับสุดยอด (โปรดใช้สายเคเบิล HDMI ที่ได้รับการรับรอง)</p>	<p>الأفضل HDMI توفر واجهة الوسائط المتعددة عالية الوضوح اتصال فيديو غير مضغوط يقبل كافة إشارات الفيديو/الصوت الرقمية. تتيح واجهة HDMI الاتصال النهائي (يرجى استخدام كابل HDMI المعتمد).</p>
	<p>Better Component Video input Provides superior picture quality by separating the green, blue and red luminance signals. Typically used with red/white audio cables.</p>	<p>很好 分量视频输入 通过将绿色、蓝色和红色亮度信号分离，提供卓越的画面质量。通常配合红色/白色音频线使用。</p>	<p>ดีกว่า อินพุตคอมโพเนนต์วิดีโอ ให้คุณภาพของภาพที่ยอดเยี่ยม โดยการแยกสัญญาณลูมิแนนซ์ของสีเขียว สีนํ้าเงิน และสีแดง โดยทั่วไปจะใช้กับสายเคเบิลเสียงสีแดง/ขาว</p>	<p>أحسن إدخال فيديو المكون يوفر جودة صورة فائقة عن طريق فصل إشارات الإضاءة الخضراء والحمراء والزرقاء. وعادة ما يُستخدم مع كابلات الصوت الحمراء/البيضاء.</p>
	<p>Good S-Video Supplies a better picture than RF and Composite connections. Used with red/white audio cables.</p>	<p>好 S 视频 提供比 RF 和复合连接更好的画面质量。配合红色/白色音频线使用。</p>	<p>ดี เอส-วิดีโอ ให้ภาพที่มีคุณภาพดีกว่าสัญญาณ RF และการเชื่อมต่อคอมโพสิต ใช้กับสายเคเบิลเสียงสีแดง/ขาว</p>	<p>⇒ S-Video يوفر هذا الاتصال صورة أفضل من اتصالات الترددات اللاسلكية والاتصالات المركبة. ويُستخدم مع كابلات الصوت الحمراء/البيضاء.</p>
	<p>Basic Composite Audio/Video Separate video (yellow) and audio (red/white) cables that provide a basic connection from the cable box and other devices. Note: The color of audio inputs may differ, e.g. red/ white or red/ black.</p>	<p>基本 复合音频/视频 分离视频（黄色）和音频（红色/白色）线，通过有线盒和其它设备提供基本连接。注意：音频输入的颜色可能不同，如红色/白色或红色/黑色。</p>	<p>พื้นฐาน คอมโพสิตออดิโอ/วิดีโอ แยกสายเคเบิลระหว่างวิดีโอ (สีเหลือง) และเสียง (สีแดง/ขาว) ซึ่งเป็นการเชื่อมต่อพื้นฐานจากเครื่องรับสัญญาณเคเบิล และอุปกรณ์อื่นๆ หมายเหตุ: สีของอินพุตเสียงอาจแตกต่างจากนี้ เช่น สีแดง/ขาว หรือสีแดง/ดำ</p>	<p>ساسي فيديو/صوت مركب كابلات فيديو (الأصفر) والصوت (الأحمر/الأبيض) منفصلة توفر اتصالاً أساسيًا من صندوق الكابلات والأجهزة الأخرى. ملاحظة: ربما يختلف لون إداخلات الصوت، على سبيل المثال الأحمر/الأبيض أو الأحمر/الأسود.</p>
	<p>RF Provides a basic connection for antenna or cable. Provides both audio and video.</p>	<p>RF 为天线或有线提供基本连接。提供音频和视频。</p>	<p>RF ให้การเชื่อมต่อพื้นฐานสำหรับเสาอากาศหรือเคเบิลทีวี ให้ทั้งสัญญาณเสียงและวิดีโอ</p>	<p>التردد اللاسلكي يوفر اتصالاً للهوائي أو الكابل. يوفر إشارات الصوت والفيديو.</p>

26TA2800

32TA2800

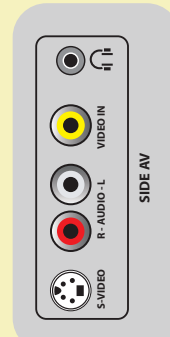
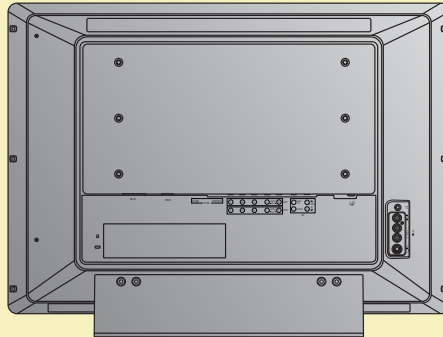
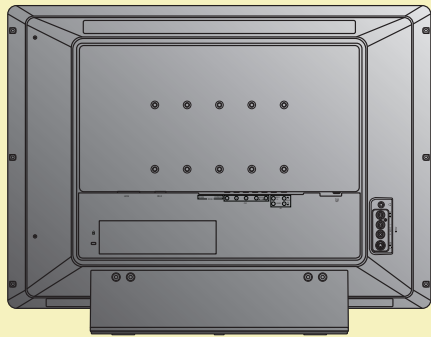

26TA2800



AC IN
DVI-D
PC IN - D-SUB, Audio input
CVI - Component (YPbPr), Audio L/R input
AV - Video input, S-video, Audio L/R input
75 Ω /RF
Side AV - S-video, Audio L/R, Video input
Earphone

AC IN
DVI-D
PC IN - D-SUB、音频输入
CVI - 分量 (YPbPr)、左/右音频输入
AV - 视频输入、S 视频、左/右音频输入
75 Ω /RF
Side AV - S 视频、左/右音频、视频输入
耳机

AC IN
DVI-D
PC IN - อินพุต D-SUB, เสียง
CVI - อินพุตคอมโพเนนต์ (YPbPr), อินพุตเสียง L/R
AV - อินพุตวิดีโอ, เอส-วิดีโอ, อินพุตเสียง L/R
75 Ω /RF
Side AV - เอส-วิดีโอ, อินพุตเสียง L/R, วิดีโอ
หูฟัง

AC IN
DVI-D
PC IN - D-SUB - PC IN, إدخال صوتي
CVI - مكون (YPbPr), إدخال صوت أيسر/أيمن
AV - إدخال فيديو, S-video, إدخال صوت أيسر/أيمن
75 أوم/ التردد اللاسلكي
S-video - Side AV, صوت أيسر/أيمن, إدخال فيديو, سماعات

32TA2800

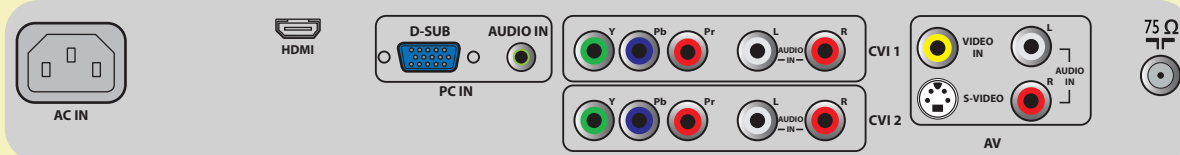

AC IN
HDMI
PC IN - D-SUB, Audio input
CVI 1 - Component (YPbPr), Audio L/R input
CVI 2 - Component (YPbPr), Audio L/R input
AV - Video input, S-video, Audio L/R input
75 Ω /RF
Side AV - S-video, Audio L/R, Video input
Earphone

AC IN
HDMI
PC IN - D-SUB、音频输入
CVI 1 - 分量 (YPbPr)、左/右音频输入
CVI 2 - 分量 (YPbPr)、左/右音频输入
AV - 视频输入、S 视频、左/右音频输入
75 Ω /RF
Side AV - S 视频、左/右音频、视频输入
耳机

AC IN
HDMI
PC IN - อินพุต D-SUB, เสียง
CVI 1- อินพุตคอมโพเนนต์ (YPbPr), อินพุตเสียง L/R
CVI 2- อินพุตคอมโพเนนต์ (YPbPr), อินพุตเสียง L/R
AV - อินพุตวิดีโอ, เอส-วิดีโอ, อินพุตเสียง L/R
75 Ω /RF
Side AV - เอส-วิดีโอ, อินพุตเสียง L/R, วิดีโอ
หูฟัง

AC IN
HDMI
PC IN - D-SUB - PC IN, إدخال صوتي
CVI 1 - مكون (YPbPr), إدخال صوت أيسر/أيمن
CVI 2 - مكون (YPbPr), إدخال صوت أيسر/أيمن
AV - إدخال فيديو, S-video, إدخال صوت أيسر/أيمن
75 أوم/ التردد اللاسلكي
S-video - Side AV, صوت أيسر/أيمن, إدخال فيديو, سماعات

1 Cable Box With RF In / Outputs Antenna TV

分线盒 (带有RF输入/输出)
天线电视

กล่องเคเบิลทีวีที่มีสัญญาณ RF
เข้า / เอาต์พุตเสาอากาศ TV

صندوق كابلات مزود بإدخال ترددات
لاسلكية/إخراج إشارات التلفاز بالهوائي

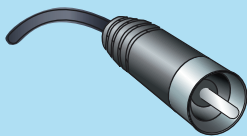

RF

Outdoor or Indoor Antenna (Combination VHF/UHF)
室内或室外天线 (VHF/UHF组合)



เสาอากาศนอกอาคาร หรือในอาคาร (การผสมระหว่าง VHF/UHF)
หوائي داخلی أو خارجي (مجموعة VHF/UHF)

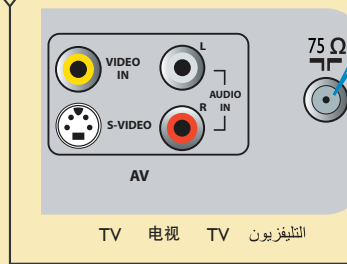
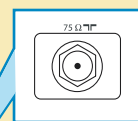

75 Ω
Twin-lead wire to 300-75 Ω adapter
接300-75 Ω 适配器的扁平双线索
สายคู่ไปยังอะแดปเตอร์ 300-75 Ω
سلك مزدوج إلى محول بمقاومة 75-300 أوم

or 或者 หรือ أو

Antenna with 75 Ω cable
天线 (75 Ω 电缆)
เสาอากาศที่มีขนาด 75 Ω
หوائي مزود بكابل بمقاومة 75 أوم

TV 电视 TV التلفزيون

or 或者 หรือ أو

The Cable TV signal from Cable Company

来自有线电视公司的有线电视信号

สัญญาณเคเบิลทีวีจากบริษัทเคเบิลทีวี

إشارة تلفزيون الكابل من شركة الكابل

A

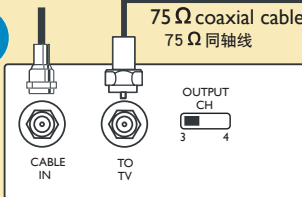

Cable Box 分线盒
กล่องเคเบิลทีวี صندوق كابلات

75 Ω coaxial cable 75 Ω 同轴线
สายโคแอกซ์ 75 Ω
كابل محوري بمقاومة 75 أوم

*After setting up, please run the Auto store function to set up the TV for the broadcast or cable channels available in your area. (please go to page 10 for detail)

*在设置之后，请进行自动搜寻功能在电视上设置您所在区域的广播或有线频道。(详细信息，请参见第10页。)

*หลังจากที่ตั้งค่า โปรดรับฟังก์ชัน ตั้งช่องอัตโนมัติ เพื่อตั้งช่องโทรทัศน์สำหรับสัญญาณที่เผยแพร่หรืออากาศ หรือของจากเคเบิลทีวีที่มีในพื้นที่ของคุณ (สำหรับรายละเอียด โปรดไปที่หน้า 10)

*بعد الإعداد، يرجى تشغيل وظيفة الحفظ التلقائي لإعداد القناة للبث أو لاستقبال قنوات الكابل المتوفرة في المنطقة التي تقطن بها. (يرجى الانتقال إلى الصفحة 10 للحصول على التفاصيل)

B

2 Cable Box With Audio / Video Outputs

分线盒 (带有声音/视频输出)

กล่องเคเบิลทีวีที่มีเอาต์พุตเสียง/วิดีโอ

صندوق كابلات مزود بإخراجات صوت/فيديو

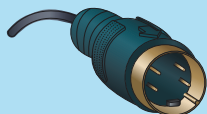

S-Video



Composite Audio/Video Input

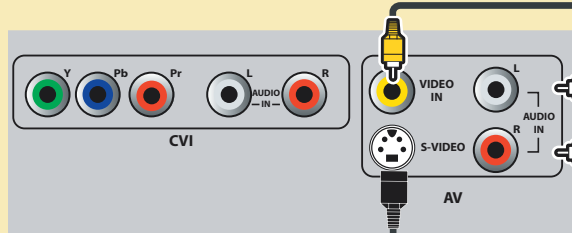

TV 电视 TV التلفزيون

B

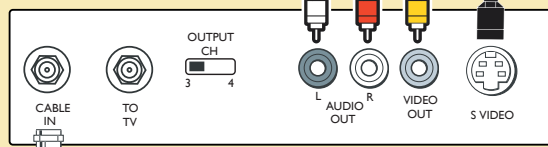

Cable Box 分线盒 กล่องเคเบิลทีวี صندوق كابلات

A

Cable TV Signal 有线电视信号 สัญญาณเคเบิลทีวี إشارة كابل التلفاز



AV Button
AV按钮
ปุ่ม AV
زر AV

*Use the AV button on the remote control to tune to the AV channel for the cable box signal. Once tuned, change channels at the cable box, not the television.

*使用遥控器上的AV按钮调到分线盒信号的AV频道。调整后，在分线盒(而不是电视)上更换频道。

*ใช้ปุ่ม AV บนรีโมทคอนโทรลเพื่อปรับช่อง AV สำหรับสัญญาณจากกล่องเคเบิลทีวี หลังจากปรับสัญญาณได้แล้ว ให้เปลี่ยนช่องที่กล่องเคเบิลทีวี ไม่ใช่ที่โทรทัศน์

* استخدم زر AV بوحدة التحكم عن بعد لموافقة قناة AV لإنشاء صندوق الكابل. بعد الموافقة، غير القنوات في صندوق الكابلات، وليس التلفزيون.

3

VCR, DVD Player, Or Other Devices With RCA Connectors

VCR, DVD播放机或带有 RCA 连接器的其它设备

VCR, เครื่องเล่น DVD หรืออุปกรณ์อื่นที่มี ขั้วต่อ RCA DVD مشغل أقراص، مشغل تسجيل الفيديو، أو أجهزة أخرى مزودة بموصلات RCA



S-Video

Composite Audio/Video Input

C



AV Button
AV按钮
ปุ่ม AV
زر AV

*Use AV button on the remote control to select AV1 or AV2 (side) if you use the different jacks for the hookup to watch VCR.

*使用遥控器上的AV按钮选择AV1(如果此连接方式使用不同的插孔)，还可选择AV2(Side)以观看VCR内容。

*ใช้ปุ่ม AV บนรีโมทคอนโทรลเพื่อเลือก AV1 หรือ AV2 (side) ถ้าคุณใช้แจ๊คที่แตกต่างกันสำหรับเสียบเพื่อดู VCR

* استخدام زر AV بوحدة التحكم عن بعد لتحديد AV2 (side) أو AV1 في حالة استخدام مقابس مختلفة للتطبيق لمشاهدة جهاز تسجيل الفيديو.

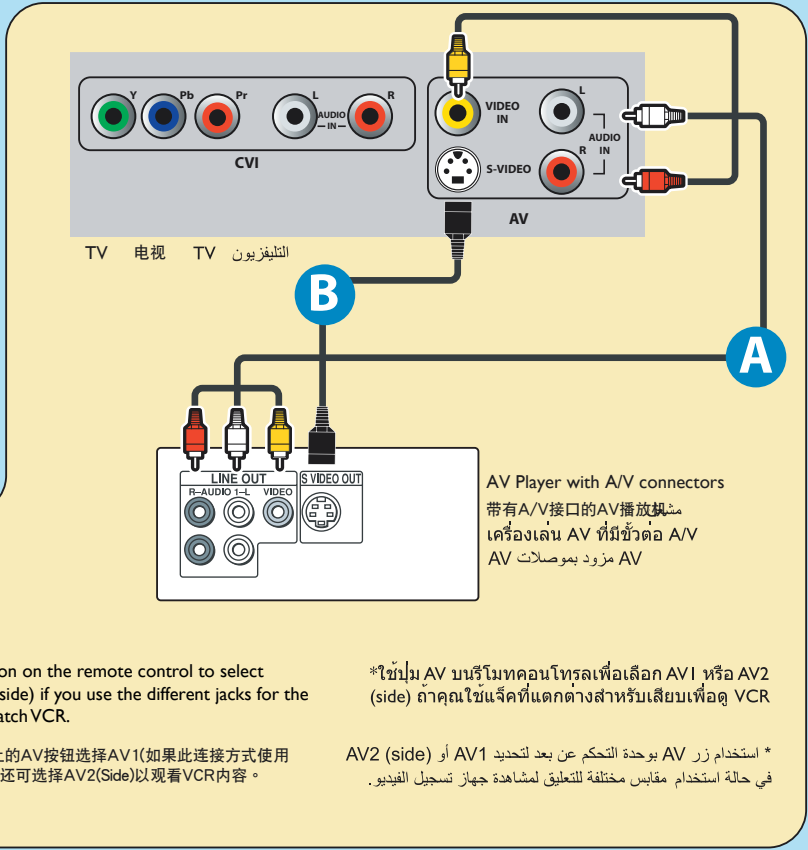

AV Player with A/V connectors
帶有A/V接口的AV播放機
เครื่องเล่น AV ที่มีขั้วต่อ A/V
AV مزود بموصلات AV

4

DVD Player Or Other Video Devices With Component Video Connectors

DVD播放机或其它带有 Component 视频连接器的视频设备

เครื่องเล่น DVD หรืออุปกรณ์วิดีโออื่นที่มี ขั้วต่อคอมโพเนนต์วิดีโอ

DVD مشغل أو جهاز فيديو آخر مزود بموصلات مكون فيديو

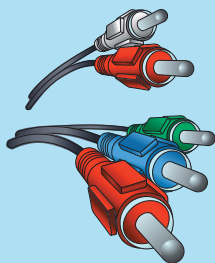

Component Video Input

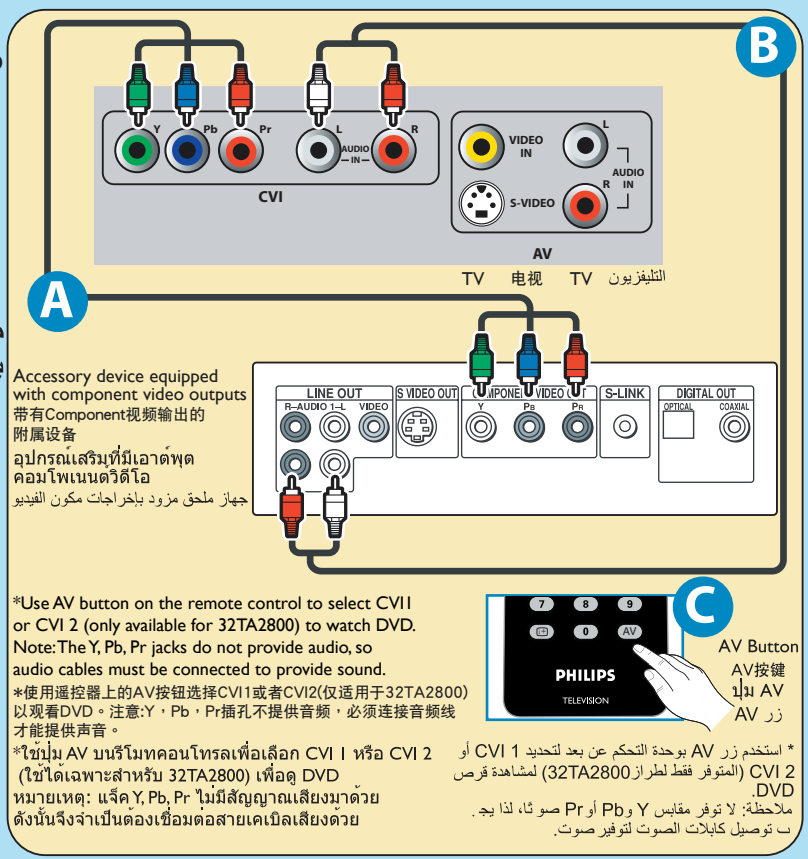

Accessory device equipped with component video outputs
帶有Component视频输出的附属设备
อุปกรณ์เสริมที่มีเอาต์พุตคอมโพเนนต์วิดีโอ
جهاز ملحق مزود باخراجات مكون الفيديو

*Use AV button on the remote control to select CVI1 or CVI 2 (only available for 32TA2800) to watch DVD. Note: The Y, Pb, Pr jacks do not provide audio, so audio cables must be connected to provide sound.

*使用遥控器上的AV按钮选择CVI1或者CVI2(仅适用于32TA2800)以观看DVD。注意:Y、Pb、Pr插孔不提供音频，必须连接音频线才能提供声音。

*ใช้ปุ่ม AV บนรีโมทคอนโทรลเพื่อเลือก CVI 1 หรือ CVI 2 (ใช้ได้เฉพาะสำหรับ 32TA2800) เพื่อดู DVD
หมายเหตุ: แจ็ค Y, Pb, Pr ไม่มีสัญญาณเสียงมาด้วย ดังนั้นจึงจำเป็นต้องเชื่อมต่อสายเคเบิลเสียงด้วย

* استخدم زر AV بوحدة التحكم عن بعد لتحديد CVI 1 أو CVI 2 (المتوفر فقط لطرز 32TA2800) لمشاهدة قرص DVD.
ملاحظة: لا توفر مقابس Y و Pb و Pr صوتا، لذا يجب بتوصيل كابلات الصوت لتوفير صوت.



AV Button
AV按钮
ปุ่ม AV
زر AV

5 PC (Monitor) Connections

PC (显示器)连接

การเชื่อมต่อกับพีซี (จอภาพ)

اتصالات الكمبيوتر (الشاشة)

C



AV Button
AV按钮
ปุ่ม AV
زر AV

*Use AV button on the remote control to select PC to use your LCD TV as a PC monitor.

*使用遥控器上的AV按钮选择PC，以将液晶电视用作PC显示器。

*ใช้ปุ่ม AV บนรีโมทคอนโทรลเพื่อเลือก PC เพื่อใช้ LCD TV ของคุณเพื่อจอภาพสำหรับพีซี

* استخدم زر AV بوحدة التحكم عن بعد لتحديد الكمبيوتر لاستخدام تلفزيون LCD على أنه شاشة كمبيوتر.

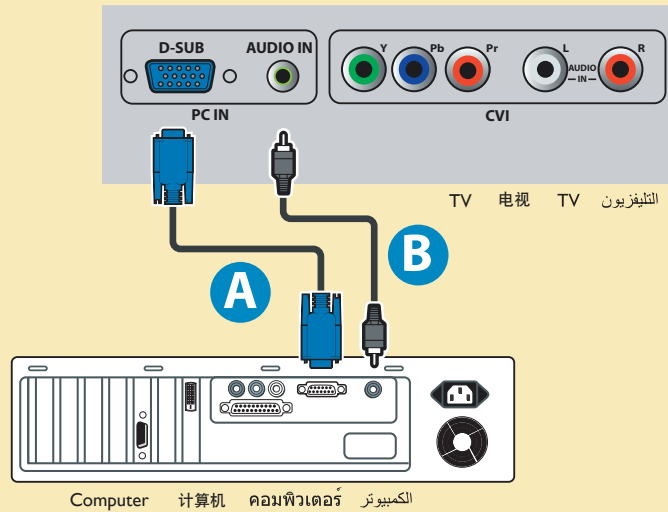

Computer 计算机 คอมพิวเตอร์ الكمبيوتر

TV 电视 TV التلفزيون

6 DVD Player With HDMI Connector

带有HDMI 连接器的DVD播放机

เครื่องเล่น DVD

ที่มีขั้วต่อ HDMI

مشغل DVD مزود بموصل HDMI



B



AV Button
AV按钮
ปุ่ม AV
زر AV

*Use AV button on the remote control to select HDMI to watch DVD.

*使用遥控器上的AV按钮选HDMI 以观看DVD。

*ใช้ปุ่ม AV บนรีโมทคอนโทรลเพื่อเลือก HDMI เพื่อดู DVD

* استخدم زر AV بوحدة التحكم عن بعد لتحديد HDMI لمشاهدة DVD.

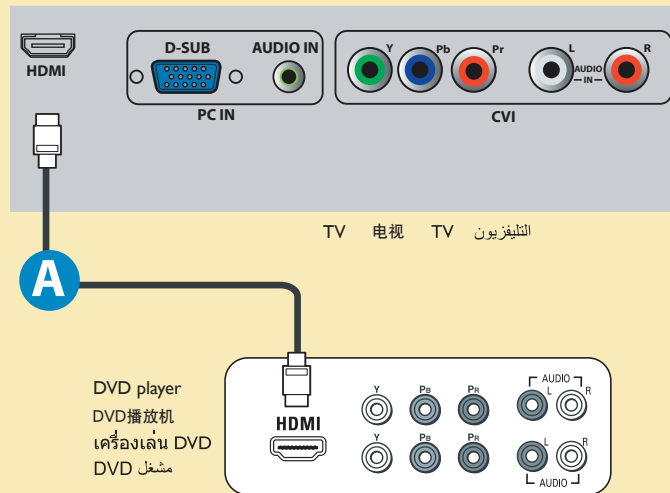

DVD player
DVD播放机
เครื่องเล่น DVD
مشغل

TV 电视 TV التلفزيون

PHILIPS

*Congratulations on your purchase,
and welcome to the “family!”*

Dear PHILIPS product owner:

Thank you for your confidence in PHILIPS. You’ve selected one of the best-built, best-backed products available today. We’ll do everything in our power to keep you happy with your purchase for many years to come.

Know these

safety symbols



 This “bolt of lightning” indicates uninsulated material within your unit may cause an electrical shock. For the safety of everyone in your household, please do not remove product covering.

 The “exclamation point” calls attention to features for which you should read the enclosed literature closely to prevent operating and maintenance problems.

WARNING: To reduce the risk of fire or electric shock, this apparatus should not be exposed to rain or moisture and objects filled with liquids, such as vases, should not be placed on this apparatus.

CAUTION: To prevent electric shock, match wide blade of plug to wide slot, fully insert.

For Customer Use

Enter below the Serial No. which is located on the rear of the cabinet. Retain this information for future reference.

Model No. _____
Serial No. _____

IMPORTANT SAFETY INSTRUCTIONS

Read before operating equipment

1. Read these instructions.
2. Keep these instructions.
3. Heed all warnings.
4. Follow all instructions.
5. Do not use this apparatus near water.
6. Clean only with a dry cloth.
7. Do not block any of the ventilation openings.
Install in accordance with the manufacturers instructions.
8. Do not install near any heat sources such as radiators, heat registers, stoves, or other apparatus (including amplifiers) that produce heat.
9. Do not defeat the safety purpose of the polarized or grounding-type plug. A polarized plug has two blades with one wider than the other. A grounding type plug has two blades and third grounding prong. The wide blade or third prong are provided for your safety. When the provided plug does not fit into your outlet, consult an electrician for replacement of the obsolete outlet.
10. Protect the power cord from being walked on or pinched particularly at plugs, convenience receptacles, and the point where they exit from the apparatus.
11. Only use attachments/accessories specified by the manufacturer.
12.  Use only with a cart, stand, tripod, bracket, or table specified by the manufacturer, or sold with the apparatus. When a cart is used, use caution when moving the cart/apparatus combination to avoid injury from tip-over.
13. Unplug this apparatus during lightning storms or when unused for long periods of time.
14. Refer all servicing to qualified service personnel. Servicing is required when the apparatus has been damaged in any way, such as power-supply cord or plug is damaged, liquid has been spilled or objects have fallen into apparatus, the apparatus has been exposed to rain or moisture, does not operate normally, or has been dropped.
15. **Damage Requiring Service** - The appliance should be serviced by qualified service personnel when:
 - A. The power supply cord or the plug has been damaged;
 - B. Objects have fallen, or liquid has been spilled into the appliance;
 - C. The appliance has been exposed to rain
 - D. The appliance does not appear to operate normally or exhibits a marked change in performance;
 - E. The appliance has been dropped, or the enclosure damaged.
16. **Tilt/Stability** - All televisions must comply with recommended international global safety standards for tilt and stability properties of its cabinet design.
 - Do not compromise these design standards by applying excessive pull force to the front, or top, of the cabinet which could ultimately overturn the product.
 - Also, do not endanger yourself, or children, by placing electronic equipment/toys on the top of the cabinet. Such items could unsuspectingly fall from the top of the set and cause product damage and/or personal injury.
17. **Wall or Ceiling Mounting** - The appliance should be mounted to a wall or ceiling only as recommended by the manufacturer.
18. **Power Lines** - An outdoor antenna should be located away from power lines.
19. **Outdoor Antenna Grounding** - If an outside antenna is connected to the receiver, be sure the antenna system is grounded so as to provide some protection against voltage surges and built up static charges.
20. **Object and Liquid Entry** - Care should be taken so that objects do not fall and liquids are not spilled into the enclosure through openings.
21. **Battery Usage CAUTION** - To prevent battery leakage that may result in bodily injury, property damage, or damage to the unit:
 - Install all batteries correctly, with + and - aligned as marked on the unit.
 - Do not mix batteries (old and new or carbon and alkaline, etc.).
 - Remove batteries when the unit is not used for a long time.
22. For ventilation, leave at least 4" to 6" free all around the TV. Do not place the TV on a carpet.
23. The equipment shall not be exposed to dripping or splashing.
24. The equipment shall not be exposed to rain or moisture and objects filled with liquids, such as vases, shall be placed on the apparatus.
25. The apparatus must be connected to a mains socket outlet with a protected earthed connection.
26. The appliance coupler is used as the disconnect device of this apparatus, the disconnect device shall remain readily operable.

Precaution

ADDITIONAL SAFETY PRECAUTIONS

- ENSURE that LCD TV stand is tightened properly to the set on the right way of tightening of the screw of the stand to the set. Improper tightening of screw may render the set unsafe.
- If LCD TV is installed on the wall, installation should be carried out by qualified servicemen. Improper or incorrect installation may render the set unsafe.
- Disconnect main plug when :
 - cleaning the TV screen, never use abrasive cleaning agents.
 - there is a lightning storm.
 - the set is left unattended for a prolonged period of time.
- Do not shift or move the LCD TV around when it is powered on.
- Do not touch, push or rub the surface of the LCD screen with any sharp or hard objects.
- When the surface of the LCD screen becomes dusty, wipe it gently with an absorbent cotton cloth or other soft material like chamois. DO NOT USE acetone, toluene or alcohol to clean the surface of the screen. These chemicals will cause damage to the surface.
- Wipe off water or saliva as soon as possible. These liquids can cause deformation and color fading of the LCD screen when left exposed for some time.
- Be careful of condensation when temperature changes occur. Condensation can cause damage to the LCD screen and electrically parts. After condensation fades, spots or blemishes will be present on the LCD screen.

POSITIONING THE LCD TELEVISION

- Place the LCD TV on a solid, sturdy base or stand. Be sure the stand is strong enough to handle the weight of the LCD TV.
- Try to leave at least 6” of space around each side of the LCD TV cabinet to allow for proper ventilation.
- Do not place the LCD TV near a radiator or other sources of heat.
- Do not place the LCD TV where it can be exposed to rain or excessive moisture.

RECYCLING PROCEDURE/END OF LIFE DISPOSAL

- To minimize harm to the environment, the batteries supplied with the LCD TV do not contain mercury or nickel cadmium. If possible, when disposing of batteries, use recycling means available in your area.
- The LCD TV uses materials that can be recycled. To minimize the amount of waste in the environment, check your area for companies that will recover used televisions for dismantling and collection of reusable materials, or contact your dealer for TV recycling tips.
- Please dispose of the carton and packing material through the proper waste disposal management in your area.

Contents

Here are a few of the special features of your new LCD TV.

Audio/Video In Jacks: Use to quickly connect other equipment to your LCD TV.

Automatic Channel Storing (Auto Store): Quick and easy setup of available channels.

On-screen Menus: Helpful messages (in English, Simplified Chinese, Thai, or Arabic) for setting TV controls.

Remote Control: Works your LCD TV features.

Sleep Timer: Turns off the LCD TV within an amount of time you specify (0-180 minutes from the current time).

AutoLock: Lets you block viewing of certain TV channels if you do not want your children viewing inappropriate material.

Standard broadcast (VHF/UHF) or Cable TV channel capability.

Stereo capability: Includes a built-in amplifier and twin-speaker system, allowing reception of TV programs broadcast in stereo.

Treble, Bass, and Balance: Enhance the LCD TV's sound.

Care of the screen See Tips, p. 25



End of life directives - Recycling

Philips has paid a lot of attention to producing an environmentally friendly product. Your new TV contains several materials that can be recycled for new uses. At the end of its life, specialized companies can dismantle and recycle this set. This will minimize the amount of materials being disposed of. Please be sure to dispose of this set in accordance with all state and local regulations.

Welcome	1
IMPORTANT SAFETY INSTRUCTIONS	2
Precaution	3
Contents	4
Preparation	5
Wall mounting	5
Use of the remote control	6
Buttons on the top of the TV	8
To use the menus	9
How to navigate through the Settings menu	9
Introduction	9
TV menu	10
Install	10
Select the menu language	10
Store TV channels	10
Manual sotre, Prog. no, Finetune, Store	11
Channel setting, Channel edit, Channel swap,	12
Name edit, Channel sort	12
Factory reset	13
Features menu	14
Picture menu	16
Sound menu	18
Record with your recorder.	19
Record a TV program	19
PC menu	20
Picture menu	20
Sound menu	22
Trouble shooting tips	23
Glossary.	24
Care and cleaning	25
Specification	26

- ❶ **Do not insert the power plug in a wall socket before all connections are made.**

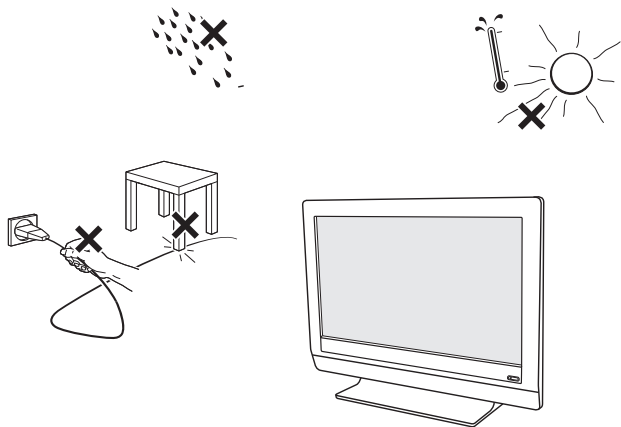

Place the TV on a solid surface.

For ventilation, leave at least 4" to 6" free all around the TV. Do not place the TV on a carpet. To prevent any unsafe situations, no naked flame sources, such as lighted candles, should be placed in the vicinity. Avoid heat, direct sunlight and exposure to rain or water. The equipment shall not be exposed to dripping or splashing.

Mounting the TV on the wall

This TV set complies with the VESA standard for wall mounting. Refer to specification page 26 for detail.

Caution: Installing the TV requires special skills that should only be performed by qualified personnel. You should not attempt to do the work yourself. Philips bears no responsibility for improper mounting or mounting that results in accident or injury.

Make sure that the wall mount is being fixed securely enough so that it meets safety standards.

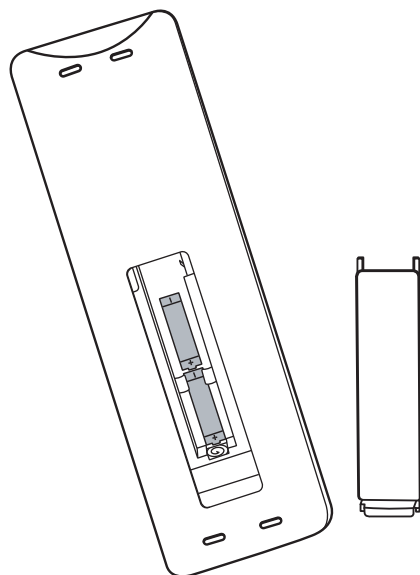

- ❷ **To connect accessory devices, see Cover and Connection.**
- ❸ **Refer to the bottom of the set (Model label) for the correct operation voltage.**

Insert the power cord into the wall socket.

Consult your local dealer if your main power supply voltage is different than that indicated for the TV. Never place the TV on top of the (AC) cord. Placing the TV on top of the AC cord could cause a fire or electric shock.

- ❹ **Remote control:**
Insert the two supplied AAA batteries.
The batteries supplied do not contain the heavy metals mercury and cadmium. Please determine and comply with local regulations when disposing of depleted batteries.
- ❺ **Turn the TV on:**
Press the power switch  at the front side of the TV. An indicator on the front of the TV lights up.
Press the **POWER** button or the **P + / -** button on the remote control.

Use of the remote control

*Note: Pressing most buttons once will activate the assigned function. Pressing a second time will de-activate it. When a button enables multiple options, a small list will be shown. Press repeatedly to select the next item in the list. The list will be removed automatically after six seconds or press **OK** to remove immediately.*

Sleep button

Press to set the LCD TV to turn itself off within a certain time.

Smart Sound button

Press repeatedly to select among the 5 settings: Personal, Speech, Music, Movie, or Multimedia.

Smart Picture button

Press repeatedly to select either Personal, Rich, Nature, Soft, or Multimedia of picture setting.

MENU

Press menu to activate on screen menu on/off.

VOL +/-

Press + or - to adjust the volume.

A/CH button

Press to go to previously selected channel.

Information button

Press to see the current channel number on the TV screen.

Teletext button

Teletext On/Off

Teletext hold

Freezes the teletext page.

Teletext mix

Teletext background become transparent, content mixes with images.

Teletext reveal/conceal

Press to toggle between conceal and reveal mode.

Main index

Press to return to the main index.

Teletext enlarge

Press to enlarge context to two times larger.



These four color buttons allow you to access the item or the page indicated by corresponding color in teletext.

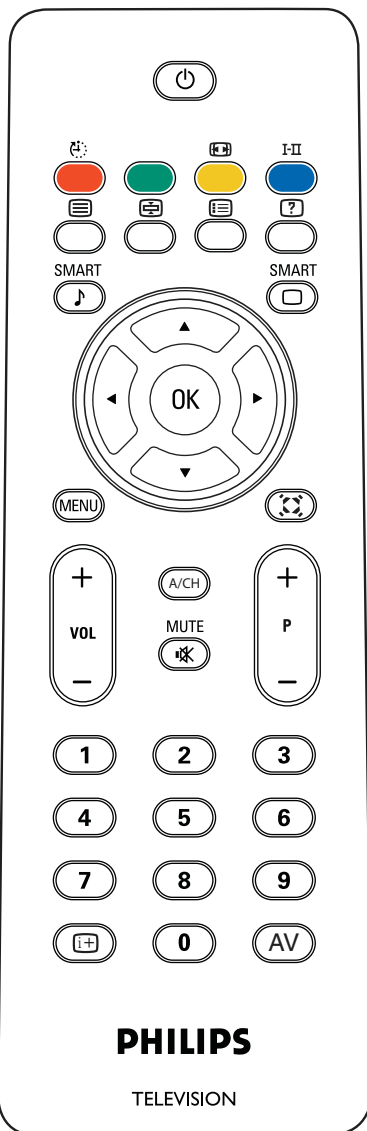

POWER

Press to turn the LCD TV on or off.

Picture Format button

Press the FORMAT button repeatedly to toggle among the six screen format sizes: Super zoom, 4:3, Movie expand 14:9, Movie expand 16:9, 16:9 Subtitle, or Widescreen.

I-II button / Sound mode

Press repeatedly to select Mono, Stereo, Dual I, Dual II, Nicam Mono, Nicam Stereo, Nicam Dual I, Nicam Dual II.

Note: The sound mode selections depend on TV program and broadcast TV channel of that region.

Virtual Surround button

Adds greater depth and dimension to TV sound.

Select from Virtual Surround ON or Virtual Surround OFF.

Mute button

Press to eliminate or restore the LCD TV sound. Mute will appear on the screen when the sound is muted.

P +/-

Press to adjust the channel up or down. Press to roll the teletext page up or down.

Number button

Press the number buttons for direct access to the TV channels. For 2 digit channel, enter the 2nd digit after enter 1st digit.

AV button

Press to select the video input source: 26TA2800:

TV, CVI, AVI, AV2(side), PC, and DVI.

32TA2800

TV, CVI 1, CVI 2, AVI, AV2(side), PC, and HDMI.

Note: Teletext is only available in some of the Asia Pacific TV systems.

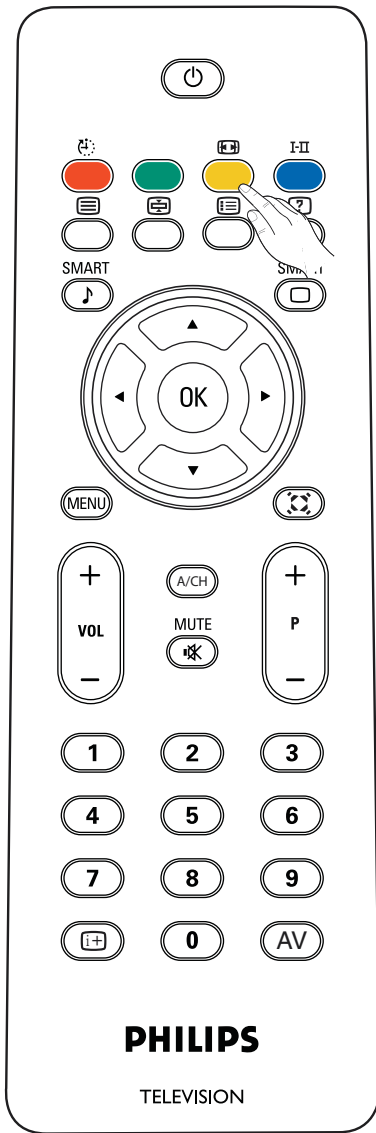

FORMAT

Press this button to display a list of available display formats. Available display formats are determined by the type of signal you are receiving.

To choose the display format you prefer, press the FORMAT button repeatedly:

For 26T2800/32TA2800

Super Zoom, 4:3, Movie expand 14:9, Movie expand 16:9, 16:9 Subtitle and Widescreen.

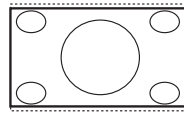

Super zoom

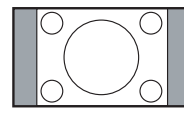

4:3

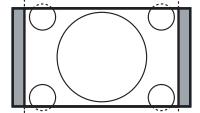

Movie expand 14:9

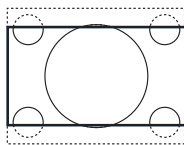

Movie expand 16:9

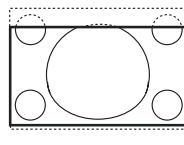

16:9 Subtitle

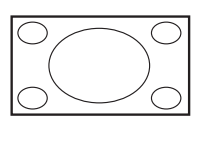

Widescreen

Super Zoom, Movie expand 14:9, Movie expand 16:9, and 16:9 subtitle make the picture fill the screen as much as possible. It is recommended to press the cursor up/down key to adjust the picture position on the screen.

Super zoom removes the black bars on the sides of 4:3 programs with minimal distortion. When in the Movie expand 14:9, Movie expand 16:9 or Super zoom picture format, you can make subtitles visible with the cursor up/down.

Note:

- For 720p/1080i/1080p, the default picture format will be Widescreen at CVI and DVI or HDMI modes. And the picture format function will not be accessible.
- For PC mode, the default picture format will be Full screen and picture format function can be accessible.

Buttons on the top of the TV

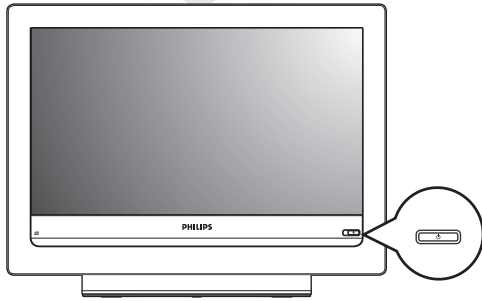

Should your remote be lost or broken you can still change some of the basic settings with the control buttons on your TV.

Press:

- the **⏻** button to switch the TV on or off.
- the **+ VOL** -button to adjust volume;
- the **+ CH** -buttons to select the TV channels or sources.

The **MENU** button can be used to display the Settings menu without the remote control. **MENU** button can also Exit the menu.

Use:

- the **+ VOL** - buttons and the **+ CH** - buttons to select menu items in the directions as shown;
- the **+ VOL** button to confirm your selection.

Introduction

When you use a menu or take an action, convenient instructions, help texts and messages will be displayed on your TV. Please, follow the displayed instructions and read the help text on the specific item highlighted.

The color buttons perform different actions, when using on screen menu. By pressing the corresponding color button on the remote control to perform the required action when using these menus.

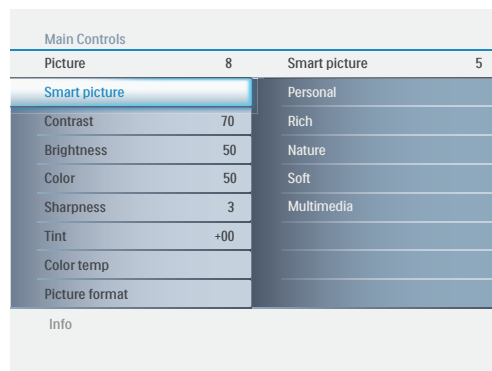
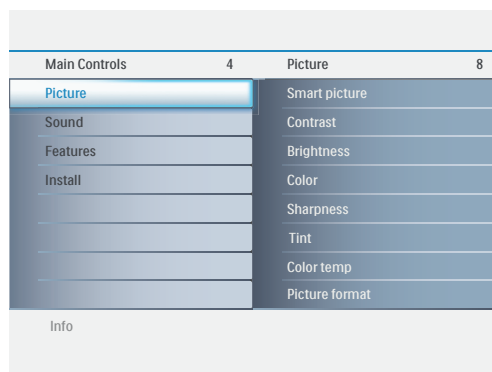

How to navigate through the Settings menus

The Settings menu allows you to access and change settings and preferences settings.

- Press the **MENU** button on the remote control to display the Settings menu.
- Use cursor up/down to highlight and select a menu item on the left panel.

The right panel shows the content of the menu you have highlighted in the left panel.

Note: Sometimes not all the menu items are visible on the screen. Use cursor down to scroll down to additional items.

- Use the cursor right to enter the right panel.

The content of the right panel is moved to the left panel and the right panel shows the content of the newly highlighted item in the left panel.

Note: In some cases, you will want to watch the picture on your screen while adjusting settings. This means that when the highlight is on the right side panel, the other menu items are hidden. When the cursor left is pressed again, the hidden menu items re-appear and the highlight moves to the left panel.

- Press the cursor left to go one menu level up again.
- Press the **OK** button on the highlighted item to activate and to dismiss the menu.
- Press the **MENU** button again to exit the Settings menu.

Note: The menu is also dismissed by pressing one of the color buttons (if present) referring to certain actions which may be executed.

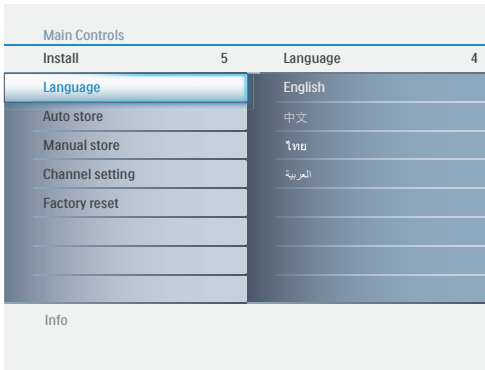

Select the menu language

- 1 Press the **MENU** button on the remote control.
- 2 Use the cursor down to select **Install** in the Settings menu.
- 3 Use the cursor right to enter the Install menu.
- 4 Select **Language** and enter the list of available languages with the cursor right.
- 5 Select your preferred language with the cursor up/down and press the **OK** button to confirm your selection.
- 6 Proceed with the Install menu.

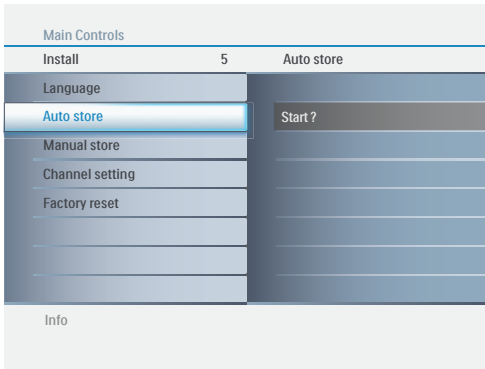

Store TV channels

- 1 Press the **MENU** button on the remote control.
- 2 Use the cursor down to select **Install** in the Settings menu.
- 3 Use the cursor right to enter the Install menu.
- 4 Press cursor down to select **Auto store** in the Install menu.
- 5 Use the cursor right to enter the **Auto store** menu and press **OK** to start scanning of channels.

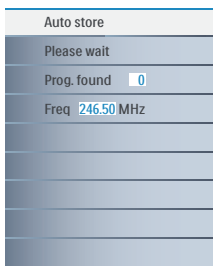

Auto storing may take up to 3 minutes to complete. Please wait until Auto storing is completed. The TV will then switch automatically to the first channel found.

Notes:

- Immediately after unpacking and plugging in your new television, run the auto store function to set up the TV for the broadcast or cable channels available in your area. If you do not run the auto store function to set up the channels, your television may not operate properly.
- After you've run Auto store, check out the results. Press P (+) or the P (-) button and see which channels you can select.
- Remember, an antenna or cable TV signal must first be connected to your LCD TV.

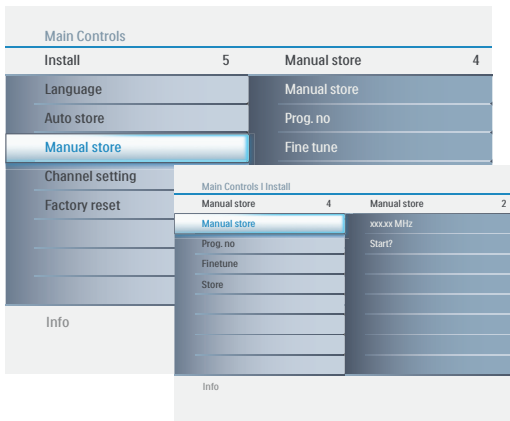

Manual store

- ❶ Select **Manual store** in the Install menu.
- ❷ Press the cursor right to enter **Manual store**, and press the cursor right again to activate auto search channel frequency or press number buttons to show your desired channel frequency.
- ❸ Use the cursor right to start searching.

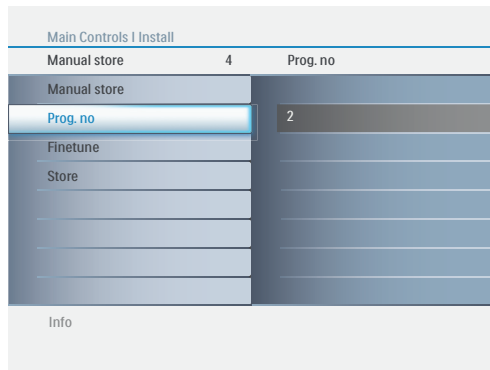

Prog. no

- ❶ Select **Prog. no** in the Manual store menu.
- ❷ Press the cursor right to enter it, when the channel frequency is confirmed.
- ❸ Press the cursor up/down to adjust the channel number.
- ❹ Press the cursor right/left to confirm the channel.

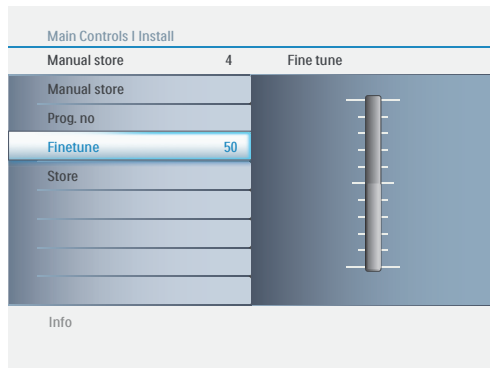

Finetune

- ❶ Select **Finetune** in the Manual store menu.
- ❷ Press the cursor right to enter **Finetune**.
- ❸ Press the cursor up/down to adjust.
- ❹ Press the cursor right/left to confirm.

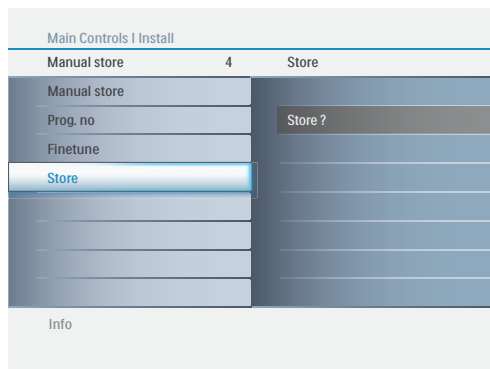

Store

- ❶ Select **Store** in the Manual store menu.
- ❷ Press the cursor right to enter **Store**.
- ❸ Press the cursor right to confirm stored.

Note:
If the channel reception is satisfactory, please go to page 12.

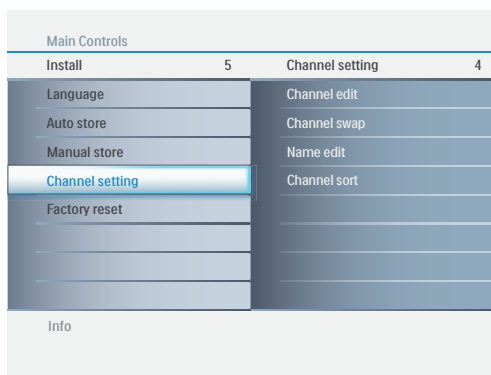

Channel setting

- 1 Select **Channel setting** in the Install menu.
- 2 Press the cursor right to enter **Channel setting**.
- 3 Use the cursor up/down to toggle among **Channel edit**, **Channel swap**, **Name edit**, or **Channel sort**.
- 4 Press the cursor right to enter the selection.

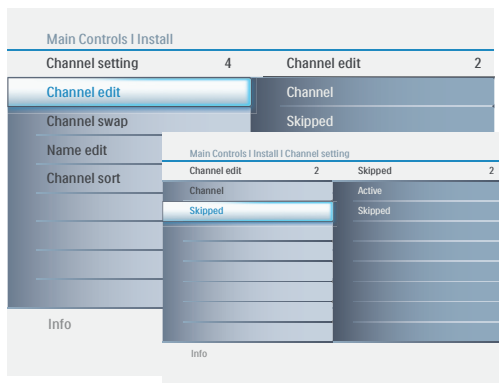

Channel edit

- 1 Select **Channel edit** in the Channel setting menu.
- 2 Press the cursor right to enter it.
- 3 Use the cursor up/down to select the channel that you want to add or remove.
- 4 Press the cursor right/left to confirm.
- 5 Select **Skipped** in the Channel edit menu.
- 6 Use the cursor up/down to select **Active** (to add) or **Skipped** (to remove) the channel you selected.
- 7 Press the cursor right/left to confirm.

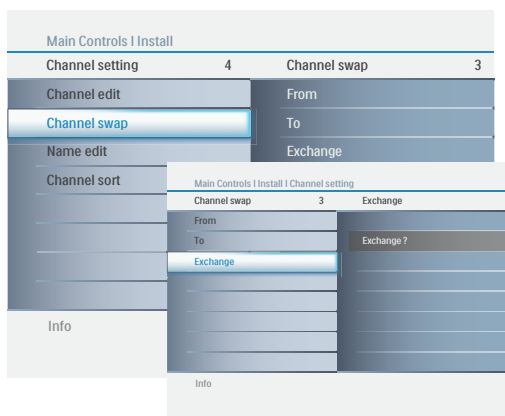

Channel swap

- 1 Select **Channel swap** in the Channel setting menu.
- 2 Press the cursor right to enter it.
- 3 Use the cursor up/down to select **From** or **To** and press the cursor right to enter the selection.
- 4 Use the cursor up/down to adjust the channel and press the cursor right/left to confirm.
- 5 Select **Exchange** in the Channel swap menu.
- 6 Press the cursor right to activate Exchange or press the cursor left to inactivate it.

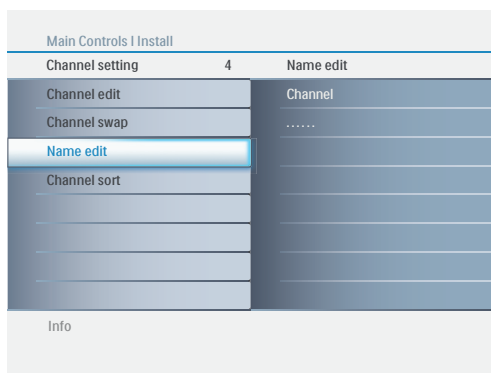

Name edit

- 1 Select **Name edit** in the Channel setting menu.
- 2 Press the cursor right to enter it.
- 3 Use the cursor up/down to edit name, and press the cursor right to move to the next character.
- 4 Press the cursor left to confirm the first character and press the cursor right to confirm the last character.
- 5 Press the cursor right to confirm the name.

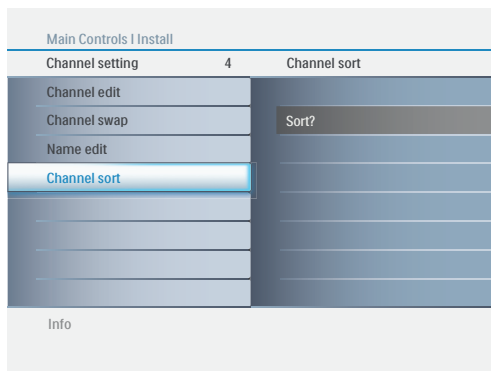

Channel sort

- 1 Select **Channel sort** in the Channel setting menu.
- 2 Use the cursor right to sort the channel.
- 3 Use the cursor left to return to the previous menu.

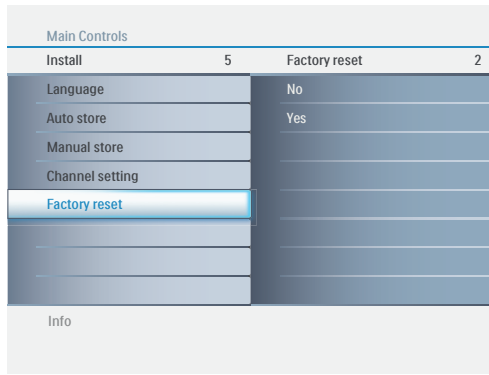

Factory reset

- 1 Select **Factory reset** in the Settings menu.
- 2 Press the cursor right to enter **Factory reset**.
- 3 Select **Yes** and press the cursor right for resetting the original factory settings.

Note:

If you reset the TV to the factory settings, all your present setting on picture, sound, and other feature settings will be erased and replaced by the manufacture's default settings. However, your AutoLock access code will not be erased. Please refer to page 15 for detail.

Features menu

- ❶ Select **Features** in the TV Settings menu.
- ❷ Press the cursor right to enter the features menu.
- ❸ Select the menu items with the cursor up/down, and adjust the settings with the cursor left/right.

Timer

- ❶ Select **Timer** in the Features menu.
- ❷ Use the cursor down to choose the item you want to adjust and press the cursor right to enter **Clock**, **Start time**, **Stop time**, and **Sleep timer**.

Clock: Allow you to set the time.

Start time: Allow you to set the time for turning on the TV automatically.

Stop time: Allow you to set the time for turning off the TV automatically.

Sleep timer: Allow you to set the time period, after which the TV will turn to standby mode automatically.
This list will have values from 0 to 180.

NR

Automatically filters out and reduces the image noise and improves picture quality when receiving weak video signals.

- ❶ Select **NR** in the Features menu.
- ❷ Press the cursor right to enter it.
- ❸ Use the cursor down to select **On** or **Off**.
- ❹ Press the cursor right to activate or inactivate noise reduction.

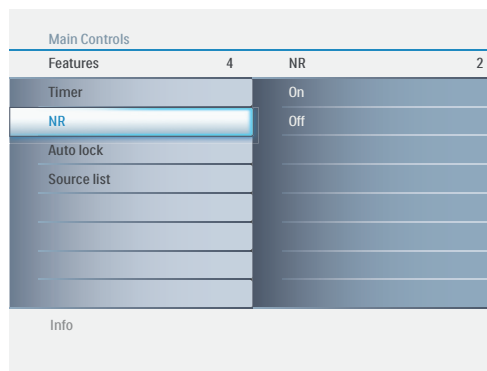
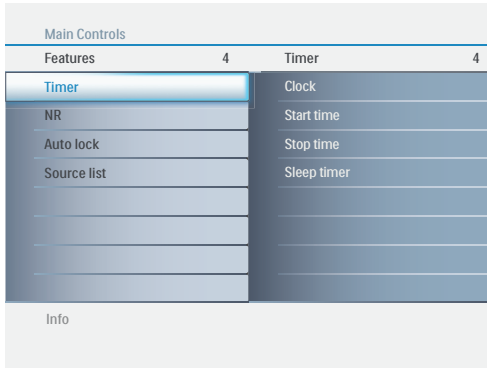
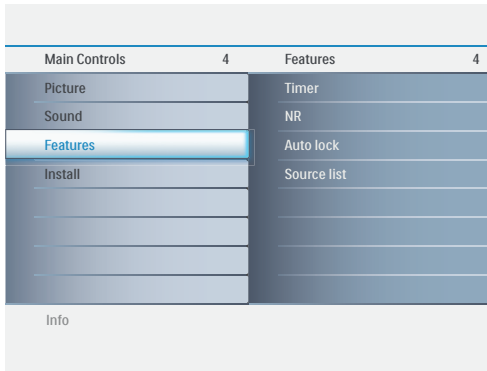

Auto lock

The **Auto lock** feature allows you to lock channels, and prevent your children from watching unsuitable content of programmes.

Auto lock offers various Blocking controls from which to choose:

Access code - An Access code must be set to prevent children from unblocking questionable or censored programming set by their parents.

Lock program - Select the TV channel you want to lock.

Change code - To change your access code or overwriting.

Clear all - To unlock all locked channels and programming.

- 1 Select **Auto lock** in the feature menu.
- 2 Press the cursor right to enter it.
- 3 Access code will appear on the screen.
- 4 Enter a four-digit code using the number buttons.

Note:

Remember that 0711 is the default Auto lock code. If your access code has been changed by someone other than you (a child, for example) or you have forgotten the code, you can always get in by inputting the default code.

Lock program

After your personal access code has been set, you are ready to select the channels or inputs you want to block out or censor.

- 1 Select **Lock program** in the Auto lock menu.
- 2 Press the cursor right to enter it.
- 3 Use the number buttons to enter the channel which you are going to block.
- 4 Press the cursor up/down to block the current channel.

Note:

You can block additional channels by using the number buttons to jump to another channel.

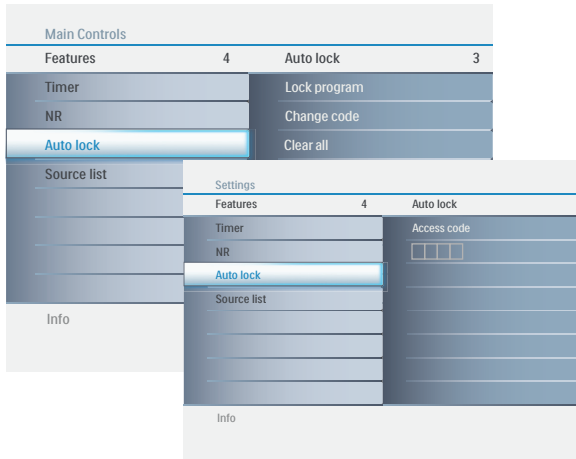
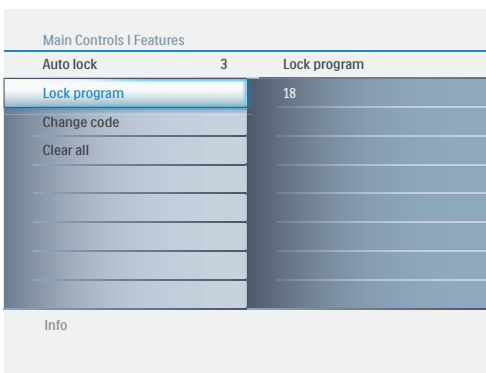

Picture menu

- ❶ Select **Picture** in the TV settings menu.
- ❷ Press the cursor right to enter the Picture menu.
- ❸ Select the menu items with the cursor up/down.
- ❹ Adjust the settings with the cursor left/right, and enter the list of submenu items with the cursor right. Select a submenu item with the cursor up or down.

Smart picture

- ❶ Select **Smart picture** to display a list of predefined picture settings, each corresponding with specific factory settings. **Personal** refers to the personal preference settings of picture in the picture menu.
Note: This Philips TV has been set at the factory to look best in bright store environments, which typically use fluorescent lighting. As your home will likely not be as well lit as a store, we recommend that you cycle through the various smart picture modes to find the one that best suits your own viewing conditions.
- ❷ You can press the **Smart picture** button on the remote control repeatedly to select either **Personal**, **Rich**, **Nature**, **Soft**, or **Multimedia** picture settings.

Note:

- The moment you are in a predefined Smart picture setting and you modify the Picture menu, all values of the menu will overwrite those previously made in personal setting.

Contrast

Adjust to “sharpen” the picture quality. The black portions of the picture become richer in darkness and the white become brighter.

Brightness

Adjust to brighten the dark parts of the picture. This appears to add white to the color.

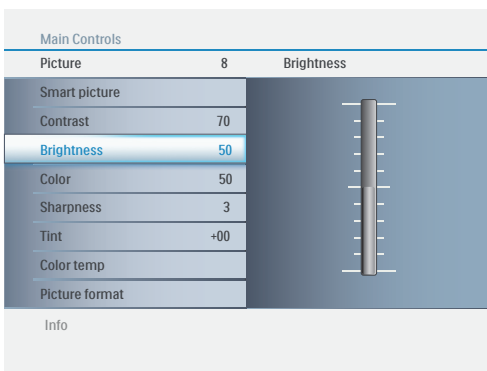
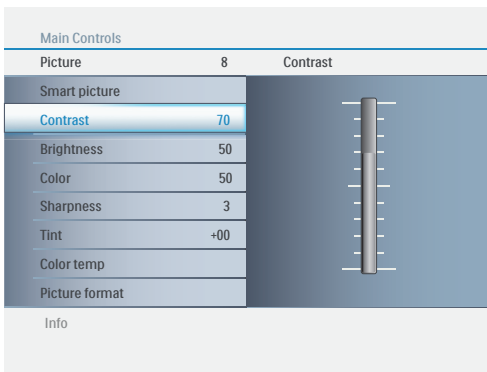
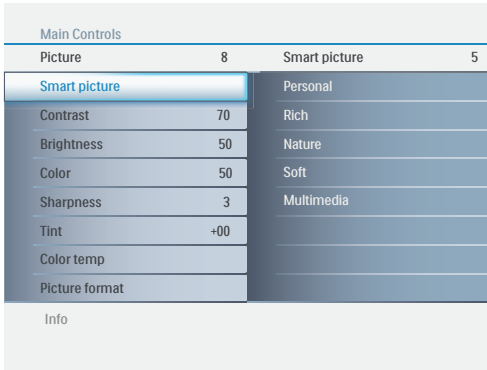
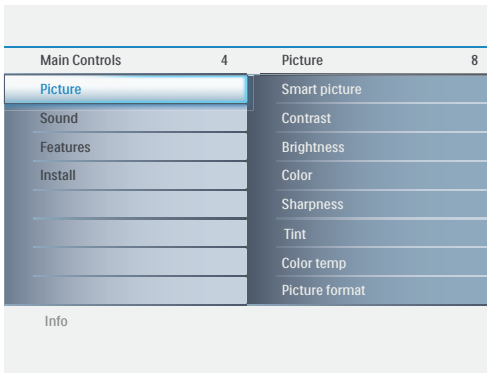

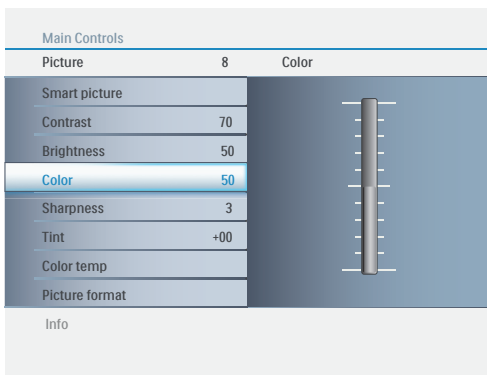

Color

Adjust to add or reduce color.

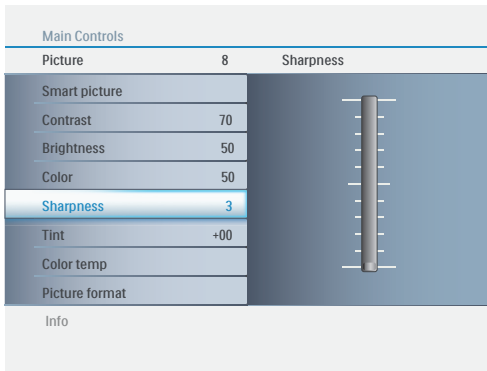

Sharpness

Adjust to improve detail.

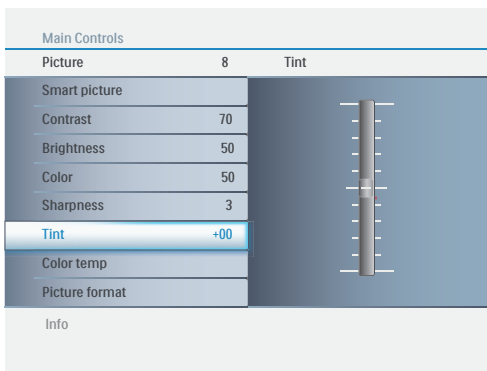

Tint

Allows you to select the picture's color mix or hue.

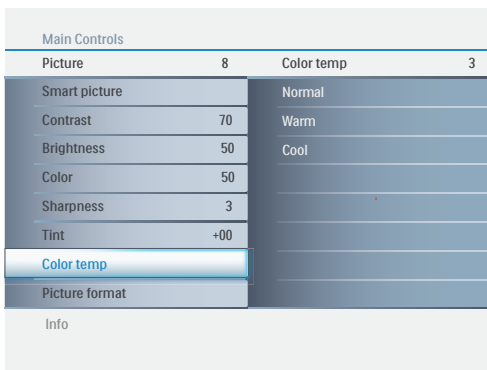

Color temp

Adjust to increase or decrease **Warm** (red) and **Cool** (blue) colors to suit personal preferences. Select **Cool** to give the white colors a blue tint, **Normal** to give the white colors a neutral tint, **Warm** to give the white colors a red tint.

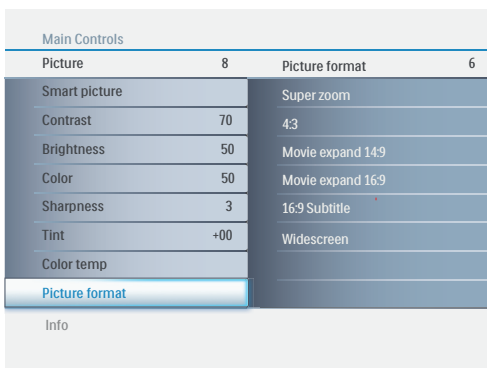

Picture format

Adjust to change the screen format to match the type of program you are watching. Please refer to page 7 for detail.

Note:
Any adjustment of Brightness, Color, Contrast or Sharpness will be stored into Personal at Smart picture section.

Record with your recorder

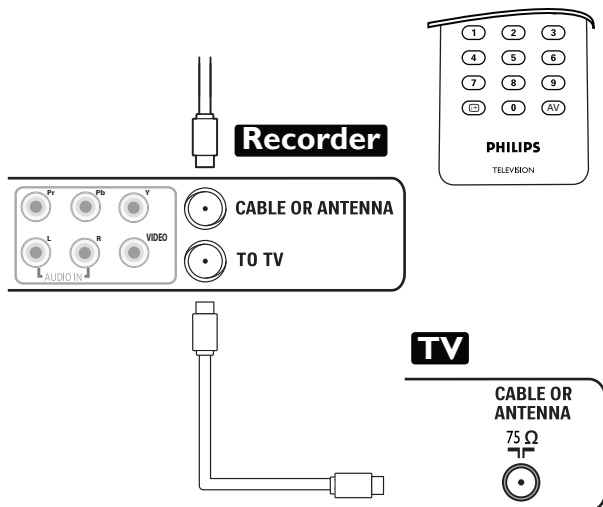

Record a TV program

You can record a TV program using your recorder's tuner without affecting your TV.

- 1 Select the channel number on your recorder.
- 2 Set your recorder to record.
See the handbook for your recorder.

Note: Switching channel numbers on your TV does not disturb recording !

To select connected devices

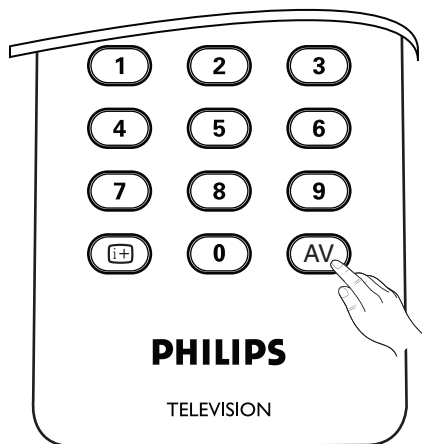

- 1 Press the **AV** button repeatedly or select Source list in the Settings menu to select **TV, CVI 1, CVI 2, AV 1, AV 2(side), PC, DVI or HDMI** according to where you connected your devices.

Note: DVI is only available for 26TA2800.

CVI 2 and HDMI are only available for 32TA2800.

- 2 Press the cursor up/down.
- 3 Press **OK**.

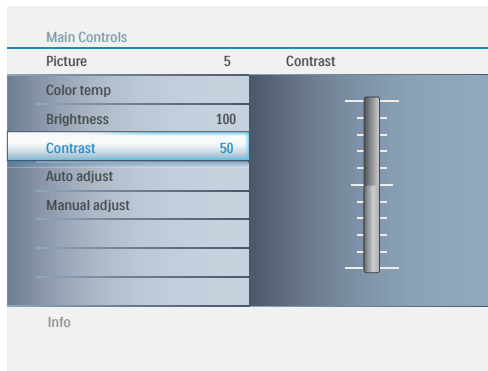
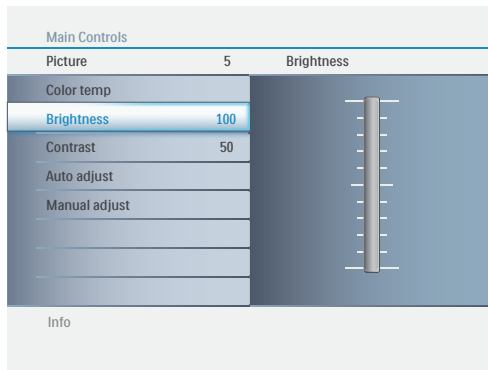
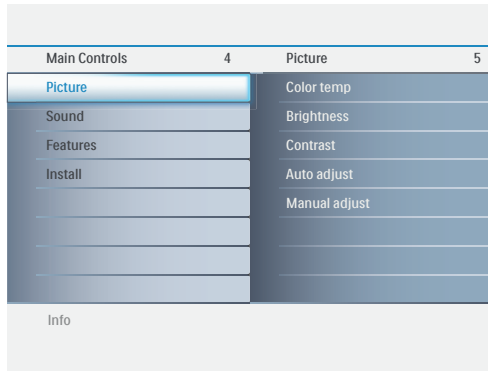

Note:

This TV can also be used as a PC Monitor. A PC video signal must be present or the TV will go into standby mode. The PC Picture controls allow you to adjust the picture. Please make sure you are in PC mode.

Picture

- ① Press the **MENU** button on the remote control.
- ② Select **Picture** in the Settings menu.
- ③ Use the cursor right to enter the Picture menu.
- ④ Use the cursor up/down to highlight the menu items.
- ⑤ Press the cursor right to enter the selection.
- ⑥ Use the cursor up/down to adjust the item.

Color temp

Adjust to increase or decrease **Warm** (red) and **Cool** (blue) colors to suit personal preferences.

Select **Cool** to give the white colors a blue tint, **Normal** to give the white colors a neutral tint, **Warm** to give the white colors a red tint.

Brightness

Adjust to brighten the darkest parts of the picture.

Contrast

Adjust to “sharpen” the Picture quality. The black portions of the picture become richer in darkness and the white become brighter.

Note:

Color temp can also be activated by pressing Smart picture button on your Remote Control.

Main Controls		
Picture	5	Auto adjust
Color temp		Yes
Brightness	100	
Contrast	50	
Auto adjust		
Manual adjust		
Info		

Auto adjust

The LCD Monitor will automatically adjust to the best image position, phase, and clock setting.

Main Controls		
Picture	5	Manual adjust 4
Color temp		Phase
Brightness	100	Clock
Contrast	50	Horizontal
Auto adjust		Vertical
Manual adjust		
Info		

Manual adjust

The Manual adjust control allows you to manually fine tune the image as it appears on the screen.

Phase - eliminates the horizontal interfering lines.

Clock - eliminates the vertical interfering lines.

Horizontal - adjust the horizontal placement of the picture.

Vertical - adjust the vertical placement of the picture.

- ① Use the cursor up/down to adjust the item.
- ② Press the cursor right to confirm.

Note:

If you are willing to reset adjustment back to original value, please enter to Factory Reset in Install menu.

Setting up the PC mode (Personal Computer Monitor)

26TA2800/32TA2800 (26"/32" LCD TV)

No	Resolution	Mode	V. Frequency (Hz)	H. Frequency (kHz)
1	640 x 480	VGA VESA 60	59.940	31.469
2	800 x 600	SVGA VESA 56	56.250	35.156
3		SVGA VESA 60	60.317	37.879
4	1024 x 768	XGA VESA 60	60.004	48.363
5	1280 x 720	VESA CVT	59.855	44.772
* 6	1360 x 768	VESA CVT	60.015	47.712

* Recommended Resolution

Trouble Shooting Tips

Symptoms	Items to Check and Actions to follow
“Ghost” or double images	<ul style="list-style-type: none"> This may be caused by obstruction to the antenna due to high rise buildings or hills. Using a highly directional antenna may improve the picture.
No power	<ul style="list-style-type: none"> Check that the TV’s AC power cord is plugged into the mains socket. Unplug the television, wait for 60 seconds. Then re-insert plug into the mains socket and turn on the television again.
No picture	<ul style="list-style-type: none"> Check antenna connections at the bottom of the TV to see if they are properly connected to the TV. Possible broadcast station trouble. Try another channel. Adjust the contrast and brightness settings. Try another auto picture setting. Check if you selected the correct AV source.
No picture and power switched on	<ul style="list-style-type: none"> Your TV has a protective mode in case there is too much heat build-up. Check the clearance around the vents of the device to be certain there are no blocking walls or cabinets which would limit the air flow.
Picture position adjustment	Most High Definition receiver boxes also have picture-positioning controls in their menu systems. If the TV cursor controls run out of range before the picture is correctly positioned, the receiver box controls will need to be adjusted.
No photo, music or video play or in poor quality only	<ul style="list-style-type: none"> Check if the source complies with a supported code.
No sound	<ul style="list-style-type: none"> Increase the VOLUME. Check that the TV is not muted, press the MUTE button on the remote control. When no signal is detected, the TV automatically switches off the sound. This is proper operation and does not indicate a malfunction.
Good sound but poor color or no picture	<ul style="list-style-type: none"> Adjust the contrast, color, tint and brightness setting. Try another auto picture setting.
Snowish picture and noise	<ul style="list-style-type: none"> Check the antenna connection.
Television not responding to remote control	<ul style="list-style-type: none"> Check whether the batteries are working. Replace if necessary. Clean the remote control sensor lens on the monitor. Operating range between TV and the remote control should not be more than approximately twenty feet. You can still use the buttons on the side of your TV. Check if the remote control is in the correct mode.
Control of accessory devices	<ul style="list-style-type: none"> The infrared signals of the screen may influence the reception sensibility of other peripherals Solution: replace the batteries of the remote control of other devices. E.g. keep away a wireless headphone from within a radius of approximately four feet.
The software will not install	<p>Possibly the operating system is wrong. Go to www.philips.com/usasupport to see which operating systems are supported.</p>
PC modes do not work	<ul style="list-style-type: none"> Check whether connections are correct. Check whether the source is correctly selected. Press AV button to select the correct source. Check whether you have configured the computer on a compatible display resolution.

Standby	Your TV consumes energy less than 2w in the standby mode.
After improper shutdown	If your TV has been shutdown in an improper way (e.g. power drop, power cord plug out), starting up the TV again will take a longer time than usual.
Miscellaneous	See Extras, Specifications on this user manual.

Glossary

Aspect Ratio	The ratio between the width and height of the TV picture on the screen. In a normal TV set the aspect ratio is 4 to 3 (4:3). The new aspect ratio in HDTV is 16:9 which resembles the aspect ratio in a movie theatre (Widescreen). New TV systems support both 4:3 and 16:9 aspect ratio and can automatically switch between them.
Audio Video (A/V)	A term often used when discussing a channel on a TV receiver or on video equipment, which has been especially designed to accept VCR audio-video signals. This channel automatically activates special circuitry within the TV set to prevent picture distortion and skewing. It is also used for audio-video processors, which handle both types of signals.
CVBS	Composite Video Baseband Signal. In broadcast television this refers to the video signal, including the colour information and syncs.
Component Video Input (Y Pb Pr)	Component Video Input is a type of connection that uses a cinch-type connector to allow set top boxes or analog DVD players to connect a signal to the TV. By offering the cinch-type input (YPbPr) the primary colors, red, green and blue are connected from a set top box directly into the TV allowing for the signal to display on the screen.
HDTV	The generally agreed upon definition of HDTV is approximately twice the vertical and horizontal picture resolution of today's NTSC TV, which essentially makes the picture twice as sharp. HDTV also has a screen ratio of 16:9 as compared with most of today's TV screens, which have a screen ratio of 4:3. HDTV offers reduced motion artifacts (i.e. ghosting, dot crawl).
Progressive Scan	In Progressive Scanning all the horizontal scan lines are scanned on to the screen at one time. The HDTV Standards accept both Interlaced Scan and Progressive Scan broadcast and display methods.
Resolution	Resolution: A measurement of the finest (smallest) detail that is visible in a video image. TV Resolutions may be expressed as number of pixels in an image; or more commonly, As Total Number of (horizontally scanned) Lines used to create the image. Standard Digital TV Resolutions: SDTV: 480i - The picture is 704x480 pixels, 480p - The picture is 704x480 pixels. HDTV: 720p - The picture is 1280x720 pixels, 1080i - The picture is 1920x1080 pixels, 1080p - The picture is 1920x1080 pixels.
SPDIF	SPDIF (Sony and Philips Digital Interconnect Format) is highly recommended for high quality digital sound output. Note: SPDIF only supports at HDMI source.

WARNING concerning stationary images on the TV

Screen: Do not leave fixed images on the screen for extended periods of time. This can cause uneven aging of the LCD panel. Normal use of the TV should involve viewing of programs that have constantly moving or changing images. Do not leave moving images on screen for extended periods of time. Do not display the same images too frequently; if you do, subtle “ghost” images can be left on the LCD screen. Sources of stationary images may be Laser discs, video games, Compact Discs Interactive (CD-i), paused Digital Video Discs (DVDs) or video tapes.

Here are some common examples of stationary images:

- DVD menus list DVD content.
- Letter box black bars that appear at the top and bottom of the TV screen when a wide screen (16:9) movie is viewed on a TV with standard (4:3) aspect ratio. This occurs with some DVDs.
- Video game images and scoreboards
- Television station logos cause a problem if they are bright and stationary. Moving or low-contrast graphics are less likely to damage the picture tube.
- Stock market tickers may appear at the bottom of the TV screen if the TV programming covers this news.
- Shopping channel logos, pricing displays may be bright and may appear constantly during the show. These usually appear in the same location on the TV screen.

TV Location

- To avoid cabinet warping, cabinet color changes, and an increased chance of TV failure, do not place the TV where temperatures can become excessively hot -- for example, in direct sunlight or near a heating appliance.
- Allow a free flow of air around the TV.

Cleaning

- To avoid possible shock hazard, remove the TV's power cord from the electrical outlet before cleaning.
- Regularly dust the TV with a dry, non-scratching duster.
- When cleaning the TV, take care not to scratch or damage the screen surface. Avoid wearing jewelry or using anything abrasive. Do not use household cleaners. Wipe the screen with a clean cloth dampened with water. Use even, easy, vertical strokes when cleaning.
- Occasionally vacuum the vents on the rear of the TV.
- Never use thinners, insecticide sprays, or other chemicals on or near the cabinet. They may permanently blemish the cabinet.

Specification - TV

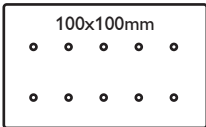
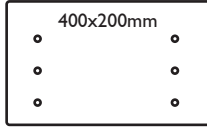
	26TA2800	32TA2800
PICTURE/ DISPLAY Aspect ratio Picture Enhancement	Wide screen Progressive Scan, 3D Comb Filter, Noise Reduction, Smart Picture (5 modes)	
SOUND Output Power (RMS) Sound Enhancement Sound Mode	2x5W Virtual Surround Mono, Stereo, Smart Sound (5 modes)	
CONVENIENCE	Auto Store, Full text, Sleep timer, Clock	
ON SCREEN DISPLAY LANGUAGE	English, Simplified Chinese (/93 model) English, Simplified Chinese, Thai, Arabic (/79/98 model)	
CONNECTIVITY Bottom Side	AC IN DVI-D is for 26TA2800/HDMI is for 32TA2800 PC IN - D-SUB, Audio input CVI 1 - Component (YPbPr), Audio L/R input CVI 2 - Component (YPbPr), Audio L/R input (only available for 32TA2800) AV - Video input, S-video, Audio L/R input 75Ω/RF Side AV - S-video, Audio L/R, Video input Earphone	
WEIGHT & DIMENSIONS Weight (incl. Packaging): Weight (excl. Packaging): Carton Dimension (WxHxD): Product Dimension (WxHxD)	15.98 kg/35.156 lbs 12.4 kg/27.28 lbs 898 x 243 x 582 mm 35.35" x 9.56" x 22.91" 661.8 x 511 x 240 mm 26.06" x 20.11" x 9.45"	19.2 kg/42.24 lbs 16 kg/35.2 lbs 1027 x 672 x 234 mm 40.43" x 26.45" x 9.21" 790.7 x 581.8 x 252.4 mm 31.13" x 22.91" x 9.94"
POWER Power Consumption Standby Power Consumption Mains Power	130W < 2W 100-240V, 60-50Hz	150W < 2W 100-240V, 60-50Hz
WALL MOUNT	 <p>Metric 4 (10mm) screws are needed for wall mounting (not included).</p>	 <p>Metric 6 (10mm) screws are needed for wall mounting (not included).</p>