

LCD TV

User`s Manual

20TAI600



English

中文

عربي

Model No.: _____
Serial No.: _____

PHILIPS

RETURN YOUR PRODUCT REGISTRATION CARD TODAY
TO GET THE VERY MOST FROM YOUR PURCHASE.

Registering your model with PHILIPS makes you eligible for all of the valuable benefits listed below, so don't miss out. Complete and return your Product Registration Card at once to ensure:

***Proof of Purchase**

Returning the enclosed card guarantees that your date of purchase will be on file, so no additional paperwork will be required from you to obtain warranty service.

***Product Safety Notification**

By registering your product, you'll receive notification - directly from the manufacturer - in the rare case of a product recall or safety defect.

***Additional Benefits of Product Ownership**

Registering your product guarantees that you'll receive all of the privileges to which you're entitled, including special money-saving offers.

PHILIPS

Congratulations on your purchase, and welcome to the "family!"

Dear PHILIPS product owner:

Thank you for your confidence in PHILIPS. You've selected one of the best-built, best-backed products available today. We'll do everything in our power to keep you happy with your purchase for many years to come.

As a member of the PHILIPS "family," you're entitled to protection by one of the most comprehensive warranties and outstanding service networks in the industry. What's more, your purchase guarantees you'll receive all the information and special offers for which you qualify, plus easy access to accessories from our convenient home shopping network.

Most importantly, you can count on our uncompromising commitment to your total satisfaction. All of this is our way of saying welcome - and thanks for investing in a PHILIPS product.

P.S. To get the most from your PHILIPS purchase, be sure to complete and return your Warranty Registration at once.

Know these **safety** symbols



This "bolt of lightning" indicates uninsulated material within your unit may cause an electrical shock. For the safety of everyone in your household, please do not remove product covering.



The "exclamation point" calls attention to features for which you should read the enclosed literature closely to prevent operating and maintenance problems.

WARNING: To reduce the risk of fire or electric shock, this apparatus should not be exposed to rain or moisture and objects filled with liquids, such as vases, should not be placed on this apparatus.

CAUTION: To prevent electric shock, match wide blade of plug to wide slot, fully insert.

ATTENTION: Pour éviter les choc électriques, introduire la lame la plus large de la fiche dans la borne correspondante de la prise et pousser jusqu'au fond.

For Customer Use

Enter below the Serial No. which is located on the rear of the cabinet. Retain this information for future reference.

Model No. _____
Serial No. _____

IMPORTANT SAFETY INSTRUCTIONS

READ BEFORE OPERATING EQUIPMENT

1. Read these instructions.
2. Keep these instructions.
3. Heed all warnings.
4. Follow all instructions.
5. Do not use this apparatus near water.
6. Clean only with a dry cloth.
7. Do not block any of the ventilation openings.
Install in accordance with the manufacturer's instructions.
8. Do not install near any heat sources such as radiators, heat registers, stoves, or other apparatus (including amplifiers) that produce heat.
9. Do not defeat the safety purpose of the polarized or grounding-type plug. A polarized plug has two blades with one wider than the other. A grounding type plug has two blades and third grounding prong. The wide blade or third prong are provided for your safety. When the provided plug does not fit into your outlet, consult an electrician for replacement of the obsolete outlet.
10. Protect the power cord from being walked on or pinched particularly at plugs, convenience receptacles, and the point where they exit from the apparatus.
11. Only use attachments/accessories specified by the manufacturer.
12.  Use only with a cart, stand, tripod, bracket, or table specified by the manufacturer, or sold with the apparatus. When a cart is used, use caution when moving the cart/apparatus combination to avoid injury from tip-over.
13. Unplug this apparatus during lightning storms or when unused for long periods of time.
14. Refer all servicing to qualified service personnel. Servicing is required when the apparatus has been damaged in any way, such as power-supply cord or plug is damaged, liquid has been spilled or objects have fallen into apparatus, the apparatus has been exposed to rain or moisture, does not operate normally, or has been dropped.
15. This product may contain lead and mercury. Disposal of these materials may be regulated due to environmental considerations. For disposal or recycling information, please contact your local authorities or the Electronic Industries Alliance: www.eiae.org
16. **Damage Requiring Service** - The appliance should be serviced by qualified service personnel when:
 - A. The power supply cord or the plug has been damaged;
 - B. Objects have fallen, or liquid has been spilled into the appliance;
 - C. The appliance has been exposed to rain
 - D. The appliance does not appear to operate normally or

exhibits a marked change in performance;

E. The appliance has been dropped, or the enclosure damaged.

17. **Tilt/Stability** - All televisions must comply with recommended international global safety standards for tilt and stability properties of its cabinet design.
 - Do not compromise these design standards by applying excessive pull force to the front, or top, of the cabinet which could ultimately overturn the product.
 - Also, do not endanger yourself, or children, by placing electronic equipment/toys on the top of the cabinet. Such items could unsuspectingly fall from the top of the set and cause product damage and/or personal injury.
18. **Wall or Ceiling Mounting** - The appliance should be mounted to a wall or ceiling only as recommended by the manufacturer.
19. **Power Lines** - An outdoor antenna should be located away from power lines.
20. **Outdoor Antenna Grounding** - If an outside antenna is connected to the receiver, be sure the antenna system is grounded so as to provide some protection against voltage surges and built up static charges. Section 810 of the National Electric Code, ANSI/NFPA No. 70-1984, provides information with respect to proper grounding of the mast and supporting structure, grounding of the lead-in wire to an antenna discharge unit, size of grounding connectors, location of antenna-discharge unit, connection to grounding electrodes, and requirements for the grounding electrode. See Figure below.
21. **Object and Liquid Entry** - Care should be taken so that objects do not fall and liquids are not spilled into the enclosure through openings.
22. **Battery Usage CAUTION** - To prevent battery leakage that may result in bodily injury, property damage, or damage to the unit:
 - Install all batteries correctly, with + and - aligned as marked on the unit.
 - Do not mix batteries (old and new or carbon and alkaline, etc.).
 - Remove batteries when the unit is not used for a long time.

Note to the CATV system installer: This reminder is provided to call the CATV system installer's attention to Article 820-40 of the NEC that provides guidelines for proper grounding and, in particular, specifies that the cable ground shall be connected to the grounding system of the building, as close to the point of cable entry as practical.

Example of Antenna Grounding as per NEC - National Electric Code

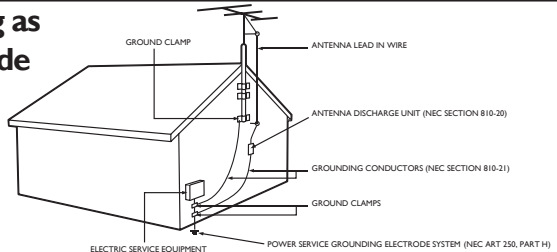

ADDITIONAL SAFETY PRECAUTIONS

- ENSURE that LCD TV stand is tightened properly to the set (See Quick Guide on the right way of tightening of the screw of the stand to the set. Improper tightening of screw may render the set unsafe.
- If LCD TV is installed on the wall, installation should be carried out by qualified servicemen. Improper or incorrect installation may render the set unsafe.
- Disconnect main plug when :
 - cleaning the TV screen, never use abrasive cleaning agents.
 - there is a lightning storm.
 - the set is left unattended for a prolonged period of time.
- Do not shift or move the LCD TV around when it is powered on.
- Do not touch, push or rub the surface of the LCD screen with any sharp or hard objects.
- When the surface of the LCD screen becomes dusty, wipe it gently with an absorbent cotton cloth or other soft material like chamois. DO NOT USE acetone, toluene or alcohol to clean the surface of the screen. These chemicals will cause damage to the surface.
- Wipe off water or saliva as soon as possible. These liquids can cause deformation and color fading of the LCD screen when left exposed for some time.
- Be careful of condensation when temperature changes occur. Condensation can cause damage to the LCD screen and electrically parts. After condensation fades, spots or blemishes will be present on the LCD screen.
- CAUTION information is located on the inside of the VESA cover (see diagram below). To read information, open the VESA cover.

POSITIONING THE LCD TELEVISION

- Place the LCD TV on a solid, sturdy base or stand. Be sure the stand is strong enough to handle the weight of the LCD TV.
- Try to leave at least 6" of space around each side of the LCD TV cabinet to allow for proper ventilation.
- Do not place the LCD TV near a radiator or other sources of heat.
- Do not place the LCD TV where it can be exposed to rain or excessive moisture.

RECYCLING PROCEDURE/END OF LIFE DISPOSAL

- To minimize harm to the environment, the batteries supplied with the LCD TV do not contain mercury or nickel cadmium. If possible, when disposing of batteries, use recycling means available in your area.
- The LCD TV uses materials that can be recycled. To minimize the amount of waste in the environment, check your area for companies that will recover used televisions for dismantling and collection of reusable materials, or contact your dealer for TV recycling tips.
- Please dispose of the carton and packing material through the proper waste disposal management in your area.

Introduction

Welcome/Registration of Your TV2
 IMPORTANT SAFETY INSTRUCTIONS 3
 PRECAUTIONS 4
 Table of Contents 5



Installation

Language Settings 6
 Auto Program (Setting Up Channels)7
 Manual Store of TV Channel 8
 Channel Setting 9
 Factory Reset 10
 Unfold the Base 11
 Installing LCD TV on the wall12
 Basic TV and Remote Control Operations13
 Remote Control14
 Timer Menu Controls..... 15



Picture Menu

TV Picture Menu Controls16



Sound Menu

TV Sound Menu Controls17



Features Menu

Smart Picture Control 18
 Smart Sound Control18
 Auto Lock 19
 Auto Lock Access Code 19
 Auto Lock Program20
 Using The Picture Format21
 Teletext 22



PC Mode

PC Picture Controls23
 PC Audio Controls 24
 Using PC PIP (Picture In Picture) Feature25
 Setting Up The PC Mode 26



General Information

Trouble Shooting Tips 27
 Care And Cleaning 28
 Index 29

Here are a few of the special features of your new LCD TV.

Audio/Video In Jacks: Use to quickly connect other equipment to your LCD TV.

Automatic Channel Programming (Auto Program): Quick and easy setup of available channels.

On-screen Menus: Helpful messages (in English or Simplified Chinese) for setting TV controls.

Remote Control: Works your LCD TV features.

Sleep Timer: Turns off the LCD TV within an amount of time you specify (15-240 minutes from the current time).

AutoLock: Lets you block viewing of certain TV channels if you do not want your children viewing inappropriate material.

Standard broadcast (VHF/UHF) or Cable TV channel capability.

Stereo capability: Includes a built-in amplifier and twin-speaker system, allowing reception of TV programs broadcast in stereo.

Treble, Bass, and Balance: Enhance the LCD TV's sound.

NOTE: This manual covers different versions and models. Not all features described in this manual will match those of your LCD TV. This is normal and does not require you contacting your dealer or requesting service.

END-OF-LIFE DISPOSAL

Your new LCD TV and its packaging contain materials that can be recycled and reused. Specialized companies can recycle your product to increase the amount of reusable materials and minimize the amounts that need to be properly disposed.

Your product also uses batteries that should not be thrown away when depleted, but should be handed in and disposed off as small chemical waste.

When you replace your existing equipment, please find out about the local regulations regarding disposal of your old television, batteries, and packing materials.

When operate **INSTALL** function, the access code window will appear on the screen. Press default code (0711) or your personal code setting to enter this menu.

LANGUAGE SETTINGS

For English, Simplified Chinese -speaking TV owners, an onscreen **LANGUAGE** option is present. The **LANGUAGE** control enables you to set the TV's onscreen menu to be shown in English or Simplified Chinese.

- 1 Press the **MENU** button on the remote control to open the onscreen menu.
- 2 Press the **CURSOR DOWN** button to highlight the **INSTALL** menu.
- 3 Press the **CURSOR RIGHT** button to Highlight **LANGUAGE**.
- 4 Press the **CURSOR RIGHT** button to enter **LANGUAGE**. Press **CURSOR DOWN** button to select English or Simplified Chinese (中文), then press the **CURSOR RIGHT** to confirm.
- 5 Press the **MENU** button repeatedly to clear the menu from the screen.

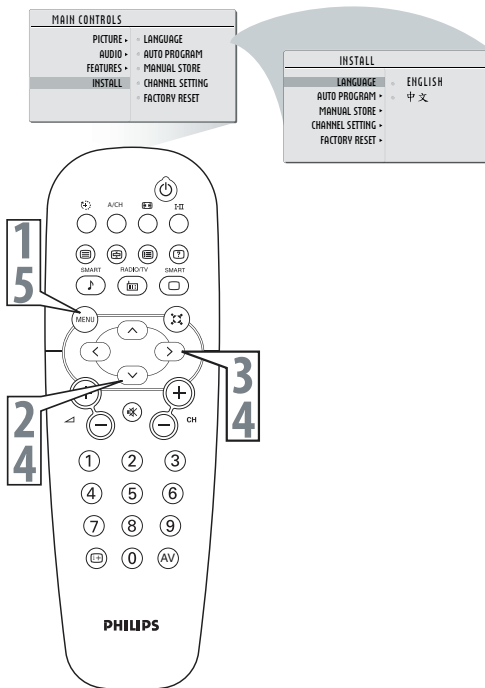

HELPFUL HINT

Remember, the **LANGUAGE** control makes only the TV's onscreen **MENU** items appear in English or Simplified Chinese text. It does not change the other onscreen text features.



Your LCD TV can automatically set itself for local area (or cable TV) channels. This makes it easy for you to select only the TV stations in your area by pressing the CH (+) or CH (-) button.

- 1** Press the MENU button on the remote control to show the onscreen menu.
- 2** Press the CURSOR DOWN button to highlight the INSTALL menu.
- 3** Press the CURSOR RIGHT button to enter the INSTALL menu.
- 4** Press the CURSOR DOWN button to highlight the AUTO PROGRAM control.
- 5** Press the CURSOR RIGHT button to start the AUTO PROGRAM scanning of channels.
- 6** Press the MENU button repeatedly to clear the menu from the screen, after AUTO STORE has finished.

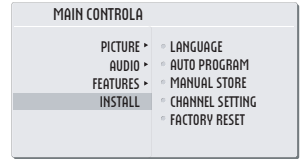
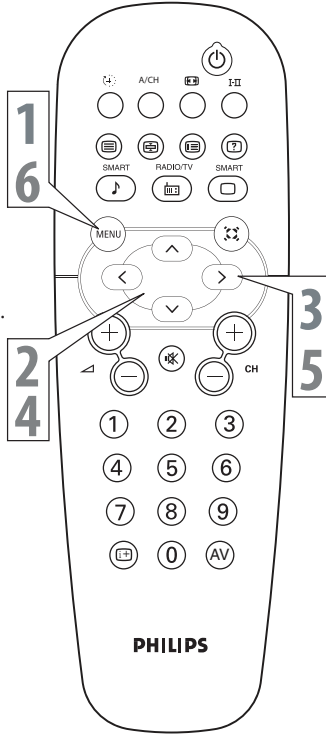

HELPFUL HINT

- Immediately after unpacking and plugging in your new television, run the auto program function to set up the TV for the broadcast or cable channels available in your area. If you do not run the auto program function to set up the channels , your television may not operate properly.
- After you've run Auto Program, check out the results. Press the CH(+) or the CH(-) button and see which channels you can select.
- Remember, an antenna or cable TV signal must first be connected to your LCD TV.



You can also choose to tune your TV channels. Manual tuning allows you to store each programme manually.

- 1 Press the MENU button on the remote control to show the onscreen menu.
- 2 Press the CURSOR DOWN button to highlight the INSTALL menu, then press CURSOR RIGHT to enter.
- 3 Select the MANUAL STORE, then press the CURSOR RIGHT button to activate auto search channel frequency or press number button to show your desired channel frequency.
- 4 After the channel frequency confirmed, select PROGRAM NO. by pressing CURSOR DOWN.
- 5 Press the number button or CURSOR RIGHT/LEFT to give the channel number.
- 6 If the channel reception is not satisfactory, press CURSOR DOWN button to highlight the FINETUNE. then press CURSOR RIGHT / LEFT to adjust.
Note: If the channel reception is satisfactory, please go to step 7.
- 7 Press CURSOR DOWN to highlight STORE function. Press CURSOR RIGHT to confirm stored.
- 8 Press the MENU button repeatedly to clear the menu from the screen.

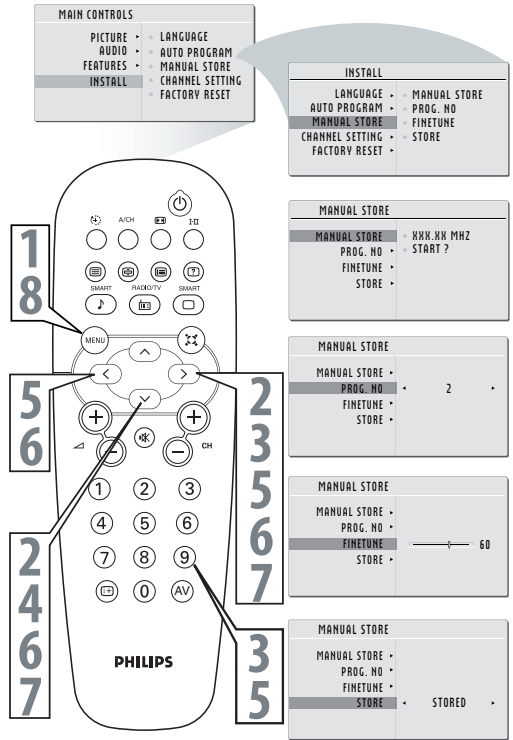



Channel setting to set all channel related functions.

- 1 Press the Menu button to open the onscreen menu.
- 2 Press the CURSOR DOWN button to highlight the INSTALL menu, then press CURSOR RIGHT to enter.
- 3 Press the CURSOR DOWN button to enter the CHANNEL SETTING menu, then press CURSOR RIGHT to enter.

- 4 Press CURSOR DOWN to select CHANNEL EDIT, CHANNEL SWAP, NAME EDIT, or CHANNEL SORT. Press CURSOR RIGHT to enter:

A CHANNEL EDIT
In CHANNEL column, press CURSOR RIGHT / LEFT to select the channel that you want to add or remove.

In SKIPPED column, press CURSOR RIGHT / LEFT to select ACTIVE (to add) or SKIPPED (to delete) the channel you selected.

B CHANNEL SWAP
Press CURSOR RIGHT / LEFT to choose channel when you are in FROM or TO column.

Press CURSOR RIGHT to activate EXCHANGE.

C NAME EDIT
Press CURSOR RIGHT / LEFT to select channel.

Press CURSOR UP /DOWN to edit the channel name.

D CHANNEL SORT
Press CURSOR RIGHT to sort the channel by channel name.

5 Press the MENU button repeatedly to clear the menu from the screen.

MAIN CONTROLS	
PICTURE ▾	LANGUAGE
AUDIO ▾	AUTO PROGRAM
FEATURES ▾	MANUAL STORE
INSTALL ▾	CHANNEL SETTING
	FACTORY RESET

INSTALL	
LANGUAGE ▾	CHANNEL EDIT
AUTO PROGRAM ▾	CHANNEL SWAP
MANUAL STORE ▾	NAME EDIT
CHANNEL SETTING ▾	CHANNEL SORT
FACTORY RESET ▾	

CHANNEL SETTING	
CHANNEL EDIT ▾	CHANNEL
CHANNEL SWAP ▾	SKIPPED
NAME EDIT ▾	
CHANNEL SORT ▾	

CHANNEL EDIT	
CHANNEL ▾	2
SKIPPED ▾	

CHANNEL EDIT	
CHANNEL ▾	ACTIVE
SKIPPED ▾	SKIPPED

MAIN CONTROLS	
PICTURE ▾	LANGUAGE
AUDIO ▾	AUTO PROGRAM
FEATURES ▾	MANUAL STORE
INSTALL ▾	CHANNEL SETTING
	FACTORY RESET

INSTALL	
LANGUAGE ▾	CHANNEL EDIT
AUTO PROGRAM ▾	CHANNEL SWAP
MANUAL STORE ▾	NAME EDIT
CHANNEL SETTING ▾	CHANNEL SORT
FACTORY RESET ▾	

CHANNEL SETTING	
CHANNEL EDIT ▾	CHANNEL
CHANNEL SWAP ▾	NAME
NAME EDIT ▾	
CHANNEL SORT ▾	

CHANNEL SETTING	
CHANNEL EDIT ▾	FROM
CHANNEL SWAP ▾	TO
NAME EDIT ▾	EXCHANGE
CHANNEL SORT ▾	

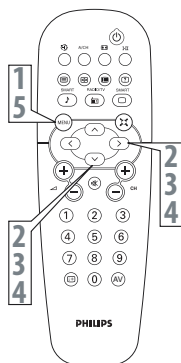

CHANNEL SETTING	
CHANNEL EDIT ▾	CHANNEL
CHANNEL SWAP ▾	NAME
NAME EDIT ▾	
CHANNEL SORT ▾	

CHANNEL SETTING	
CHANNEL EDIT ▾	
CHANNEL SWAP ▾	
NAME EDIT ▾	
CHANNEL SORT ▾	SORT



Your TV can be reset to the original factory settings by performing the following steps.

- 1 Press the MENU button on the remote control to see the onscreen menu.
- 2 Press the CURSOR DOWN button to highlight the INSTALL menu, then press CURSOR RIGHT to enter.
- 3 Press the CURSOR DOWN button repeatedly to highlight the FACTORY RESET control, then press CURSOR RIGHT to enter.
- 4 Press CURSOR DOWN to select "YES" to reset the original factory settings.
- 5 Press the MENU button repeatedly to clear the menu from the screen.

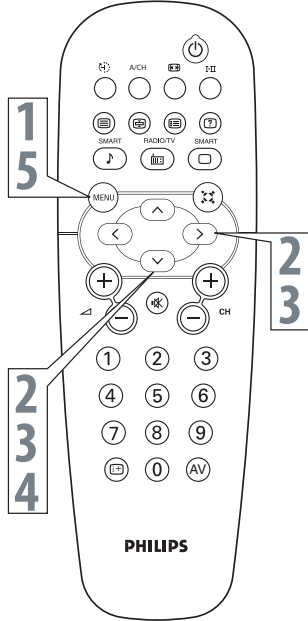
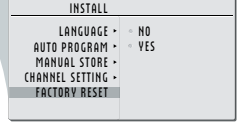
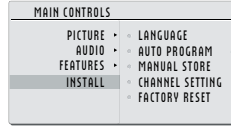

HELPFUL HINT

If you reset the TV to the factory settings, all your present setting on picture, audio, and other feature settings will be erased and replaced by the manufacture's default settings. However, your AutoLock access code will not be erased. Please refer to page 19 for details.



Before proceed to install your new LCD TV, please follow the steps and diagrams as shown to familiarize yourself with the correct and safe way of unfolding the base.

- 1** Place the set facing down on a flat surface with a protective sheet.
- 2** Unfold the base following the direction as shown on the diagram.
- 3** Place the set upright, you LCD TV is now ready for install.

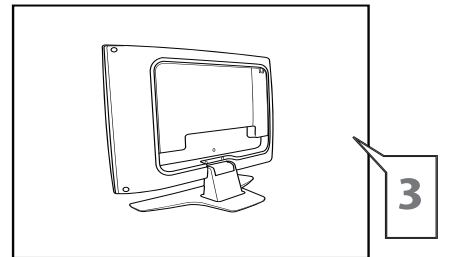
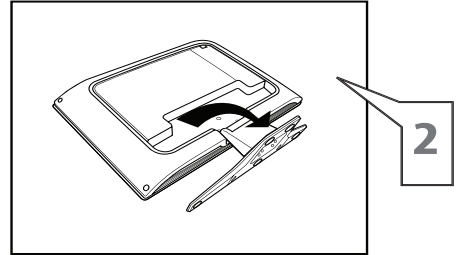
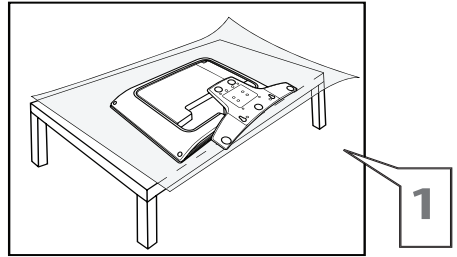

HELPFUL HINT

Expanding the base requires a degree of force; please use sufficient force to unfold the base.

When unfolding the base, place the TV on a flat, sturdy surface before expanding the base.



Vesa Complied Mounting

The stand of your LCD TV complies with VESA standard, if you intend to install the LCD TV on the wall, please consult a professional technician for proper installing.

The manufacture accepts no liability for installations not performed by professional technician.

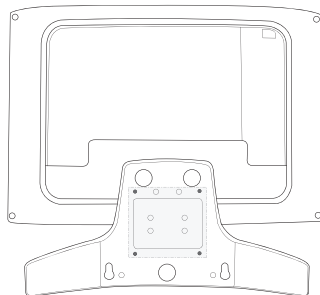
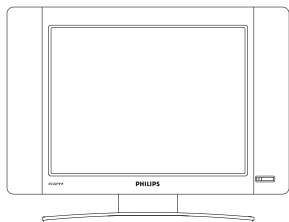

20" : 100x100 mm

Easy wall mounting

Smart tips

I. Use the full scale template to mark on the wall the horizontal distance between the two mounting screws.

Note:

- The surface for mounting area must be flat and larger then the pedestal.
- The wall must support a pull force of 10 kg for each screw.

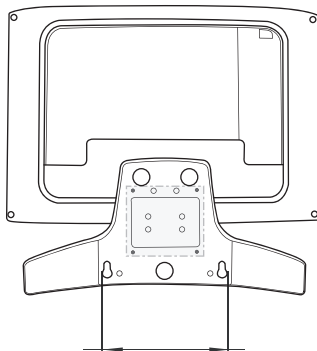

20" : 190 mm

WARNING !

- * Read all instructions carefully before mounting!
- * Correct assembly is essential. The maximum allowed wight of the LCD Display is 8.5 kg / 18.7 lbs (20").
- * The assembly materials (not supplied) are only suitable for attachment to solid wood, brick or concrete walls.
- * For wood walls: Drill each hole 3.6 mm in diameter and 20 mm in depth.
- * To avoid possible injury, do not mount it above a sofa or bed.

The manufacturer accepts no liability for improper installations or installations not performed in accordance with these instructions.



TELEVISION AND REMOTE CONTROL

- 1** Plug the DC adapter into the DC IN 16V jack on the LCD TV. Plug the power cable into an outlet.
- 2** Press POWER to turn on the LCD TV.
- 3** Press VOLUME + to increase the sound level, or press VOLUME- to decrease the sound level.
- 4** Press CHANNEL +/- to select channels.
- 5** Point the remote control toward on the front of the LCD TV when operating the LCD TV with the remote control.

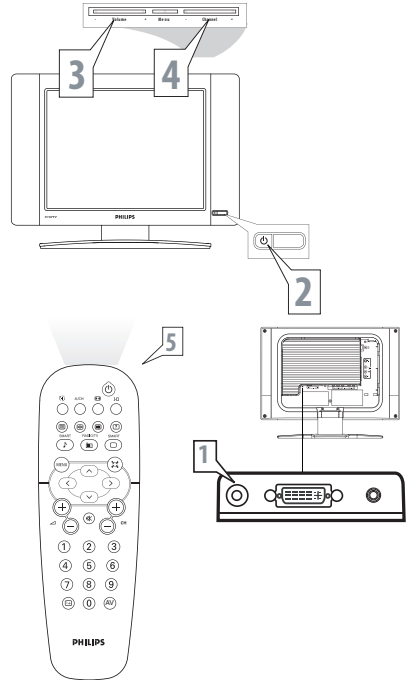

BATTERY INSTALLATION

- 6** Remove the battery compartment lid on the button of the remote control.
- 7** Place lithium cell in the remote control. Be sure the (+) and (-) ends of the batteries line up as marked inside the battery (AA) compartment.
- 8** Reattach the battery compartment lid.

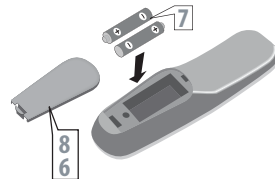



Previous Channel button

Press to go to previously selected channel.

Sleep button

Press to set the LCD TV to turn itself off within a certain time.



Teletext keys

Smart Sound button

Press repeatedly to select among the 4 settings; Personal, Voice, Music, or Theatre.

Menu button

Press to activate onscreen menu, back to previous level inside the onscreen menu, also press to exit the onscreen menu.

Volume button

Press to increase or decrease the sound level.

Mute button

Press to eliminate or restore the LCD TV sound. Mute will appear on the screen when the sound is muted.

Number buttons

Press the number buttons for direct access to the TV channels. For a 2 digit channel, enter the 2nd digit after enter 1st digit.

Information button

Press to see the current channel number on the TV screen.

Unused key

Power button

Press to turn the LCD TV on or off.

Picture Format button

Press the FORMAT button repeatedly to toggle among the three screen format sizes; 4:3, EXPAND 4:3, COMPRESS 16:9.

I-II button/Sound mode

Press repeatedly to select Mono, Stereo, Dual I, Dual II, Nicam Mono, Nicam Stereo, Nicam Dual I, Nicam Dual II.

Smart Picture button

Press repeatedly to select either Personal, Rich, Natural, Soft, or Multimedia picture setting.

Virtual Surround button

Adds greater depth and dimension to TV sound. Select from ON or OFF.

Cursor Buttons

(Left, Right, Up, Down)

Press these buttons to highlight, select, and adjust items on the TV's on screen menu.

Channel button

Press to adjust the channel up or down.

AV button

Press to select the video input source: PC, TV, AV, S-Video, HD.

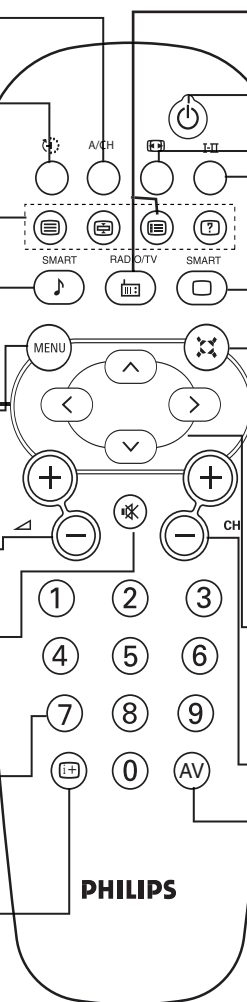

PHILIPS



- 1 Press the SLEEP button on the remote control to show the onscreen menu..
- 2 Press the SLEEP button repeatedly to select your requiring sleep timing.

SLEEP OFF

SLEEP 15 MIN.

SLEEP 240 MIN.

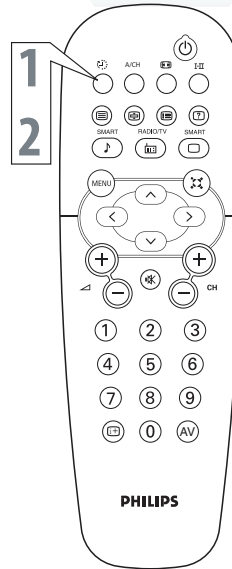

HELPFUL HINT

IMPORTANT
For the Timer to function, the set must not be turned off. Once the set is turned off, the Timer is disabled.



To adjust your LCD TV picture, select a channel and follow these steps.

- 1 Press the MENU button to see the onscreen menu.
- 2 When PICTURE menu is highlighted, press the CURSOR RIGHT button to enter the PICTURE menu.
- 3 Press the CURSOR DOWN to choose the item you want to adjust: Smart Picture, Brightness, Color, Contrast, Sharpness.

Smart Picture: Please refer to page 18, for details on Smart Picture Settings.

Brightness: Adjust to brighten the dark parts of the picture. This appears to add white to the color.

Contrast: Adjust to “sharpen” the Picture quality. The black portions of the picture become richer in darkness and the white become brighter.

Color: Adjust to add or reduce color.

Sharpness: Adjust to improve detail.

- 4 Press the CURSOR RIGHT or CURSOR LEFT button to adjust the item.
- 5 Press the CURSOR DOWN button to select and adjust other picture controls.
- 6 Press MENU repeatedly to remove the menu from the screen.

MAIN CONTROLS	
PICTURE	SMART PICTURE
AUDIO	BRIGHTNESS
FEATURES	CONTRAST
INSTALL	COLOR
	SHARPNESS

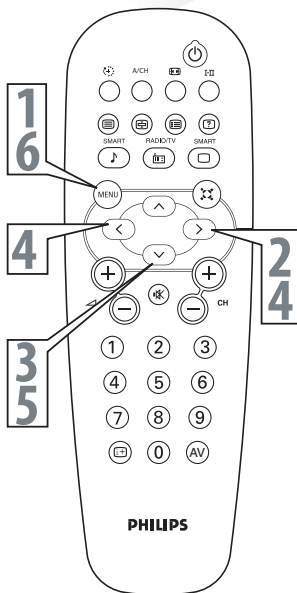

PICTURE	
SMART PICTURE	PERSONAL
BRIGHTNESS	RICH
CONTRAST	NATURAL
COLOR	SOFT
SHARPNESS	MULTIMEDIA

PICTURE	
SMART PICTURE	BRIGHTNESS
BRIGHTNESS	60
CONTRAST	
COLOR	
SHARPNESS	

PICTURE	
SMART PICTURE	BRIGHTNESS
BRIGHTNESS	60
CONTRAST	
COLOR	
SHARPNESS	

PICTURE	
SMART PICTURE	BRIGHTNESS
BRIGHTNESS	60
CONTRAST	
COLOR	
SHARPNESS	

PICTURE	
SMART PICTURE	BRIGHTNESS
BRIGHTNESS	60
CONTRAST	
COLOR	
SHARPNESS	

HELPFUL HINT

Any adjustment of Brightness, Contrast, Color or Sharpness will be stored into PERSONAL at Smart Picture section.



To adjust your LCD TV Sound, select a channel and follow these steps.

1 Press the MENU button to see the menu.

2 Press the CURSOR DOWN button to highlight the AUDIO menu.

3 Press the CURSOR RIGHT button to enter the AUDIO menu.

4 Press the CURSOR DOWN button to choose the item you want to adjust: Smart Sound, Settings, Incredible Surround, AVL.

Smart Sound: Please refer to page 18 for details on Smart Sound Settings.

Settings: Allows you to adjust Treble, Bass, and Balance of the sound.

Virtual Surround: Adds greater depth and dimension to TV sound. Select from OFF or ON.

AVL (Auto Volume Leveler): When On, AVL will level out the sound being heard when sudden changes in volume occur during commercial breaks or channel changes.

MAIN CONTROLS	
PICTURE	SMART SOUND
AUDIO	SETTINGS
FEATURES	VIRTUAL SURROUND
INSTALL	AVL

AUDIO	
SMART SOUND	PERSONAL VOICE
SETTINGS	MUSIC
VIRTUAL SURROUND	THEATRE
AVL	

AUDIO	
SMART SOUND	TREBLE
SETTINGS	BASS
VIRTUAL SURROUND	BALANCE
AVL	

AUDIO	
SMART SOUND	OFF
SETTINGS	ON
VIRTUAL SURROUND	
AVL	

AUDIO	
SMART SOUND	OFF
SETTINGS	ON
VIRTUAL SURROUND	
AVL	

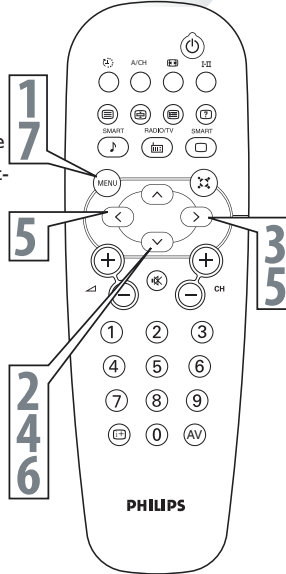

5 Press the CURSOR RIGHT or CURSOR LEFT button to adjust the item.

6 Press the CURSOR DOWN button to select and adjust other sound controls.

7 Press MENU repeatedly to remove the menu from the screen.

HELPFUL HINT

- Any adjustment of Treble and Bass will be stored into PERSONAL at Smart sound.
- If Stereo is not presented on a selected show and the TV is placed in Stereo mode, the sound coming from TV will remain in Mono mode.



SMART PICTURE CONTROL

Whether you're watching a movie or a video game, your LCD TV has video control preset that will match with your current program source or content. Smart Picture quickly resets your TV's video controls for a number of different types of programs and viewing conditions that you may have in your home. The Personal, Rich, Natural, Soft, and Multimedia, Smart Picture controls have been preset at the factory to easily adjust the TV's brightness, color, picture, sharpness, and color temperature levels. In the Personal Smart picture mode you can create your own preferred video settings.

- 1** Press the SMART PICTURE button on the remote control. The current Smart Picture setting will appear on the screen.
- 2** Press the SMART PICTURE button repeatedly to select either Personal, Rich, Natural, Soft, or Multimedia.

Note:The settings of the Personal Smart picture mode can be adjusted in picture options within the onscreen menu. The Personal mode is the only mode which can be adjusted by the user via the onscreen picture control menu.

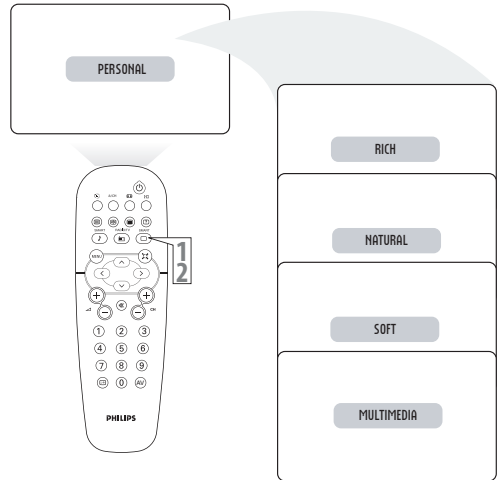

SMART SOUND CONTROL

Smart Sound allows you to select from three user presets and a personal mode that you set according to your own preferences through the on-screen Sound menu. The four user presets (Personal, Voice, Music, and Theatre) enable you to tailor the TV sound so as to enhance the particular program you are watching. Following these steps to select any of the options.

- 1** Press the SMART SOUND button on the remote control. The current Smart Sound setting will appear on the screen.
- 2** Press the SMART SOUND button repeatedly to toggle among the four setting: Personal, Voice, Music, or Theatre.

Note: The settings of the Personal Smart sound mode can be adjusted in sound control within the onscreen menu. The Personal mode is the only mode which can be adjusted by the user via the onscreen sound control menu.

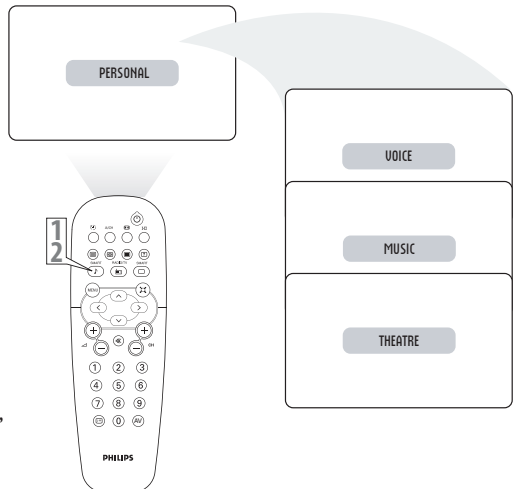



The **AUTO Lock** feature allow you to lock channels, and prevent your children from watching unsuitable content of programmes.

AUTO Lock offers various BLOCKING controls from which to choose:

Access Code - An Access Code must be set to prevent children from unblocking questionable or censored programming set by their parents.

Lock Program - Select the TV channel you want to lock.

Change Code - To change your access code or overwriting.

Clear All - To unlock all locked channels and programming.

AUTO LOCK ACCESS CODE



Over the next few pages you'll learn how to block programs and understand the rating terms for certain broadcasts. First, set an access code.

- 1 Press the **MENU** button to see the onscreen menu.
- 2 Press the **CURSOR DOWN** button to highlight the **FEATURES** menu, then press **CURSOR RIGHT** to enter.
- 3 Press the **CURSOR DOWN** button to select **AUTO LOCK**.
- 4 Press the **CURSOR RIGHT** button **CHANGE CODE** will appear on the screen.
- 5 Enter a four-digit code using the **Number** buttons. The screen will prompt you to confirm the code you just entered. Enter your same new code again.
- 6 Press **MENU** repeatedly to remove the menu from the screen.

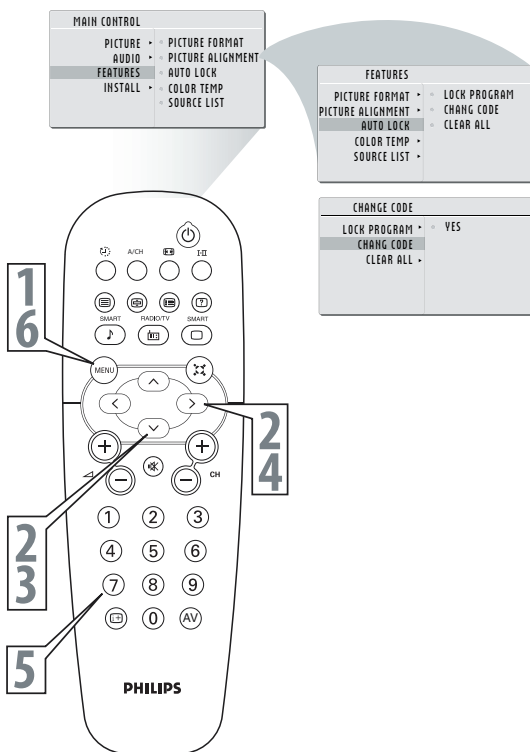

HELPFUL HINT

Remember that 0711 is the default AutoLock code. If your access code has been changed by someone other than you (a child, for example) or you have forgotten the code, you can always get in by inputting the default code.



After your personal access code has been set (see the previous page), you are ready to select the channels or inputs you want to block out or censor.

- 1 Press the MENU button to see the onscreen menu.
- 2 Press the CURSOR DOWN button to highlight the FEATURES menu, then press CURSOR RIGHT to enter.
- 3 Press the CURSOR DOWN button to select AUTO LOCK, then press the CURSOR RIGHT to enter.
- 4 Use the Number buttons to enter your access code.
- 5 Press the CURSOR RIGHT/LEFT button to block current selected channel or CURSOR RIGHT/LEFT button to unblock a channel.
- 6 Press MENU repeatedly to remove the menu from the screen.

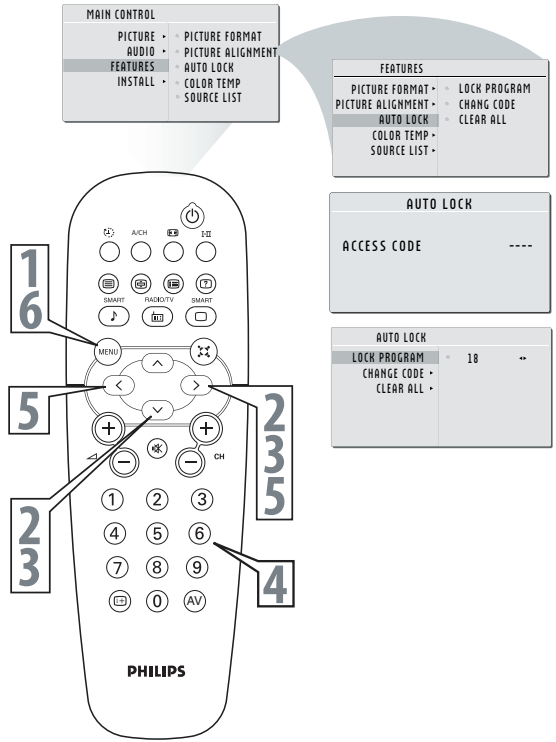

Note: You can block additional channels by using Number buttons to jump to another channel.



You can change the picture format size to match the type of program you are watching. Select the normal 4:3, EXPAND 4:3, or COMPRESS 16:9.

- 1 Press the MENU button to see the onscreen menu.
- 2 Press the CURSOR DOWN button to highlight the FEATURES menu, then press CURSOR RIGHT to enter.
- 3 Press the CURSOR DOWN button to highlight the PICTURE FORMAT menu, then press CURSOR RIGHT to enter
- 4 Press the CURSOR DOWN button to select the PICTURE FORMAT, then press CURSOR RIGHT to confirm your choice.

Note: Press the FORMAT button repeatedly to toggle among the three screen format sizes; 4:3, EXPAND 4:3, or COMPRESS 16:9.

- 5 Press MENU repeatedly to remove the menu from the screen.

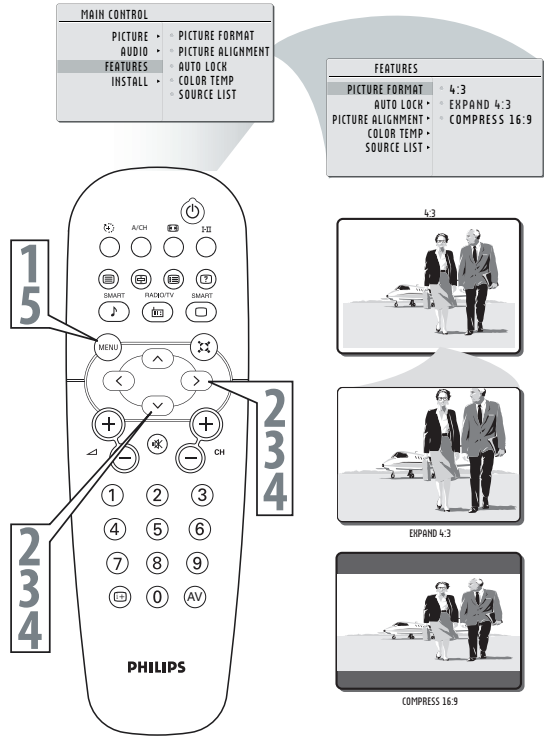

HELPFUL HINT

1. For 720p/1080i, the default picture format will be 4:3 at HD modes. And the picture format function will not be accessible.
2. For 576i/576p, the picture format function is accessible at HD modes.
3. For PC mode, the default picture format will be 4:3 and picture format function will not be accessible.



Teletext is an information system broadcast by certain channels which can be consulted like a newspaper. It also offers access to subtitles for viewers with hearing problems or who are not familiar with the transmission language (cable networks, satellite channels, etc.).

Press:**You will obtain:**

Teletext call



This is used to call or exit teletext mode. The summary appears with a list of items that can be accessed. Each item has a corresponding 3 digit page number. *If the channel selected does not broadcast teletext, the indication 100 will be displayed and the screen will remain blank (in this case, exit teletext and select another channel)*

Selecting a page

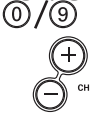

Enter the number of the page required using the 0 to 9 or CH +/- keys.

Example: page 120, enter 120.

The number is displayed top left, the counter turns and then the page is displayed. Repeat this operation to review another page.

If the counter continues to search, this means that the page is not transmitted. Select another number.

Direct access to the items



Coloured areas are displayed at the bottom of the screen. The 4 coloured keys are used to access the items or corresponding pages.

The coloured areas flash when the item or the page is not yet available.

Content



This returns you to the contents page (usually page 100).

Stop sub-page acquisition



Certain pages contain sub-pages which are automatically displayed successively. This key is used to stop or resume sub-page acquisition. The indication appears top left.

The indication appears top left.

Hidden information



To display or hide the concealed information (games solutions).

Enlarge a page



This allows you to display the top or bottom part of the page and then return to normal size.



This TV can also be used as a PC Monitor. A PC video signal must be present or the TV will go into standby mode. The PC Picture controls allow you to adjust the picture.

Note: Make sure you are in PC mode.

- 1 Press the MENU button on the remote control to see the onscreen menu.
- 2 When the PICTURE menu is highlighted, Press the CURSOR RIGHT button to enter the PICTURE menu.
- 3 Press the CURSOR DOWN button to highlight the item that you would like to adjust.
 - Color Temp:** Adjust the color temperature of the picture. Select from Normal, Cool, or Warm.
 - Brightness:** Adjust to brighten the darkest parts of the picture.
 - Contrast:** Adjust to “sharpen” the Picture quality. The black portions of the picture become richer in darkness and the white become brighter.
 - Auto Adjust:** The LCD Monitor will automatically adjust to the best image position, phase, and clock setting.
 - Manual Adjust:** The Manual Adjust control allow you to manually fine tune the image as it appears on the screen.
 - Phase-**eliminates the horizontal interfering lines.
 - Clock-**eliminates the vertical interfering lines.
 - Horizontal-**adjust the horizontal placement of the picture.
 - Vertical-**adjust the vertical placement of the picture.
- 4 Press the CURSOR RIGHT/LEFT button to adjust the item.
- 5 Press MENU repeatedly to remove the menu from the screen.

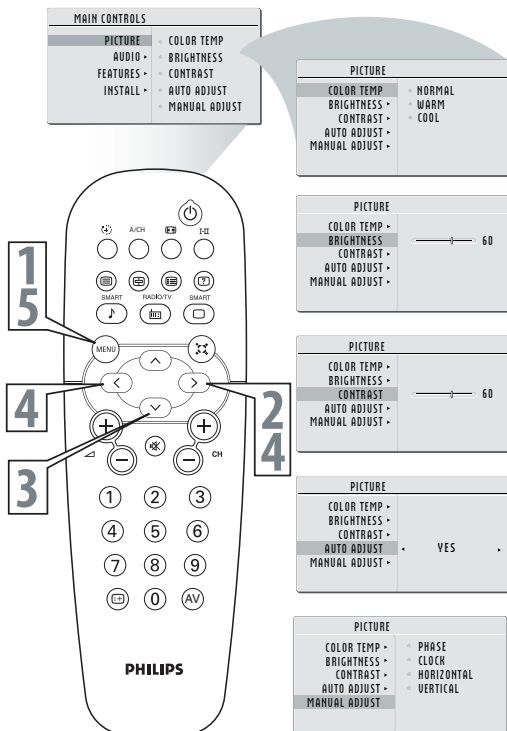

HELPFUL HINT

1. To adjust other items repeat steps 3 and 4.
2. Color Temp can also be activated by pressing Smart Picture button on your Remote Control.

If you are willing to reset adjustment back to original value, please enter to Factory Reset in Install menu.



This TV can also be used as a PC Monitor. A PC video signal must be present or the TV will go into standby mode. The AUDIO controls allow you to adjust the sound.

Note: Make sure you are in PC mode.

- 1** Press the MENU button on the remote control to show the onscreen menu.
- 2** Press the CURSOR DOWN button to highlight the AUDIO menu, then press CURSOR RIGHT to enter.
- 3** Press the CURSOR DOWN button to highlight the item that you would like to adjust:
- 4** **Smart Sound:** Allows you to select from 3 factory-set controls and a personal control. The 4 factory-set controls (Personal, Voice, Music, Theatre) enhance the particular program you are watching.
- Settings:** Allows you to adjust Treble, Bass, and Balance of the Sound.
- Virtual Sound:** Adds greater depth and dimension to PC sound.
- AVL (Auto Volume Leveler)-** When ON, AVL will level out the sound being heard when sudden changes in volume occur during commercial breaks or channel changes.
- 5** Press CURSOR RIGHT to enter the item you would like to adjust. Press the CURSOR RIGHT or CURSOR LEFT button to adjust.
- 6** Press MENU repeatedly to remove the menu from the screen.

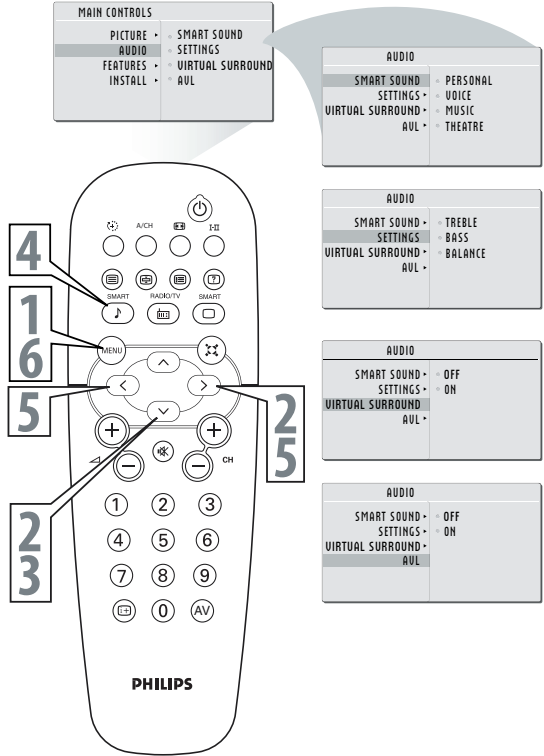

HELPFUL HINT

To adjust other items repeat steps 4 and 5.



PIP (Picture-in-Picture) feature allows you to call up a subscreen when you are using your TV as a monitor.

Note: Make sure you are in PC mode.

- 1 Press the MENU button to see the onscreen menu.
- 2 Press CURSOR DOWN button to highlight the FEATURES menu.
- 3 Press the CURSOR RIGHT button to enter the FEATURES menu.
- 4 Press the CURSOR RIGHT button to enter the PIP menu.
- 5 Press the CURSOR DOWN buttons to highlight the item that you would like to adjust.

SIZE: Turn off and set the size of PIP. You can choose your preferred size of small, large, or PBP (Picture Beside Picture).

Video: Select video source of PIP from TV, AV, S-Video or HD.

Audio: Select audio source of PIP or PC.

Display: Select which corner of the position of PIP.

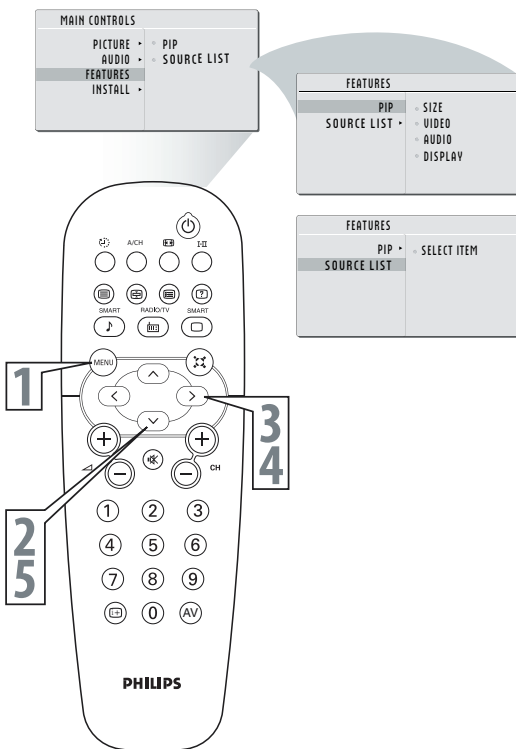

HELPFUL HINT

PIP windows with HD video source can only support up to 480i (SD)/576i video signal.

**20TA1600 (20" LCD TV)**

No	Resolution	Mode	V. Frequency (Hz)	H. Frequency (kHz)
1	640 x 480	VGA VESA 60	59.940	31.469



No Power

- Check the TV power cord. Unplug the TV, wait 10 seconds, then reinsert the plug into the outlet and push the **POWER** button again.
- Check that the outlet is not on a wall switch.
- Be sure the fuse is not blown on the AC power strip, if one is being used.

No Picture

- Check antenna/cable connections. Are they properly secured to the TV's ANT75Ω plug?
- Try running the Auto Program feature to find all available channels.
- Press the **AV** button on the remote to make sure the correct signal source is selected.
- If using an accessory device, be sure that it is functioning properly.
- If in PC Mode, a video signal **MUST BE** present or the TV will turn off.

No Sound

- Check the **VOLUME** buttons.
- Check the **MUTE** button on the remote control.
- If you're attempting to hook up auxiliary equipment, check the audio jack connections.

No AV Signal

- Check whether AV and S-Video sockets connected simultaneously. If they are, disconnect the S-Video socket. AV signal automatically overrides the S-Video signal if both sockets are connected simultaneously.

S-VHS Color Becomes Faint

- Unplug socket for S-Video connection. Reconnect the S-Video socket of the TV carefully to the VCR socket.

TV Only Produces MONO Sound

- If using a cable box with RF only type connections, the signal coming from the cable box will be produced in **MONO** only.
- Check Sound control setting. Change setting to Stereo.

Remote Does Not Work

- Check the batteries. Place lithium cell in the remote. Be sure the (+) and (-) ends of the batteries line up as marked inside the battery compartment.
- Clean the remote control and the remote control sensor window on the TV.
- Check the TV power cord. Unplug the TV, wait 10 seconds, then reinsert the plug into the outlet and push the **POWER** button again.
- Be sure the fuse is not blown on the AC power strip, if one is being used.
- Check to be sure the TV outlet is not on a wall switch.
- Be sure that the remote is in the correct operating mode.
- Be sure the remote is pointed at the Remote Sensor Window on the TV. See page 2 of the Quick Use Guide for details.

TV Displays Wrong Channel or No Channels Above 13

- Repeat channel selection.
- Add the desired channel numbers (using the **CHANNEL EDIT** control) into the TV's memory.
- Run the Auto Program feature to find all available channels.

**WARNING** concerning stationary images on the TV

Screen: Do not leave fixed images on the screen for extended periods of time. This can cause uneven aging of the LCD panel. Normal use of the TV should involve viewing of programs that have constantly moving or changing images. Do not leave still images on screen for extended periods of time. Do not display the same images too frequently; if you do, subtle “ghost” images can be left on the LCD screen. Sources of stationary images may be Laser discs, video games, Compact Discs Interactive (CD-i), or paused Digital Video Discs (DVDs) or video tapes.

Here are some common examples of stationary images:

- DVD menus list DVD content.
- Letterbox black bars appear at the top and bottom of the TV screen when a wide screen (16:9) movie is viewed on a TV with standard (4:3) aspect ratio. This is available with some DVDs.
- Video game images and scoreboards
- Television station logos cause a problem if they are bright and stationary. Moving or low-contrast graphics are less likely to damage the picture tube.
- Stock market tickers may appear at the bottom of the TV screen if the TV programming covers this news.
- Shopping channel logos, pricing displays may be bright and may appear constantly during the show. These are usually in the same location on the TV screen.

TV Location

- To avoid cabinet warping, cabinet color changes, and an increased chance of TV failure, do not place the TV where temperatures can become excessively hot (for example, in direct sunlight or near a heating appliance).
- Allow a free flow of air around the TV.

Cleaning

- To avoid possible shock hazard, remove the TV's power cord from the electrical outlet before cleaning.
- Regularly dust the TV with a dry, non-scratching duster.
- When cleaning the TV, take care not to scratch or damage the screen surface. Avoid wearing jewelry or using anything abrasive. Do not use household cleaners. Wipe the screen with a clean cloth dampened with water. Use even, easy, vertical strokes when cleaning.
- Occasionally vacuum the vents on the rear of the TV.
- Never use thinners, insecticide sprays, or other chemicals on or near the cabinet. They may blemish the cabinet permanently.

**A**

Auto Program 7, 27

B

Balance 17, 24

Bass 17, 24

Batteries 3, 13, 27

Brightness 16, 18, 23

C

Care and Cleaning 28

Channel Setting 9

Color 16, 18, 23, 28

F

Factory Reset 10, 23

I

Index 29

L

Language 6

M

Mono 14, 17, 27

Manual Store 8

S

Sound 14, 17, 18, 24, 27

Sound Mode 14, 17, 27

Stereo 14, 17, 18, 27

T

Table of Contents 5

Teletext 22

Tint 16, 18

Treble 5, 17

Troubleshooting 27

TV Operation (Basic) 13

W

Welcome 2