

请至以下互联网址注册产品
以获得完整的信息服务

www.philips.com/welcome



产品外形根据型号不同会有所差异，
请以实际机型为准！



3700系列LED背光源液晶电视

32PHF3750/T3

50PFF3750/T3

55PFF3750/T3

快速 使用指南

PHILIPS

目录

包装清单	3
电池安装方式	4
安装底座	5
壁挂安装	6
连接	7



包装清单

您的产品包装箱内应该含有下列物品：

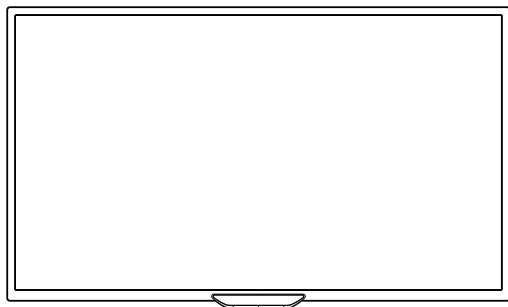

电视机

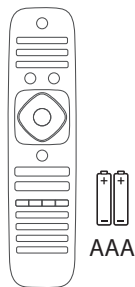

遥控器与2颗AAA电池

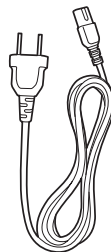

电源线

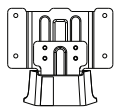

支架



螺丝

(32"/9颗, 50"/55":8颗)

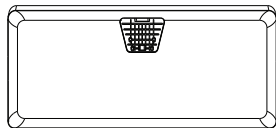

底座

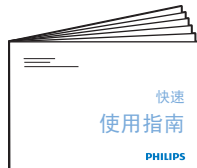

快速使用指南



使用手册

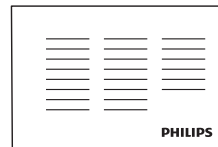

保修卡

1

电池安装方式

按下遥控器后方的电池盖后打开电池盖

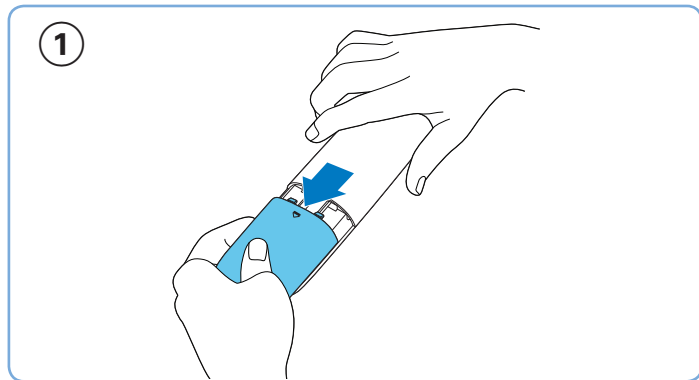

依图所示方向放入2颗AAA电池

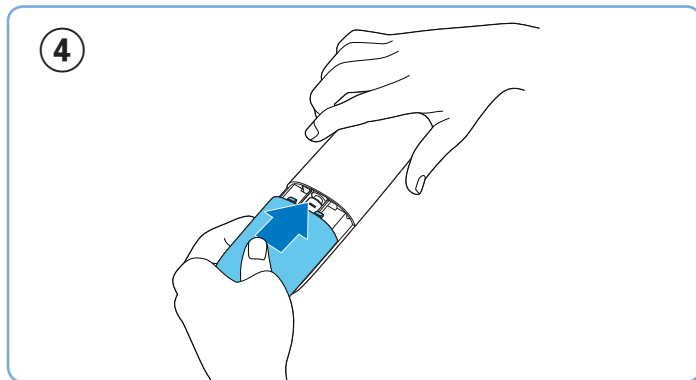
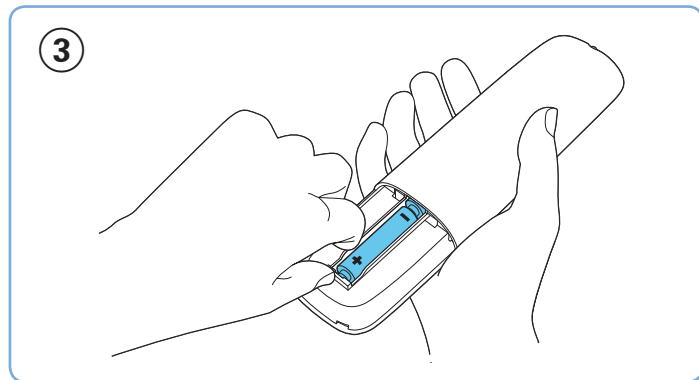
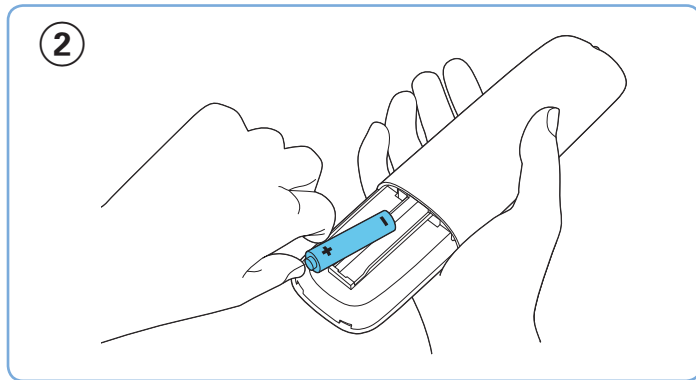

2



安装底座



步骤一：断开电视所有的线缆连接。
步骤二：将电视机正面朝下放在铺有软布的
稳定台面上，确定电视底部靠近台面边缘。
步骤三：从包装箱中取出底座并准备好螺丝
刀，按图示1方式将支架与底座结合，并锁
附螺丝(32" 锁5颗，50" /55" 锁4颗)。
步骤四：按图示2方式将底座插入电视机底
部固定槽中；按图示3方式将底座与电视机
锁紧，并锁附4颗螺丝。



再次确认各部件安装到位，螺丝全部锁紧
后，将机器抬起竖直放置到稳固的平整台面
上，再进行相关电缆连接及调试。因液晶面
板为易碎品，此安装过程注意尽量避免触
碰到液晶面板，以免造成液晶面板损伤。

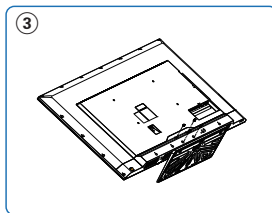
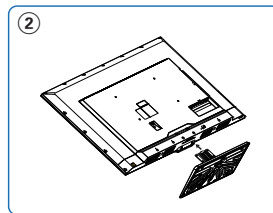
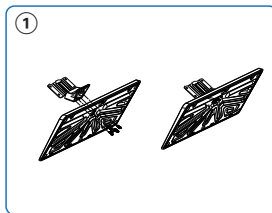

壁挂安装

电视机壁挂安装需要用到电视机壁挂架，壁挂架需要单独购买，本机未附带。

在安装电视之前，必须卸下电视的底座。

步骤一：用螺丝刀先将底座组件拆卸（卸下的螺丝、底座请保存好，以备日后电视要放桌面时使用。），若电视机尚未安装底座则略过此步骤；

步骤二：依照电视机壁挂架说明书或经由专业人士进行壁挂的安装。

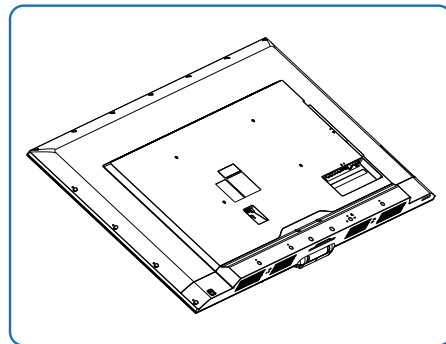

3

连接

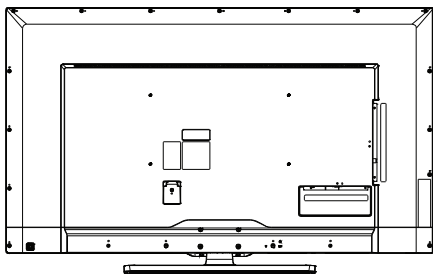

建议使用的影像端子接口:

<p>HDMI ★★★★★</p> 	<p>HDMI: 影像画质最佳</p>
<p>分量信号 & 左右声道 ★★★☆☆</p> 	<p>分量端子: 影像画质次佳</p>
<p>视频 & 左右声道 ★</p> 	<p>AV端子: 影像画质普通</p>

影音端子连接方式

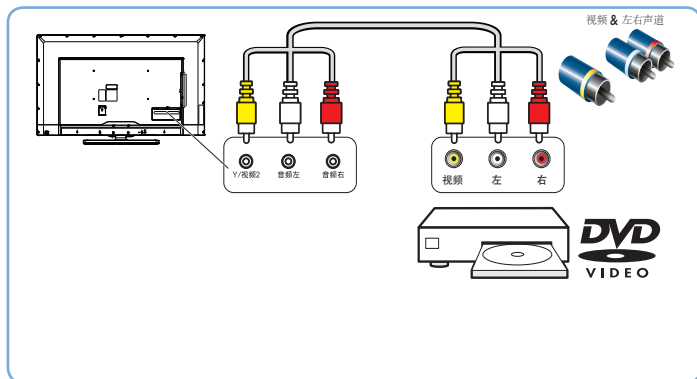
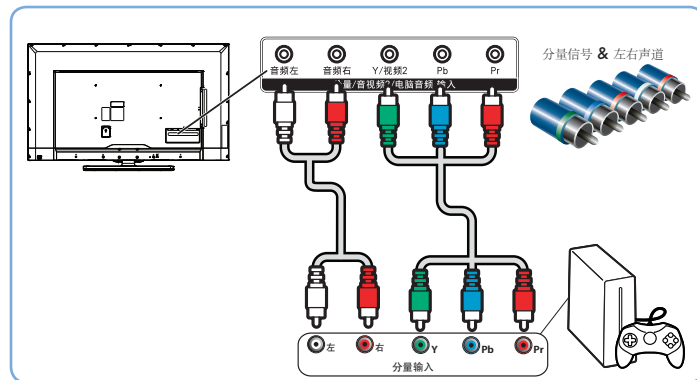
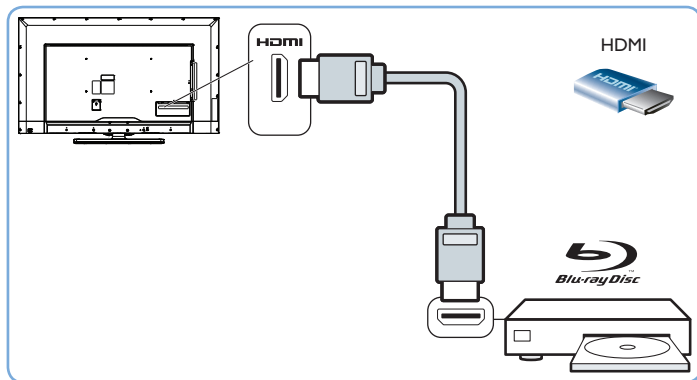

4

接上电源与电视信号 通过机顶盒连接

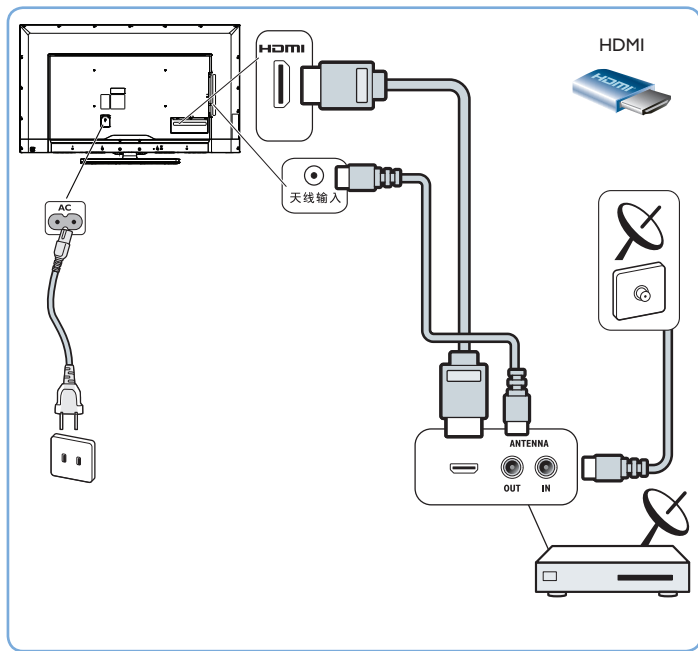

通过天线连接

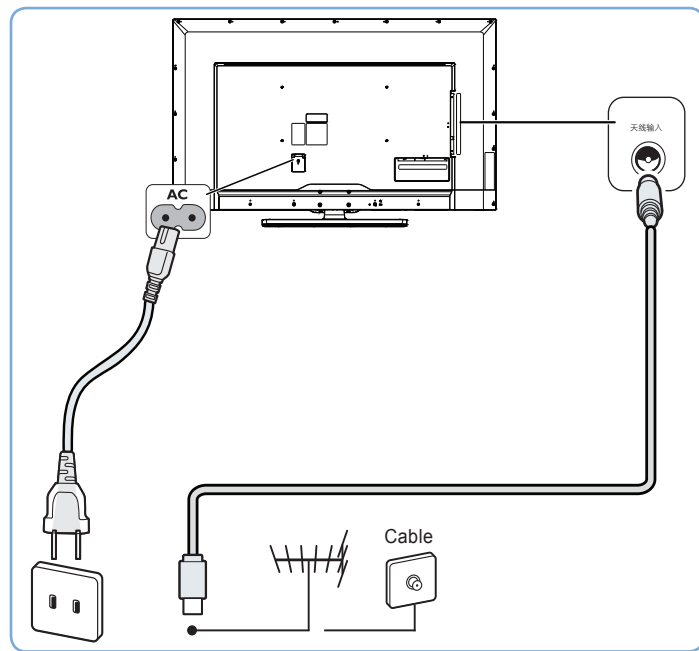

按下电视背面多功能方向键的中间键，
打开电视机

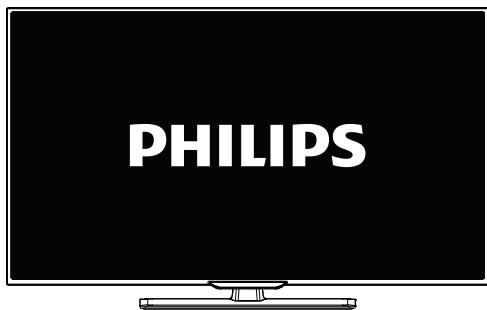
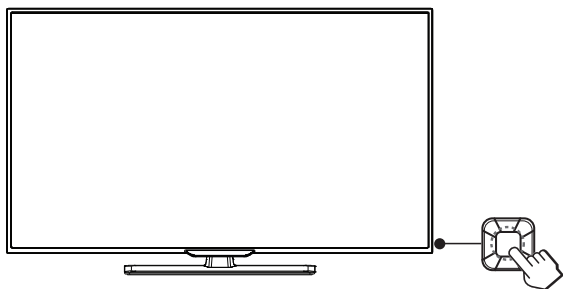



更多操作信息请参考使用手册与PHILIPS support网站。

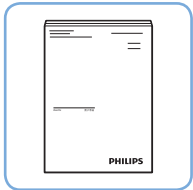

扫一扫，马上加入飞迷俱乐部！
享受专属延保、售后等服务，从这里开始！
www.philips.com.cn



所有注册和未注册的商标是其各自所有者的财产。
规格如有变更，恕不另行通知。

Philips 和 Philips 盾牌图形是皇家飞利浦有限公司的注册商标，
其使用需遵循皇家飞利浦有限公司的许可。

出版日期：2015年2月