

Register your product and get support at
www.philips.com/welcome

6402 series

Upute

32PFS6402

PHILIPS

Sadržaj

1 Što je novo?	4
1.1 Sveobuhvatni izbornik Izvori	4
1.2 Najpopularniji sadržaji	4
1.3 Preglednik multimedijjskih sadržaja	5
2 Postavljanje	6
2.1 Pročitajte sigurnosne upute	6
2.2 Postolje televizora i montaža na zid	6
2.3 Savjeti za postavljanje	6
2.4 Kabel za napajanje	6
2.5 Antenski kabel	7
2.6 Satelitska antena	7
3 Daljinski upravljač	8
3.1 Pregled tipki	8
3.2 Glasovno pretraživanje	9
3.3 Infracrveni senzor	10
3.4 Baterije	10
3.5 Čišćenje	10
4 Uključivanje/isključivanje	11
4.1 Uključivanje ili stanje pripravnosti	11
4.2 Tipke na televizoru	11
5 Kanali	12
5.1 Instalacija satelita	12
5.2 Instalacija antenskih/kabelskih	14
5.3 Kopiranje popisa kanala	16
5.4 O kanalima	17
6 Povezivanje uređaja	24
6.1 O povezivanju	24
6.2 HDMI priključnice	24
6.3 Y Pb Pr – komponentni	25
6.4 Scart	25
6.5 Audio izlaz – optički	26
6.6 CAM s pametnom karticom – CI+	26
6.7 Sustav kućnog kina – HTS	27
6.8 Pametni telefoni i tableti	27
6.9 Blu-ray Disc reproduktor	28
6.10 DVD reproduktor	28
6.11 Bluetooth – zvučnici i upravljači	28
6.12 Slušalice	29
6.13 Igrača konzola	29
6.14 Upravljač za igranje	30
6.15 USB tvrdi disk	30
6.16 USB tipkovnica	31
6.17 USB Flash pogon	32
6.18 Fotoaparati	32
6.19 Kamkorder	32
6.20 Računalo	32
7 Povezivanje Android TV-a	34
7.1 Mreža i internet	34
7.2 Google račun	36
7.3 Galerija aplikacija tvrtke Philips	37
7.4 Postavke za Android	38
7.5 Izbornik Početak	38
8 Aplikacije	40
8.1 Više o aplikacijama	40
8.2 Google Play	40
8.3 Pokretanje ili zaustavljanje aplikacije	41
8.4 Blokada aplikacija	41
8.5 Upravljanje aplikacijama	43
8.6 Spremanje	43
9 Internet	44
9.1 Pokretanje interneta	44
9.2 Opcije na internetu	44
10 Izbornik televizora	45
10.1 O izborniku televizora	45
10.2 Otvaranje izbornika televizora	45
11 Izvori	46
11.1 Prelazak na uređaj	46
11.2 Opcije TV ulaza	46
11.3 Naziv i vrsta uređaja	46
11.4 Računalo	46
12 Postavke	48
12.1 Česte postavke	48
12.2 Slika	48
12.3 Zvuk	52
12.4 Postavke funkcije Ambilight	54
12.5 Ekološke postavke	57
12.6 Općenite postavke	57
12.7 Sat, regija i jezik	59
12.8 Univerzalni pristup	62
12.9 Blokada uređaja	63
13 Videozapisi, fotografije i glazba	65
13.1 S povezanog USB uređaja	65
13.2 S računala ili NAS uređaja	65
13.3 S usluge pohrane u oblaku	65
13.4 Izbornici Omiljeni, Najpopularnije, Posljednje reproducirano	65
13.5 Reprodukcijski vaših videozapisa	66
13.6 Gledanje vaših fotografija	66
13.7 Reprodukcijski glazbe	66
14 TV vodič	68
14.1 Što je potrebno	68
14.2 Podaci TV vodiča	68
14.3 Uporaba TV vodiča	68
15 Snimanje i Pause TV	70
15.1 Snimanje	70
15.2 Pause TV	71
16 Pametni telefoni i tableti	72
16.1 Philips TV Remote App	72
16.2 Google Cast	72
16.3 AirPlay	72
16.4 MHL	72
17 Igre	73
17.1 Što je potrebno	73
17.2 Igranje igre	73
18 Ambilight	74
18.1 Ambilight stil	74
18.2 Isključivanje funkcije Ambilight	74
18.3 Postavke funkcije Ambilight	74
19 Najpopularniji sadržaji	76
19.1 O najpopularnijim sadržajima	76
19.2 Sada na TV-u	76
19.3 TV na zahtjev	76
19.4 Video na zahtjev	76
20 Netflix	78
21 Multi View	79

21.1	Teletekst i TV	79
21.2	HDMI i televizor	79
21.3	Nettv i televizija	79
21.4	Nettv i HDMI	79
22	Softver	80
22.1	Ažuriraj softver	80
22.2	Verzija softvera	80
22.3	Softver otvorenog koda	80
22.4	Licenca za otvoreni kod	81
22.5	Obavijesti	200
23	Specifikacije	201
23.1	Zaštita okoliša	201
23.2	Snaga	201
23.3	Operativni sustav	202
23.4	Prijem	202
23.5	Vrsta zaslona	202
23.6	Rezolucija zaslona	202
23.7	Dimenzije i mase	202
23.8	Mogućnost povezivanja	202
23.9	Zvuk	203
23.10	Multimedija	203
24	Pomoć i podrška	204
24.1	Registracija televizora	204
24.2	Korištenje pomoći	204
24.3	Rješavanje problema	204
24.4	Pomoć na mreži	206
24.5	Podrška i popravak	206
25	Sigurnost i održavanje	208
25.1	Sigurnost	208
25.2	Briga za zaslon	209
26	Odredbe uporabe	210
26.1	Odredbe uporabe – televizor	210
26.2	Odredbe uporabe – Galerija aplikacija	210
27	Autorska prava	211
27.1	MHL	211
27.2	HDMI	211
27.3	Dolby Audio	211
27.4	DTS 2.0+Digital Out™	211
27.5	Microsoft	211
27.6	Wi-Fi Alliance	211
27.7	Kensington	211
27.8	Drugi zaštitni znakovi	212
28	Izjava o odricanju od odgovornosti za usluge i/ili softver trećih strana	213
Indeks		214

1

Što je novo?

1.1





Sveobuhvatni izbornik Izvori

Više o sveobuhvatnom izborniku Izvori

Kada prvi put pritisnete  SOURCES, prikazat će se upute za postavljanje izbornika Izvori.

Unaprijedni izbornik Izvori sadrži normalni izbornik Izvori; jednostavno otvorite TV vodič i odaberite **+** (tipka plus) kako biste postavili podsjetnik ili zakazali snimanje u TV vodiču.

Sveobuhvatni izbornik Izvori, stilizirani TV vodič i novi jednostavni preglednik programa.

Vaš popis omiljenih kanala  sada je dio izbornika Izvori . Isto vrijedi za popise kanala oba tunera;  Antenski/kabelski i  Satelitski.

Novi izbornik Izvori na popisu će prikazivati sve povezane uređaje, ali i sve tunere, tako da će korisnik u izborniku Izvori može pronaći sve moguće "izvore" za televizor.

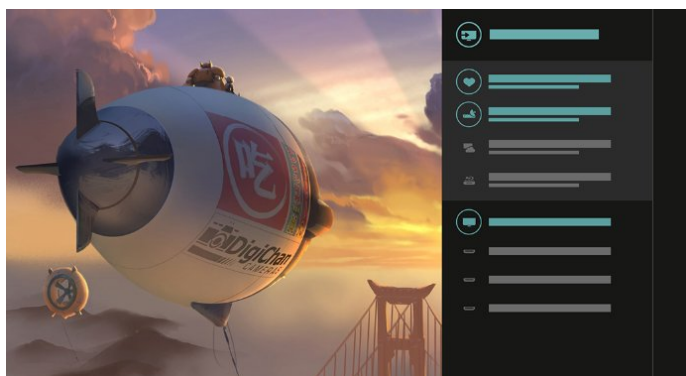

Odabir tunera, kanala ili TV vodiča

Odaberite izvor tunera i pritisnite **>** kako biste otvorili popis kanala. Ponovo pritisnite **>** kako biste otvorili  TV vodič i vidjeli raspored programa. Pritisnite **<** za povratak na popis kanala.

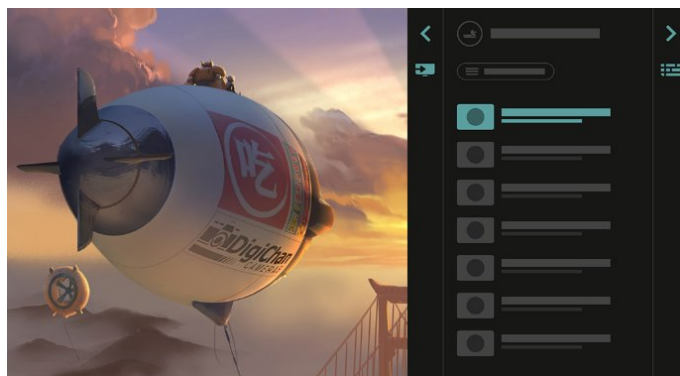

Poboljšani TV vodič

Jasniji i pregledniji TV vodič. Odaberite program i pročitajte opis ili pritisnite **+** za odabir podsjetnika ili zakazivanje snimanja.

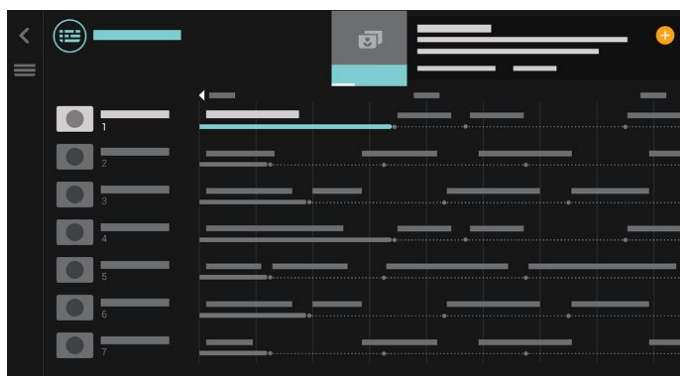

1.2

Najpopularniji sadržaji

Uz opciju  TOP PICKS televizor preporučuje trenutne televizijske programe, najnovije videozapise za posuđivanje i televizijske usluge na mreži koje možete gledati.

1 - Pritisnite  TOP PICKS.

2 - Odaberite program i pritisnite **+** (tipka plus) kako biste zakazali snimanje, postavili podsjetnik ili gledali program.

3 - Pomoću tipki sa strelicama / navigacijskih tipki odaberite 3 točke u gornjem desnom kutu zaslona i zatim pritisnite OK za otvaranje izbornika **OPTIONS**.

Odaberite  za snimanje ili odaberite  za postavljanje izbornika



Odaberite  za označavanje favorita



4 - Prilikom reprodukcije na dnu zaslona se prikazuje pomoćna kontrolna traka; strelicama odaberite željenu stavku i potvrdite odabir tipkom OK.

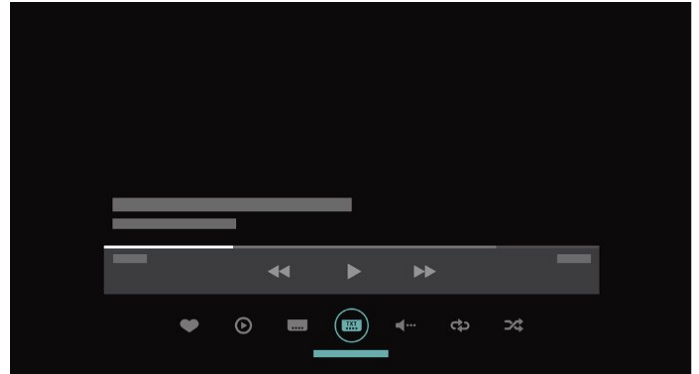

1.3

Preglednik multimedijjskih sadržaja

Možete jednostavno pretraživati svoje multimedijjske sadržaje ili označiti bilo koji kanal, pjesmu ili fotografiju kao omiljene.

1 - Pritisnite **+** (tipka plus) kako biste bilo koji videozapis, pjesmu ili fotografiju označili kao omiljene.

2 - Videozapise, pjesme i fotografije možete pregledavati u obliku mreže ili popisa.

3 - Pomoću tipki sa strelicama / navigacijskih tipki odaberite 3 točke u gornjem desnom kutu zaslona i zatim pritisnite OK za otvaranje izbornika **OPTIONS**.

Mrežni prikaz

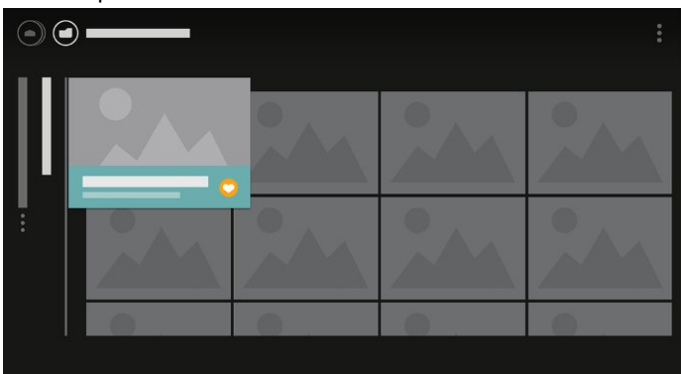

Prikaz popisa

Postavljanje

2.1

Pročitajte sigurnosne upute

Prije uporabe televizora pročitajte sigurnosne upute.

Kako biste pronašli više informacija, u izborniku **Pomoć** odaberite **Ključne riječi** i potražite **Sigurnosne upute**.

2.2

Postolje televizora i montaža na zid

Postolje televizora

Upute za montažu postolja televizora pronaći ćete u **Kratkim uputama** priloženima uz televizor. Ako ste slučajno izgubili te upute, možete ih preuzeti na web-mjestu www.philips.com.

Pomoću broja modela televizora pronađite **Kratke upute** koje ćete preuzeti.

Montaža na zid

Vaš se televizor može montirati pomoću zidnog nosača sukladnog VESA standardu (prodaje se zasebno).

Prilikom kupnje zidnog nosača upotrijebite sljedeći VESA kôd . . .

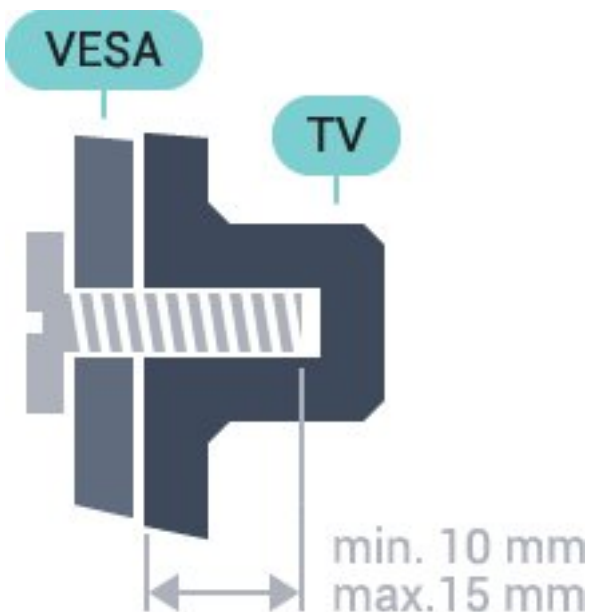

- 32PFS6402
- VESA MIS-F 100x100, M4
- 43PUS6432, 43PUS6452

VESA MIS-F 200 x 200, M6

- 49PUS6432, 49PUS6452

VESA MIS-F 400x200, M6

- 55PUS6432, 55PUS6452

VESA MIS-F 400x200, M6

Priprema

Najprije izvadite 4 plastična pokrova za vijke iz rupa s navojem na stražnjoj strani televizora.

Pazite da metalni vijci, kojima ćete televizor montirati na nosač sukladan standardu VESA, ulaze približno 10 mm u rupe s navojem na televizoru.

Oprez

Montaža televizora na zid zahtijeva posebne vještine i trebale bi ga izvoditi kvalificirane osobe. Montaža televizora na zid treba se provesti u skladu sa sigurnosnim standardima vezanima uz težinu televizora. Prije postavljanja televizora pročitajte i sigurnosne mjere.

TP Vision Europe B.V. ne snosi odgovornost za nepravilnu montažu niti bilo kakvu montažu koja može dovesti do nezgode ili ozljede.

2.3

Savjeti za postavljanje

- Televizor postavite na mjesto gdje svjetlost ne pada izravno na zaslom.
- Televizor smjestite do 15 cm od zida.
- Idealna udaljenost za gledanje televizije jednaka je veličini dijagonale zaslona uvećanoj tri puta. Kada ste u sjedećem položaju, oči trebaju biti u ravnini sa sredinom zaslona.

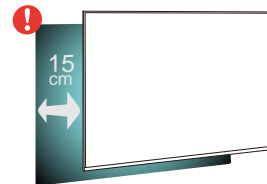

2.4

Kabel za napajanje

- Kabel za napajanje ukopčajte u priključnicu za napajanje **POWER** na stražnjoj strani televizora.
- Kabel za napajanje mora biti čvrsto ukopčan u priključnicu.
- Pazite da utikač u zidnoj električnoj utičnici uvijek bude dostupan.
- Prilikom iskopčavanja kabela za napajanje uvijek vucite za utikač, nikada za kabel.



Iako je potrošnja energije ovog televizora kada je u stanju pripravnosti vrlo mala, kako biste uštedjeli energiju, iskopčajte kabel za napajanje ako televizor nećete koristiti duže vrijeme.

2.5

Antenski kabel

Priključak za antenu čvrsto umetnite u priključnicu **Antenna** na stražnjoj strani televizora.

Možete povezati svoju antenu ili antenske signale iz distribucijskog sustava. Koristite koaksijalni antenski kabel s IEC RF priključkom, 75 ohma.

Antenski priključak koristite za DVB-T i DVB-C ulazne signale.

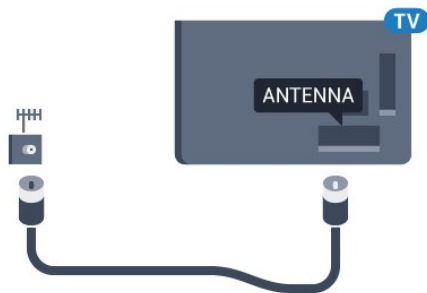

2.6

Satelitska antena

Satelitski priključak F umetnite u satelitsku priključnicu **SAT** na stražnjoj strani televizora.

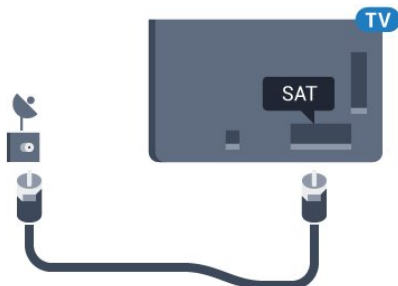

Daljinski upravljač

Pregled tipki

Gornje

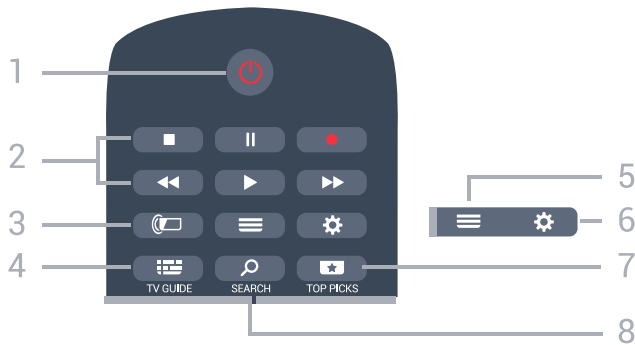

1 – stanje pripravnosti / uključivanje
Uključivanje televizora ili vraćanje u stanje pripravnosti.

2 – **reprodukcija i snimanje**
 · Reprodukcija , za reprodukciju.
 · Pauza , za pauziranje reprodukcije
 · Zaustavljanje , za zaustavljanje reprodukcije
 · Premotavanje , za premotavanje unatrag
 · Brzo premotavanje unaprijed , za brzo premotavanje unaprijed
 · Snimanje , za pokretanje snimanja

3 – **Ambilight**
Odabir jednog od Ambilight stilova.

4 – **TV GUIDE**
Otvaranje ili zatvaranje televizijskog vodiča.

5 – **LIST**
Otvaranje ili zatvaranje popisa kanala.

6 – **postavke**
Otvorite Česte postavke.

7 – **TOP PICKS**
Za otvaranje izbornika s preporučenim programima, odaberite Video na zahtjev (Posudba videozapisa) ili Online TV (Catch Up TV).
Ako je dostupno.

8 – **SEARCH**
Otvaranje stranice pretraživanja.

Srednje

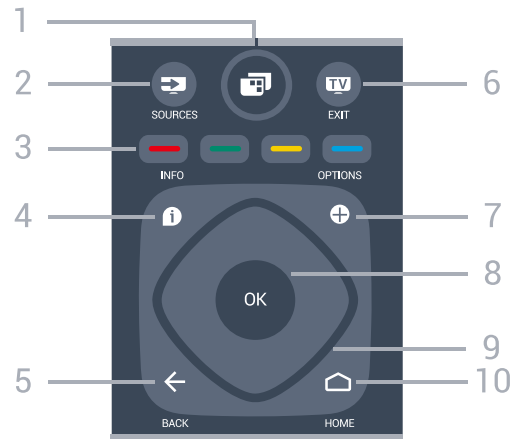

1 – **Izbornik televizora**

Za otvaranje izbornika televizora s tipičnim funkcijama televizora.

2 – **SOURCES**
Otvaranje izbornika Izvori.

3 – Tipke u boji
Izravan odabir opcija.

4 – **INFO**
Otvaranje ili zatvaranje informacija o programu.

5 – **BACK**
Kako biste se vratili na prethodni kanal koji ste odabrali.
Za povratak na prethodni izbornik.
Povratak na prethodnu aplikaciju / internetsku stranicu.

6 – **EXIT**
Povratak na gledanje televizije. Za zaustavljanje interaktivne televizijske aplikacije.

7 – **OPTIONS**
Otvaranje ili zatvaranje izbornika Opcije.

8 – tipka **OK**
Potvrda odabira ili postavke. Za otvaranje popisa kanala dok gledate televizor.

9 – tipke sa strelicama / navigacijske tipke
Navigacije prema gore, dolje, ulijevo ili udesno.

10 – **HOME**
Otvaranje izbornika Početak.

Donje tipke



1 – NETFLIX

Za izravno otvaranje aplikacije Netflix. Kad je televizor uključen ili u stanju pripravnosti.

2 – glasnoća

Podešavanje razine glasnoće.

3 – numeričke tipke

Izravan odabir kanala.

4 – SUBTITLE

Za uključivanje, isključivanje ili automatsko prikazivanje titlova.

5 – kanal

Prelazak na sljedeći ili prethodni kanal na popisu kanala. Otvaranje sljedeće ili prethodne stranice teleteksta. Pokretanje sljedećeg ili prethodnog poglavlja na disku.

6 – isključivanje zvuka

Isključivanje zvuka i njegovo ponovno uključivanje.

7 – TEXT

Otvaranje ili zatvaranje teleteksta.

3.2

Glasovno pretraživanje

Preuzimanje aplikacije s usluge Google Play.

Koristite svoj Android pametni telefon ili tablet kao daljinski upravljač za Android televizor. Jednostavno mijenjajte odabir između usmjerenog upravljača, dodirne ploče i upravljača za igranje za pretraživanje sadržaja i igranje igara na vašem Android televizoru. Dodirnite mikrofonsku ikonu za početak glasovnog pretraživanja ili upotrijebite tipkovnicu za unos teksta na Android televizoru.

Za početak povežite Android telefon ili tablet na istu mrežu na kojoj se nalazi Android televizor ili pronađite Android televizor Bluetooth vezom.

To vrijedi za sve Android televizore.

*Za korištenje aplikacije TV Remote Control potreban vam je Android telefon ili tablet sa sustavom Android 4.3 ili novijom verzijom.

Uparivanje s televizorom

Na vašem daljinskom upravljaču nema mikrofona pa je za glasovno pretraživanje prvo potrebno instalirati aplikaciju **Android TV Remote Control** na vaš Android telefon ili tablet.

1 - Na Android telefonu ili tabletu potražite "Android TV Remote Control" u trgovini Google Play.

2 - Preuzmite i instalirajte aplikaciju **Android TV Remote Control*** na svom Android pametnom telefonu ili tabletu.

3 - Povežite Android pametni telefon ili tablet na istu mrežu na kojoj se nalazi Android televizor.

4 - Odaberite "PhilipsTv"*** na Android pametnom telefonu ili tabletu i na zaslonu Android televizora prikazat će se kôd.

5 - Unesite taj kôd na Android pametni telefon ili tablet kako biste ga uparili s Android televizorom.

*Za korištenje aplikacije TV Remote Control potreban vam je Android telefon ili tablet sa sustavom Android 4.3 ili novijom verzijom.

**Naziv vašeg Android televizora ovisi o tome koji ste naziv postavili kao Mrežni naziv televizora. Unaprijed zadani naziv je naziv modela televizora.

Upotreba glasovnog pretraživanja

Možete pretraživati videozapise, glazbu ili bilo što drugo na internetu pomoću ikone na vrhu izbornika Početak. Glasovno pretraživanje možete pokrenuti u bilo kojem trenutku. Umjesto toga možete i unijeti tekst pomoću tipkovnice daljinskog upravljača.

Za korištenje glasovnog pretraživanja...

1 - Za pokretanje glasovnog pretraživanja dodirnite ikonu na pametnom telefonu.

2 - Ikona je crvena na zaslonu, mikrofonski je aktivan.

3 - Jasno izgovorite što tražite. Možda će biti potrebno neko vrijeme da se rezultati prikažu.

4 - Možete odabrati željenu stavku na zaslonu s rezultatima pretraživanja.

Pogledajte i www.support.google.com/androidtv

Postavke glasovnog pretraživanja

Možete postaviti jezik koji želite koristiti za glasovno pretraživanje.

Za postavljanje jezika za glasovno pretraživanje...

- 1 - Pritisnite , odaberite **Sve postavke** i pritisnite **OK**.
- 2 - Odaberite **Postavke za Android** i pritisnite **OK**.
- 3 - Odaberite **Preference > Govor** i pritisnite **OK**.
- 4 - Odaberite željeni jezik i pritisnite **OK**.
- 5 - Pritisnite **← BACK** za vraćanje jedan korak ili pritisnite **EXIT** za zatvaranje izbornika.

3.3

Infracrveni senzor

Televizor može primiti naredbe i s daljinskog upravljača koji koristi IR (infracrvenu vezu) za slanje naredbi. Ako koristite takav daljinski upravljač, uvijek usmjerite daljinski upravljač prema infracrvenom senzoru na prednjoj strani televizora.

Upozorenje

Ne postavljajte predmete ispred IC senzora televizora; mogli bi blokirati IC signal.

3.4

Baterije

Ako televizor ne reagira na pritisak tipke na daljinskom upravljaču, možda su baterije prazne.

Za zamjenu baterija otvorite odjeljak za baterije na stražnjoj strani daljinskog upravljača.

- 1 - Gurnite poklopac odjeljka za baterije u smjeru koji naznačuje strelica.
- 2 - Stare baterije zamijenite s 2 nove baterije **AAA-R03 – 1,5 V**. Pazite da polovi + i - na baterijama budu ispravno poravnati.
- 3 - Vratite poklopac odjeljka za baterije i gurajte ga dok ne sjedne na mjesto.

Ako daljinski upravljač ne koristite duže vrijeme, izvadite baterije.

Stare baterije sigurno odložite u skladu s propisima o odlaganju starih baterija.

Kako biste pronašli više informacija, u izborniku **Pomoć** odaberite **Ključne riječi** i potražite **Kraj uporabe**.

3.5

Čišćenje

Vaš daljinski upravljač ima premaz otporan na ogrebotine.



Daljinski upravljač čistite mekom, vlažnom krpom. Daljinski upravljač nikada nemojte čistiti tvarima kao što su alkohol, kemikalije ili sredstva za čišćenje u kućanstvu.

Uključivanje/isključivanje

Uključivanje ili stanje pripravnosti

Provjerite je li televizor priključen na mrežno napajanje. Priključite priloženi kabel za napajanje u AC in priključak na stražnjoj strani televizora. Počet će svijetliti indikator na donjem dijelu televizora.

Uključivanje

Pritisnite  na daljinskom upravljaču kako biste uključili televizor. Umjesto toga, pritisnite  HOME . Možete i pritisnuti malu joystick tipku na stražnjoj strani televizora kako biste uključili televizor u slučaju da ne možete pronaći daljinski upravljač ili da su njegove baterije prazne.

Prebacivanje u stanje pripravnosti

Kako biste televizor prebacili u stanje pripravnosti, pritisnite  na daljinskom upravljaču. Možete i pritisnuti malu joystick tipku na stražnjoj strani televizora.



U stanju pripravnosti, televizor je i dalje priključen na mrežno napajanje, ali troši vrlo malo energije.

Kako biste televizor potpuno isključili, iskopčajte utikač.



Prilikom iskopčavanja utikača uvijek vucite utikač, a ne kabel. Osigurajte potpun pristup utikaču, kabelu za napajanje i utičnici u svakom trenutku.

Tipke na televizoru

Ako ste izgubili daljinski upravljač ili su njegove baterije prazne, još uvijek možete izvršiti neke osnovne radnje.

Otvaranje izbornika s osnovnim radnjama...

1 - Dok je televizor uključen, pritisnite joystick tipku na stražnjoj strani televizora kako bi se prikazao osnovni izbornik.

2 - Pritisnite lijevo ili desno kako biste odabrali  Glasnoća,  Kanali ili  Izvori.

Odaberite  Demo kako biste pokrenuli film za demonstraciju.

3 - Pritisnite gore ili dolje kako biste prilagodili glasnoću ili prešli na sljedeći/prethodni kanal. Pritisnite gore ili dolje kako biste se pomicali popisom izvora, što obuhvaća i odabir tunera. Pritisnite višesmjernu tipku kako biste pokrenuli film za demonstraciju.

4 - Izbornik će automatski nestati.

Kako biste televizor prebacili u stanje pripravnosti, odaberite  i pritisnite joystick tipku.



Kanali

5.1

Instalacija satelita

O instalaciji satelita

Do 4 satelita

Na ovaj televizor možete instalirati do 4 satelita (4 LNB uređaja). Na početku instalacije odaberite točan broj satelita koje želite instalirati. To će ubrzati instalaciju.

Unicable

Sustav Unicable možete koristiti za povezivanje satelitske antene s televizorom. Na početku instalacije možete odabrati Unicable za 1 ili 2 satelita.

Početak instalacije

Provjerite je li satelitska antena ispravno povezana i savršeno smještena prije početka instalacije.

Početak instalacije satelitskih kanala...

- 1 - Pritisnite , odaberite **Sve postavke** i pritisnite **OK**.
- 2 - Odaberite **Kanali > Instalacija satelita**. Unesite PIN kod ako je potrebno.
- 3 - Odaberite **Traži satelitske kanale**.
- 4 - Odaberite **Traži**. Televizor će tražiti satelite.
- 5 - Odaberite **Instaliraj**. Televizor prikazuje trenutnu instalaciju.
Ako želite promijeniti tu postavku, odaberite **Postavke**.
Ako ne želite promijeniti postavku, odaberite **Traži**.
Idite na korak 5.
- 6 - U opciji **Sustav za instalaciju** odaberite broj satelita koje želite instalirati ili odaberite jedan od Unicable sustava. Kada odaberete Unicable, možete odabrati Brojeve korisničkog pojasa i unijeti Frekvencije korisničkog pojasa za svaki tuner. U nekim državama možete prilagođavati određene profesionalne postavke za svaki LNB u opciji **Dodatne postavke**.
- 7 - Televizor će tražiti satelite koji su dostupni sukladno poravnanju satelitske antene. To može potrajati nekoliko minuta. Ako se pronađe satelit, njegov naziv i jačina signala prikazuju se na zaslonu.
- 8 - Kada televizor pronađe željene satelite, odaberite **Instaliraj**.
- 9 - Ako satelit pruža **pakete kanala**, televizor će prikazati dostupne pakete za taj satelit. Odaberite paket koji vam je potreban.
- 10 - Kako biste spremili satelitsku konfiguraciju te

instalirane kanale i radijske stanice, odaberite **Gotovo**.

Postavke instalacije satelita

Postavke instalacije satelita zadane su s obzirom na vašu državu. Te postavke određuju kako televizor traži i instalira satelite i njihove kanale. Te postavke uvijek možete promijeniti.

Za promjenu postavki instalacije satelita...

- 1 - Pokrenite instalaciju satelita.
- 2 - Na zaslonu na kojem počinjete tražiti satelite odaberite **Postavke** i pritisnite **OK**.
- 3 - Odaberite broj satelita koje želite instalirati ili odaberite jedan od Unicable sustava. Kada odaberete Unicable, možete odabrati Brojeve korisničkog pojasa i unijeti Frekvencije korisničkog pojasa za svaki tuner.
- 4 - Kad završite, odaberite **Sljedeće** i pritisnite **OK**.
- 5 - U izborniku **Postavke** pritisnite **OK** kako biste se vratili na zaslon za traženje satelita.

Primopredajnik za navođenje i LNB

U nekim državama možete prilagođavati određene profesionalne postavke za primopredajnik za navođenje i svaki LNB. Te postavke koristite ili promijenite jedino ako normalna instalacija ne uspije. Ako imate nestandardnu satelitsku opremu, možete upotrijebiti ove postavke za poništavanje standardnih postavki. Neki pružatelji usluga mogu vam dati vrijednosti za primopredajnik ili LNB koje ovdje možete unijeti.

CAM moduli za satelitske kanale

Ako koristite CAM (modul uvjetnog pristupa s pametnom karticom) za gledanje satelitskih kanala, preporučujemo vam da instalaciju satelitskih kanala izvršite dok je CAM modul umetnut u televizor.

Većina CAM modula koristi se za dekodiranje kanala.

CAM moduli najnovije generacije (CI+ 1.3 s profilom operatera) mogu samostalno instalirati sve satelitske kanale na televizoru. CAM će vam ponuditi da instalirate satelite i kanale. Ovi CAM moduli ne samo da instaliraju i dekodiraju kanale, nego i izvršavaju redovito ažuriranje kanala.

Paketi kanala

Davatelji satelitskih sadržaja mogu nuditi pakete kanala koji sadrže besplatne kanale (free-to-air) i izbor koji odgovara državi. Neki sateliti nude pakete pretplate – kolekciju kanala koje plaćate.

Unicable postavke

Sustav Unicable

Sustav s jednim kabelom, MDU ili Unicable, možete koristiti za povezivanje satelitske antene s televizorom. Sustav s jednim kabelom koristi jedan kabel za povezivanje satelitske antene sa svim satelitskim tunerima u sustavu. Sustav s jednim kabelom obično se koristi u stambenim zgradama. Ako koristite sustav Unicable, televizor će tijekom instalacije zatražiti da dodijelite broj korisničkog pojasa i odgovarajuću frekvenciju. Na ovom televizoru možete instalirati 1 ili 2 satelita koristeći Unicable.

Ako primijetite da u Unicable instalaciji nedostaju neki kanali, možda je na sustavu Unicable u isto vrijeme izvršena druga instalacija. Ponovite instalaciju kako biste instalirali kanale koji nedostaju.

Broj korisničkog pojasa

U sustavu Unicable svaki povezani satelitski tuner mora biti označen brojem (npr. 0, 1, 2 ili 3 itd.).

Dostupne korisničke pojase i njihove brojeve možete pronaći na Unicable modulu. Korisnički pojas može biti označen kao UB. Postoje Unicable moduli koje nude 4 ili 8 korisničkih pojasa. Ako u postavkama odaberete Unicable, televizor će zatražiti dodjelu jedinstvenog broja korisničkog pojasa za ugrađeni satelitski tuner. Satelitski tuner ne može imati isti broj korisničkog pojasa kao neki drugi satelitski tuner u sustavu Unicable.

Frekvencija korisničkog pojasa

Osim jedinstvenog broja korisničkog pojasa, ugrađeni satelitski prijemnik treba frekvenciju odabranog broja korisničkog pojasa. Te frekvencije uglavnom se nalaze pokraj broja korisničkog pojasa na Unicable modulu.

Ručno ažuriranje kanala

Ažuriranje kanala uvijek možete sami pokrenuti.

Ručno pokretanje ažuriranja kanala...

- 1 - Pritisnite , odaberite **Sve postavke** i pritisnite **OK**.
- 2 - Odaberite **Kanali > Instalacija satelita**.
- 3 - Odaberite **Traži kanale**.
- 4 - Odaberite **Ažuriraj kanale**. Televizor će se početi ažurirati. Ažuriranje može potrajati nekoliko minuta.
- 5 - Slijedite upute na zaslonu. Ažuriranje može potrajati nekoliko minuta.
- 6 - Odaberite **Dovrši** i pritisnite **OK**.

Dodavanje satelita

Možete dodati još jedan satelit postojećoj satelitskoj instalaciji. Instalirani sateliti i njihovi kanali ostaju nepromijenjeni. Međutim, neki satelitski operateri ne dopuštaju dodavanje satelita.

Dodatni satelit trebao bi se prikazivati kao dodatni jer on nije vaš glavni satelit niti je glavni satelit čiji paket kanala upotrebljavate. Obično se dodaje 4. satelit ako su 3 satelita već instalirana. Ako imate 4 satelita instalirana, najprije morate jedan ukloniti kako biste mogli dodati novi.

Podešavanje

Ako trenutno imate samo 1 ili 2 instalirana satelita, trenutne postavke instalacije možda ne dopuštaju dodavanje još jednog satelita. Ako trebate promijeniti postavke instalacije, morate ponoviti cijelu instalaciju satelita. Ako trebate promijeniti postavke, ne možete upotrijebiti opciju **Dodaj satelit**.

Dodavanje satelita...

- 1 - Pritisnite , odaberite **Sve postavke** i pritisnite **OK**.
- 2 - Odaberite **Kanali > Instalacija satelita**.
- 3 - Odaberite **Traži satelitske kanale**.
- 4 - Odaberite **Dodaj satelit**. Prikazat će se trenutni sateliti.
- 5 - Odaberite **Traži**. Televizor će tražiti nove satelite.
- 6 - Ako je televizor pronašao jedan ili više satelita, odaberite **Instaliraj**. Televizor će instalirati kanale pronađenih satelita.
- 7 - Odaberite **Dovrši** i pritisnite **OK** kako biste spremili kanale i radijske stanice.

Uklanjanje satelita

Možete ukloniti jedan ili više satelita iz trenutne instalacije satelita. Sa satelitom se uklanjaju i njegovi kanali. Međutim, neki satelitski operateri ne dopuštaju uklanjanje satelita.

Uklanjanje satelita...

- 1 - Pritisnite , odaberite **Sve postavke** i pritisnite **OK**.
- 2 - Odaberite **Kanali > Instalacija satelita**.
- 3 - Odaberite **Traži satelitske kanale**.
- 4 - Odaberite **Ukloni satelit**. Prikazat će se trenutni sateliti.
- 5 - Odaberite satelit i pritisnite **OK** kako biste ga označili ili odznačili za uklanjanje.
- 6 - Po potrebi više puta pritisnite **<** (lijevo) kako biste zatvorili izbornik.





Ručna instalacija

Ručna instalacija namijenjena je naprednim korisnicima.

Opciju Ručna instalacija možete upotrijebiti za brzo dodavanje novih kanala sa satelitskog primopredajnika. Trebate znati frekvenciju i polarizaciju primopredajnika. Televizor će instalirati sve kanale tog primopredajnika. Ako je primopredajnik prije instaliran, svi njegovi kanali – stariji i novi – premještaju se na kraj popisa kanala Sve.

Opciju Ručna instalacija ne možete upotrebljavati ako trebate promijeniti broj satelita. Ako trebate promijeniti broj satelita, morate izvršiti potpunu instalaciju pomoću opcije Instaliraj satelite.

Instalacija primopredajnika...

- 1 - Pritisnite , odaberite Sve postavke i pritisnite OK.
- 2 - Odaberite Kanali > Instalacija satelita.
- 3 - Odaberite Ručna instalacija i pritisnite  (desno) kako biste otvorili izbornik.
- 4 - Ako imate instalirano više satelita, odaberite LNB kojemu želite dodati kanale.
- 5 - Postavite odgovarajuću opciju Polarizacija. Ako postavite Način rada za protok podataka na Ručno, možete ručno unijeti protok podataka u opciji Protok podataka.
- 6 - Pritisnite strelice  (gore) ili  (dolje) kako biste prilagodili frekvenciju i odaberite Gotovo.
- 7 - Odaberite Traži i pritisnite OK. Jačina signala prikazuje se na zaslonu.
- 8 - Ako želite spremići kanale novog primopredajnika, odaberite Spremi i pritisnite OK.
- 9 - Po potrebi više puta pritisnite  (lijevo) kako biste zatvorili izbornik.

Primopredajnik za navođenje i LNB

U nekim državama možete prilagođavati određene profesionalne postavke za primopredajnik za navođenje i svaki LNB. Te postavke koristite ili promijenite jedino ako normalna instalacija ne uspije. Ako imate nestandardnu satelitsku opremu, možete upotrijebiti ove postavke za poništavanje standardnih postavki. Neki pružatelji usluga mogu vam dati vrijednosti za primopredajnik ili LNB koje ovdje možete unijeti.

LNB izvor napajanja

LNB napajanje je uključeno prema zadanoj postavci.

Ton od 22 kHz

Ton je postavljen je na Automatski prema zadanoj postavci.

Niska LO frekvencija / Visoka LO frekvencija

Frekvencije lokalnog oscilatora postavljene su na standardne vrijednosti. Vrijednosti prilagodite isključivo u slučaju da imate posebnu opremu koja zahtijeva drukčije vrijednosti.

Problemi

Televizor ne može pronaći satelite koje želim ili je dva puta instalirao isti satelit

- Na početku instalacije provjerite je li u postavkama postavljen točan broj satelita. Televizor možete postaviti da traži jedan, dva ili 3/4 satelita.

LNB s dva izlaza ne može pronaći drugi satelit

- Ako televizor pronađe jedan satelit, ali ne može pronaći drugi, okrenite antenu za nekoliko stupnjeva. Poravnajte antenu kako biste dobili najjači signal na prvom satelitu. Provjerite indikator jačine signala na prvom satelitu na zaslonu. Dok je prvi satelit postavljen na najjači signal, odaberite Pretraži ponovo kako biste pronašli drugi satelit.
- Provjerite jesu li postavke postavljene na Dva satelita.

Promjena postavki instalacije nije riješila moj problem

- Sve postavke, sateliti i kanali spremaju se tek na kraju, kada završite instalaciju.

Svi satelitski kanali su nestali

- Ako upotrebljavate sustav Unicable, provjerite jeste li za oba ugrađena tunera dodijelili jedinstveni broj korisničkog pojasa u postavkama za Unicable. Moguće je da drugi satelitski prijemnik u sustavu Unicable upotrebljava isti broj korisničkog pojasa.

Čini se da su neki satelitski kanali nestali s popisa kanala

- Ako vam se čini da su neki kanali nestali ili da su premješteni, moguće je da je davatelj usluge promijenio lokaciju primopredajnika tih kanala. Kako biste vratili kanale na odgovarajuće mjesto na popisu kanala, možete pokušati ažurirati paket kanala.

Ne mogu ukloniti satelit

- Paketi pretplate ne dopuštaju uklanjanje satelita. Kako biste uklonili satelit, morate ponoviti cijelu instalaciju i odabrati drugi paket.

Prijem je ponekad slab

- Provjerite je li satelitska antena dobro pričvršćena. Snažan vjetar može pomaknuti antenu.
- Snijeg i kiša mogu oslabiti prijem.

Instalacija antenskih/kabelskih

Ažuriraj kanale

Automatsko ažuriranje kanala

Ako primete digitalne kanale, televizor možete postaviti na automatsko ažuriranje tih kanala.

Jednom dnevno, u 6:00, televizor ažurira kanale i pohranjuje nove kanale. Novi kanali pohranjuju se na Popis kanala i imaju oznaku *****. Kanali bez signala se uklanjaju. Televizor mora biti u stanju pripravnosti kako bi se kanali automatski ažurirali. Možete isključiti automatsko ažuriranje kanala.

Isključivanje automatskog ažuriranja...

- 1 - Pritisnite **⚙️**, odaberite **Sve postavke** i pritisnite **OK**.
- 2 - Odaberite **Kanali > Antenska/kabelska instalacija**.
- 3 - Unesite PIN kod ako je potrebno.
- 4 - Odaberite **Automatsko ažuriranje kanala**.
- 5 - Odaberite **Isključeno**.
- 6 - Pritisnite **⬅️** (lijevo) za vraćanje jedan korak ili pritisnite **⬅️ BACK** za zatvaranje izbornika.

Kada se pronađu novi kanali ili ako se kanali ažuriraju ili uklone, prikazat će se poruka prilikom pokretanja televizora. Prikaz poruke nakon svakog ažuriranja kanala možete isključiti.

Isključivanje prikaza poruke...

- 1 - Pritisnite **⚙️**, odaberite **Sve postavke** i pritisnite **OK**.
- 2 - Odaberite **Kanali > Antenska/kabelska instalacija**.
- 3 - Unesite PIN kod ako je potrebno.
- 4 - Odaberite **Poruka o ažuriranju kanala**.
- 5 - Odaberite **Isključeno**.
- 6 - Pritisnite **⬅️** (lijevo) za vraćanje jedan korak ili pritisnite **⬅️ BACK** za zatvaranje izbornika.

U određenim državama automatsko ažuriranje kanala odvija se tijekom gledanja televizije ili kada je televizor u stanju pripravnosti.

Ručno ažuriranje kanala

Ažuriranje kanala uvijek možete sami pokrenuti.

Ručno pokretanje ažuriranja kanala...

- 1 - Pritisnite **⚙️**, odaberite **Sve postavke** i pritisnite **OK**.
- 2 - Odaberite **Kanali > Antenska/kabelska instalacija**.
- 3 - Unesite PIN kod ako je potrebno.

- 4 - Odaberite **Traži kanale**.
- 5 - Odaberite **Pokreni**.
- 6 - Odaberite **Ažuriraj digitalne kanale**, odaberite **Sljedeće**.
- 7 - Odaberite **Pokreni** za ažuriranje digitalnih kanala. To može potrajati nekoliko minuta.
- 8 - Pritisnite **⬅️** (lijevo) za vraćanje jedan korak ili pritisnite **⬅️ BACK** za zatvaranje izbornika.

Ponovno instaliranje svih kanala

Možete ponovo instalirati sve kanale, bez promjene ostalih postavki televizora.

Ako je postavljen PIN kod, morat ćete ga unijeti prije ponovne instalacije kanala.

Ponovna instalacija kanala...

- 1 - Pritisnite **⚙️**, odaberite **Sve postavke** i pritisnite **OK**.
- 2 - Odaberite **Kanali > Antenska/kabelska instalacija**.
- 3 - Unesite PIN kod ako je potrebno.
- 4 - Odaberite **Traži kanale**.
- 5 - Odaberite **Pokreni** i pritisnite **OK**.
- 6 - Odaberite **Ponovno instaliraj kanale**, odaberite **Sljedeće** i pritisnite **OK**.
- 7 - Odaberite državu u kojoj se nalazite i pritisnite **OK**.
- 8 - Odaberite **Sljedeće** i pritisnite **OK**.
- 9 - Odaberite željenu vrstu instalacije, **Antenski (DVB-T)** ili **Kabelski (DVB-C)** i pritisnite **OK**.
- 8 - Odaberite **Sljedeće** i pritisnite **OK**.
- 11 - Odaberite željenu vrstu kanala, **Digitalni i analogni signali** ili **Samo digitalni kanali** i pritisnite **OK**.
- 8 - Odaberite **Sljedeće** i pritisnite **OK**.
- 13 - Odaberite **Pokreni** i pritisnite **OK** za ažuriranje digitalnih kanala. To može potrajati nekoliko minuta.
- 14 - Pritisnite **⬅️** (lijevo) za vraćanje jedan korak ili pritisnite **⬅️ BACK** za zatvaranje izbornika.

DVB-T ili DVB-C

Postavke za DVB

Način rada za frekvenciju mreže

Ako kod traženja kanala u postupku **Skeniranje frekvencija** želite koristiti metodu **Brzo skeniranje**, odaberite **Automatski**. Televizor će koristiti jednu od prethodno određenih frekvencija mreže (HC) koju koristi većina kabelskih operatera u vašoj državi.

Ako ste dobili specifičnu vrijednost frekvencije mreže za pretraživanje kanala, odaberite **Ručno**.

Frekvencija mreže

Ako za opciju **Način rada za frekvenciju mreže** odaberete **Ručno**, na ovom mjestu možete unijeti frekvenciju mreže koju ste dobili od svog kablenskog operatera. Vrijednost unesite pomoću numeričkih tipki.

Skeniranje frekvencija

Odaberite metodu traženja kanala. Možete odabrati metodu **Brzo skeniranje** i koristiti prethodno određene postavke koji koristi većina kablenskih operatera u vašoj državi.

Ako na taj način ne pronađete niti jedan kanal ili vam neki kanali nedostaju, pokušajte odabrati temeljitiju metodu **Potpuno skeniranje**. Takvo traženje i instaliranje kanala vremenski je zahtjevnije.

Veličina frekvencijskog koraka

Televizor će tražiti kanale u koracima od **8 MHz**.

Ako na taj način ne pronađete niti jedan kanal ili vam neki kanali nedostaju, možete tražiti u manjim koracima od **1 MHz**. Uz korake od 1 MHz traženje i instaliranje kanala vremenski je zahtjevnije.

Digitalni kanali

Ako znate da vaš kablenski operater ne nudi digitalne kanale, možete preskočiti traženje digitalnih kanala.

Analogni kanali

Ako znate da vaš kablenski operater ne nudi analogne kanale, možete preskočiti traženje analognih kanala.

Besplatni/kodirani

Ako imate pretplatu i CAM – modul uvjetnog pristupa (Conditional Access Module) za TV programe koji se plaćaju, odaberite opciju **Besplatni + kodirani**. Ako se niste pretplatili na kanale ili usluge koje se plaćaju, možete odabrati opciju **Samo besplatni kanali**.

Kvaliteta prijema

Možete provjeriti kvalitetu i jačinu signala kanala. Ako imate vlastitu antenu, možete promijeniti njezin položaj kako biste pokušali poboljšati prijem.

Provjera kvalitete prijema digitalnog kanala...

1 – Prijedite na kanal.

2 – Pritisnite , odaberite **Sve postavke** i pritisnite **OK**.

3 – Odaberite **Kanali > Antenska/kabelska instalacija**. Unesite PIN kod ako je potrebno.

4 – Odaberite **Digitalni: Provjera prijema**.

5 – Odaberite **Traži**. Prikazuje se digitalna frekvencija za ovaj kanal.

6 – Ponovno odaberite **Traži** i pritisnite **OK** kako biste provjerili kvalitetu signala za ovu frekvenciju. Rezultat provjere prikazuje se na zaslonu. Možete premjestiti antenu i provjeriti veze kako biste pokušali poboljšati prijem.

7 – Također možete sami promijeniti frekvenciju. Odaberite broj frekvencije jedan po jedan i za promjenu vrijednosti upotrijebite tipke **▲** (gore) ili **▼** (dolje). Odaberite **Traži** i pritisnite **OK** kako biste ponovno provjerili prijem.

8 – Po potrebi više puta pritisnite **◀** (lijevo) kako biste zatvorili izbornik.

Ručna instalacija

Analogni televizijski kanali mogu se ručno instalirati, kanal po kanal.

Ručna instalacija analognih kanala...

1 – Pritisnite , odaberite **Sve postavke** i pritisnite **OK**.

2 – Odaberite **Kanali > Antenska/kabelska instalacija**. Unesite PIN kod ako je potrebno.

3 – Odaberite **Analogni: Ručna instalacija**.

• Sustav

Kako biste postavili sustav televizora, odaberite **Sustav**.

Odaberite svoju državu ili dio svijeta u kojem se trenutno nalazite i pritisnite **OK**.

• Traži kanal

Kako biste pronašli kanal, odaberite **Traži kanal**. Možete sami unijeti frekvenciju kako biste pronašli kanal ili pustiti da ga televizor pronađe. Pritisnite **▶** (desno) kako biste odabrali **Traži** za automatsko traženje kanala. Pronađeni kanal prikazuje se na zaslonu i ako je prijem slab, ponovno pritisnite **Traži**. Ako želite pohraniti kanal, odaberite **Gotovo** i pritisnite **OK**.

• Spremi

Kanal možete pohraniti na trenutnom broju kanala ili pod novim brojem kanala. Odaberite **Spremi trenutni kanal** ili **Spremi kao novi kanal**. Nakratko se prikazuje broj novog kanala.

Te korake možete ponavljati dok ne pronađete sve dostupne analogne televizijske kanale.

Kopiranje popisa kanala

Kopiranje popisa kanala

Kopiranje popisa kanala...

- 1 - Uključite televizor. Na ovom televizoru kanali bi trebali biti instalirani.
- 2 - Priključite USB flash pogon.
- 3 - Pritisnite , odaberite **Sve postavke** i pritisnite **OK**.
- 4 - Odaberite **Kanali > Kopiranje popisa kanala**.
- 5 - Odaberite **Kopiraj na USB**. Kako biste kopirali popis kanala, možda ćete morati unijeti PIN kôd za blokadu.
- 6 - Kada kopiranje završi, iskopčajte USB flash pogon.
- 7 - Po potrebi više puta pritisnite **<** (lijevo) kako biste zatvorili izbornik.

Kopirani popis kanala sada možete prenijeti na drugi televizor tvrtke Philips.

Verzija popisa kanala

Provjera trenutne verzije popisa kanala...

- 1 - Pritisnite , odaberite **Sve postavke** i pritisnite **OK**.
- 2 - Odaberite **Kanali** i pritisnite **>** (desno) kako biste otvorili izbornik.
- 3 - Odaberite **Kopiranje popisa kanala** i odaberite **Trenutna verzija**, zatim pritisnite **OK**.
- 4 - Po potrebi više puta pritisnite **<** (lijevo) kako biste zatvorili izbornik.

Prijenos popisa kanala

Na televizore koji nisu instalirani

Ovisno o tome je li televizor već instaliran ili ne, morate koristiti drukčiju metodu prijenosa popisa kanala.

Prijenos na televizor koji još nije instaliran

- 1 - Ukopčajte utikač kako bi se pokrenula instalacija te odaberite jezik i državu. Možete preskočiti traženje kanala. Dovršite instalaciju.
- 2 - Priključite USB flash pogon na kojem se nalazi popis kanala drugog televizora.
- 3 - Da biste pokrenuli prijenos popisa kanala, pritisnite , odaberite **Sve postavke** i pritisnite **OK**.
- 4 - Odaberite **Kanali > Kopiranje popisa kanala > Kopiraj na televizor**. Unesite PIN kod ako je potrebno.
- 5 - Televizor će vas obavijestiti je li popis kanala uspješno kopiran na televizor. Iskopčajte USB flash

pogon.

Na instalirane televizore

Ovisno o tome je li televizor već instaliran ili ne, morate koristiti drukčiju metodu prijenosa popisa kanala.

Prijenos na već instalirani televizor

- 1 - Provjerite postavku države na televizoru. (Za provjeru ove postavke pogledajte poglavlje Ponovna instalacija svih kanala. Započnite ovaj postupak dok ne dodete do postavke države. Pritisnite **< BACK** kako biste otkazali instalaciju.) Ako je postavka države u redu, nastavite s korakom 2. Ako postavka države nije u redu, trebete pokrenuti ponovnu instalaciju. Pogledajte poglavlje Ponovna instalacija svih kanala i pokrenite instalaciju. Odaberite odgovarajuću državu i preskočite traženje kanala. Dovršite instalaciju. Kada završite, prijedite na korak 2.
- 2 - Priključite USB flash pogon na kojem se nalazi popis kanala drugog televizora.
- 3 - Da biste pokrenuli prijenos popisa kanala, pritisnite , odaberite **Sve postavke** i pritisnite **OK**.
- 4 - Odaberite **Kanali > Kopiranje popisa kanala > Kopiraj na televizor**. Unesite PIN kod ako je potrebno.
- 5 - Televizor će vas obavijestiti je li popis kanala uspješno kopiran na televizor. Iskopčajte USB flash pogon.

O kanalima

Popis kanala

O popisu kanala

Nakon instalacije kanala svi kanali prikazat će se na popisu kanala. Kanali se prikazuju s nazivom i logotipom ako su te informacije dostupne.

Za svaku vrstu tunera - antenski/kabelski (DVB-T/C) ili satelitski (DVB-S) - dostupan je popis kanala sa svim instaliranim kanalima. Taj popis možete filtrirati kako bi prikazivao samo televizijske ili samo radijske kanale. Ili u slučaju kada imate nekoliko instaliranih satelita, možete filtrirati kanale po satelitu.

Nakon odabira popisa kanala pritisnite strelice **▲** (gore) ili **▼** (dolje) za odabir kanala, a zatim pritisnite **OK** za gledanje odabranog kanala. Kanale s tog popisa možete odabrati samo pomoću tipki **≡ +** ili **≡ -**.

Ikone za kanale

Nakon automatskog ažuriranja kanala novi pronađeni

kanali nose oznaku ★ (zvjezdica).
Ako zaključate kanal, nosit će oznaku 🔒 (lokot).
3 najpopularnija kanala koje u tom trenutku gledaju drugi nose oznaku 1, 2 ili 3.

Radijske stanice

Ako je digitalno emitiranje dostupno, digitalni radijski kanali instaliraju se prilikom instalacije. Radijske kanale mijenjajte na isti način na koji mijenjate televizijske. Prilikom instalacije kablenskog DVB-C kanala radijskim stanicama dodjeljuju se brojevi kanala od 1001 pa nadalje.

Ovaj televizor može primiti standardno DVB emitiranje digitalne televizije. Televizor možda neće ispravno raditi s nekim davateljima sadržaja digitalne televizije koji nisu potpuno usklađeni sa zahtjevima standarda.

Otvaranje popisa kanala

Pokraj popisa sa svim kanalima za svaki tuner, antenski/kabelski ili satelitski tuner, možete odabrati filtrirani popis ili jedan od omiljenih popisa koje ste izradili.

Otvaranje trenutnog popisa kanala...

- 1 - Pritisnite **TV** za prelazak na televizor.
- 2 - Pritisnite **≡ LIST*** ili **OK** za otvaranje trenutnog popisa kanala.
- 3 - Pritisnite **← BACK** kako biste zatvorili popis kanala.

Odabir jednog od popisa kanala...

- 1 - Dok je popis kanala otvoren na zaslonu.
- 2 - Odaberite naziv popisa na vrhu popisa kanala i pritisnuti **OK** kako biste otvorili izbornik popisa.
- 3 - U izborniku popisa odaberite jedan od dostupnih popisa kanala i pritisnite **OK**.

Savjet

Lako možete mijenjati između dva tunera u izborniku Izvori.

Pritisnite **➡ SOURCES** i odaberite **Gledanje TV progr.** kako biste prešli na tuner antenski/kabelski. Odaberite **Gledaj satelit** kako biste prešli na satelitski tuner.

Televizor će uvijek otvoriti posljednji odabrani popis kanala za odabrani tuner.

* Ako je na daljinskom upravljaču dostupna tipka **≡ LIST**

Filtriranje popisa kanala

Možete filtrirati popis sa svim kanalima. Popis kanala možete postaviti tako da se u njemu prikazuju samo televizijski ili samo radijski kanali. Za antenske/kabelske kanale možete postaviti popis

tako da prikazuje besplatnih ili kodiranih kanala. Kada imate nekoliko instaliranih satelita, možete filtrirati popis satelitskih kanala po satelitu.

Postavljanje filtra na popisu sa svim kanalima...

- 1 - Pritisnite **TV**.
- 2 - Pritisnite **OK** za otvaranje trenutnog popisa kanala.
- 3 - Dok je popis kanala otvoren na zaslonu, odaberite naziv popisa na vrhu popisa kanala i pritisnuti **OK** kako biste otvorili izbornik popisa.
- 4 - U izborniku popisa odaberite popis koji želite filtrirati.
- 5 - Pritisnite **←** (lijevo) za vraćanje jedan korak ili pritisnite **←** za zatvaranje izbornika.

Pretraživanje kanala

Možete tražiti kanal kako biste ga pronašli na dugačkom popisu kanala.

Televizor može tražiti kanal na jednom od 3 glavna popisa kanala - antenski, kabelski ili satelitski.

Pretraživanje kanala...

- 1 - Pritisnite **TV**.
- 2 - Pritisnite **OK** za otvaranje trenutnog popisa kanala.
- 3 - Odaberite **⋮** u gornjem desnom kutu i pritisnite **OK**.
- 4 - Odaberite **Traži kanal** i pritisnite **OK** kako biste otvorili tekstno polje. Za unos teksta možete koristiti tipkovnicu daljinskog upravljača (ako je dostupna) ili zaslonsku tipkovnicu.
- 5 - Unesite broj, naziv ili dio naziva i odaberite **Primijeni** i pritisnite **OK**. Televizor će tražiti odgovarajuće nazive kanala na popisu koji ste odabrali.

Rezultati pretraživanja prikazuju se kao popis kanala - naziv popisa nalazi se na vrhu. Rezultati pretraživanja nestaju kada odaberete drugi popis kanala ili zatvorite popis s rezultatima pretraživanja.

Gledanje kanala

Odabir kanala

Kako biste gledali televizijske kanale, pritisnite **TV**. Televizor će otvoriti posljednji kanal koji ste gledali.

Promjena kanala

Kako biste promijenili kanale, pritisnite **≡ +** ili **≡ -**.

Ako znate broj kanala, unesite ga pomoću numeričkih tipki. Pritisnite **OK** nakon unosa broja kako biste odmah promijenili kanal.

Ako su informacije dostupne s interneta, televizor će

prikazati naziv i detalje trenutnog programa, a nakon toga naziv i detalje sljedećeg programa.

Prethodni kanal

Kako biste se vratili na prethodni kanal koji ste gledali, pritisnite **← BACK**.

Osim toga, možete odabrati kanale s **Popisa kanala**.

Blokada kanala

Otključavanje ili zaključavanje kanala

Kako biste djecu spriječili da gledaju neki kanal, možete ga blokirati. Kako biste gledali blokirani kanal, morate najprije unijeti četveroznamenkasti PIN kôd **Blokada uređaja**. Ne možete blokirati programe s povezanih uređaja.

Blokada kanala...

- 1 - Pritisnite **TV**.
- 2 - Pritisnite **OK** za otvaranje popisa kanala. Ako je nužno, promijenite popis kanala.
- 3 - Odaberite **⋮** u gornjem desnom kutu i pritisnite **OK**.
- 4 - Odaberite **zaključavanje/otključavanje** i pritisnite **OK**.
- 5 - Unesite svoj 4-znamenkasti PIN kôd ako to televizor zatraži.
- 6 - Odaberite stavku koju želite zaključati i pritisnite **OK**. Blokirani kanal nosi oznaku **🔒** (lokot).
- 7 - Pritisnite **←** (lijevo) za vraćanje jedan korak ili pritisnite **← BACK** za zatvaranje izbornika.

Deblokada kanala...

- 1 - Pritisnite **TV**.
- 2 - Pritisnite **OK** za otvaranje popisa kanala. Ako je nužno, promijenite popis kanala.
- 3 - Odaberite **⋮** u gornjem desnom kutu i pritisnite **OK**.
- 4 - Odaberite **zaključavanje/otključavanje** i pritisnite **OK**.
- 5 - Unesite svoj 4-znamenkasti PIN kôd ako to televizor zatraži.
- 6 - Pritisnite **←** (lijevo) za vraćanje jedan korak ili pritisnite **← BACK** za zatvaranje izbornika.

Ako blokirate ili deblokirate kanale na popisu kanala, PIN kôd trebate unijeti samo jednom dok ne zatvorite popis kanala.

Roditeljski nadzor

Kako biste djecu spriječili u gledanju programa koji nije prikladan njihovoj dobnoj skupini, možete postaviti klasifikaciju prema dobnoj skupini.

Programi digitalnih kanala mogu se klasificirati prema dobnoj skupini. Ako je klasifikacija prema dobnoj skupini jednaka ili viša od one koju ste postavili za

dob svojeg djeteta, program će se blokirati. Kako biste mogli gledati blokirani program, najprije morate unijeti kôd **Roditeljski nadzor**.

Postavljanje klasifikacije prema dobnoj skupini...

- 1 - Pritisnite **⚙️**, odaberite **Sve postavke** i pritisnite **OK**.
- 2 - Odaberite **Blokada uređaja > Roditeljski nadzor**.
- 3 - Unesite 4-znamenkasti kod za blokadu. Ako još niste postavili kôd, odaberite **Postavi kôd** pod **Blokada uređaja**. Unesite 4-znamenkasti kod za blokadu i potvrdite ga. Nakon toga možete postaviti klasifikaciju prema dobnoj skupini.
- 4 - U opciji **Roditeljski nadzor** odaberite dobnu skupinu.
- 5 - Po potrebi više puta pritisnite **←** (lijevo) kako biste zatvorili izbornik.

Kako biste isključili klasifikaciju prema dobnoj skupini, odaberite **Ništa**. Međutim, u nekim državama morate postaviti klasifikaciju prema dobnoj skupini.

Kod nekih televizijskih kuća / dobavljača usluga televizor blokira samo programe za starije dobne skupine. Roditeljski nadzor postavljen je za sve kanale.

Opcije kanala

Otvaranje opcija

Tijekom gledanja kanala možete postaviti određene opcije.

Ovisno o vrsti kanala koji gledate ili ovisno o postavljenim postavkama televizora dostupne su neke opcije.

Otvaranje izbornika s opcijama...

- 1 - Dok gledate kanal, pritisnite **+ OPTIONS > ≡ Preference**.
- 2 - Ponovo pritisnite **+OPTIONS** za zatvaranje.

Preimenuj kanal

Tijekom gledanja kanala možete ga preimenovati.

Promjena naziva kanala...

- 1 - Dok gledate kanal, pritisnite **+ OPTIONS**.
- 2 - Odaberite **≡ Preference > Preimenuj kanal**.
- 3 - Pomoću zaslonske tipkovnice izbrisite trenutni naziv i unesite novi.

Common Interface

Ako ste umetnuli CAM u jedan od Common Interface utora, možete prikazati CAM informacije i informacije operatera ili postavljati određene postavke za CAM.

Prikaz CAM informacija...

- 1 - Pritisnite **➤** SOURCES.
- 2 - Odaberite vrstu kanala za koji koristite CAM, Gledanje TV progr. ili Gledanje satelita.
- 3 - Pritisnite **+** OPTIONS i odaberite **≡** Preference > Common Interface.
- 4 - Odaberite odgovarajući utor Common Interface i pritisnite **➤** (desno).
- 5 - Odaberite televizijskog operatera za CAM i pritisnite **OK**. Slijede zaslone od televizijskog operatera.

HbbTV na ovom kanalu

Ako ne želite pristup HbbTV stranicama na određenom kanalu, možete blokirati HbbTV stranice samo za taj kanal.

- 1 - Prijedite na kanal na kojem želite blokirati HbbTV stranice.
- 2 - Pritisnite **+** OPTIONS, odaberite Preference > HbbTV na ovom kanalu i pritisnite **➤** (desno).
- 3 - Odaberite **Isključeno** i pritisnite **OK**.
- 4 - Pritisnite **◀** (lijevo) za vraćanje jedan korak ili pritisnite **←** BACK za zatvaranje izbornika.

Potpuno blokiranje HbbTV-a na televizoru...

- 1 - Pritisnite **⚙**, odaberite Sve postavke i pritisnite **OK**.
- 2 - Odaberite **Općenite postavke** > **Napredno** > **HbbTV**.
- 3 - Odaberite **Isključeno** i pritisnite **OK**.
- 4 - Pritisnite **◀** (lijevo) za vraćanje jedan korak ili pritisnite **←** BACK za zatvaranje izbornika.

Informacije o kanalu

Možete pregledati tehnička svojstva određenog kanala, primjerice je li digitalni ili analogni itd.

Prikaz tehničkih informacija kanala...

- 1 - Prijedite na kanal.
- 2 - Pritisnite **+** OPTIONS, odaberite **≡** Preference i pritisnite **OK**.
- 3 - Odaberite **Informacije o kanalu** i pritisnite **OK**.
- 4 - Kako biste zatvorili ovaj zaslon, pritisnite **OK**.

Informacije o programu

Prikaz pojedinosti o programu

Za učitavanje pojedinosti odabranog programa...

- 1 - Prijedite na kanal.
- 2 - Pritisnite **+** OPTIONS, odaberite **≡** Preference i pritisnite **OK**.
- 3 - Odaberite **Informacije o programu** i

pritisnite **OK** za prikaz informacija o programu.

4 - Pritisnite **←** BACK kako biste zatvorili.

Mono/Stereo

Zvuk analognog kanala možete postaviti na Mono ili Stereo.

Postavljanje na Mono ili Stereo...

- 1 - Prijedite na analogni kanal.
- 2 - Pritisnite **+** OPTIONS i odaberite **≡** Preference > Mono/Stereo i pritisnite **➤** (desno).
- 3 - Odaberite **Mono** ili **Stereo** i pritisnite **OK**.
- 4 - Pritisnite **◀** (lijevo) za vraćanje jedan korak ili pritisnite **←** BACK za zatvaranje izbornika.

Odabir videozapisa

Digitalni televizijski kanali mogu imati više videosignala (višekanalno emitiranje), razne perspektive ili kutove gledanja istog događaja ili različite programe na istom televizijskom kanalu. Ako su takvi televizijski kanali dostupni, na televizoru će se prikazati poruka.

Dual I-II

Ako audio signal sadrži dva audio jezika, ali jedan jezik ili oba nemaju naznaku jezika, ova je opcija dostupna.



Mapiranje kanala

Ako na početku nema informacija o programu, možete mapirati kanal kako biste dobili više informacija o programu.

- 1 - Pritisnite **≡** TV GUIDE i navigacijskim tipkama odaberite **⋮** u sredini i pritisnite **OK**.
- 2 - Odaberite **TV vodič** > **S interneta** i pritisnite **OK**.
- 3 - Odaberite jedan od kanala u TV vodiču i potom pritisnite **OK** kako biste gledali odabrani kanal.
- 4 - Dok gledate kanal, pritisnite **+** OPTIONS.
- 5 - Odaberite **≡** Preference > **Mapiraj kanal**.
- 6 - Odaberite stavku s popisa i pritisnite **OK**.
- 7 - Odaberite **Mapiraj kanal**.
- 8 - Po dovršetku informacije o mapiranom kanalu možete vidjeti u programu.

Promjena logotipa

Ako na početku nema informacija o programu, više informacija o programu možete dobiti prateći sljedeće korake.





- 1 - Pritisnite  TV GUIDE i navigacijskim tipkama odaberite  u sredini i pritisnite **OK**.
- 2 - Odaberite **TV vodič >** **Od televizijske kuće i** pritisnite **OK**.
- 3 - Odaberite jedan od kanala u TV vodiču i potom pritisnite **OK** kako biste gledali odabrani kanal.
- 4 - Dok gledate kanal, pritisnite **+ OPTIONS**.
- 5 - Odaberite  **Preference >** **Promijeni logotip**.
- 6 - Odaberite stavku s popisa i pritisnite **OK**.
- 7 - Odaberite **Promijeni logotip**.
- 8 - Po dovršetku informacije o mapiranom kanalu možete vidjeti u programu.

Omiljeni kanali

O omiljenim kanalima





Na popisu omiljenih kanala možete sakupiti kanale koje volite.

Možete izraditi 8 popisa omiljenih kanala radi jednostavne promjene kanala. Svakom popisu omiljenih kanala možete dati zaseban naziv. Samo na omiljenom popisu kanalima možete mijenjati redoslijed.

Nakon odabira omiljenog popisa pritisnite strelice  (gore) ili  (dolje) za odabir kanala, a zatim pritisnite **OK** za gledanje odabranog kanala. Kanale s tog popisa možete odabrati samo pomoću tipki  **+** ili  **-**.

Izrada popisa omiljenih





Izrada popisa omiljenih kanala s popisa kanala...

- 1 - Pritisnite  za prelazak na televizor.
- 2 - Pritisnite  **LIST** (ako je dostupno) ili **OK** za otvaranje trenutnog popisa kanala.
- 3 - Odaberite  u gornjem desnom kutu i pritisnite **OK**.
- 4 - Odaberite **Izradi popis omiljenih i** pritisnite **OK**.
- 5 - Na popisu lijevo odaberite kanal koji želite kao omiljeni i pritisnite **+ OPTIONS**. Kanali se na popisu prikazuju na desnoj strani redoslijedom kojim ih dodajete. Za poništavanje odaberite kanal na popisu na lijevoj strani i ponovo pritisnite **+ OPTIONS**. Također možete odabrati raspon kanala pritiskanjem  (dolje) kako biste odabrali posljednji kanal u rasponu koji želite dodati i zatim pritisnite **OK**.
- 6 - Kako biste završili dodavanje kanala, pritisnite **← BACK**.
- 7 - Televizor će zatražiti preimenovanje popisa

omiljenih kanala. Možete se poslužiti zaslonskom tipkovnicom ili pritisnuti **← BACK** za skrivanje zaslonske tipkovnice, a potom tipkovnicom na stražnjoj strani daljinskog upravljača (ako je dostupna) unesite novi naziv.

Ako je popis kanala dugačak, umjesto toga možete odabrati bilo koji kanal, pritisnuti **+ OPTIONS** za otvaranje izbornika s opcijama, zatim odabrati **Izradi popis omiljenih i** pritisnuti **OK**.

Izrada novog popisa omiljenih kanala kopiranjem postojećeg popisa omiljenih kanala...



- 1 - Pritisnite  za prelazak na televizor.
- 2 - Pritisnite  **LIST** (ako je dostupno) ili **OK** za otvaranje trenutnog popisa kanala.
- 3 - Odaberite  u gornjem desnom kutu i pritisnite **OK**.
- 4 - Odaberite **Dupliciraj popis omiljenih i** pritisnite **OK**.
- 5 - Na popisu lijevo odaberite kanal koji želite kao omiljeni i pritisnite **+ OPTIONS**. Kanali se na popisu prikazuju na desnoj strani redoslijedom kojim ih dodajete. Za poništavanje odaberite kanal na popisu na lijevoj strani i ponovo pritisnite **+ OPTIONS**. Također možete odabrati raspon kanala pritiskanjem  (dolje) kako biste odabrali posljednji kanal u rasponu koji želite dodati i zatim pritisnite **OK**.
- 6 - Kako biste završili dodavanje kanala, pritisnite **← BACK**.
- 7 - Televizor će zatražiti preimenovanje **popisa omiljenih kanala**. Možete se poslužiti zaslonskom tipkovnicom ili pritisnuti **← BACK** za skrivanje zaslonske tipkovnice, a potom tipkovnicom na stražnjoj strani daljinskog upravljača (ako je dostupna) unesite novi naziv.

Možete dodati određeni raspon kanala odjednom ili započeti **popis omiljenih kanala** dupliciranjem popisa kanala sa svim kanalima i onda izbrisati kanale koje ne želite.

Dodavanje raspona kanala

Kako biste odjednom dodali raspon kanala u uzastopnom slijedu na **popis omiljenih kanala**, možete koristiti opciju **Odabir raspona**.

Dodavanje raspona kanala...





- 1 - Pritisnite  **SOURCE**.
- 2 - Odaberite **Omiljeni**.
- 3 - Otvorite **popis omiljenih kanala** u koji želite dodati raspon kanala.
- 4 - Odaberite  u gornjem desnom kutu i pritisnite **OK**.
- 5 - Odaberite **Uredi popis omiljenih i** pritisnite **OK**.
- 6 - Na popisu lijevo odaberite prvi kanal u rasponu koji želite dodati i pritisnite **OK**.

- 7 - Pritisnite  (dolje) kako biste odabrali zadnji kanal u rasponu koji želite dodati i zatim pritisnite **OK**.
- 8 - Odaberite Dodaji pritisnite **OK**. Kanali su označeni s lijeve strane.

Preimenovanje popisa omiljenih kanala

Popis omiljenih kanala možete i preimenovati.



Preimenovanje popisa omiljenih kanala...

- 1 - Pritisnite  **SOURCE**.
- 2 - Odaberite **Omiljeni**.
- 3 - Odaberite  u gornjem desnom kutu i pritisnite **OK**.
- 4 - Odaberite **Preimenuj popis omiljenih kanala** i pritisnite **OK**.
- 5 - Poslužite se zaslonskom tipkovnicom ili pritisnite  **BACK** za skrivanje zaslonske tipkovnice, a potom tipkovnicom na stražnjoj strani daljinskog upravljača (ako je dostupna) unesite novi naziv.
- 6 - Kada završite, okrenite daljinski upravljač, odaberite **Zatvori** i pritisnite **OK**.
- 7 - Pritisnite  **BACK** kako biste zatvorili popis kanala.

Uklanjanje popisa omiljenih

Ukloniti možete samo **popis omiljenih kanala**.





Uklanjanje **popisa omiljenih kanala**...

- 1 - Pritisnite  **SOURCE**.
- 2 - Odaberite **Omiljeni**.
- 3 - Odaberite  u gornjem desnom kutu i pritisnite **OK**.
- 4 - Odaberite **Ukloni popis omiljenih kanala** i pritisnite **OK**.

Promijeni raspored kanala

Redoslijed kanala možete mijenjati samo na **popisu omiljenih**.

Promjena redoslijeda kanala...

- 1 - Pritisnite  **SOURCES** i odaberite **Omiljeni**.
- 2 - Otvorite **popis omiljenih** kojemu želite promijeniti redoslijed.
- 3 - Odaberite  u gornjem desnom kutu i pritisnite **OK**.
- 4 - Odaberite **Promijeni redoslijed kanala** i pritisnite **OK**.
- 5 - Na **popisu omiljenih** odaberite kanal kojemu želite promijeniti redoslijed i pritisnite **OK**. (Kanal se označava sivim okvirom)
- 6 - Pomoću tipki  (gore) ili  (dolje) pomaknite kanal na željeno mjesto.

- 7 - Pritisnite **OK** kako biste potvrdili novu lokaciju.
- 8 - Istu metodu možete koristiti za promjenu redoslijeda kanala do zatvaranja **popisa omiljenih** tipkom  **BACK**.

Teletekst

Stranice teleteksta

Kako biste otvorili teletekst, dok gledate televizijske kanale pritisnite **TEXT**.

Kako biste zatvorili teletekst, ponovo pritisnite **TEXT**.

Odabir stranice teleteksta

Odabir stranice . . .

- 1 - Unesite broj stranice pomoću numeričkih tipki.
- 2 - Krećite se pomoću navigacijskih tipki.
- 3 - Pritisnite tipku u boji za odabir neke od stavki označenih bojama na dnu zaslona.

Podstranice teleteksta

Pod brojem stranice teleteksta može biti nekoliko podstranica. Brojevi podstranica prikazuju se na traci pokraj broja glavne stranice.

Za odabir podstranice pritisnite  ili .



T.O.P. Stranice teleteksta

Neke televizijske kuće nude T.O.P. teleteksta. Otvaranje T.O.P. teleteksta unutar teleteksta – pritisnite **+ OPTIONS** i odaberite **T.O.P. pregled**.

Omiljene stranice

Televizor sastavlja popis posljednjih 10 otvorenih stranica teleteksta. Možete ih jednostavno ponovo otvoriti u stupcu **Omiljene stranice** teleteksta.

- 1 - U prikazu teleteksta odaberite  (srce) u gornjem lijevom kutu zaslona kako bi se prikazao stupac **omiljenih stranica**.

- 2 - Pritisnite  (dolje) ili  (gore) kako biste odabrali broj stranice i pritisnite **OK** za otvaranje stranice.

Popis možete očistiti odabirom **Očisti omiljene stranice**.

Pretraživanje teleteksta

Možete odabrati riječ i zatim u tekstu pretražiti sva pojavljivanja te riječi.

- 1 - Otvorite stranicu teleteksta i pritisnite **OK**.
- 2 - Pomoću tipki sa strelicama odaberite riječ ili broj.
- 3 - Ponovo pritisnite **OK** kako biste odmah prešli na sljedeće mjesto na kojem se pojavljuje određena riječ ili broj.
- 4 - Ponovo pritisnite **OK** za prelazak na sljedeće mjesto.
- 5 - Kako biste zaustavili pretraživanje, pritišćite  (gore) dok više ništa ne bude odabrano.

Teletekst s povezanom uređaja

Neki uređaji koji primaju televizijske kanale mogu nuditi i teletekst.

Otvaranje teleteksta s povezanog uređaja . . .

1 - Pritisnite **SOURCES** odaberite uređaj i pritisnite **OK**.

2 - Dok gledate kanal na uređaju, pritisnite **+ OPTIONS**, odaberite **Prikaz tipki uređaja** i odaberite tipku **≡** te pritisnite **OK**.

3 - Pritisnite **← BACK** kako biste sakrili tipke uređaja.

4 - Kako biste zatvorili teletekst, ponovo pritisnite **← BACK**.

Digitalni tekst (samo u Ujedinjenom Kraljevstvu)

Neke televizijske kuće koje emitiraju digitalne programe nude namjenske usluge digitalnog teksta ili interaktivne televizije na svojim digitalnim televizijskim kanalima. To obuhvaća uobičajeni teletekst za koji se upotrebljavaju numeričke tipke, tipke sa strelicama i tipke u boji za odabir i kretanje.

Kako biste zatvorili digitalni tekst, pritisnite **← BACK**.

Opcije teleteksta

U teletekstu pritisnite **+ OPTIONS** za sljedeći odabir...

- **Zamrzavanje stranice**

Zaustavljanje automatske rotacije podstranica.

- **Dvostruki prikaz na zaslonu / Pun zaslon**

Prikaz televizijskog kanala i teleteksta jednoga uz drugi.

- **T.O.P. pregled**

Otvaranje T.O.P. teleteksta.

- **Povećavanje**

Povećanje stranice teleteksta radi ugodnijeg čitanja.

- **Prikaz**

Prikaz skrivenih informacija na stranici.

- **Listanje podstranica**

Listanje podstranica kada su one dostupne.

- **Sakrij/prikaži omiljene stranice**

Za skrivanje ili prikaz popisa omiljenih stranica.

- **Brisanje omiljenih stranica**

Brisanje popisa omiljenih stranica.

- **Jezik**

Promjena skupine znakova koje teletekst koristi za ispravan prikaz.

- **Teletekst 2.5**

Aktivacija Teleteksta 2.5 koji nudi više boja i bolju grafiku.

Postavljanje teleteksta

Jezik teleteksta

Neke televizijske kuće koje emitiraju digitalne programe nude više jezika teleteksta.

Postavljanje primarnog i sekundarnog jezika

teleteksta . . .

1 - Pritisnite **⚙**, odaberite **Sve postavke** i pritisnite **OK**.

2 - Odaberite **Regija i jezik** i pritisnite **>** (desno) kako biste otvorili izbornik.

3 - Odaberite **Jezik > Primarni teletekst** ili **Sekundarni teletekst**.

4 - Odaberite željene jezike teleteksta.

5 - Po potrebi više puta pritisnite **←** (lijevo) kako biste zatvorili izbornik.

Teletekst 2.5

Ako je dostupan, Teletekst 2.5 pruža više boja i bolju grafiku. Teletekst 2.5 je aktiviran kao standardna tvornička postavka.

Isključivanje Teleteksta 2.5...

1 - Pritisnite **TEXT**.

2 - Dok je teletekst otvoren na zaslonu, pritisnite **+ OPTIONS**.

3 - Odaberite **Teletekst 2.5 > Isključi** i pritisnite **OK**.

4 - Po potrebi više puta pritisnite **←** (lijevo) kako biste zatvorili izbornik.

Povezivanje uređaja

O povezivanju

Vodič za mogućnost povezivanja

Prilikom povezivanja uređaja s televizorom uvijek koristite najkvalitetniju vezu koja je dostupna. Osim toga, koristite kvalitetne kabele kako bi se osigurao dobar prijenos slike i zvuka.

Kada povežete uređaj, televizor će prepoznati vrstu uređaja i svakom uređaju dati odgovarajući naziv sukladno njegovoj vrsti. Ako želite, naziv možete promijeniti. Ako je postavljen odgovarajući naziv uređaja, televizor će automatski prijeći na idealne postavke kada odaberete taj uređaj u izborniku Izvori.

Ako vam je potrebna pomoć za povezivanje nekoliko uređaja s televizorom, možete otvoriti Vodič za povezivanje tvrtke Philips. Vodič pruža informacije o povezivanju i kabelima koje trebate koristiti.

Posjetite www.connectivityguide.philips.com

Priključnica za antenu

Ako imate set-top box (digitalni prijemnik) ili snimač, kabele za antenu priključite tako da se prijenos signala antene odvija preko set-top box uređaja i/ili snimača do televizora. Na taj način antena i set-top box mogu slati moguće dodatne kanale snimaču.

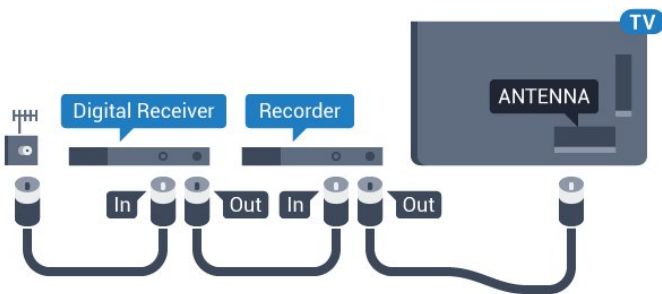

HDMI priključnice

HDMI kvaliteta

HDMI veza omogućava sliku i zvuk najbolje kvalitete. Jedan HDMI kabel kombinira video i audio signale. Upotrijebite HDMI kabel za televizijski signal.

Za najbolji prijenos kvalitete signala koristite HDMI kabel velike brzine prijenosa i nemojte koristiti HDMI

kabel dulji od 5 m.

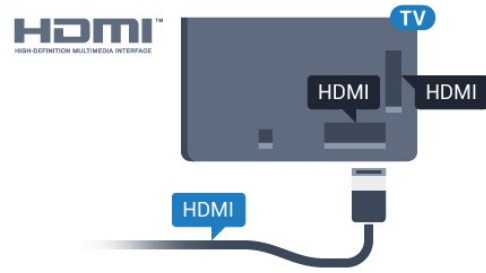

Zaštita od kopiranja

HDMI kabele podržavaju HDCP (High-bandwidth Digital Contents Protection / Zaštita digitalnih sadržaja s velikom širinom pojasa). HDCP je signal za zaštitu od kopiranja sadržaja s DVD ili Blu-ray Disc medija. Poznat je i pod nazivom DRM (Digital Rights Management).

HDMI ARC

Sve HDMI priključnice na televizoru imaju HDMI ARC (Audio Return Channel).

Ako uređaj, obično sustav kućnog kina (HTS), ima i HDMI ARC priključnicu, povežite ga s bilo kojom HDMI priključnicom na televizoru. Uz HDMI ARC ne morate priključivati dodatni audio kabel koji šalje zvuk televizijske slike sustavu kućnog kina. HDMI ARC kombinira oba signala.

Možete koristiti bilo koju HDMI priključnicu na televizoru za priključivanje sustava kućnog kina, ali ARC je dostupan za samo 1 uređaj/priključnicu u isto vrijeme.

HDMI MHL

HDMI MHL vam omogućuje slanje sadržaja koji gledate na Android pametnom telefonu ili tabletu na zaslon televizora.

Priključnica HDMI 4 na ovom televizoru obuhvaća MHL 2.0 (Mobile High-Definition Link).

Ova žična veza pruža odličnu stabilnost i protok podataka, malo kašnjenje i kvalitetnu reprodukciju zvuka, a nema smetnji bežičnih veza. Uz to, MHL veza omogućuje punjenje baterije pametnog telefona ili tableta. Iako je povezan, vaš mobilni uređaj neće se puniti kada je televizor u stanju pripravnosti.

Informirajte se o tome koji pasivni MHL kabel odgovara vašem mobilnom uređaju. Na primjer, uz HDMI priključnicu za televizor na jednoj strani, informirajte se na koju vrstu priključnice trebate priključiti pametni telefon ili tablet.

MHL, Mobile High-Definition Link i logotip MHL zaštitni su znakovi ili registrirani zaštitni znakovi tvrtke



HDMI CEC – EasyLink

HDMI veza omogućava sliku i zvuk najbolje kvalitete. Jedan HDMI kabel kombinira video i audio signale. Koristite HDMI kabel za televizijski signal visoke rezolucije (HD). Za najbolji prijenos kvalitete signala koristite HDMI kabel velike brzine prijenosa i nemojte koristiti HDMI kabel dulji od 5 m.

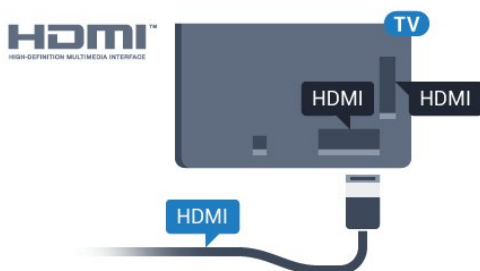

EasyLink HDMI CEC

Ako su vaši uređaji povezani HDMI kabelom i imaju EasyLink, njima možete upravljati pomoću daljinskog upravljača televizora. Opcija EasyLink HDMI CEC mora biti postavljena na Uključeno i na televizoru i na povezanom uređaju.

EasyLink omogućava upravljanje povezanim uređajem pomoću daljinskog upravljača televizora. EasyLink koristi HDMI CEC (Consumer Electronics Control) za komunikaciju s povezanim uređajima. Uređaji moraju podržavati HDMI CEC i moraju biti povezani HDMI vezom.

Postavke za EasyLink

Značajka EasyLink uključena je prema zadanoj opciji. Provjerite jesu li sve postavke za HDMI CEC ispravno postavljene na povezanim uređajima koji imaju EasyLink. EasyLink možda neće raditi s uređajima drugih robnih marki.

HDMI CEC kod uređaja drugih robnih marki

HDMI CEC funkcionalnost ima razne nazive, ovisno o proizvođaču. Primjeri: Anynet, Aquos Link, Bravia Theatre Sync, Kuro Link, Simplink i Viera Link. Ne podržavaju sve robne marke EasyLink.

Nazivi HDMI CEC funkcije navedeni kao primjer vlasništvo su odgovarajućih vlasnika.

DVI na HDMI

Ako još uvijek posjedujete uređaj koji ima samo DVI priključnicu, možete ga povezati s bilo kojom HDMI priključnicom pomoću adaptera DVI na HDMI.

Koristite adapter DVI na HDMI ako uređaj ima samo DVI ulaz. Upotrijebite jednu od HDMI priključnica i priključite Audio L/R kabel (mini priključak od 3,5 mm) u Audio ulaz za zvuk, na stražnjoj strani televizora.

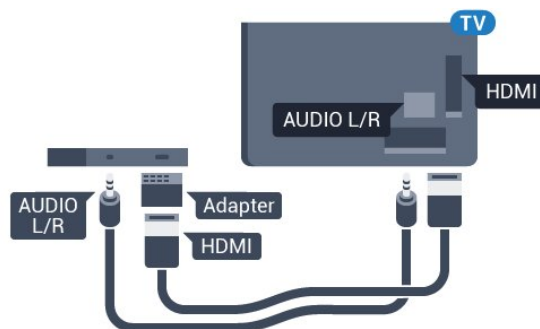

Zaštita od kopiranja

DVI i HDMI kabeli podržavaju HDCP (High-bandwidth Digital Contents Protection). HDCP je signal za zaštitu od kopiranja sadržaja s DVD ili Blu-ray Disc medija. Poznat je i pod nazivom DRM (Digital Rights Management).

6.3

Y Pb Pr – komponentni

Y Pb Pr – komponentni video predstavlja vrlo kvalitetnu vezu.

YPbPr veza može se koristiti za televizijske signale visoke rezolucije (HD). Pored Y, Pb i Pr signala, dodajte i lijevi i desni audio signali za zvuk.

Boje YPbPr (zeleni, plavi, crveni) priključnice prilikom povezivanja uskladite s utikačima kabela. Koristite Audio L/R cinch kabel ako vaš uređaj ima podršku i za zvuk.

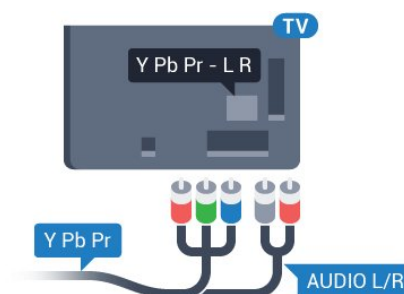

Scart

SCART predstavlja vezu dobre kvalitete.

SCART veza može se koristiti za CVBS i RGB video signale, ali ne za televizijske signale visoke rezolucije (HD). SCART kombinira video i audio signale. SCART veza podržava NTSC reprodukciju.

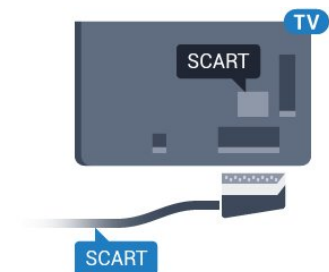

Audio izlaz – optički

Audio izlaz – optički predstavlja vrlo kvalitetnu vezu za zvuk.

Ova optička veza može prenositi 5.1-kanalni zvuk. Ako uređaj, obično sustav kućnog kina (HTS), nema HDMI ARC priključnicu, ovu vezu možete koristiti uz audio ulaz – optički na kućnom kinu. Audio izlaz – optički šalje zvuk s televizora na sustav kućnog kina.

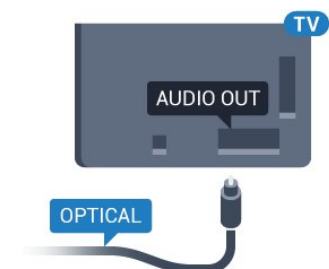

CAM s pametnom karticom – CI+

Više o sučelju CI+

Napomena: Nije podržano u državama azijsko-pacifičke regije, Bliskog istoka i Afrike.

CI+

Ovaj televizor podržava CI+ Conditional Access .

CI+ omogućava gledanje premium HD programa, kao što su filmovi i sportski sadržaji dobavljača televizijskih sadržaja koji emitiraju digitalnu televiziju u vašoj regiji. Televizijski operateri kodiraju te programe, a dekodiraju ih uz prethodno plaćeni CI+ modul. Dobavljači digitalnih televizijskih sadržaja osiguravaju CI+ modul (Conditional Access Module - CAM) i odgovarajuću pametnu karticu kada se pretplatite na njihove premium programe. Ti programi imaju visoku razinu zaštite od kopiranja.

Više informacija o odredbama i uvjetima zatražite od televizijskog operatera koji emitira digitalne programe.



Pametna kartica

Dobavljači digitalnih televizijskih sadržaja osiguravaju CI+ modul (Conditional Access Module - CAM) i odgovarajuću pametnu karticu kada se pretplatite na njihove premium programe.

Umetnite pametnu karticu u CAM modul. Pogledajte upute koje ste dobili od operatera.

Umetanje CAM modula u televizor...

- 1 - Pravilan način umetanja naznačen je na CAM modulu. Nepravilnim umetanjem mogu se oštetiti CAM modul i televizor.
- 2 - Na stražnjoj strani televizora, s prednjom stranom CAM modula okrenutom prema vama, pažljivo umetnite CAM u utor **COMMON INTERFACE**.
- 3 - CAM modul pogurajte do kraja. Trajno ga ostavite u utoru.

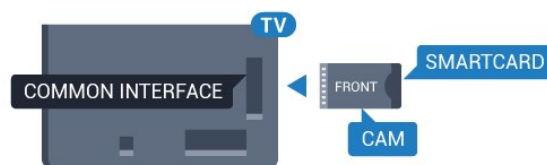

Po uključivanju televizora možda će biti potrebno nekoliko minuta da se CAM aktivira. Ako je CAM umetnut, a pretplata plaćena (metode pretplate mogu se razlikovati), možete gledati kodirane kanale koje podržava CAM pametna kartica.

CAM i pametna kartica namijenjeni su isključivo vašem televizoru. Ako izvadite CAM, više nećete moći gledati kodirane kanale koje podržava CAM.

Lozinke i PIN kodovi

Kako biste gledali kanale nekih CAM modula, morate unijeti PIN kôd. Prilikom postavljanja PIN koda za CAM, preporučujemo da koristite isti kôd koji koristite za otključavanje televizora.

Postavljanje PIN koda za CAM...

- 1 - Pritisnite **SOURCES**.
- 2 - Odaberite vrstu kanala za koji koristite CAM za Gledanje TV progr.
- 3 - Pritisnite **+ OPTIONS** i odaberite **Common Interface**.
- 4 - Odaberite televizijskog operatera CAM modula. Slijede zasloni od televizijskog operatera. Slijedite upute na zaslonu kako biste potražili postavku za PIN kôd.

6.7

Sustav kućnog kina – HTS

Povezivanje pomoću priključnice HDMI ARC

Pomoću HDMI kabela povežite sustav kućnog kina (HTS) s televizorom. Možete povezati Soundbar tvrtke Philips ili sustav kućnog kina s ugrađenim reproduktorom diskova.

HDMI ARC

Ako sustav kućnog kina ima HDMI ARC priključnicu, za povezivanje možete koristiti bilo koju HDMI priključnicu na televizoru. Uz HDMI ARC ne trebate povezivati dodatni audio kabel. HDMI ARC kombinira oba signala.

Sve HDMI priključnice na televizoru mogu imati ARC (Audio Return Channel) signal. No nakon povezivanja sustava kućnog kina televizor može slati ARC signal samo toj HDMI priključnici.

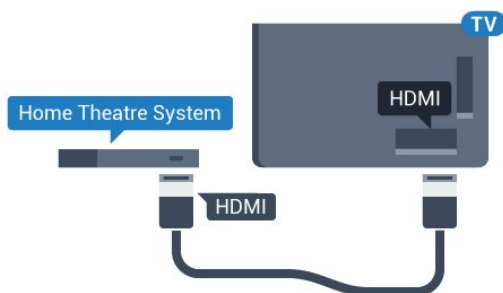

Usklađivanje zvuka i slike

Ako zvuk ne odgovara slici na zaslonu, na većini sustava kućnog kina s reproduktorom diskova može se postaviti odgoda kako bi zvuk i slika uskladili.

Povezivanje pomoću HDMI kabela

Pomoću HDMI kabela povežite sustav kućnog kina (HTS) s televizorom. Možete povezati Soundbar tvrtke Philips ili sustav kućnog kina s ugrađenim reproduktorom diskova.

Ako sustav kućnog kina nema HDMI ARC priključnicu, dodajte optički audio kabel (Toslink) za slanje zvuka televizijske slike sustavu kućnog kina.

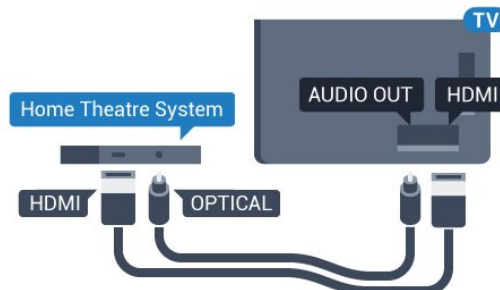

Usklađivanje zvuka i slike

Ako zvuk ne odgovara slici na zaslonu, na većini sustava kućnog kina s reproduktorom diskova može se postaviti odgoda kako bi zvuk i slika uskladili.

Problemi sa zvukom sustava kućnog kina

Zvuk s mnogo šuma

Ako gledate videozapis s priključenog USB flash pogona ili povezanog računala, zvuk sa sustava kućnog kina mogao bi biti izobličen. Taj šum čuje se kada audio ili video datoteka ima DTS zvuk, ali sustav kućnog kina nema DTS obradu zvuka. To možete popraviti tako da **Format audio izlaza** televizora postavite na **Stereo (nekomprimirano)**.

Pritisnite **⚙** za **Sve postavke > Zvuk > Napredno > Format audio izlaza**.

Nema zvuka

Ako zvuk s televizora ne čujete putem sustava kućnog kina, provjerite jeste li HDMI kabel priključili u **HDMI ARC** priključnicu na sustavu kućnog kina. Sve HDMI priključnice na televizoru podržavaju HDMI ARC.

6.8

Pametni telefoni i tableti

Za povezivanje pametnog telefona ili tableta s televizorom možete koristiti bežičnu ili žičnu vezu.

Bežična

Za bežičnu vezu na pametni telefon ili tablet

preuzmite Philips TV Remote App iz omiljene trgovine aplikacijama.

Žična mreža

Za žičnu vezu koristite HDMI 4 MHL priključnicu na stražnjoj strani televizora. Kako biste pronašli više informacija, u izborniku **Pomoć** odaberite **Ključne riječi** i potražite **HDMI MHL**.

6.9

Blu-ray Disc reproduktor

Koristite **HDMI kabel velike brzine** kako biste povezali Blu-ray Disc reproduktor i televizor.

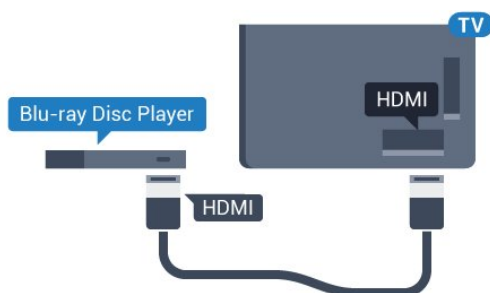

Ako Blu-ray Disc reproduktor ima EasyLink HDMI CEC, njime možete upravljati pomoću daljinskog upravljača za televizor.

6.10

DVD reproduktor

Za povezivanje DVD reproduktora s televizorom koristite HDMI kabel.

Umjesto toga, možete upotrijebiti SCART kabel ako uređaj nema HDMI priključnicu.

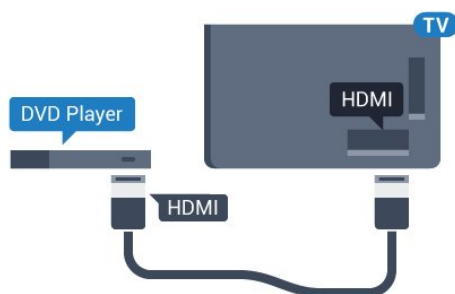

Ako je DVD reproduktor povezan HDMI kabelom i ima EasyLink CEC, njime možete upravljati pomoću daljinskog upravljača za televizor.

6.11

Bluetooth – zvučnici i upravljači

Što je potrebno

S ovim televizorom možete povezati bežični uređaj koristeći Bluetooth® - bežični zvučnik, niskotonac, sound bar ili slušalice. Također možete povezati upravljač za igranje koristeći Bluetooth LE.

Kako biste reproducirali zvuk s televizora na bežičnom zvučniku, morate upariti bežični zvučnik s televizorom. Možete upariti bežične zvučnike i najviše 4 uređaja s tehnologijom Bluetooth LE (niska potrošnja energije). Televizor istovremeno može reproducirati zvuk samo na jednom zvučniku. Ako povežete niskotonac, zvuk se reproducira na televizoru i niskotoncu. Ako povežete sound bar, zvuk se reproducira samo na sound bar zvučniku.

Pažnja - usklađivanje zvuka i slike

Mnogi sustavi zvučnika s tehnologijom Bluetooth imaju veliko tzv. 'kašnjenje'. Veliko kašnjenje znači da zvuk kasni za slikom, zbog čega oni nisu usklađeni. Prije nego što kupite sustav bežičnih Bluetooth zvučnika, informirajte se o najnovijim modelima i potražite uređaj s malim kašnjenjem. Zatražite savjet od prodavača.

Uparivanje uređaja

Bežični zvučnik postavite na udaljenost manju od 5 metara od televizora. Specifične informacije o uparivanju i dometu bežične veze potražite u korisničkom priručniku uređaja. Provjerite je li na televizoru uključena postavka Bluetooth.

Možete koristiti bežični upravljač za igranje nakon što ga uparite. Kad je bežični zvučnik uparen, možete ga odabrati za reprodukciju zvuka televizora. Nakon što uparite uređaj, ne trebate ga ponovno uparivati ako ne uklonite uređaj.

Uparivanje bežičnog zvučnika s televizorom...

- 1 - Uključite bežični zvučnik i stavite ga unutar dometa televizora.
- 2 - Pritisnite , odaberite **Sve postavke** i pritisnite **OK**.
- 3 - Odaberite **Bežična veza i mreže** i pritisnite **>** (desno) kako biste otvorili izbornik.
- 4 - Odaberite **Bluetooth > Traži Bluetooth uređaj**.
- 5 - Odaberite **Pokreni** i pritisnite **OK**. Slijedite upute na zaslonu. Uparit ćete uređaj s televizorom, a televizor će spremi vezu. Ako ste postigli maksimalan broj uparenih uređaja, prvo morati razdvojiti upareni uređaj.
- 6 - Odaberite vrstu uređaja (slušalice, niskotonac, ...).

7 - Po potrebi više puta pritisnite < (lijevo) kako biste zatvorili izbornik.

Odabir uređaja

Kad je uparen bežični Bluetooth zvučnik, možete ga odabrati za reprodukciju zvuka televizora.

Za odabir zvučnika za reprodukciju zvuka s televizora...

- 1 - Pritisnite ⚙️, odaberite **Zvučnici** i pritisnite **OK**.
- 2 - Odaberite željeni sustav zvučnika.
- 3 - Po potrebi više puta pritisnite < (lijevo) kako biste zatvorili izbornik.

Uklanjanje uređaja

Možete priključiti ili isključiti bežični Bluetooth uređaj. Kad je Bluetooth uređaj priključen, možete koristiti upravljač za igranje ili reproducirati zvuk televizora putem bežičnog zvučnika. Također možete ukloniti bežični Bluetooth uređaj. Ako uklonite Bluetooth uređaj, on više neće biti uparen.

Za uklanjanje ili isključivanje bežičnog uređaja...

- 1 - Pritisnite ⚙️, odaberite **Sve postavke** i pritisnite **OK**.
- 2 - Odaberite **Bežična veza i mreže**.
- 3 - Odaberite **Bluetooth** > **Ukloni uređaj**.
- 4 - Na popisu odaberite bežični uređaj.
- 5 - Odaberite **Prekid veze** ili **Ukloni**.
- 6 - Odaberite **OK**.
- 7 - Po potrebi više puta pritisnite < (lijevo) kako biste zatvorili izbornik.

Uključivanje ili isključivanje opcije Bluetooth

Za povezivanje bežičnih Bluetooth uređaja provjerite je li Bluetooth uključen.

Da biste uključili Bluetooth...

- 1 - Pritisnite ⚙️, odaberite **Sve postavke** i pritisnite **OK**.
- 2 - Odaberite **Bežična veza i mreže**.
- 3 - Odaberite **Bluetooth** > **Uklj./isklj. Bluetooth**.
- 4 - Odaberite **Uključeno** ili **Isključeno**.
- 5 - Po potrebi više puta pritisnite < (lijevo) kako biste zatvorili izbornik.

6.12

Slušalice

Možete priključiti slušalice u priključnicu 🎧 na stražnjoj strani televizora. Priključak je mini priključak od 3,5 mm. Glasnoću slušalica možete zasebno prilagoditi.

Prilagodba glasnoće...

- 1 - Pritisnite ⚙️ i odaberite **Glasnoća slušalica**.
- 2 - Pritisnite strelice ▲ (gore) ili ▼ (dolje) kako biste prilagodili vrijednost.
- 3 - Po potrebi više puta pritisnite < (lijevo) kako biste zatvorili izbornik.

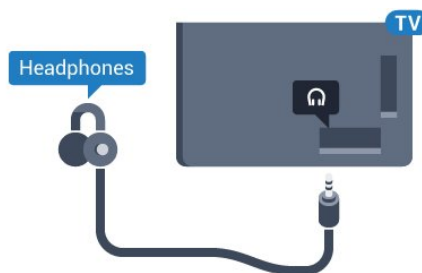

6.13

Igraća konzola

HDMI

Kako biste dobili najbolju kvalitetu, za povezivanje igraće konzole s televizorom koristite HDMI kabel velike brzine.

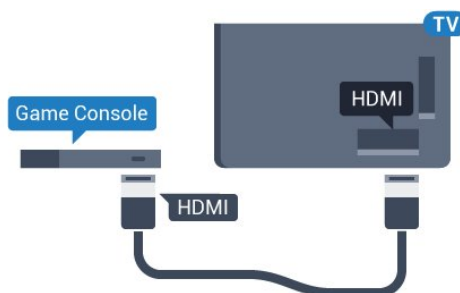

Y Pb Pr

Povežite igraću konzolu komponentnim video kabelom (Y Pb Pr) i audio L/R kabelom s televizorom.

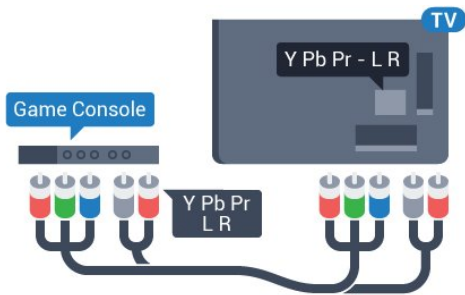

Scart

Povežite igraću konzolu kompozitnim kablom (CVBS) i audio L/R kablom s televizorom.

Ako vaša igraća konzola ima samo Video (CVBS) i Audio L/R izlaz, koristite adapter Video Audio L/R na SCART (prodaje se zasebno) za povezivanje sa SCART priključnicom.

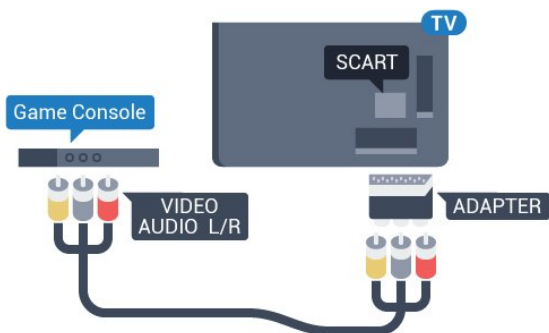

Najbolja postavka

Prije nego što počnete igrati igru s povezanе igraće konzole, savjetujemo vam da televizor postavite na idealnu postavku **Igra**.

Za postavljanje televizora na idealnu postavku...

- 1 - Pritisnite **⚙**, odaberite **Sve postavke** i pritisnite **OK**.
- 2 - Odaberite **Slika** i pritisnite **➤** (desno) kako biste otvorili izbornik.
- 3 - Odaberite **Stil slike > Igra**.
- 4 - Po potrebi više puta pritisnite **⬅** (lijevo) kako biste zatvorili izbornik.

6.14

Upravljač za igranje

Povezivanje upravljača za igranje

Kako biste na televizoru igrali igre s interneta, možete povezati određene bežične upravljače. Možete koristiti upravljače s USB nano prijemnikom ili upravljače s Bluetoothom.

Za povezivanje upravljača s USB nano prijemnikom...

- 1 - Priključite mali nano prijemnik u jednu od USB priključnica na bočnoj strani televizora. Bežični nano prijemnik isporučuje se s upravljačem za igranje.
- 2 - Ako je upravljač za igranje uključen, možete ga koristiti.

Drugi upravljač za igranje možete priključiti u drugu USB priključnicu na bočnoj strani televizora.

Problemi

Rješavanje mogućih smetnji s drugim bežičnim uređajima na televizoru...

- Koristite USB produžni kabel i pomaknite nano prijemnik približno 1 metar od televizora.
- Umjesto toga, možete upotrijebiti USB čvorište pod naponom povezano s televizorom i u njega priključiti nano prijemnike.

6.15

USB tvrdi disk

Što je potrebno

Ako priključite USB tvrdi disk, možete pauzirati ili snimati digitalne televizijske sadržaje (DVB ili slično emitiranje).

Minimalni prostor na disku

- Pauziranje
Kako biste pauzirali emitirani sadržaj, treba vam tvrdi disk koji podržava USB 2.0 s najmanje 4 GB prostora.
- Snimanje
Kako biste pauzirali i snimili emitirani sadržaj, treba vam disk s najmanje 250 GB prostora.

Instalacija

Prije pauziranja ili snimanja televizijskog programa morate povezati i formatirati USB tvrdi disk. Formatiranjem će se ukloniti sve datoteke s USB tvrdog diska.

- 1 - Povežite USB tvrdi disk s jednom od **USB** priključnica na televizoru. Prilikom formatiranja nemojte povezivati drugi USB uređaj u drugu USB priključnicu.
- 2 - Uključite USB tvrdi disk i televizor.

3 - Dok se na televizoru prikazuje digitalni televizijski kanal, pritisnite **||** (Pauza). Pauzom će se pokrenuti formatiranje.

Slijedite upute na zaslonu.

Kada se USB tvrdi disk formatira, ostavite ga stalno povezanog.

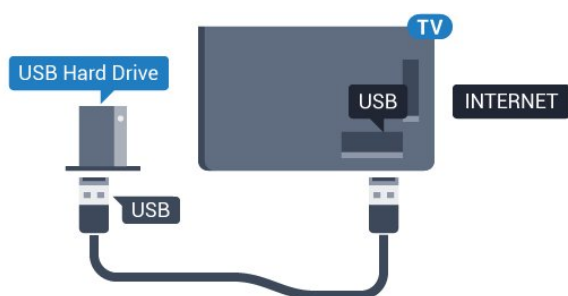

Upozorenje

USB tvrdi disk formatiran je isključivo za ovaj televizor, što znači da spremljene snimke ne možete koristiti na drugom televizoru ili na računalu. Nemojte kopirati niti mijenjati datoteke snimki na USB tvrdom disku pomoću bilo koje računalne aplikacije. Time će se snimke oštetiti. Prilikom formatiranja drugog USB tvrdog diska, sadržaj na prethodnom će se izgubiti. USB tvrdi disk koji je instaliran na televizor morat ćete ponovo formatirati kako biste ga mogli koristiti na računalu.

Formatiranje

Prije pauziranja ili snimanja televizijskog programa ili spremanja aplikacija morate povezati i formatirati USB tvrdi disk. Formatiranjem će se ukloniti sve datoteke s USB tvrdog diska. Ako želite snimiti programe s podacima iz vodiča kroz televizijske programe s interneta, prije instaliranja USB tvrdog diska prvo morate podesiti internetsku vezu.

Upozorenje

USB tvrdi disk formatiran je isključivo za ovaj televizor, što znači da spremljene snimke ne možete koristiti na drugom televizoru ili na računalu. Nemojte kopirati niti mijenjati datoteke snimki na USB tvrdom disku pomoću bilo koje računalne aplikacije. Time će se snimke oštetiti. Prilikom formatiranja drugog USB tvrdog diska, sadržaj na prethodnom će se izgubiti. USB tvrdi disk koji je instaliran na televizor morat ćete ponovo formatirati kako biste ga mogli koristiti na računalu.

Za formatiranje USB tvrdog diska...

- 1 - Povežite USB tvrdi disk s jednom od USB priključnica na televizoru. Prilikom formatiranja nemojte povezivati drugi USB uređaj u drugu USB priključnicu.
- 2 - Uključite USB tvrdi disk i televizor.
- 3 - Dok se na televizoru prikazuje digitalni televizijski

kanal, pritisnite **||** (Pauza). Pauzom će se pokrenuti formatiranje. Slijedite upute na zaslonu.

4 - Televizor će vas pitati želite li koristiti USB tvrdi disk za spremanje aplikacija. Potvrdite ako želite.

5 - Kada se USB tvrdi disk formatira, ostavite ga stalno povezanog.

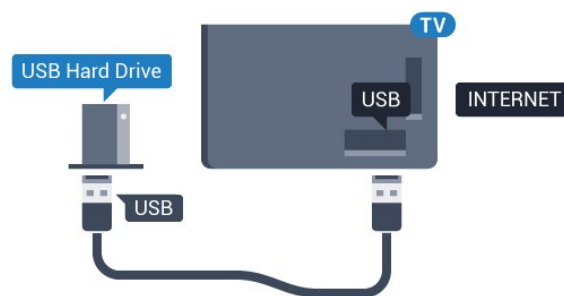

6.16

USB tipkovnica

Povezivanje

Povežite USB tipkovnicu (USB-HID) za unos teksta na televizoru.

Za povezivanje koristite jednu od USB priključnica.



Konfiguracija

Instalacija tipkovnice

Kako biste instalirali USB tipkovnicu, uključite televizor i priključite USB tipkovnicu na jednu od USB priključnica na televizoru. Kada televizor prvi put prepozna tipkovnicu, možete odabrati raspored tipkovnice i testirati odabir. Ako najprije odaberete ćirilčni ili grčki raspored tipkovnice, možete odabrati sekundarni latinični raspored.

Promjena postavke rasporeda tipkovnice nakon odabira rasporeda...

- 1 - Pritisnite **⚙**, odaberite **Sve postavke** i pritisnite **OK**.
- 2 - Odaberite **Općenite postavke** i pritisnite **>** (desno) kako biste otvorili izbornik.
- 3 - Odaberite **Postavke USB tipkovnice** i pokrenite postavljanje tipkovnice.

Posebne tipke

Tipke za unos teksta

- Tipka Enter = OK
- Backspace = brisanje znaka ispred pokazivača
- Tipke sa strelicama = kretanje unutar tekstnog polja
- Kako biste promijenili raspored tipkovnice dok je postavljen sekundarni raspored, istovremeno pritisnite tipke **Ctrl + razmaknica**.

Tipke za aplikacije i internetske stranice

- Tab i Shift + Tab = sljedeće i prethodno
- Home = pomicanje na vrh stranice
- End = pomicanje na dno stranice
- Page Up = prelazak na gornju stranicu
- Page Down = prelazak na donju stranicu
- + = povećavanje za jedan korak
- - = smanjenje za jedan korak
- * = prilagođavanje web-stranice širini zaslona

6.17

USB Flash pogon

Možete prikazivati fotografije ili reproducirati glazbu i videozapise s povezanog USB flash pogona.

Umetnite USB flash pogon u jednu od **USB** priključnica na televizoru dok je televizor uključen.



Televizor će prepoznati flash pogon i otvoriti popis njegovih sadržaja.

Ako se popis sadržaja ne prikaže automatski, pritisnite **SOURCES** te odaberite **USB**.

Kako biste prekinuli prikaz sadržaja USB flash pogona, pritisnite **TV EXIT** ili odaberite drugu aktivnost.

Kako biste prekinuli vezu s USB flash pogonom, možete ga izvući u bilo koje vrijeme.

Kako biste pronašli više informacija o gledanju ili reprodukciji sadržaja s USB flash pogona, u izborniku **Pomoć** odaberite **Ključne riječi** i potražite **Fotografije, videozapisi i glazba**.

6.18

Fotoaparat

Kako biste prikazali fotografije pohranjene na digitalnom fotoaparatu, fotoaparat možete izravno povezati s televizorom.

Za povezivanje koristite jednu od **USB** priključnica na televizoru. Nakon povezivanja uključite fotoaparat.

Ako se popis sadržaja ne prikaže automatski, pritisnite **SOURCES** te odaberite **USB**. Fotoaparat ćete možda morati postaviti za prijenos sadržaja koristeći protokol PTP (Picture Transfer Protocol). Pročitajte korisnički priručnik digitalnog fotoaparata.

Kako biste pronašli više informacija o prikazu fotografija, u izborniku **Pomoć** odaberite **Ključne riječi** i potražite **Fotografije, videozapisi i glazba**.

6.19

Kamkorder

HDMI

Kako biste dobili najbolju kvalitetu, koristite HDMI kabel za povezivanje kamkordera s televizorom.

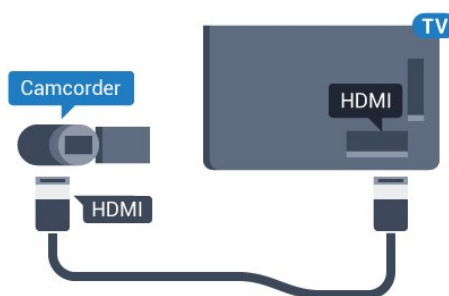

LR za audio i video / Scart

Za povezivanje kamkordera možete koristiti HDMI, YPbPr ili SCART priključnicu. Ako kamkorder ima samo Video (CVBS) i Audio L/R izlaz, koristite adapter Video Audio L/R na SCART (prodaje se zasebno) kako biste ga povezali sa SCART priključnicom.

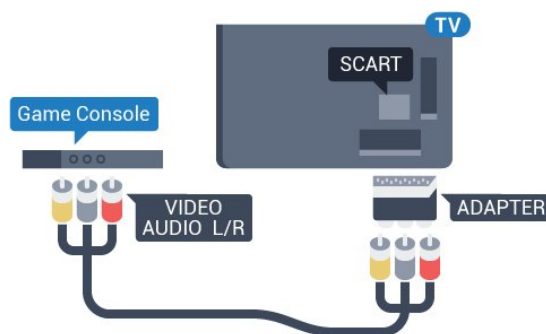

Računalo

Povezivanje

Računalo možete povezati s televizorom i televizor koristiti kao računalni monitor.

Uz HDMI

Pomoću HDMI kabela povežite računalo s televizorom.

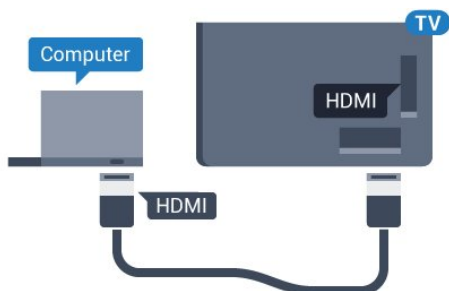

Uz DVI na HDMI

Umjesto toga, možete koristiti adapter DVI na HDMI (prodaje se zasebno) kako biste računalo priključili na HDMI priključnicu, a audio L/R kabel (mini priključak od 3,5 mm) za priključivanje u AUDIO IN L/R priključnicu na stražnjoj strani televizora.

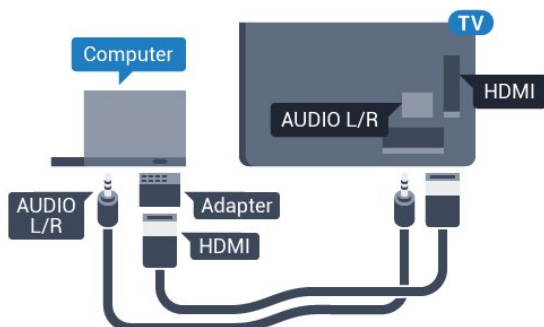

Idealna postavka

Ako povežete računalo, savjetujemo vam da vezi putem koje je računalo povezano dodate ispravan naziv vrste uređaja u izborniku Izvori. Ako zatim u izborniku Izvori promijenite postavku na **Računalo**, televizor će se automatski postaviti na idealnu postavku za računalo.

Za postavljanje televizora na idealnu postavku...

- 1 - Pritisnite , odaberite **Sve postavke** i pritisnite **OK**.
- 2 - Odaberite **Slika** i pritisnite **>** (desno) kako biste otvorili izbornik.
- 3 - Odaberite **Napredno > Računalo**.
- 4 - Odaberite **Uključeno** ili **Isključeno**.
- 5 - Po potrebi više puta pritisnite **<** (lijevo) kako

Povezivanje Android TV-a

Mreža i internet

Kućna mreža

Da biste iskoristili sve mogućnosti svog televizora Android TV tvrtke Philips, morate ga povezati s internetom.

Povežite televizor na kućnu mrežu s brzom internetskom vezom. Televizor s usmjerivačem možete povezati bežično ili pomoću kabela.

Povezivanje s mrežom

Bežična veza

Što je potrebno

Kako biste televizor bežično povezali s internetom, treba vam Wi-Fi usmjerivač s internetskom vezom.



Koristite brzu (širokopojasnu) vezu s internetom.



Uspostavljanje veze

Bežična

Uspostavljanje bežične veze...

- 1 - Pritisnite , odaberite Sve postavke i pritisnite OK.
- 2 - Odaberite Bežična veza i mreže i pritisnite  (desno) kako biste otvorili izbornik.
- 3 - Odaberite Žično ili Wi-Fi > Povezivanje s mrežom.
- 4 - Odaberite Bežična mreža.
- 5 - Na popisu pronađenih mreža odaberite svoju bežičnu mrežu. Ako vaša mreža nije na popisu zato što je naziv mreže skriven (isključili ste SSID-a usmjerivača), odaberite Dodaj novu mrežu kako biste



sami unijeli naziv mreže.

6 - Ovisno o vrsti usmjerivača, unesite šifru za šifriranje – WEP, WPA ili WPA2. Ako ste za ovu mrežu ranije unijeli šifru za šifriranje, možete odabrati OK kako biste odmah uspostavili vezu.

7 - Po uspostavljanju veze prikazat će se poruka.



Uključivanje/isključivanje funkcije Wi-Fi

Prije uspostavljanja veze provjerite je li funkcija Wi-Fi uključena...

- 1 - Pritisnite , odaberite Sve postavke i pritisnite OK.
- 2 - Odaberite Bežična veza i mreže i pritisnite  (desno).
- 3 - Odaberite Žično ili Wi-Fi > Uklj./isklj. Wi-Fi.
- 4 - Ako je isključena, odaberite Uključeno i pritisnite OK.

WPS

Ako usmjerivač ima WPS, možete izravno uspostaviti vezu s usmjerivačem bez traženja mreža. Ako u bežičnoj mreži imate uređaje koji koriste WEP sustav sigurnosnog šifriranja, ne možete koristiti WPS.

- 1 - Pritisnite , odaberite Sve postavke i pritisnite OK.
- 2 - Odaberite Bežična veza i mreže i pritisnite  (desno) kako biste otvorili izbornik.
- 3 - Odaberite Žično ili Wi-Fi > Povezivanje s mrežom.
- 4 - Odaberite WPS.
- 5 - Idite na usmjerivač, pritisnite gumb WPS i vratite se na televizor u roku od 2 minute.
- 6 - Odaberite Poveži kako bi se uspostavila veza.
- 7 - Po uspostavljanju veze prikazat će se poruka.

WPS s PIN kodom

Ako usmjerivač ima WPS s PIN kodom, možete izravno uspostaviti vezu s usmjerivačem bez traženja mreža. Ako u bežičnoj mreži imate uređaje koji koriste WEP sustav sigurnosnog šifriranja, ne možete koristiti WPS.

- 1 - Pritisnite , odaberite Sve postavke i pritisnite OK.
- 2 - Odaberite Bežična veza i mreže i pritisnite  (desno) kako biste otvorili izbornik.
- 3 - Odaberite Žično ili Wi-Fi > Povezivanje s mrežom.
- 4 - Odaberite WPS s PIN kodom.
- 5 - Zapišite prikazani 8-znamenasti PIN kôd i unesite ga u softver usmjerivača na računalu. U priručniku za usmjerivač saznat ćete gdje u softveru usmjerivača trebate unijeti PIN kôd.
- 6 - Odaberite Poveži kako bi se uspostavila veza.
- 7 - Po uspostavljanju veze prikazat će se poruka.

Problemi

Bežična mreža nije pronađena ili u njoj postoje smetnje

- Mikrovalne pećnice, DECT telefoni ili drugi Wi-Fi 802.11b/g/n uređaji u blizini mogu ometati bežičnu mrežu.
- Provjerite dopuštaju li vatrozidovi u mreži pristup bežičnoj vezi televizora.
- Ako bežična mreža u vašem domu ne radi ispravno, pokušajte koristiti žičnu mrežu.

Internet ne radi

- Ako je veza s usmjerivačem ispravna, provjerite vezu usmjerivača s internetom.

Veza računala i interneta je spora

- U korisničkom priručniku za bežični usmjerivač potražite informacije o dometu u zatvorenom prostoru, brzini prijenosa i drugim čimbenicima kvalitete signala.
- Za uporabu usmjerivača potrebna je brza (širokopojasna) internetska veza.

DHCP

- Ako uspostavljanje veze ne uspije, možete provjeriti DHCP (Dynamic Host Configuration Protocol) postavku usmjerivača. DHCP treba biti uključen.

Žična veza

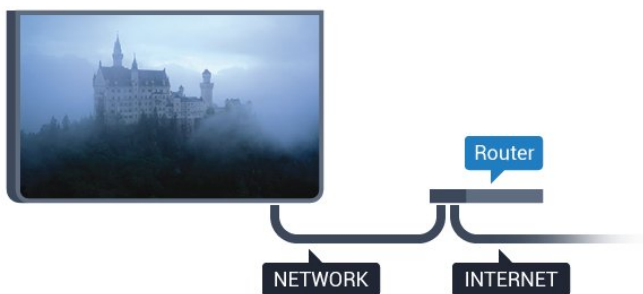

Što je potrebno

Za povezivanje televizora s internetom treba vam mrežni usmjerivač povezan s internetom. Koristite brzu (širokopojasnu) vezu s internetom.



Uspostavljanje veze

Uspostavljanje žične veze...

- 1 - Povežite usmjerivač s televizorom pomoću mrežnog kabela (Ethernet kabel**).
- 2 - Provjerite je li usmjerivač uključen.
- 3 - Pritisnite , odaberite Sve postavke i pritisnite OK.
- 4 - Odaberite Bežična veza i mreže i pritisnite  (desno) kako biste otvorili izbornik.
- 5 - Odaberite Žično ili Wi-Fi > Povezivanje s mrežom.

6 - Odaberite Žična mreža. Televizor neprestano traži vezu s mrežom.

7 - Po uspostavljanju veze prikazat će se poruka.

Ako uspostavljanje veze ne uspije, možete provjeriti DHCP postavku usmjerivača. DHCP treba biti uključen.



**Kako bi se zadovoljili EMC propisi, koristite obloženi FTP kat. 5E Ethernet kabel.

Postavke mreže

Prikaz postavki mreže

Ovdje možete pregledati sve trenutne postavke mreže. IP i MAC adresa, jačina signala, brzina, metoda šifriranja itd.



Prikaz trenutnih postavki mreže...

- 1 - Pritisnite , odaberite Sve postavke i pritisnite OK.
- 2 - Odaberite Bežična veza i mreže i pritisnite  (desno) kako biste otvorili izbornik.
- 3 - Odaberite Žično ili Wi-Fi > Prikaz postavki mreže.
- 4 - Po potrebi više puta pritisnite  (lijevo) kako biste zatvorili izbornik.

Mrežna konfiguracija

Ako ste napredni korisnik i želite instalirati mrežu sa statičkom IP adresom, postavite televizor na Statički IP.



Postavljanje televizora na statički IP...

- 1 - Pritisnite , odaberite Sve postavke i pritisnite OK.
- 2 - Odaberite Bežična veza i mreže i pritisnite  (desno) kako biste otvorili izbornik.
- 3 - Odaberite Žično ili Wi-Fi > Mrežna konfiguracija i pritisnite OK.
- 4 - Odaberite Statički IP i pritisnite OK kako biste omogućili opciju Konfiguracija statične IP adrese.
- 5 - Odaberite Konfiguracija statične IP adrese i konfigurirajte vezu.
- 6 - Možete postaviti broj za IP adresu, mrežnu masku, pristupnik, DNS 1 ili DNS 2.
- 7 - Po potrebi više puta pritisnite  (lijevo) kako biste zatvorili izbornik.

Uključivanje pomoću funkcije Wi-Fi (WoWLAN)

Ovaj televizor možete uključiti s pametnog telefona ili tableta ako je televizor u stanju pripravnosti. Opcija Uključivanje pomoću funkcije Wi-Fi (WoWLAN) mora biti uključena.



Uključivanje pomoću funkcije WoWLAN...

- 1 - Pritisnite , odaberite Sve postavke i pritisnite OK.
- 2 - Odaberite Bežična veza i mreže i pritisnite  (desno) kako biste otvorili izbornik.
- 3 - Odaberite Žično ili Wi-Fi > Uključivanje pomoću funkcije Wi-Fi (WoWLAN).
- 4 - Odaberite Uključeno.
- 5 - Po potrebi više puta pritisnite  (lijevo) kako biste zatvorili izbornik.

Uključivanje Wi-Fi veze

Wi-Fi vezu na televizoru možete uključiti ili isključiti.



Uključivanje Wi-Fi veze...

- 1 - Pritisnite , odaberite Sve postavke i pritisnite OK.
- 2 - Odaberite Bežična veza i mreže i pritisnite  (desno) kako biste otvorili izbornik.
- 3 - Odaberite Žično ili Wi-Fi > Uklj./isklj. Wi-Fi.
- 4 - Odaberite Uključeno.
- 5 - Po potrebi više puta pritisnite  (lijevo) kako biste zatvorili izbornik.

Digital Media Renderer - DMR

Ako se multimedijske datoteke ne reproduciraju na televizoru, provjerite je li uključen Digital Media Renderer. DMR je uključen prema tvorničkim postavkama.



Uključivanje opcije DMR...

- 1 - Pritisnite , odaberite Sve postavke i pritisnite OK.
- 2 - Odaberite Bežična veza i mreže i pritisnite  (desno) kako biste otvorili izbornik.
- 3 - Odaberite Žično ili Wi-Fi > Digital Media Renderer – DMR.
- 4 - Odaberite Uključeno.
- 5 - Po potrebi više puta pritisnite  (lijevo) kako biste zatvorili izbornik.

Wi-Fi Smart Screen

Kako biste gledali digitalne televizijske kanale na pametnom telefonu ili tabletu koristeći TV Remote App tvrtke Philips, morate uključiti Wi-Fi Smart Screen. Neki kodirani kanali možda neće biti dostupni na vašem mobilnom uređaju.

Uključivanje opcije Wi-Fi Smart Screen...

- 1 - Pritisnite , odaberite Sve postavke i pritisnite OK.
- 2 - Odaberite Bežična veza i mreže i pritisnite  (desno) kako biste otvorili izbornik.
- 3 - Odaberite Žično ili Wi-Fi > Pametni zaslon





putem Wi-Fi veze.

- 4 - Odaberite Uključeno.
- 5 - Po potrebi više puta pritisnite  (lijevo) kako biste zatvorili izbornik.

Mrežni naziv televizora

Ako u kućnoj mreži imate više od jednog televizora, televizoru možete dati jedinstveni naziv.



Promjena naziva televizora...

- 1 - Pritisnite , odaberite Sve postavke i pritisnite OK.
- 2 - Odaberite Bežična veza i mreže i pritisnite  (desno) kako biste otvorili izbornik.
- 3 - Odaberite Žično ili Wi-Fi > Mrežni naziv televizora.
- 4 - Unesite naziv pomoću tipkovnice na zaslonu.
- 5 - Kako biste završili, pritisnite .
- 6 - Po potrebi više puta pritisnite  (lijevo) kako biste zatvorili izbornik.

Čišćenje internetske memorije

Opcija Brisanje internetske memorije omogućava brisanje svih internetskih datoteka i podataka za prijavu na televizoru kao što su lozinke, kolačići i povijest.

Brisanje internetske memorije...

- 1 - Pritisnite , odaberite Sve postavke i pritisnite OK.
- 2 - Odaberite Bežična veza i mreže i pritisnite  (desno) kako biste otvorili izbornik.
- 3 - Odaberite Žično ili Wi-Fi > Očisti internetsku memoriju.
- 4 - Odaberite OK kako biste potvrdili.
- 5 - Po potrebi više puta pritisnite  (lijevo) kako biste zatvorili izbornik.

Dijeljenje datoteka

Televizor se može povezati s drugim uređajima u vašoj bežičnoj mreži, kao što su računalo ili pametni telefon. Možete koristiti računalo sa sustavom Microsoft Windows ili Apple OS X.

Na ovom televizoru možete otvarati fotografije, glazbene datoteke i videozapise pohranjene na računalo. Koristite noviji softver poslužitelja medija s DLNA certifikatom.

Google račun

Prijava



Da biste iskoristili sve mogućnosti svog televizora Android TV tvrtke Philips, možete se prijaviti na Google sa svojim Google računom.

Prijava će vam omogućiti igranje vaših omiljenih igara na telefonu, tabletu i televizoru. Također ćete dobiti prilagođene preporuke videozapisa i glazbe na početnom zaslonu televizora, kao i pristup uslugama YouTube, Google Play i drugim aplikacijama.

Prijava

Upotrijebite svoj postojeći **Google račun** da biste se prijavili na Google na televizoru. Google račun sastoji se od adrese e-pošte i lozinke. Ako još nemate Google račun, izradite ga na računalu ili tabletu (accounts.google.com). Za igranje igara putem usluge Google Play potreban vam je Google+ profil. Ako se niste prijavili prilikom prve instalacije televizora, možete to učiniti kasnije.

Za prijavu nakon instalacije televizora...

- 1 - Pritisnite , odaberite **Sve postavke** i pritisnite **OK**.
- 2 - Odaberite **Postavke za Android** i pritisnite **OK**.
- 3 - Pritisnite  (dolje) i odaberite **Osobno > Dodaj račun** i pritisnite **OK**.
- 4 - Pritisnite **OK** u izborniku **PRIJAVA**.
- 5 - Pomoću zaslonske tipkovnice unesite svoju adresu e-pošte i pritisnite **OK**.
- 6 - Unesite lozinku i pritisnite istu malu tipku **OK** da biste se prijavili.
- 7 - Po potrebi više puta pritisnite  (lijevo) kako biste zatvorili izbornik.

Ako se želite prijaviti s drugim Google računom, prvo se odjavite i zatim ponovno prijavite s drugim računom.

Postavke za Android

Možete postaviti ili prikazati više određenih postavki ili informacija za Android. Možete pronaći popis aplikacija instaliranih na vašem televizoru i količinu prostora koju zauzimaju. Možete postaviti jezik koji želite koristiti za glasovno pretraživanje. Možete konfigurirati tipkovnicu na zaslonu ili dopustiti aplikacijama da koriste vašu lokaciju. Istražite različite postavke za Android.

Posjetite www.support.google.com/androidtv za više informacija o tim postavkama.

Za otvaranje postavki...

- 1 - Pritisnite , odaberite **Sve postavke** i pritisnite **OK**.

- 2 - Odaberite **Postavke za Android**.
- 3 - Istražite različite postavke za Android.
- 4 - Pritisnite  **BACK**, ako je potrebno, kako biste zatvorili izbornik.

Galerija aplikacija tvrtke Philips



Aplikacije tvrtke Philips

Povežite televizor s internetom i uživajte u aplikacijama koje je odabrala tvrtka Philips. Aplikacije **Galerija aplikacija tvrtke Philips** izradene su posebno za televizor. Preuzimanje i instalacija aplikacija iz galerije aplikacija besplatni su.

Kolekcija aplikacija u galeriji aplikacija tvrtke Philips može se razlikovati ovisno o državi ili regiji.

Neke aplikacije iz galerije aplikacija prethodno su instalirane na vašem televizoru. Za instalaciju ostalih aplikacija iz galerije aplikacija morat ćete prihvatiti odredbe uporabe. Postavke privatnosti možete postaviti prema vlastitim željama.



Za instalaciju aplikacije iz galerije aplikacija...

- 1 - Pritisnite  **HOME**.
- 2 - Pomaknite se prema dolje i odaberite  **Kolekcija tvrtke Philips >  Galerija aplikacija** i pritisnite **OK**.
- 3 - Odaberite ikonu aplikacije i pritisnite **OK**.
- 4 - Odaberite **Instaliraj** i pritisnite **OK**.

Odredbe uporabe

Za instalaciju i uporabu aplikacija iz galerije aplikacija tvrtke Philips potrebno je prihvatiti odredbe uporabe. Ako ih niste prihvatili prilikom prve instalacije televizora, možete to učiniti kasnije. Kad prihvatite odredbe uporabe, neke aplikacije će odmah postati dostupne i moći ćete pretražiti galeriju aplikacija tvrtke Philips za instalaciju drugih aplikacija.

Za prihvaćanje odredbi uporabe nakon instalacije televizora...

- 1 - Pritisnite  **HOME** i odaberite **Kolekcija tvrtke Philips > Galerija aplikacija** te pritisnite **OK** za otvaranje galerije aplikacija.
- 2 - Možete odabrati **Odredbe uporabe** i zatim pritisnuti **OK** kako biste ih pročitali.
- 3 - Odaberite **Prihvati** i pritisnite **OK**. Ne možete poništiti ovo odobrenje.
- 4 - Pritisnite  **BACK** kako biste zatvorili izbornik.

Postavke privatnosti

Možete postaviti neke postavke privatnosti za aplikacije iz galerije aplikacija tvrtke Philips.

- Možete dopustiti slanje tehničkih statistika tvrtki Philips.
- Možete dopustiti osobne preporuke.
- Možete dopustiti kolačiće.
- Možete uključiti blokadu uređaja za aplikacije koje su namijenjene osobama starijim od 18 godina.

Za postavljanje postavki privatnosti galerije aplikacija tvrtke Philips...

- 1 - Pritisnite HOME i odaberite Kolekcija tvrtke Philips > Galerija aplikacija te pritisnite OK za otvaranje galerije aplikacija.
- 2 - Možete odabrati Pravila privatnosti i zatim pritisnuti OK.
- 3 - Odaberite svaku od postavki i pritisnite OK kako biste dopustili ili zabranili. Možete pročitati detalje svake postavke.
- 4 - Pritisnite BACK kako biste zatvorili izbornik.

7.4

Postavke za Android

Možete postaviti ili prikazati više određenih postavki ili informacija za Android. Možete pronaći popis aplikacija instaliranih na vašem televizoru i količinu prostora koju zauzimaju. Možete postaviti jezik koji želite koristiti za glasovno pretraživanje. Možete konfigurirati tipkovnicu na zaslonu ili dopustiti aplikacijama da koriste vašu lokaciju. Istražite različite postavke za Android.

Posjetite www.support.google.com/androidtv za više informacija o tim postavkama.

Za otvaranje postavki...

- 1 - Pritisnite , odaberite Sve postavke i pritisnite OK.
- 2 - Odaberite Postavke za Android.
- 3 - Istražite različite postavke za Android.
- 4 - Pritisnite BACK, ako je potrebno, kako biste zatvorili izbornik.

7.5

Izbornik Početak

O izborniku Početak

Kako biste uživali u prednostima koje pruža Android TV, povežite televizor s internetom.

Kao i na Android pametnom telefonu ili tabletu, izbornik Početak predstavlja središte televizora. Iz izbornika Početak možete pokrenuti bilo koju

aplikaciju, promijeniti televizijski kanal, posuditi film, otvoriti web-mjesto ili prijeći na povezani uređaj. Ovisno o postavkama televizora i vašoj državi, izbornik Početak može sadržavati različite stavke.

Izbornik Početak organiziran je po recima...

Preporuke

Prvi redak sadrži preporuke za popularne videozapise, glazbene spotove ili internetske hitove. Možete postaviti postavke privatnosti u Odredbama uporabe kako biste omogućili prijedloge utemeljene na osobnim navikama gledanja.

Philips kolekcija

Ovaj red sadrži prijedloge iz Aplikacija.

Aplikacije

Redak s aplikacijama sadrži sve aplikacije koje se isporučuju s televizorom i aplikacije koje ste preuzeli iz trgovine Google Play Store. U ovom retku pronaći ćete i aplikacije za televizor kao što su Gledanje TV-a, Izvori, Mediji i druge. Aplikacije koje ste nedavno pokrenuli prikazat će se na početku retka.

Igre

Odavde možete pokrenuti igru na televizoru. Ako preuzmete igru, prikazat će se u ovom retku.

Postavke

Odavde možete otvoriti postavke. Međutim, kako biste pronašli sve postavke, pritisnite i odaberite Sve postavke. Ovdje možete i otvoriti izbornik Pomoć.

Također pogledajte

www.support.google.com/androidtv

Otvaranje izbornika Početak

Otvaranje izbornika Početak i zatim određene stavke...

- 1 - Pritisnite HOME.
- 2 - Odaberite stavku i pritisnite OK kako biste je otvorili ili pokrenuli.
- 3 - Pritisnite BACK kako biste zatvorili izbornik Početak bez pokretanja stavki.

Pretraživanje i glasovno pretraživanje

Možete pretraživati videozapise, glazbu ili bilo što drugo na internetu pomoću ikone u izborniku Početak. Možete izgovoriti ili napisati ono što tražite.

Ograničeni profil

Možete ograničiti upotrebu određenih aplikacija ako postavite televizor na ograničeni profil. Ograničeni profil dopušta upotrebu samo onih aplikacija koje ste odabrali. Taj profil možete uključiti samo pomoću PIN koda.

Kad je televizor postavljen na ograničeni profil, ne možete...

- pronaći ili otvoriti aplikacije označene kao Nedopušteno
- pristupiti trgovini Google Play
- kupovati sadržaje u trgovini Google Play Movies & TV niti Google Play Games
- upotrebljavati aplikacije drugih proizvođača koje ne koriste prijavu na Google

Kad je televizor postavljen na ograničeni profil, možete...

- gledati sadržaj koji je već posuđen ili kupljen u trgovini Google Play Movies & TV
- igrati igre koje su već kupljene i instalirane u trgovini Google Play Games
- pristupiti sljedećim postavkama: Wi-Fi mreža, Govor i pristupačnost
- dodati Bluetooth dodatke

Google račun na televizoru ostat će prijavljen. Upotrebom ograničenog profila ne mijenja se Google račun.

Aplikacije

8.1

Više o aplikacijama

Sve instalirane aplikacije možete pronaći u odjeljku  Aplikacije u izborniku Početak.

Kao aplikacije na pametnom telefonu ili tabletu, aplikacije na televizoru nude specifične funkcije koje obogaćuju doživljaj gledanja televizije. Primjerice aplikacije kao što su YouTube, igre, trgovine videosadržaja ili vremenske prognoze. Možete koristiti aplikaciju Internet za pretraživanje interneta.

Aplikacije mogu biti iz Galerije aplikacija tvrtke Philips ili trgovine Google Play™. Kako biste lakše započeli uporabu televizora, na njemu su instalirane neke praktične aplikacije.

Kako biste instalirali aplikacije iz Galerije aplikacija tvrtke Philips ili trgovine Google Play, televizor mora biti povezan s internetom. Morate prihvatiti odredbe uporabe kako biste mogli koristiti aplikacije iz galerije aplikacija. Morate se prijaviti s Google računom da biste mogli koristiti aplikacije usluge Google Play i trgovinu Google Play.

8.2

Google Play



Filmovi i televizijski program

Uz Google Play Movies & TV možete posuditi ili kupiti filmove ili televizijske emisije za gledanje na televizoru.



Što je potrebno

- televizor mora biti povezan s internetom
- morate se prijaviti sa svojim Google računom na televizoru
- dodajte svom Google računu kreditnu karticu kako biste mogli kupovati filmove i televizijske emisije





Za posuđivanje ili kupnju filma ili televizijske emisije...

- 1 - Pritisnite  HOME.
- 2 - Pomaknite se prema dolje i odaberite  Aplikacije > Google Play Movies & TV i pritisnite OK.
- 3 - Odaberite film ili televizijsku emisiju i pritisnite OK.
- 4 - Odaberite željenu stavku za kupnju i pritisnite OK. Proći ćete kroz postupak kupnje.

Za gledanje posuđenog ili kupljenog filma ili televizijske emisije...

- 1 - Pritisnite  HOME.
- 2 - Pomaknite se prema dolje i odaberite  Aplikacije > Google Play Movies & TV i pritisnite OK.

3 - Odaberite film ili televizijsku emisiju iz biblioteke u aplikaciji, odaberite naslov i pritisnite OK.

4 - Možete koristiti tipke  (zaustavljanje),  (pauza),  (premotavanje) ili  (brzo premotavanje naprijed) na daljinskom upravljaču.

5 - Za zaustavljanje aplikacije Movies & TV više puta pritisnite  BACK ili pritisnite  EXIT.

Neki proizvodi i značajke usluge Google Play nisu dostupni u svim zemljama.

Više informacija potražite na support.google.com/androidtv

Glazba





Uz Google Play Music možete reproducirati svoju omiljenu glazbu na televizoru.

Uz Google Play Music možete kupiti novu glazbu na svom računalo ili mobilnom uređaju. Umjesto toga, na svom se televizoru možete prijaviti za uslugu All Access, pretplatu na Google Play Music. Možete i reproducirati glazbu koja je već pohranjena na vašem računalo.

Što je potrebno

- televizor mora biti povezan s internetom
- morate se prijaviti sa svojim Google računom na televizoru
- dodajte svom Google računu kreditnu karticu kako biste se mogli pretplatiti na glazbu

Za pokretanje usluge Google Play Music...

- 1 - Pritisnite  HOME.
- 2 - Pomaknite se prema dolje i odaberite  Aplikacije > Google Play Music i pritisnite OK.
- 3 - Odaberite željenu glazbu i pritisnite OK.
- 4 - Za zaustavljanje aplikacije Music više puta pritisnite  BACK ili pritisnite  EXIT.

Neki proizvodi i značajke usluge Google Play nisu dostupni u svim zemljama.

Više informacija potražite na support.google.com/androidtv

Igre

Uz Google Play Games možete igrati igre na televizoru. Na mreži ili izvan mreže.

Možete vidjeti što vaši prijatelji trenutno igraju ili se uključiti u igru i natjecati se s njima. Možete pratiti svoja postignuća ili nastaviti gdje ste stali.





Što je potrebno

- televizor mora biti povezan s internetom
- morate se prijaviti sa svojim Google računom na televizoru

• dodajte svom Google računu kreditnu karticu kako biste mogli kupovati nove igre

Pokrenite aplikaciju Google Play Games kako biste odabrali i instalirali nove igre na svom televizoru. Neke igre su besplatne. Ako je za određenu igru potreban upravljač, prikazat će se poruka.

Za pokretanje ili zaustavljanje igre aplikacije Google Play Game...

- 1 - Pritisnite  HOME.
- 2 - Pomaknite se prema dolje i odaberite  Aplikacije > Google Play Games i pritisnite OK.
- 3 - Odaberite igru za igranje ili odaberite novu igru za instalaciju i pritisnite OK.
- 4 - Kad završite, više puta pritisnite  BACK ili pritisnite  EXIT ili zaustavite aplikaciju pomoću njezine namjenske tipke za izlaz/zaustavljanje.

Igre koje instalirate također će se prikazati u retku  Igre u izborniku Početak

Neki proizvodi i značajke usluge Google Play nisu dostupni u svim zemljama.

Više informacija potražite na support.google.com/androidtv





Trgovina Google Play

U trgovini Google Play možete preuzeti i instalirati nove aplikacije. Neke aplikacije su besplatne.

Što je potrebno

- televizor mora biti povezan s internetom
- morate se prijaviti sa svojim Google računom na televizoru
- dodajte svom Google računu kreditnu karticu kako biste mogli kupovati aplikacije



Za instalaciju nove aplikacije...

- 1 - Pritisnite  HOME.
- 2 - Pomaknite se prema dolje i odaberite  Aplikacije > Google Play Store i pritisnite OK.
- 3 - Odaberite aplikaciju koju želite instalirati i pritisnite OK.
- 4 - Za zatvaranje aplikacije Google Play Store više puta pritisnite  BACK ili pritisnite  EXIT.

Roditeljski nadzor

U trgovini Google Play možete sakriti aplikacije ovisno o dobi korisnika/kupaca. Morate unijeti PIN kôd da biste odabrali ili promijenili dob.

Za postavljanje roditeljske kontrole...

- 1 - Pritisnite  HOME.
- 2 - Pomaknite se prema dolje i odaberite  Aplikacije > Google Play Store i pritisnite OK.
- 3 - Odaberite Postavke > Roditeljski nadzor.
- 4 - Odaberite željenu dob.
- 5 - Na zahtjev unesite PIN kod.
- 6 - Za zatvaranje aplikacije Google Play Store više

puta pritisnite  BACK ili pritisnite  EXIT.

Neki proizvodi i značajke usluge Google Play nisu dostupni u svim zemljama.

Više informacija potražite na support.google.com/androidtv

Plaćanja

Za plaćanja na usluzi Google Play na televizoru morate svom Google računu dodati oblik plaćanja (ako ste izvan SAD-a, kreditnu karticu). Kad kupite film ili televizijsku emisiju, oni će se naplatiti putem kreditne kartice.

Za dodavanje kreditne kartice...





- 1 - Na računalu posjetite accounts.google.com i prijavite se s Google računom koji ćete koristiti za uslugu Google Play na televizoru.
- 2 - Posjetite wallet.google.com da biste dodali kreditnu karticu svom Google računu.
- 3 - Unesite podatke o kreditnoj kartici i prihvatite uvjete.

8.3

Pokretanje ili zaustavljanje aplikacije

Aplikaciju možete pokrenuti s izbornika Početak.

Za pokretanje aplikacije...

- 1 - Pritisnite  HOME.
- 2 - Pomaknite se prema dolje do  Aplikacije i odaberite željenu aplikaciju te pritisnite OK.
- 3 - Za zaustavljanje aplikacije pritisnite  BACK ili pritisnite  EXIT ili zaustavite aplikaciju pomoću njezine namjenske tipke za izlaz/zaustavljanje.

8.4

Blokada aplikacija

O blokadama aplikacija

Možete blokirati aplikacije koje nisu namijenjene djeci. Možete blokirati aplikacije iz galerije aplikacija namijenjene osobama starijima od 18 godina ili postaviti ograničeni profil u izborniku Početak.

18+

Blokada aplikacije 18+ tražit će PIN kod kad pokušate pokrenuti aplikaciju namijenjenu osobama starijima od 18 godina. Ta blokada vrijedi samo za aplikacije namijenjene osobama starijima od 18 godina iz galerije aplikacija tvrtke Philips.

Ograničeni profil

Možete postaviti ograničeni profil za izbornik Početak, u kojemu će biti dostupne samo aplikacije koje dopustite. Morate unijeti PIN kôd za postavljanje i uključivanje ograničenog profila.

Trgovina Google Play – dob



U trgovini Google Play možete sakriti aplikacije ovisno o dobi korisnika/kupaca. Morate unijeti PIN kôd da biste odabrali ili promijenili dob. Dob određuje koje su aplikacije dostupne za instalaciju.

Kako biste pronašli više informacija, u izborniku **Pomoć** odaberite **Ključne riječi** i potražite **Google Play Store**.

Zaključavanje aplikacija namijenjenih osobama starijima od 18 godina

Možete zaključati aplikacije namijenjene osobama starijima od 18 godina iz galerije aplikacija tvrtke Philips. Ova postavka kontrolira postavku 18+ u postavkama privatnosti galerije aplikacija tvrtke Philips.

Za zaključavanje aplikacija namijenjenih osobama starijima od 18 godina...

- 1 - Pritisnite , odaberite **Sve postavke** i pritisnite **OK**.
- 2 - Odaberite **Blokada uređaja**, a potom odaberite **Zaključavanje aplikacije**.
- 3 - Odaberite **Uključeno**.
- 4 - Po potrebi više puta pritisnite  (lijevo) kako biste zatvorili izbornik.

Ograničeni profil

O ograničenom profilu

Možete ograničiti upotrebu određenih aplikacija ako postavite televizor na ograničeni profil. U izborniku Početak prikazivat će se samo aplikacije koje ste dopustili. Za isključivanje ograničenog profila potreban vam je PIN kôd.

Kad je televizor postavljen na ograničeni profil, ne možete...

- pronaći ili otvoriti aplikacije označene kao **Nedopušteno**
- pristupiti trgovini Google Play
- kupovati sadržaje u trgovini Google Play Movies & TV niti Google Play Games
- upotrebljavati aplikacije drugih proizvođača koje ne koriste prijavu na Google





Kad je televizor postavljen na ograničeni profil, možete...

- gledati sadržaj koji je već posuđen ili kupljen u trgovini Google Play Movies & TV
- igrati igre koje su već kupljene i instalirane u trgovini Google Play Games
- pristupiti sljedećim postavkama: Wi-Fi mreža, Govor i pristupačnost
- dodati Bluetooth dodatke

Google račun na televizoru ostat će prijavljen. Upotrebom ograničenog profila ne mijenja se Google račun.

Postavljanje

Za postavljanje ograničenog profila...





- 1 - Pritisnite , odaberite **Sve postavke** i pritisnite **OK**.
- 2 - Odaberite **Postavke za Android** i pritisnite **OK**.
- 3 - Pritisnite  (dolje) i odaberite **Osobno > Sigurnost i ograničenja** i pritisnite **OK**.
- 4 - Odaberite **Ograničeni profil** i pritisnite **OK**.
- 5 - Odaberite **Postavke** i pritisnite **OK**.
- 6 - Unesite PIN kôd pomoću daljinskog upravljača.
- 7 - Odaberite **Dopuštene aplikacije** i pritisnite **OK**.
- 8 - Na popisu dostupnih aplikacija odaberite aplikaciju i pritisnite **OK** kako biste odabrali hoćete li je dopustiti.
- 9 - Pritisnite  **BACK** za vraćanje jedan korak ili pritisnite  **EXIT** za zatvaranje izbornika.

Sad možete ući u ograničeni profil.

Ako imate PIN kôd, uvijek ga možete promijeniti ili urediti popis dopuštenih i nedopuštenih aplikacija.

Ulaz



Za ulaz u (prebacivanje na) ograničeni profil...

- 1 - Pritisnite , odaberite **Sve postavke** i pritisnite **OK**.
- 2 - Odaberite **Postavke za Android** i pritisnite **OK**.
- 3 - Pritisnite  (dolje) i odaberite **Osobno > Sigurnost i ograničenja** i pritisnite **OK**.
- 4 - Odaberite **Ulaz u ograničeni profil** i pritisnite **OK**.
- 5 - Unesite PIN kôd pomoću daljinskog upravljača.
- 6 - Pritisnite  **BACK** za vraćanje jedan korak ili pritisnite  **EXIT** za zatvaranje izbornika.

Ulaz u ograničeni profil označen je ikonom u izborniku Početak. Pomaknite se prema dolje na  **Postavke** i pomaknite se do kraja udesno.

Izlaz

Za izlaz iz ograničenog profila...



- 1 - Pritisnite  HOME, pomaknite se prema dolje na  Postavke i pomaknite se do kraja udesno.
- 2 - Odaberite Ograničeni profil i pritisnite OK.
- 3 - Odaberite Izlaz iz ograničenog profila i pritisnite OK.
- 4 - Unesite PIN kôd. Televizor će izaći iz ograničenog profila.

8.5

Upravljanje aplikacijama

Ako zaustavite aplikaciju i vratite se na izbornik Početak, aplikacija se zapravo ne zaustavlja. Još uvijek radi u pozadini kako bi bila spremna kad je ponovno pokrenete. Većina aplikacija za neometan rad pohranjuje neke podatke u predmemoriju televizora. Bilo bi dobro potpuno zaustaviti aplikaciju ili izbrisati podatke predmemorije za određenu aplikaciju kako bi se optimizirao cjelokupni rad aplikacija i smanjila iskorištena memorija na Android TV-u. Također je najbolje deinstalirati aplikacije koje više ne koristite.

Za otvaranje popisa preuzetih aplikacija i aplikacija sustava...

- 1 - Pritisnite , odaberite Sve postavke i pritisnite OK.
- 2 - Odaberite Postavke za Android i pritisnite OK.
- 3 - Odaberite Uređaj > Aplikacije i pritisnite OK.
- 4 - Odaberite aplikaciju i pritisnite OK. Ako aplikacija još uvijek radi, možete je prisilno zaustaviti ili izbrisati podatke predmemorije. Možete deinstalirati aplikacije koje ste preuzeli.
- 5 - Pritisnite  BACK za vraćanje jedan korak ili pritisnite  EXIT za zatvaranje izbornika.

Ako koristite USB tvrdi disk za pohranu aplikacija, možete premjestiti aplikaciju s USB tvrdog diska u memoriju televizora i obratno.

8.6

Spremanje

Možete vidjeti koliko prostora za pohranu - interne memorije televizora - koristite za svoje aplikacije, videozapise, glazbu itd. Možete vidjeti koliko vam je slobodnog prostora preostalo za instaliranje novih aplikacija. Provjerite slobodni prostor ako aplikacija sporo radi ili ima problema.

Da biste vidjeli koliko prostora koristite...

- 1 - Pritisnite , odaberite Sve postavke i pritisnite OK.
- 2 - Odaberite Postavke za Android i pritisnite OK.

3 - Odaberite Uređaj > Pohrana i ponovno postavljanje i pritisnite OK.

4 - Pogledajte koliko prostora za pohranu memorije televizora koristite.

5 - Pritisnite  BACK za vraćanje jedan korak ili pritisnite  EXIT za zatvaranje izbornika.

USB tvrdi disk

Ako povežete USB tvrdi disk, možete ga koristiti za proširenje memorije televizora kako biste mogli pohraniti više aplikacija. Televizor će nove aplikacije prvo pokušati pohraniti na USB tvrdi disk. Neke aplikacije se ne mogu pohraniti na USB tvrdi disk.

Internet







9.1

Pokretanje interneta

Možete pretraživati internet na svom televizoru. Možete prikazati bilo koju internetsku stranicu, ali većina njih nije prilagođena prikazu na zaslonu televizora.

- Neki programski dodaci (npr. za prikaz stranica ili videozapisa) nisu dostupni za televizor.
- Ne možete slati niti preuzimati datoteke.
- Internetske stranice prikazuju se jedna po jedna i preko cijelog zaslona.

Za pokretanje internetskog preglednika...



- 1 - Pritisnite  HOME.
- 2 - Pomaknite se prema dolje i odaberite Aplikacije >  Internet i pritisnite  OK.
- 3 - Unesite internetsku adresu i odaberite , pritisnite  OK.
- 4 - Za zatvaranje interneta pritisnite  HOME ili  EXIT.

9.2

Opcije na internetu

Za internet su dostupne neke dodatne opcije.

Za otvaranje dodatnih opcija...

- 1 - Dok je internetska stranica otvorena, pritisnite  OPTIONS.
- 2 - Odaberite jednu od stavki i pritisnite  OK.
- 3 - Po potrebi više puta pritisnite  (lijevo) kako biste zatvorili izbornik.

Unesite adresu

Za unos nove internetske adrese.

Prikaži omiljene

Za prikaz stranica koje ste označili kao omiljene.

Ponovno učitavanje stranice

Za ponovno učitavanje internetske stranice.

Zumiranje stranice

Pomoću klizne trake postavite postotak zumiranja.

Sigurnosne informacije

Za prikaz razine sigurnosti trenutne stranice.

Označi kao omiljeno

Za označavanje trenutne stranice kao omiljene.

Titlovi

Izbornik televizora



O izborniku televizora

Ako se televizor ne može povezati s internetom, možete upotrijebiti **Izbornik televizora** kao svoj početni izbornik.

U izborniku televizora pronaći ćete sve funkcije televizora.

Otvaranje izbornika televizora

Za otvaranje izbornika televizora i zatim određene stavke...

- 1 - Pritisnite  za otvaranje izbornika televizora.
- 2 - Odaberite stavku i pritisnite **OK** kako biste je otvorili ili pokrenuli.
- 3 - Pritisnite  **BACK** kako biste zatvorili izbornik televizora bez pokretanja stavki.

Izvori

11.1

Prelazak na uređaj

Na popisu Izvori možete odabrati bilo koji od povezanih uređaja. Možete odabrati tuner za gledanje televizijskog programa, otvoriti sadržaj povezanog USB flash diska ili pregledati snimke na povezanom USB tvrdom disku. Možete prijeći na povezane uređaje za prikaz programa, digitalni prijemnik ili Blu-ray Disc reproduktor.

Prelazak na povezani uređaj...

- 1 - Pritisnite **SOURCES** kako biste otvorili izbornik Izvori.
- 2 - Odaberite stavku s popisa izvora i pritisnite **OK**. Televizor će prikazati program ili sadržaj uređaja.
- 3 - Ponovno pritisnite **SOURCES** za zatvaranje izbornika.

Reprodukcija jednim dodirrom

Dok je televizor u stanju pripravnosti, možete prijeći na reproduktor diskova pomoću daljinskog upravljača televizora.

Kako biste i reproduktor i televizor aktivirali iz stanja pripravnosti i odmah započeli reprodukciju diska, pritisnite **▶** (reprodukcija) na daljinskom upravljaču televizora. Uređaj mora biti povezan pomoću HDMI kabela, a opcija HDMI CEC mora biti uključena i na televizoru i na uređaju.

11.2

Opcije TV ulaza

Neki uređaji za TV ulaz nude posebne postavke.

Za postavljanje opcija za određeni TV ulaz...

- 1 - Pritisnite **SOURCES**.
- 2 - Odaberite TV ulaz na popisu i pritisnite **OK**.
- 3 - Pritisnite **+ OPTIONS**. Ovdje možete postaviti opcije za odabrani TV ulaz.
- 4 - Ponovno pritisnite **+ OPTIONS** za zatvaranje izbornika Opcije.

Moguće opcije...

Kontrole

Putem ove opcije možete upravljati povezanim uređajem pomoću daljinskog upravljača televizora. Uređaj mora biti povezan pomoću HDMI kabela, a opcija HDMI CEC mora biti uključena i na televizoru i na uređaju.

Informacije o uređaju

Otvorite ovu opciju za prikaz informacija o

povezanom uređaju.

11.3

Naziv i vrsta uređaja

Kad povežete novi uređaj s televizorom i on ga prepozna, možete dodijeliti ikonu za tu vrstu uređaja. Ako povežete uređaj koristeći HDMI kabel i HDMI CEC, televizor će automatski prepoznati vrstu uređaja i uređaj će dobiti odgovarajuću ikonu.

Vrstom uređaja određuju se stilovi slike i zvuka, vrijednosti rezolucije, određene postavke ili položaj u izborniku Izvori. Ne morate se brinuti o idealnim postavkama.

Preimenovanje ili promjena vrste

Uvijek možete promijeniti naziv ili vrstu povezanog uređaja. Potražite ikonu **+** desno od naziva uređaja u izborniku Izvori. Neki izvori TV ulaza ne dopuštaju promjenu naziva.

Za promjenu vrste uređaja...

- 1 - Odaberite uređaj u izborniku Izvori.
- 2 - Pritisnite **+ OPTIONS**.
- 3 - Pritisnite **← BACK** za skrivanje zaslonske tipkovnice.
- 4 - Pritisnite **▼** (dolje) kako biste pronašli sve dostupne vrste uređaja. Odaberite željenu vrstu i pritisnite **OK**.

5 - Ako želite ponovno postaviti vrstu uređaja na izvornu vrstu priključnice, odaberite **Ponovno postavi** i pritisnite **OK**.

6 - Odaberite **Zatvori** i pritisnite **OK** kako biste zatvorili izbornik.



Za promjenu naziva uređaja...

- 1 - Odaberite uređaj u izborniku Izvori.
- 2 - Pritisnite **+ OPTIONS**.
- 3 - Pritisnite **← BACK** za skrivanje zaslonske tipkovnice.
- 4 - Pomoću tipkovnice na stražnjoj strani daljinskog upravljača izbrišite trenutni naziv i unesite novi.
- 5 - Ako želite ponovno postaviti naziv uređaja na izvorni naziv priključnice, odaberite **Ponovno postavi** i pritisnite **OK**.
- 6 - Odaberite **Zatvori** i pritisnite **OK** kako biste zatvorili izbornik.

Računalo

Ako povežete računalo, savjetujemo vam da vezi putem koje je računalo povezano dodate ispravan naziv vrste uređaja u izborniku Izvori. Ako zatim u izborniku Izvori promijenite postavku na Računalo, televizor će se automatski postaviti na idealnu postavku za računalo.

Za postavljanje televizora na idealnu postavku...

- 1 - Pritisnite , odaberite Sve postavke i pritisnite OK.
- 2 - Odaberite Slika i pritisnite  (desno) kako biste otvorili izbornik.
- 3 - Odaberite Napredno > Računalo.
- 4 - Odaberite Uključeno ili Isključeno.
- 5 - Po potrebi više puta pritisnite  (lijevo) kako biste zatvorili izbornik.



Postavke

12.1

Česte postavke

Najčešće korištene postavke možete pronaći u izborniku °Česte postavke.

Otvaranje izbornika...

- 1 - Pritisnite .
- 2 - Odaberite postavku koju želite podesiti i pritisnite °OK.
- 3 - Ako ne želite promijeniti ništa, pritisnite  BACK.



12.2

Slika

Stil slike

Odabir stila

Radi jednostavne prilagodbe slike, možete odabrati prethodno postavljenu postavku za Stil slike.

- 1 - Dok gledate televizijski kanal, pritisnite .
- 2 - Odaberite **Stil slike** i zatim jedan od stilova na popisu.
- 3 - Po potrebi više puta pritisnite  (lijevo) kako biste zatvorili izbornik.

Dostupni stilovi...

- **Osobna** – preference slike koje postavite tijekom prvog pokretanja.
- **Živo** – idealno za gledanje tijekom dana
- **Prirodno** – postavke za prirodnu sliku
- **Standardno** – energetska najučinkovitija postavka, zadana
- **Film** – idealno za gledanje filmova

- **Fotografije** – idealno za prikaz fotografija

- **Igre** – idealno za igranje

Prilagodba stila

Sve odabrane postavke slike, npr. Boja ili Kontrast, spremaju se u trenutačno odabrani **Stil slike**. Stilove možete prilagođavati.

Samo za stil **Osobna** možete spremati postavke za svaki izvor u izborniku Izvori.



Vraćanje stila

Dok je stil slike odabran, bilo koju postavku slike možete prilagoditi tako da odaberete **Sve postavke** > **Slika**...

Odabrani stil spremat će unesene promjene.

Preporučujemo prilagodbu postavki slike samo za stil **Osobna**. Stil slike – Osobna može spremati svoje postavke za svaki pojedinačni izvor u izborniku Izvori.



Vraćanje stila na zadane postavke...

- 1 - Dok gledate televizijski kanal, pritisnite .
- 2 - Odaberite **Stil slike** i zatim stil slike koji želite vratiti.
- 3 - Odaberite **Ponovo postavi stil** i pritisnite **OK**. Stil će se vratiti.
- 4 - Po potrebi više puta pritisnite  (lijevo) kako biste zatvorili izbornik.

Dom ili trgovina

Ako se **stil slike** vraća na **Živo** svaki put kada uključite televizor, opcija lokacije na televizoru postavljena je na **Trgovina**. To je postavka za promociju u trgovini.

Postavljanje televizora za upotrebu kod kuće...







- 1 - Pritisnite , odaberite **Sve postavke** i pritisnite **OK**.
- 2 - Odaberite **Općenite postavke** i pritisnite  (desno) kako biste otvorili izbornik.
- 3 - Odaberite **Mjesto** > **Dom**.
- 4 - Po potrebi više puta pritisnite  (lijevo) kako biste zatvorili izbornik.

Postavke slike

Boja

Opcija **Boja** omogućava prilagodbu zasićenosti boje slike.

Prilagodba boje...

- 1 - Pritisnite , odaberite **Sve postavke** i pritisnite **OK**.
- 2 - Odaberite **Slika** i pritisnite  (desno) kako biste otvorili izbornik.
- 3 - Odaberite **Boja** i pritisnite  (desno).
- 4 - Pritisnite strelice  (gore) ili  (dolje) kako biste prilagodili vrijednost.
- 5 - Po potrebi više puta pritisnite  (lijevo) kako biste zatvorili izbornik.

Kontrast

Opcija **Kontrast** omogućava prilagodbu kontrasta slike.

Prilagodba kontrasta...

- 1 - Pritisnite , odaberite **Sve postavke** i pritisnite **OK**.
- 2 - Odaberite **Slika** i pritisnite **➤** (desno) kako biste otvorili izbornik.
- 3 - Odaberite **Kontrast** i pritisnite **➤** (desno).
- 4 - Pritisnite strelice **▲** (gore) ili **▼** (dolje) kako biste prilagodili vrijednost.
- 5 - Po potrebi više puta pritisnite **◀** (lijevo) kako biste zatvorili izbornik.

Oštrina

Opcija **Oštrina** omogućava prilagodbu razine oštine u detaljima slike.

Prilagodba oštine...

- 1 - Pritisnite , odaberite **Sve postavke** i pritisnite **OK**.
- 2 - Odaberite **Slika** i pritisnite **➤** (desno) kako biste otvorili izbornik.
- 3 - Odaberite **Oštrina** i pritisnite **➤** (desno).
- 4 - Pritisnite strelice **▲** (gore) ili **▼** (dolje) kako biste prilagodili vrijednost.
- 5 - Po potrebi više puta pritisnite **◀** (lijevo) kako biste zatvorili izbornik.

Svjetlina

Opcija **Svjetlina** omogućava postavljanje razine svjetline slike.

Prilagodba oštine...

- 1 - Pritisnite , odaberite **Sve postavke** i pritisnite **OK**.
- 2 - Odaberite **Slika** i pritisnite **➤** (desno) kako biste otvorili izbornik.
- 3 - Odaberite **Svjetlina** i pritisnite **➤** (desno).
- 4 - Pritisnite strelice **▲** (gore) ili **▼** (dolje) kako biste prilagodili vrijednost.
- 5 - Po potrebi više puta pritisnite **◀** (lijevo) kako biste zatvorili izbornik.

Napredne postavke slike

Računalo

Ako povežete računalo, savjetujemo vam da vezi putem koje je računalo povezano dodate ispravan naziv vrste uređaja u izborniku Izvori. Ako zatim u izborniku Izvori promijenite postavku na **Računalo**, televizor će se automatski postaviti na idealnu

postavku za računalo.

Za postavljanje televizora na idealnu postavku...

- 1 - Pritisnite , odaberite **Sve postavke** i pritisnite **OK**.
- 2 - Odaberite **Slika** i pritisnite **➤** (desno) kako biste otvorili izbornik.
- 3 - Odaberite **Napredno > Računalo**.
- 4 - Odaberite **Uključeno** ili **Isključeno**.
- 5 - Po potrebi više puta pritisnite **◀** (lijevo) kako biste zatvorili izbornik.

Postavke boja

Naglašavanje boje

Opcija **Naglašavanje boje** omogućava poboljšanje intenziteta boje i pojedinosti u jarkim bojama.

Prilagodba razine...

- 1 - Pritisnite , odaberite **Sve postavke** i pritisnite **OK**.
- 2 - Odaberite **Slika** i pritisnite **➤** (desno) kako biste otvorili izbornik.
- 3 - Odaberite **Napredno > Boja > Naglašavanje boje**.
- 4 - Odaberite **Maksimalna**, **Srednja**, **Minimalna** ili **Isključeno**.
- 5 - Po potrebi više puta pritisnite **◀** (lijevo) kako biste zatvorili izbornik.

Temperatura boja

Opcija **Temperatura boje** omogućava postavljanje slike na zadanu temperaturu boje ili odabir opcije **Prilagođeno** koja vam omogućava da sami odaberete postavku temperature pomoću opcije **Prilagođena temperatura boje**. Postavke **Temperatura boje** i **Prilagođena temperatura boje** postavke su namijenjene naprednim korisnicima.





Odabir zadane postavke...

- 1 - Pritisnite , odaberite **Sve postavke** i pritisnite **OK**.
- 2 - Odaberite **Slika** i pritisnite **➤** (desno) kako biste otvorili izbornik.
- 3 - Odaberite **Napredno > Boja > Temperatura boja**.
- 4 - Odaberite **Normalna**, **Topla** ili **Hladna**. Možete odabrati i **Prilagođeno** ako želite sami prilagoditi temperaturu boje.
- 5 - Po potrebi više puta pritisnite **◀** (lijevo) kako biste zatvorili izbornik.

Prilagođena temperatura boje

Opcija **Prilagođena temperatura boje** omogućava vam da sami postavite temperaturu boje. Kako biste postavili prilagođenu temperaturu boje, najprije odaberite **Prilagođeno** u izborniku **Temperatura boje**. Postavka **Prilagođena temperatura boje** namijenjena je naprednim korisnicima.

Postavljanje prilagođene temperature boje...



- 1 - Pritisnite , odaberite **Sve postavke** i pritisnite **OK**.
- 2 - Odaberite **Slika** i pritisnite  (desno) kako biste otvorili izbornik.
- 3 - Odaberite **Napredno > Boja > Prilagođena temperatura boje**.
- 4 - Pritisnite strelice  (gore) ili  (dolje) kako biste prilagodili vrijednost. WP je postavka bijele, a BL razina crne. Možete i odabrati neku od zadanih postavki u ovom izborniku.
- 5 - Po potrebi više puta pritisnite  (lijevo) kako biste zatvorili izbornik.

Postavke kontrasta

Načini rada kontrasta

Opcija **Način rada kontrasta** omogućava postavljanje razine na kojoj se potrošnja energije može smanjiti prigušivanjem intenziteta osvjetljenja zaslona. Odaberite najmanju potrošnju energije ili sliku s najboljim intenzitetom.



Prilagodba razine...

- 1 - Pritisnite , odaberite **Sve postavke** i pritisnite **OK**.
- 2 - Odaberite **Slika** i pritisnite  (desno) kako biste otvorili izbornik.
- 3 - Odaberite **Napredno > Kontrast > Način rada kontrasta**.
- 4 - Odaberite **Standardno**, **Najbolja iskoristivost energije**, **Najbolja slika** ili **Isključeno**.
- 5 - Po potrebi više puta pritisnite  (lijevo) kako biste zatvorili izbornik.

Dinamički kontrast

Opcija **Dinamički kontrast** omogućava postavljanje razine na kojoj televizor automatski naglašava detalje na crnim, srednjim i svijetlim područjima slike.

Prilagodba razine...

- 1 - Pritisnite , odaberite **Sve postavke** i pritisnite **OK**.
- 2 - Odaberite **Slika** i pritisnite  (desno) kako biste otvorili izbornik.
- 3 - Odaberite **Napredno > Kontrast > Dinamički kontrast**.

4





- Odaberite **Maksimalna**, **Srednja**, **Minimalna** ili **Isključeno**.

5 - Po potrebi više puta pritisnite  (lijevo) kako biste zatvorili izbornik.

Kontrast videozapisa

Opcija **Kontrast videozapisa** omogućava smanjenje raspona kontrasta videozapisa.





Prilagodba razine...

- 1 - Pritisnite , odaberite **Sve postavke** i pritisnite **OK**.
- 2 - Odaberite **Slika** i pritisnite  (desno) kako biste otvorili izbornik.
- 3 - Odaberite **Napredno > Kontrast > Kontrast videozapisa**.
- 4 - Pritisnite strelice  (gore) ili  (dolje) kako biste prilagodili vrijednost.
- 5 - Po potrebi više puta pritisnite  (lijevo) kako biste zatvorili izbornik.

Gama

Opcija **Gama** omogućava postavljanje nelinearne postavke za svjetlinu i kontrast slike. Gama je postavka namijenjena naprednim korisnicima.

Prilagodba razine...



- 1 - Pritisnite , odaberite **Sve postavke** i pritisnite **OK**.
- 2 - Odaberite **Slika** i pritisnite  (desno) kako biste otvorili izbornik.
- 3 - Odaberite **Napredno > Kontrast > Gama**.
- 4 - Pritisnite strelice  (gore) ili  (dolje) kako biste prilagodili vrijednost.
- 5 - Po potrebi više puta pritisnite  (lijevo) kako biste zatvorili izbornik.

Postavke oštine

Super Resolution

Opcija **Super Resolution** omogućava superiornu oštrinu rubova i kontura slike.

Uključivanje ili isključivanje...

- 1 - Pritisnite , odaberite **Sve postavke** i pritisnite **OK**.
- 2 - Odaberite **Slika** i pritisnite  (desno) kako biste otvorili izbornik.
- 3 - Odaberite **Napredno > Oština > Super Resolution**.
- 4 - Odaberite **Uključeno** ili **Isključeno**.
- 5 - Po potrebi više puta pritisnite  (lijevo) kako biste zatvorili izbornik.

Smanjenje šuma

Opcija **Smanjenje šuma** omogućava filtriranje i smanjenje razine šuma na slici.

Prilagodba smanjenja šuma...

- 1 - Pritisnite , odaberite **Sve postavke** i pritisnite **OK**.
- 2 - Odaberite **Slika** i pritisnite **➤** (desno) kako biste otvorili izbornik.
- 3 - Odaberite **Napredno > Oštrina > Smanjenje šuma**.
- 4
 - Odaberite **Maksimalna, Srednja, Minimalna** ili **Isključeno**.
- 5 - Po potrebi više puta pritisnite **◀** (lijevo) kako biste zatvorili izbornik.

MPEG smanjenje smetnji

Opcija **MPEG smanjenje smetnji** omogućava ublažavanje prijelaza na digitalnoj slici. MPEG smetnje uglavnom su vidljive kao mali kvadratići ili neravni rubovi na slici.

Kako biste smanjili MPEG smetnje...



- 1 - Pritisnite , odaberite **Sve postavke** i pritisnite **OK**.
- 2 - Odaberite **Slika** i pritisnite **➤** (desno) kako biste otvorili izbornik.
- 3 - Odaberite **Napredno > Oštrina > MPEG smanjenje smetnji**.
- 4
 - Odaberite **Maksimalna, Srednja, Minimalna** ili **Isključeno**.
- 5 - Po potrebi više puta pritisnite **◀** (lijevo) kako biste zatvorili izbornik.

Format slike

Osnovno

Ako slika ne ispunjava cijeli zaslon, ako se na vrhu i dnu zaslona ili na bočnim stranama prikazuju crne trake, možete prilagoditi sliku tako da ispunji cijeli zaslon.

Odabir neke od osnovnih postavki za ispunjavanje zaslona...

- 1 - Dok gledate televizijski kanal, pritisnite  (ako je tipka dostupna na daljinskom upravljaču) ili pritisnite .
- 2 - Odaberite **Format slike > Ispuni zaslon, Prilagodi zaslonu** ili **Široki zaslon**.
- 3 - Po potrebi više puta pritisnite **◀** (lijevo) kako biste zatvorili izbornik.
 - Opcija **Ispuni zaslon** – automatski povećava sliku kako bi ispunila zaslon. Izobličenje slike je minimalno,

titlovi su vidljivi. Nije pogodno za prikaz slike s osobnog računala. Neki vrlo veliki formati slike mogu i dalje imati crne trake.



- Opcija **Prilagodi zaslonu** – automatski zumira sliku kako bi ispunila što veći dio zaslona bez izobličenja. Mogu se vidjeti crne trake. Nije pogodno za prikaz slike s osobnog računala.
- **Široki zaslon** – automatski povećava sliku na široki zaslon.

Napredno

Ako dvije osnovne postavke nisu dovoljne za formatiranje željene slike, možete upotrijebiti napredne postavke. Napredne postavke omogućavaju ručno formatiranje slike na zaslonu.

Sliku možete zumirati, proširivati i pomicati dok ne bude prikazivala ono što trebate – primjerice titlove koji nedostaju ili tekstne natpise kroz koje se može pomicati. Ako sliku formatirate za određeni izvor, primjerice povezanu igraću konzolu, na tu postavku možete se vratiti prilikom sljedeće uporabe igraće konzole. Televizor će pohraniti posljednju postavku koju ste postavili za svaku vezu.



Ručno formatiranje slike...

- 1 - Dok gledate televizijski kanal, pritisnite  (ako je tipka dostupna na daljinskom upravljaču) ili pritisnite .
- 2 - Odaberite **Napredno** i pritisnite **OK**.
- 3 - Koristite opcije **Pomakni, Zumiranje, Raširi** ili **Original** kako biste prilagodili sliku.
- 4 - Umjesto toga, možete odabrati i **Posljednja postavka** i pritisnuti **OK** za prelazak na prethodno spremljeni format.
- 5 - Možete odabrati i **Poništi** za povratak na postavku koju je slika imala kada ste otvorili **Format slike**.
 - **Pomakni** – odaberite strelice kako biste pomaknuli sliku. Sliku možete pomaknuti samo kada je povećana zumiranjem.
 - **Zumiranje** – odaberite strelice kako biste zumirali.
 - **Raširi** – odaberite strelice kako biste raširili sliku okomito ili vodoravno.
 - **Poništi** – odaberite za povratak na format slike s kojim ste započeli.
 - **Izvorni format** – prikazuje izvorni format ulazne slike. To je format 1:1 piksel na piksel. Profesionalni način rada za prikaz HD sadržaja ili slike s računala.

Brzo postavljanje slike

Tijekom prve instalacije izvršili ste neke postavke slike u nekoliko jednostavnih koraka. Te korake možete ponoviti pomoću opcije **Brzo postavljanje slike**. Kako biste izvršili te korake, provjerite možete li televizor prijeći na televizijski kanal ili prikazati program s povezanog uređaja.

Postavljanje slike u nekoliko jednostavnih koraka...

- 1 - Pritisnite , odaberite **Sve postavke** i pritisnite **OK**.
- 2 - Odaberite **Slika** i pritisnite  (desno) kako biste otvorili izbornik.
- 3 - Odaberite **Brzo postavljanje slike**.
- 4 - Odaberite **Pokreni**. Izvršite odabir pomoću tipki za navigaciju.
- 5 - Na kraju odaberite **Završi**.
- 6 - Po potrebi više puta pritisnite  (lijevo) kako biste zatvorili izbornik.



12.3

Zvuk

Stil zvuka

Odabir stila

Kako biste jednostavno prilagodili zvuk, možete odabrati prethodno postavljenu postavku pomoću opcije **Stil zvuka**.

- 1 - Dok gledate televizijski kanal, pritisnite .
- 2 - Odaberite **Zvuk** i pritisnite  (desno) kako biste otvorili izbornik.
- 3 - Odaberite **Stil zvuka** i zatim jedan od stilova na popisu.
- 4 - Po potrebi više puta pritisnite  (lijevo) kako biste zatvorili izbornik.

Dostupni stilovi...

- **Osobna** – preference zvuka koje postavite tijekom prvog pokretanja.
- **Original** – postavka najprirodnijeg zvuka
- **Film** – idealno za gledanje filmova
- **Glazba** – idealno za slušanje glazbe
- **Igre** – idealno za igranje

- **Vijesti** – idealno za reprodukciju govora



Vraćanje stila

Dok je stil zvuka odabran, bilo koju postavku zvuka možete prilagoditi tako da odaberete **Podešavanje > Zvuk...**

Odabrani stil spremiće unesene promjene. Preporučujemo prilagodbu postavki zvuka samo za

stil **Osobna**. Stil zvuka – Osobna može spremiće svoje postavke za svaki pojedinačni izvor u izborniku Izvori.

Vraćanje stila na zadane postavke...







- 1 - Dok gledate televizijski kanal, pritisnite .
- 2 - Odaberite **Zvuk** i pritisnite  (desno) kako biste otvorili izbornik.
- 3 - Odaberite **Stil zvuka** i zatim stil zvuka koji želite vratiti.
- 4 - Odaberite **Ponovo postavi stil**. Stil će se vratiti.
- 5 - Po potrebi više puta pritisnite  (lijevo) kako biste zatvorili izbornik.

Postavke zvuka

Bas

Opcija **Bas** omogućava prilagodbu razine niskih tonova u zvuku.







Prilagodba razine...

- 1 - Pritisnite , odaberite **Sve postavke** i pritisnite **OK**.
- 2 - Odaberite **Zvuk** i pritisnite  (desno) kako biste otvorili izbornik.
- 3 - Odaberite **Bas** i pritisnite .
- 4 - Pritisnite strelice  (gore) ili  (dolje) kako biste prilagodili vrijednost.
- 5 - Po potrebi više puta pritisnite  (lijevo) kako biste zatvorili izbornik.

Visoki tonovi

Opcija **Visoki tonovi** omogućava prilagodbu razine visokih tonova u zvuku.



Prilagodba razine...

- 1 - Pritisnite , odaberite **Sve postavke** i pritisnite **OK**.
- 2 - Odaberite **Zvuk** i pritisnite  (desno) kako biste otvorili izbornik.
- 3 - Odaberite **Visoki tonovi** i pritisnite .
- 4 - Pritisnite strelice  (gore) ili  (dolje) kako biste prilagodili vrijednost.
- 5 - Po potrebi više puta pritisnite  (lijevo) kako biste zatvorili izbornik.

Glasnoća slušalica

Opcija **Glasnoća slušalica** omogućava zasebno postavljanje glasnoće povezanih slušalica.

Prilagodba glasnoće...

- 1 - Pritisnite , odaberite **Sve postavke** i pritisnite **OK**.
- 2 - Odaberite **Zvuk** i pritisnite  (desno) kako biste otvorili izbornik.

- 3 - Odaberite **Glasnoća slušalica**.
- 4 - Pritisnite strelice **▲** (gore) ili **▼** (dolje) kako biste prilagodili vrijednost.
- 5 - Po potrebi više puta pritisnite **◀** (lijevo) kako biste zatvorili izbornik.

Glasnoća niskotonca

Ako povežete bežični Bluetooth niskotonac, možete malo povećati ili smanjiti glasnoću niskotonca.

Mala prilagodba glasnoće...

- 1 - Pritisnite **⚙️**, odaberite **Sve postavke** i pritisnite **OK**.
- 2 - Odaberite **Zvuk** i pritisnite **▶** (desno) kako biste otvorili izbornik.
- 3 - Odaberite **Glasnoća niskotonca**.
- 4 - Pritisnite **▲** (gore) ili **▼** (dolje) kako biste prilagodili vrijednost.
- 5 - Po potrebi više puta pritisnite **◀** (lijevo) kako biste zatvorili izbornik.

Surround načini rada

Opcija **Surround načini rada** omogućava postavljanje efekta zvuka zvučnika televizora.

Postavljanje surround načina rada...

- 1 - Pritisnite **⚙️**, odaberite **Sve postavke** i pritisnite **OK**.
- 2 - Odaberite **Zvuk** i pritisnite **▶** (desno) kako biste otvorili izbornik.
- 3 - Odaberite **Surround načini rada**.
- 4 - Odaberite **Stereo** ili **Incredible Surround**.
- 5 - Po potrebi više puta pritisnite **◀** (lijevo) kako biste zatvorili izbornik.

Smještaj televizora

U sklopu prve instalacije ova postavka postavljena je na opciju **Na stalku za televizor** ili **Na zidu**. Ako ste od tada promijenili položaj televizora, prilagodite ovu postavku za najbolju reprodukciju zvuka.

- 1 - Pritisnite **⚙️**, odaberite **Sve postavke** i pritisnite **OK**.
- 2 - Odaberite **Zvuk** i pritisnite **▶** (desno) kako biste otvorili izbornik.
- 3 - Odaberite **Smještaj televizora**.
- 4 - Odaberite **Na stalku za televizor** ili **Na zidu**.
- 5 - Po potrebi više puta pritisnite **◀** (lijevo) kako biste zatvorili izbornik.

Napredne postavke zvuka

Automatsko izjednačavanje glasnoće

Opcija **Automatsko izjednačavanje glasnoće** omogućava postavljanje televizora na automatsko izjednačavanje iznenadnih razlika u glasnoći. To je obično na početku reklama ili prilikom promjene kanala.

Uključivanje ili isključivanje...

- 1 - Pritisnite **⚙️**, odaberite **Sve postavke** i pritisnite **OK**.
- 2 - Odaberite **Zvuk** i pritisnite **▶** (desno) kako biste otvorili izbornik.
- 3 - Odaberite **Napredno** i pritisnite **▶** (desno) kako biste otvorili izbornik.
- 4 - Odaberite **Automatsko izjednačavanje glasnoće** i pritisnite **▶** (desno) kako biste otvorili izbornik.
- 5 - Odaberite **Uključeno** ili **Isključeno**.
- 6 - Po potrebi više puta pritisnite **◀** (lijevo) kako biste zatvorili izbornik.

Clear Sound

Opcija **Clear Sound** omogućava poboljšanje zvuka za govor. Idealna je za programe s vijestima. Poboljšanje zvuka govora možete uključiti ili isključiti.

Uključivanje ili isključivanje...

- 1 - Pritisnite **⚙️**, odaberite **Sve postavke** i pritisnite **OK**.
- 2 - Odaberite **Zvuk** i pritisnite **▶** (desno) kako biste otvorili izbornik.
- 3 - Odaberite **Napredno >** **Clear Sound**.
- 4 - Odaberite **Uključeno** ili **Isključeno**.
- 5 - Po potrebi više puta pritisnite **◀** (lijevo) kako biste zatvorili izbornik.

Format audio izlaza

Ako imate sustav kućnog kina (HTS) s mogućnošću obrade višekanalnog zvuka kao što je Dolby Digital, DTS® ili sličan, postavite Format audio izlaza na opciju **Višekanalno**. Opcija **Višekanalno** televizoru omogućava slanje komprimiranog višekanalnog zvučnog signala s televizijskog kanala ili povezanog reproduktora na sustav kućnog kina. Ako imate sustav kućnog kina bez mogućnosti obrade višekanalnog zvuka, odaberite **Stereo**.

Postavljanje formata audio izlaza...

- 1 - Pritisnite **⚙️**, odaberite **Sve postavke** i pritisnite **OK**.
- 2 - Odaberite **Zvuk** i pritisnite **▶** (desno) kako biste otvorili izbornik.
- 3 - Odaberite **Napredno >** **Format audio izlaza**.

- 4 - Odaberite **Višekanalno** ili **Stereo**.
- 5 - Po potrebi više puta pritisnite **◀** (lijevo) kako biste zatvorili izbornik.

Izjednačavanje audio izlaza

Postavku Izjednačavanje audio izlaza koristite za izjednačavanje glasnoće televizora i sustava kućnog kina prilikom prebacivanja s jednog na drugi. Razlike u glasnoći mogu uzrokovati razlike u obradi zvuka.

Izjednačavanje razlika u glasnoći...

- 1 - Pritisnite **⚙️**, odaberite **Sve postavke** i pritisnite **OK**.
- 2 - Odaberite **Zvuk** i pritisnite **▶** (desno) kako biste otvorili izbornik.
- 3 - Odaberite **Napredno >** **Izjednačavanje audio izlaza**.
- 4 - Ako je razlika u glasnoći velika, odaberite **Više**. Ako je razlika u glasnoći mala, odaberite **Manje**.
- 5 - Po potrebi više puta pritisnite **◀** (lijevo) kako biste zatvorili izbornik.

Izjednačavanje audio izlaza utječe i na audio izlaz – optičke i HDMI ARC signale zvuka.

Odgoda audio izlaza

Ako postavite usklađivanje kašnjenja zvuka na sustavu kućnog kina kako biste uskladili zvuk i sliku, morate isključiti opciju **Odgoda audio izlaza** na televizoru.

Isključivanje odgode audio izlaza...

- 1 - Pritisnite **⚙️**, odaberite **Sve postavke** i pritisnite **OK**.
- 2 - Odaberite **Zvuk** i pritisnite **▶** (desno) kako biste otvorili izbornik.
- 3 - Odaberite **Napredno >** **Odgoda audio izlaza**.
- 4 - Odaberite **Isključeno**.
- 5 - Po potrebi više puta pritisnite **◀** (lijevo) kako biste zatvorili izbornik.

Pomak audio izlaza

Ako ne možete postaviti kašnjenje na sustavu kućnog kina, možete postaviti odgodu na televizoru pomoću opcije **Pomak audio izlaza**.

Usklađivanje zvuka na televizoru...

- 1 - Pritisnite **⚙️**, odaberite **Sve postavke** i pritisnite **OK**.
- 2 - Odaberite **Zvuk** i pritisnite **▶** (desno) kako biste otvorili izbornik.
- 3 - Odaberite **Napredno >** **Pomak audio izlaza**.
- 4 - Pomoću klizne trake postavite pomak zvuka.
- 5 - Po potrebi više puta pritisnite **◀** (lijevo) kako biste zatvorili izbornik.

Zvučnici

Odaberite svoje zvučnike

U ovom izborniku možete uključiti ili isključiti zvučnike televizora. Ako povežete sustav kućnog kina ili bežični Bluetooth zvučnik, moći ćete odabrati uređaj za reprodukciju zvuka televizora. Svi dostupni sustavi zvučnika prikazani su na popisu.

Ako za audio uređaj (npr. sustav kućnog kina) koristite HDMI CEC vezu, možete odabrati Automatsko pokretanje značajke EasyLink. Televizor će uključiti audio uređaj, poslati zvuk televizora na uređaj i isključiti zvučnike televizora.

Postavljanje zvučnika televizora...

- 1 - Pritisnite **⚙️**, odaberite **Sve postavke** i pritisnite **OK**.
- 2 - Odaberite **Zvuk** i pritisnite **▶** (desno) kako biste otvorili izbornik.
- 3 - Odaberite **Napredno i** pritisnite **▶** (desno) kako biste otvorili izbornik.
- 4 - Odaberite **Zvučnici** i pritisnite **▶** (desno) kako biste otvorili izbornik.
- 5 - Odaberite **Uključeno, Isključeno** ili **Automatsko pokretanje značajke EasyLink**.
- 6 - Po potrebi više puta pritisnite **◀** (lijevo) kako biste zatvorili izbornik.

12.4

Postavke funkcije Ambilight

Ambilight stil

Kako biste pronašli više informacija, u izborniku **Pomoć** odaberite **Ključne riječi** i potražite **Ambilight stil**.

Postavke funkcije Ambilight

Svjetlina funkcije Ambilight

Opcija **Svjetlina** omogućava postavljanje razine svjetline za funkciju Ambilight.

Prilagodba razine...

- 1 - Pritisnite **⚙️**, odaberite **Sve postavke** i pritisnite **OK**.
- 2 - Odaberite **Ambilight** i pritisnite **▶** (desno) kako biste otvorili izbornik.
- 3 - Odaberite **Svjetlina**.
- 4 - Pritisnite strelice **▲** (gore) ili **▼** (dolje) kako biste prilagodili vrijednost.
- 5 - Po potrebi više puta pritisnite **◀** (lijevo) kako biste zatvorili izbornik.

Zasićenost funkcije Ambilight

Opcija **Zasićenost** omogućava postavljanje razine zasićenosti boje za funkciju Ambilight.

Prilagodba razine...

- 1 - Pritisnite , odaberite **Sve postavke** i pritisnite **OK**.
- 2 - Odaberite **Ambilight** i pritisnite **➤** (desno) kako biste otvorili izbornik.
- 3 - Odaberite **Zasićenost**.
- 4 - Pritisnite strelice **▲** (gore) ili **▼** (dolje) kako biste prilagodili vrijednost.
- 5 - Po potrebi više puta pritisnite **◀** (lijevo) kako biste zatvorili izbornik.

Napredne postavke za Ambilight

Boja zida

Opcija **Boja zida** omogućava vam da neutralizirate utjecaj boje zida na boje Ambilight osvjetljenja. Odaberite boju zida iza televizora i televizor će prilagoditi boje Ambilight osvjetljenja tako da izgledaju onako kako su i zamišljene.

Odabir boje zida . . .

- 1 - Pritisnite , odaberite **Sve postavke** i pritisnite **OK**.
- 2 - Odaberite **Ambilight** i pritisnite **➤** (desno) kako biste otvorili izbornik.
- 3 - Odaberite **Napredno > Boja zida**.
- 4 - Iz palete boja odaberite boju koja odgovara boji zida iza televizora.
- 5 - Po potrebi više puta pritisnite **◀** (lijevo) kako biste zatvorili izbornik.

Isključenje televizora

Opcija **Isključenje televizora** omogućava postavljanje funkcije Ambilight na trenutno isključenje ili sporo postepeno isključenje kada isključite televizor. Sporo postepeno isključenje daje vam vrijeme da uključite svjetlo u prostoriji.

Odabir načina isključenja funkcije Ambilight...

- 1 - Pritisnite , odaberite **Sve postavke** i pritisnite **OK**.
- 2 - Odaberite **Ambilight** i pritisnite **➤** (desno) kako biste otvorili izbornik.
- 3 - Odaberite **Napredno > Isključenje televizora**.
- 4 - Odaberite **Postupno isključenje** ili **Trenutno isključenje**.
- 5 - Po potrebi više puta pritisnite **◀** (lijevo) kako biste zatvorili izbornik.

Ambilight + Hue

Konfiguracija

1. korak – mreža

U prvom koraku pripremit ćete televizor za pronalaženje uređaja **Philips Hue Bridge**. Televizor i Philips Hue Bridge moraju koristiti istu mrežu.

Postavljanje...

- 1 - Priključite Philips Hue Bridge u strujnu utičnicu.
- 2 - Povežite Philips Hue Bridge putem istog usmjerivača koji koristite za televizor – za povezivanje upotrijebite Ethernet kabel.
- 3 - Uključite Hue žarulje.

Početak konfiguracije...

- 1 - Pritisnite , odaberite **Sve postavke** i pritisnite **OK**.
- 2 - Odaberite **Ambilight > Ambilight+Hue**.
- 3 - Odaberite **Konfiguracija**.
- 4 - Odaberite **Pokreni** i pritisnite **OK**. Televizor će potražiti Philips Hue Bridge. Ako televizor još uvijek nije povezan s vašom mrežom, najprije će pokrenuti postavljanje mreže. Ako se Philips Hue Bridge prikaže na popisu ...

prijedite na 2. korak – Hue Bridge.

Kako biste pronašli više informacija o povezivanju televizora s kućnom mrežom, u izborniku **Pomoć** odaberite **Ključne riječi** i potražite **Mreža, bežična**.

2. korak – Hue Bridge

U sljedećem koraku povezat ćete televizor i **Philips Hue Bridge**.

Televizor može biti povezan sa samo jednim uređajem Hue Bridge.

Povezivanje uređaja Hue Bridge...

- 1 - Dok je televizor povezan s kućnom mrežom, prikazivat će dostupni uređaji Hue Bridge. Ako televizor još nije pronašao vaš Hue Bridge, odaberite **Ponovo pretraži** i pritisnite **OK**. Ako je televizor pronašao jedini Hue Bridge koji imate, odaberite naziv uređaja Hue Bridge i pritisnite **OK**. Ako imate više dostupnih uređaja Hue Bridge, odaberite željeni Hue Bridge i pritisnite **OK**.
- 2 - Odaberite **Pokreni** i pritisnite **OK**.
- 3 - Sada idite do uređaja **Philips Hue Bridge** i pritisnite gumb veze u sredini uređaja. Time ćete povezati Hue Bridge s televizorom. Učinite to unutar 30 sekundi. Televizor će potvrditi ako je Hue Bridge povezan s televizorom.
- 4 - Odaberite **OK** i pritisnite **OK**.

Nakon povezivanja Philips Hue mosta s televizorom idite na stranicu **Hue žarulje**.

3. korak – Hue žarulje

U sljedećem koraku odabrat ćete Philips Hue žarulje koje trebaju pratiti Ambilight.

Možete odabrati najviše 9 Philips Hue žarulja za Ambilight+Hue.

Odabir žarulja za Ambilight+Hue...

1 – Na popisu označite žarulje koje trebaju pratiti Ambilight. Kako biste označili žarulju, odaberite njezin naziv i pritisnite OK. Nakon što je označite, žarulja će dvaput zatreperiti.

2 – Kada završite, odaberite OK i pritisnite OK.

4. korak – konfiguracija žarulje

U sljedećem koraku konfigurirat ćete svaku Philips Hue žarulju.

Konfiguracija svake Hue žarulje...

1 – Odaberite žarulju za konfiguraciju i pritisnite OK. Odabrana će žarulja zatreperiti.

2 – Odaberite Pokreni i pritisnite OK.

3 – Najprije naznačite gdje ste smjestili žarulju u odnosu na televizor. Ispravnim postavljanjem opcije Kut omogućit ćete slanje odgovarajuće Ambilight boje žarulji. Odaberite kliznu traku za podešavanje položaja.

4 – Nakon toga naznačite Udaljenost između žarulje i televizora. Što je udaljenost od televizora veća, to je Ambilight boja slabija. Odaberite kliznu traku za podešavanje udaljenosti.

5 – Na kraju postavite opciju Svjetlina za žarulju. Odaberite kliznu traku za podešavanje svjetline.

6 – Kako biste zaustavili konfiguraciju ove žarulje, odaberite OK i pritisnite OK.

7 – U izborniku Konfiguriraj Ambilight+Hue možete učiniti isto za svaku žarulju.

8 – Nakon konfiguracije svih Ambilight+Hue žarulja odaberite Završi i pritisnite OK.

Funkcija Ambilight+Hue spremna je za uporabu.

Isključivanje

Isključivanje funkcije Ambilight+Hue...

1 – Pritisnite , odaberite Sve postavke i pritisnite OK.

2 – Odaberite Ambilight i pritisnite  (desno) kako biste otvorili izbornik.

3 – Odaberite Ambilight+Hue.

4 – Odaberite Isključeno ili Uključeno.

5 – Po potrebi više puta pritisnite  (lijevo) kako biste zatvorili izbornik.

Uranjanje u doživljaj



Opcija Uranjanje u doživljaj omogućuje vam da odredite koliko precizno Hue žarulje prate Ambilight.

Prilagodba opcije Uranjanje u doživljaj za funkciju Ambilight+Hue...

1 – Pritisnite , odaberite Sve postavke i pritisnite OK.

2 – Odaberite Ambilight i pritisnite  (desno) kako biste otvorili izbornik.

3 – Odaberite Ambilight+Hue > Uranjanje u doživljaj.

4 – Pritisnite strelice  (gore) ili  (dolje) kako biste prilagodili vrijednost.

5 – Po potrebi više puta pritisnite  (lijevo) kako biste zatvorili izbornik.

Lounge Light+Hue

Ako ste instalirali Ambilight+Hue, možete postaviti Hue žarulje tako da prate Lounge Light funkcije Ambilight. Philips Hue svjetiljke proširit će Lounge Light efekt na cijelu prostoriju. Hue žarulje uključuju se i automatski postavljaju tako da prate Lounge Light kada konfigurirate Ambilight+Hue. Ako ne želite da Hue žarulje prate Lounge Light efekt, možete ih isključiti.

Isključivanje Hue žarulja...

1 – Pritisnite , odaberite Sve postavke i pritisnite OK.

2 – Odaberite Ambilight i pritisnite  (desno) kako biste otvorili izbornik.

3 – Odaberite Ambilight+Hue > Lounge Light+Hue.

4 – Odaberite Isključeno.

5 – Po potrebi više puta pritisnite  (lijevo) kako biste zatvorili izbornik.

Prikaži konfiguraciju

Opcija Prikaži konfiguraciju omogućava prikaz trenutnih postavki za Ambilight+Hue, mrežu, most i žarulje.

Prikaz Ambilight+Hue konfiguracije...

1 – Pritisnite , odaberite Sve postavke i pritisnite OK.

2 – Odaberite Ambilight i pritisnite  (desno) kako biste otvorili izbornik.

3 – Odaberite Ambilight+Hue > Prikaži konfiguraciju.

4 – Po potrebi više puta pritisnite  (lijevo) kako biste zatvorili izbornik.

Ponovo postavi konfiguraciju

Ponovno postavljanje funkcije Ambilight+Hue...

- 1 - Pritisnite , odaberite **Sve postavke** i pritisnite **OK**.
- 2 - Odaberite **Ambilight** i pritisnite **➤** (desno) kako biste otvorili izbornik.
- 3 - Odaberite **Ambilight+Hue > Ponovo postavi konfiguraciju**. Konfiguracija će se ponovo postaviti.
- 4 - Po potrebi više puta pritisnite **◀** (lijevo) kako biste zatvorili izbornik.

12.5

Ekološke postavke

Ušteda energije

Ekološke postavke  obuhvaćaju postavke televizora koje pomažu u zaštiti okoliša.

Ušteda energije

Ako odaberete opciju Ušteda energije, televizor će automatski prijeći na stil slike Standardno, energetski najučinkovitiju postavku za sliku.

Postavljanje televizora u opciji Ušteda energije...

- 1 - Pritisnite , odaberite **Sve postavke** i pritisnite **OK**.
- 2 - Odaberite **Ekološke postavke** i pritisnite **➤** (desno) kako biste otvorili izbornik.
- 3 - Odaberite **Ušteda energije, Stil slike** automatski će se postaviti na **Standardno**.
- 4 - Po potrebi više puta pritisnite **◀** (lijevo) kako biste zatvorili izbornik.

Zaslon isključen

Ako samo slušate glazbu, možete isključiti zaslon televizora radi uštede energije.

Isključivanje samo zaslona televizora...

- 1 - Pritisnite , odaberite **Sve postavke** i pritisnite **OK**.
- 2 - Odaberite **Ekološke postavke** i pritisnite **➤** (desno) kako biste otvorili izbornik.
- 3 - Odaberite **Zaslon isključen**. Zaslon će se isključiti.
- 4 - Po potrebi više puta pritisnite **◀** (lijevo) kako biste zatvorili izbornik.

Kako biste ponovo uključili zaslon, pritisnite bilo koju tipku na daljinskom upravljaču.

Mjerač vremena za isključivanje

Ako televizor prima televizijski signal, ali tijekom razdoblja od 4 sata ne pritisnete nijednu tipku na daljinskom upravljaču, televizor će se automatski isključiti radi uštede energije. Isto tako, ako televizor ne primi televizijski signal niti naredbu s daljinskog upravljača 10 minuta, automatski će se isključiti.

Ako televizor koristite kao monitor ili koristite digitalni prijemnik za gledanje televizije (Set-Top Box – STB) i ne koristite daljinski upravljač televizora, isključite funkciju automatskog isključivanja.

Deaktivacija mjerača vremena za isključivanje ...

- 1 - Pritisnite , odaberite **Sve postavke** i pritisnite **OK**.
- 2 - Odaberite **Ekološke postavke** i pritisnite **➤** (desno) kako biste otvorili izbornik.
- 3 - Odaberite **Mjerač vremena za isključivanje**.
- 4 - Pritisnite strelice **▲** (gore) ili **▼** (dolje) kako biste prilagodili vrijednost. Vrijednost **0** deaktivirat će automatsko isključivanje.
- 5 - Po potrebi više puta pritisnite **◀** (lijevo) kako biste zatvorili izbornik.

12.6

Općenite postavke

USB tvrdi disk

Postavljanje i formatiranje USB tvrdog diska...

- 1 - Pritisnite , odaberite **Sve postavke** i pritisnite **OK**.
- 2 - Odaberite **Općenite postavke** i pritisnite **➤** (desno) kako biste otvorili izbornik.
- 3 - Odaberite **USB tvrdi disk**.
- 4 - Odaberite **Pokreni**, a zatim slijedite upute na zaslonu.
- 5 - Po potrebi više puta pritisnite **◀** (lijevo) kako biste zatvorili izbornik.

Kako biste pronašli više informacija o instalaciji USB tvrdog diska, u izborniku **Pomoć**, odaberite **Ključne riječi** i potražite **USB tvrdi disk, instalacija** ili **Instalacija, USB tvrdi disk**.

Postavke USB tipkovnice

Kako biste instalirali USB tipkovnicu, uključite televizor i priključite USB tipkovnicu na jednu od **USB** priključnica na televizoru. Kada televizor prvi put prepozna tipkovnicu, možete odabrati raspored tipkovnice i testirati odabir. Ako najprije odaberete ćirilčni ili grčki raspored tipkovnice, možete odabrati sekundarni latinični raspored.

Promjena postavke rasporeda tipkovnice nakon odabira rasporeda...

- 1 - Pritisnite , odaberite Sve postavke i pritisnite OK.
- 2 - Odaberite Općenite postavke i pritisnite **>** (desno) kako biste otvorili izbornik.
- 3 - Odaberite Postavke USB tipkovnice i pokrenite postavljanje tipkovnice.

Svjetlina Philips logotipa

Osvjetljenje logotipa Philips na prednjoj strani televizora možete isključiti ili prilagoditi njegovu razinu.

Prilagodba ili isključivanje...

- 1 - Pritisnite , odaberite Sve postavke i pritisnite OK.
- 2 - Odaberite Općenite postavke i pritisnite **>** (desno) kako biste otvorili izbornik.
- 3 - Odaberite Svjetlina Philips logotipa i pritisnite **>** (desno) kako biste otvorili izbornik.
- 4 - Odaberite Minimalna, Srednje, Maksimalna, ili Isključeno kako biste isključili osvjetljenje logotipa.
- 5 - Po potrebi više puta pritisnite **<** (lijevo) kako biste zatvorili izbornik.



Dom ili trgovina

Ako se televizor nalazi u trgovini, možete ga postaviti tako da se prikazuje promocijski natpis za trgovinu. Stil slike automatski će se postaviti na Živo. Mjerač vremena za isključivanje isključen je.

Postavljanje televizora na mjesto Trgovina...

- 1 - Pritisnite , odaberite Sve postavke i pritisnite OK.
- 2 - Odaberite Općenite postavke i pritisnite **>** (desno) kako biste otvorili izbornik.
- 3 - Odaberite Mjesto > Trgovina.
- 4 - Po potrebi više puta pritisnite **<** (lijevo) kako biste zatvorili izbornik.

Ako televizor koristite kod kuće, postavite televizor na mjesto Dom.

Postavljanje za trgovinu

Ako je televizor postavljen na opciju Trgovina, možete postaviti dostupnost određene demonstracije za upotrebu u trgovini.

- 1 - Pritisnite , odaberite Sve postavke i pritisnite OK.
- 2 - Odaberite Općenite postavke i pritisnite **>** (desno) kako biste otvorili izbornik.
- 3 - Odaberite Konfiguracija za trgovinu i pritisnite **>** (desno) kako biste otvorili izbornik.
- 4 - Postavke prilagodite svojim željama.
- 5 - Po potrebi više puta pritisnite **<** (lijevo) kako biste zatvorili izbornik.

EasyLink

EasyLink

Kako biste u potpunosti isključili EasyLink...

- 1 - Pritisnite , odaberite Sve postavke i pritisnite OK.
- 2 - Odaberite Općenite postavke i pritisnite **>** (desno) kako biste otvorili izbornik.
- 3 - Odaberite EasyLink, pritisnite **>** (desno) i odaberite EasyLink u sljedećem koraku.
- 4 - Odaberite Isključeno.
- 5 - Po potrebi više puta pritisnite **<** (lijevo) kako biste zatvorili izbornik.

Daljinski upravljač EasyLink

Isključivanje daljinskog upravljača EasyLink...

- 1 - Pritisnite , odaberite Sve postavke i pritisnite OK.
- 2 - Odaberite Općenite postavke i pritisnite **>** (desno) kako biste otvorili izbornik.
- 3 - Odaberite EasyLink > Daljinski upravljač EasyLink.
- 4 - Odaberite Isključeno.
- 5 - Po potrebi više puta pritisnite **<** (lijevo) kako biste zatvorili izbornik.

Napredne postavke

TV vodič

TV vodič prima informacije (podatke) od televizijskih kuća ili s interneta. U nekim regijama i za neke kanale, informacije TV vodiča možda neće biti dostupne. Televizor može prikupljati informacije TV vodiča za kanale instalirane na televizoru. Televizor ne može prikupljati informacije TV vodiča za kanale koji se gledaju putem digitalnog prijemnika ili dekodera.

Televizor se isporučuje sa zadanom opcijom **Od televizijske kuće**.

Ako informacije TV vodiča dolaze s interneta, TV vodič može prikazati popis analognih kanala uz digitalne. Izbornik TV vodiča prikazuje i mali zaslon s kanalom koji trenutno gledate.

S Interneta

Ako je televizor povezan s internetom, možete ga postaviti tako da informacije TV vodiča prima s interneta.

Postavljanje informacija TV vodiča...

- 1 - Pritisnite , odaberite **Sve postavke** i pritisnite **OK**.
- 2 - Odaberite **Općenite postavke** i pritisnite **➤** (desno) kako biste otvorili izbornik.
- 3 - Odaberite **Napredno > TV vodič > S interneta**.
- 4 - Po potrebi više puta pritisnite **◀** (lijevo) kako biste zatvorili izbornik.

Logotipovi kanala

U nekim državama televizor može prikazivati i logotip kanala.

Ako ne želite da se logotipovi prikazuju, možete ih isključiti.

Isključivanje prikaza logotipova...

- 1 - Pritisnite , odaberite **Sve postavke** i pritisnite **OK**.
- 2 - Odaberite **Općenite postavke** i pritisnite **➤** (desno) kako biste otvorili izbornik.
- 3 - Odaberite **Napredno > Logotipovi kanala** i pritisnite **➤** (desno) kako biste otvorili izbornik.
- 4 - Odaberite **Isključeno**.
- 5 - Po potrebi više puta pritisnite **◀** (lijevo) kako biste zatvorili izbornik.

HbbTV

Ako televizijski kanal nudi HbbTV stranice, najprije trebate uključiti HbbTV u televizijskim postavkama kako bi se stranice mogle prikazati.

- 1 - Pritisnite , odaberite **Sve postavke** i pritisnite **OK**.
- 2 - Odaberite **Općenite postavke** i pritisnite **➤** (desno) kako biste otvorili izbornik.
- 3 - Odaberite **Napredno > HbbTV**.
- 4 - Odaberite **Uključeno** ili **Isključeno**.
- 5 - Po potrebi više puta pritisnite **◀** (lijevo) kako biste zatvorili izbornik.

Ako ne želite pristup HbbTV stranicama na određenom kanalu, možete blokirati HbbTV stranice samo za taj kanal.

- 1 - Prijedite na kanal na kojem želite blokirati HbbTV

stranice.

2 - Pritisnite

+ OPTIONS, odaberite **Preference > HbbTV na ovom kanalu**.

3 - Odaberite **Isključeno**.

Tvorničke postavke

Možete postaviti televizor natrag na originalne postavke (tvorničke postavke).

Vraćanje na originalne postavke...

- 1 - Pritisnite , odaberite **Sve postavke** i pritisnite **OK**.
- 2 - Odaberite **Općenite postavke** i pritisnite **➤** (desno) kako biste otvorili izbornik.
- 3 - Odaberite **Tvorničke postavke**.
- 4 - Odaberite **OK**.
- 5 - Po potrebi više puta pritisnite **◀** (lijevo) kako biste zatvorili izbornik.

Ponovna instalacija televizora

Možete ponoviti potpunu instalaciju televizora. Televizor će se potpuno ponovo instalirati.

Ponavljanje potpune instalacije televizora...

- 1 - Pritisnite , odaberite **Sve postavke** i pritisnite **OK**.
- 2 - Odaberite **Općenite postavke** te **Ponovna instalacija televizora**.
- 3 - Slijedite upute na zaslonu. Instalacija može potrajati nekoliko minuta.

12.7

Sat, regija i jezik

Jezik izbornika

Promjena jezika izbornika televizora i poruka...

- 1 - Pritisnite , odaberite **Sve postavke** i pritisnite **OK**.
- 2 - Odaberite **Regija i jezik** i pritisnite **➤** (desno) kako biste otvorili izbornik.
- 3 - Odaberite **Jezik > Jezik izbornika**.
- 4 - Odaberite željeni jezik^o i pritisnite **OK**.
- 5 - Po potrebi više puta pritisnite **◀** (lijevo) kako biste zatvorili izbornik.

Preferencije jezika

Postavke audio jezika

Digitalni televizijski kanali mogu emitirati nekoliko audio jezika za određeni program. Možete postaviti željeni primarni i sekundarni audio jezik. Ako je dostupan jedan od tih audio jezika, televizor će prijeći na njega.

Ako nije dostupan nijedan od željenih audio jezika, možete odabrati neki drugi audio jezik koji je dostupan.

Postavljanje primarnog i sekundarnog audio jezika...

- 1 - Pritisnite , odaberite **Sve postavke** i pritisnite **OK**.
- 2 - Odaberite **Regija i jezik** i pritisnite **>** (desno) kako biste otvorili izbornik.
- 3 - Odaberite **Jezici > Primarni zvuk** ili **Sekundarni audio**.
- 4 - Odaberite željeni jezik.
- 5 - Po potrebi više puta pritisnite **<** (lijevo) kako biste zatvorili izbornik.

Titlovi

Uključivanje

Kako biste uključili titlove, pritisnite **SUBTITLE**.

Za titlove možete odabrati opcije **Uključeno**, **Isključeno** ili **Uključeno za vrijeme stišanog zvuka**.

Kako bi se titlovi automatski prikazivali kada emitirani program nije na jeziku koji je postavljen za televizor, odaberite **Automatski**. Ova postavka omogućava i automatski prikaz titlova kada isključite zvuk.

Postavke jezika titlova

Digitalni kanali mogu nuditi nekoliko jezika titlova za program. Možete postaviti željeni primarni i sekundarni jezik titlova. Ako su dostupni titlovi na jednom od tih jezika, televizor će prikazati titlove koje ste odabrali.

Ako nije dostupan nijedan od željenih jezika titlova, možete odabrati neki drugi jezik titlova koji je dostupan.

Postavljanje primarnog i sekundarnog jezika titlova...

- 1 - Pritisnite , odaberite **Sve postavke** i pritisnite **OK**.
- 2 - Odaberite **Regija i jezik** i pritisnite **>** (desno) kako biste otvorili izbornik.
- 3 - Odaberite **Jezici > Primarni titlovi** ili **Sekundarni titlovi**.
- 4 - Odaberite željeni jezik.

5 - Po potrebi više puta pritisnite **<** (lijevo) kako biste zatvorili izbornik.

Titlovi iz teleteksta

Ako prijedete na analogni kanal, titlove morate ručno učiniti dostupnima za svaki kanal.

- 1 - Prijedite na kanal i pritisnite **TEXT** kako biste otvorili teletekst.
- 2 - Unesite broj stranice za titlove, obično **888**.
- 3 - Ponovo pritisnite **TEXT** kako biste zatvorili teletekst.

Ako u izborniku **Titlovi** odaberete **Uključeno** dok gledate određeni analogni kanal, titlovi će se prikazati ako su dostupni.

Jezici teleteksta

Stranice teleteksta

Kako biste otvorili teletekst, dok gledate televizijske kanale pritisnite **TEXT**.
Kako biste zatvorili teletekst, ponovo pritisnite **TEXT**.

Odabir stranice teleteksta

Odabir stranice . . .

- 1 - Unesite broj stranice pomoću numeričkih tipki.
- 2 - Krećite se pomoću navigacijskih tipki.
- 3 - Pritisnite tipku u boji za odabir neke od stavki označenih bojama na dnu zaslona.

Podstranice teleteksta

Pod brojem stranice teleteksta može biti nekoliko podstranica. Brojevi podstranica prikazuju se na traci pokraj broja glavne stranice.
Za odabir podstranice pritisnite **<** ili **>**.

T.O.P. Stranice teleteksta

Neke televizijske kuće nude T.O.P. teleteksta. Otvaranje T.O.P. teleteksta unutar teleteksta – pritisnite **+ OPTIONS** i odaberite T.O.P. **pregled**.

Omiljene stranice

Televizor sastavlja popis posljednjih 10 otvorenih stranica teleteksta. Možete ih jednostavno ponovo otvoriti u stupcu **Omiljene stranice** teleteksta.

- 1 - U prikazu teleteksta odaberite zvjezdicu u gornjem lijevom kutu zaslona kako bi se prikazao stupac **omiljenih stranica**.
- 2 - Pritisnite **▼** (dolje) ili **▲** (gore) kako biste odabrali broj stranice i pritisnite **OK** za otvaranje stranice.

Popis možete očistiti tako da odaberete **Izbriši omiljene stranice**.

Pretraživanje teleteksta

Možete odabrati riječ i zatim u tekstu pretražiti sva

pojavljivanja te riječi.

- 1 - Otvorite stranicu teleteksta i pritisnite **OK**.
- 2 - Pomoću tipki sa strelicama odaberite riječ ili broj.
- 3 - Ponovo pritisnite **OK** kako biste odmah prešli na sljedeće mjesto na kojem se pojavljuje određena riječ ili broj.
- 4 - Ponovo pritisnite **OK** za prelazak na sljedeće mjesto.
- 5 - Kako biste zaustavili pretraživanje, pritiščite **▲** (gore) dok više ništa ne bude odabrano.

Teletekst s povezanog uređaja

Neki uređaji koji primaju televizijske kanale mogu nuditi i teletekst.

Otvaranje teleteksta s povezanog uređaja . . .

- 1 - Pritisnite **➡** odaberite uređaj i pritisnite **OK**.
- 2 - Dok gledate kanal na uređaju, pritisnite **+ OPTIONS** , odaberite **Prikaz tipki uređaja** i odaberite tipku **☰** te pritisnite **OK**.
- 3 - Pritisnite **← BACK** kako biste sakrili tipke uređaja.
- 4 - Kako biste zatvorili teletekst, ponovo pritisnite **← BACK** .

Digitalni tekst (samo u Ujedinjenom Kraljevstvu)

Neke televizijske kuće koje emitiraju digitalne programe nude namjenske usluge digitalnog teksta ili interaktivne televizije na svojim digitalnim televizijskim kanalima. To obuhvaća uobičajeni teletekst za koji se upotrebljavaju numeričke tipke, tipke sa strelicama i tipke u boji za odabir i kretanje.

Kako biste zatvorili digitalni tekst, pritisnite **← BACK** .

Opcije teleteksta

U teletekstu pritisnite **+ OPTIONS** za sljedeći odabir...

- **Zamrzavanje stranice**
Zaustavljanje automatske rotacije podstranica.
- **Dvostruki prikaz na zaslonu / Pun zaslon**
Prikaz televizijskog kanala i teleteksta jednoga uz drugi.
- **T.O.P. pregled**
Otvaranje T.O.P. teleteksta.
- **Povećavanje**
Povećanje stranice teleteksta radi ugodnijeg čitanja.
- **Prikaz**
Prikaz skrivenih informacija na stranici.
- **Listanje podstranica**
Listanje podstranica kada su one dostupne.
- **Jezik**
Promjena skupine znakova koje teletekst koristi za ispravan prikaz.
- **Teletekst 2.5**
Aktivacija Teleteksta 2.5 koji nudi više boja i bolju grafiku.

Postavljanje teleteksta

Jezik teleteksta

Neke televizijske kuće koje emitiraju digitalne programe nude više jezika teleteksta. Postavljanje primarnog i sekundarnog jezika teleteksta . . .

- 1 - Pritisnite **⚙️**, odaberite **Sve postavke** i pritisnite **OK**.
- 2 - Odaberite **Regija i jezik** i pritisnite **➤** (desno) kako biste otvorili izbornik.
- 3 - Odaberite **Jezik > Primarni teletekst** ili **Sekundarni teletekst**.
- 4 - Odaberite željene jezike teleteksta.
- 5 - Po potrebi više puta pritisnite **◀** (lijevo) kako biste zatvorili izbornik.

Teletekst 2.5

Ako je dostupan, Teletekst 2.5 pruža više boja i bolju grafiku. Teletekst 2.5 je aktiviran kao standardna tvornička postavka.

Isključivanje Teleteksta 2.5...

- 1 - Pritisnite **TEXT**.
- 2 - Dok je teletekst otvoren na zaslonu, pritisnite **+ OPTIONS**.
- 3 - Odaberite **Teletekst 2.5 > Isključeno**.
- 4 - Po potrebi više puta pritisnite **◀** (lijevo) kako biste zatvorili izbornik.

Sat

Datum i vrijeme

Automatski

Standardna postavka za sat televizora je **Automatski**. Točno vrijeme dobiva se iz informacija UTC – koordiniranog univerzalnog vremena.

Ako sat televizora nije točno postavljen, možete odabrati opciju **Ovisno o državi**. Za određene države možete odabrati specifičnu vremensku zonu ili pak postaviti vremensko odstupanje. U nekim državama i kod nekih davatelja usluge mreže postavke sata skrivene su kako bi se izbjeglo pogrešno postavljanje sata.

Postavljanje sata na televizoru...

- 1 - Pritisnite **⚙️**, odaberite **Sve postavke** i pritisnite **OK**.
- 2 - Odaberite **Regija i jezik** i odaberite **Sat > Način rada automatskog sata**.
- 3 - Odaberite **Automatski** ili **Ovisno o državi**.
- 4 - Za vraćanje jedan korak pritisnite **◀** (lijevo).

Ručno

Ako nijedna od automatskih postavki ne prikazuje ispravno vrijeme, možete ga postaviti ručno.

Međutim, ako zakazujete snimanje putem TV vodiča, preporučujemo da vrijeme i datum ne mijenjate ručno. U nekim državama i kod nekih davatelja usluge mreže postavke sata skrivene su kako bi se izbjeglo pogrešno postavljanje sata.

Za ručno postavljanje sata na televizoru (ako je dostupno)...

- 1 - Pritisnite , odaberite **Sve postavke** i pritisnite **OK**.
- 2 - Odaberite **Regija i jezik**, odaberite **Sat > Način rada automatskog sata** i pritisnite **OK**.
- 3 - Odaberite **Ručno** i pritisnite **OK**.
- 4 - Pritisnite **<** (lijevo) i odaberite **Datum ili Vrijeme**.
- 5 - Pritisnite **^** (gore) ili **v** (dolje) kako biste prilagodili vrijednost.
- 6 - Za vraćanje jedan korak pritisnite **<** (lijevo).

Vremenska zona

U određenim državama možete odabrati specifične vremenske zone za pravilno postavljanje sata na televizoru.

Za postavljanje vremenske zone (ako je dostupno)...

- 1 - Pritisnite , odaberite **Sve postavke** i pritisnite **OK**.
- 2 - Odaberite **Regija i jezik** i pritisnite **>** (desno) kako biste otvorili izbornik.
- 3 - Odaberite **Sat > Vremenska zona**.
- 4 - U ovisnosti o svojoj državi, moći ćete odabrati vremensku zonu ili postaviti vremensko odstupanje kako biste ispravili sat na televizoru.
- 5 - Po potrebi više puta pritisnite **<** (lijevo) kako biste zatvorili izbornik.

Automatsko isključivanje

Opcija **Automatsko isključivanje** omogućava postavljanje televizora za automatski prelazak u stanje pripravnosti nakon zadanog vremena.

Postavljanje automatskog isključivanja...

- 1 - Pritisnite , odaberite **Sve postavke** i pritisnite **OK**.
- 2 - Odaberite **Regija i jezik** i pritisnite **>** (desno) kako biste otvorili izbornik.
- 3 - Odaberite **Sat > Mjerač vremena za stanje mirovanja**.
- 4 - Pomoću klizne trake možete postaviti vrijeme do 180 minuta u povećanjima od 5 minuta. Ako je postavljeno na 0 minuta, automatsko isključivanje se isključuje. Tijekom odbrojavanja uvijek možete ranije

isključiti televizor ili ponovo postaviti vrijeme.
5 - Po potrebi više puta pritisnite **<** (lijevo) kako biste zatvorili izbornik.

12.8

Univerzalni pristup

Uključivanje

Dok je opcija **Univerzalni pristup** uključena, televizor je pripremljen tako da ga mogu koristiti gluhe, nagluhe, slijepe ili djelomično slijepe osobe.

Uključivanje

Ako **Univerzalni pristup** niste uključili prilikom instalacije, još uvijek ga možete uključiti u izborniku **Univerzalni pristup**.

Uključivanje opcije **Pristupačnost**...

- 1 - Pritisnite , odaberite **Sve postavke** i pritisnite **OK**.
- 2 - Odaberite **Univerzalni pristup** i pritisnite **>** (desno) kako biste otvorili izbornik.
- 3 - Odaberite **Univerzalni pristup** u narednom koraku.
- 4 - Odaberite **Uključeno**.
- 5 - Po potrebi više puta pritisnite **<** (lijevo) kako biste zatvorili izbornik.

Osobe oštećena sluha

Neki digitalni kanali emitiraju poseban zvuk i titlove prilagođene osobama oštećena sluha ili gluhima. Dok je uključena opcija **Osobe oštećena sluha**, televizor automatski prelazi na prilagođeni zvuk i titlove, ako su dostupni. Kako biste mogli uključiti opciju **Osobe oštećena sluha**, morate uključiti **Univerzalni pristup**.

Uključivanje opcije **Osobe oštećena sluha**...

- 1 - Pritisnite , odaberite **Sve postavke** i pritisnite **OK**.
- 2 - Odaberite **Univerzalni pristup** i pritisnite **>** (desno) kako biste otvorili izbornik.
- 3 - Odaberite **Osobe oštećena sluha** i pritisnite **>** (desno) kako biste otvorili izbornik.
- 4 - Odaberite **Uključeno**.
- 5 - Po potrebi više puta pritisnite **<** (lijevo) kako biste zatvorili izbornik.

Audioopis

Uključivanje

Digitalni televizijski kanali mogu emitirati poseban audio komentar u kojem se opisuje ono što se događa na zaslonu.

Kako biste mogli postaviti zvuk i efekte za osobe slabijeg vida, najprije morate uključiti **Audioopis**. Osim toga, kako biste mogli uključiti **Audioopis**, morate uključiti **Univerzalni pristup** u izborniku za postavljanje.

Ako je uključena opcija **Audioopis**, normalnom zvuku dodaje se komentar pripovjedača.

Uključivanje komentara (ako je dostupan)...

Uključivanje opcije **Audioopis**...

- 1 - Pritisnite , odaberite **Sve postavke** i pritisnite **OK**.
- 2 - Odaberite **Univerzalni pristup** i pritisnite **➤** (desno) kako biste otvorili izbornik.
- 3 - Odaberite **Audioopis** i pritisnite **➤** (desno) kako biste otvorili izbornik.
- 4 - Odaberite **Audioopis** u narednom koraku.
- 5 - Odaberite **Uključeno**.
- 6 - Po potrebi više puta pritisnite **◀** (lijevo) kako biste zatvorili izbornik.

Kombinirana glasnoća

Glasnoću normalnog zvuka možete miješati s audio komentarom.

Miješanje glasnoće...

- 1 - Pritisnite , odaberite **Sve postavke** i pritisnite **OK**.
- 2 - Odaberite **Univerzalni pristup** i pritisnite **➤** (desno) kako biste otvorili izbornik.
- 3 - Odaberite **Audioopis** > **Kombinirana glasnoća**.
- 4 - Pritisnite strelice **▲** (gore) ili **▼** (dolje) kako biste prilagodili vrijednost.
- 5 - Po potrebi više puta pritisnite **◀** (lijevo) kako biste zatvorili izbornik.

Zvučni efekt

Neki audio komentari mogu imati dodatne audio efekte, npr. stereo ili zvuk koji se postepeno smanjuje.

Uključivanje opcije **Zvučni efekti** (ako je dostupna)...

- 1 - Pritisnite , odaberite **Sve postavke** i pritisnite **OK**.
- 2 - Odaberite **Univerzalni pristup** i pritisnite **➤** (desno) kako biste otvorili izbornik.
- 3 - Odaberite **Audioopis** > **Zvučni efekti**.
- 4 - Odaberite **Uključeno**.
- 5 - Po potrebi više puta pritisnite **◀** (lijevo) kako

biste zatvorili izbornik.

Govor

Audio komentar može obuhvaćati titlove za riječi koje se izgovaraju.

Uključivanje tih titlova (ako su dostupni) . . .

- 1 - Pritisnite , odaberite **Sve postavke** i pritisnite **OK**.
- 2 - Odaberite **Univerzalni pristup** i pritisnite **➤** (desno) kako biste otvorili izbornik.
- 3 - Odaberite **Audioopis** > **Govor**.
- 4 - Odaberite **Opisno** ili **Titl**.
- 5 - Po potrebi više puta pritisnite **◀** (lijevo) kako biste zatvorili izbornik.

12.9

Blokada uređaja

Roditeljski nadzor

Postavljanje najmanje dobi za gledanje programa namijenjenih određenim dobnim skupinama...

- 1 - Pritisnite , odaberite **Sve postavke** i pritisnite **OK**.
- 2 - Odaberite **Blokada uređaja** i pritisnite **➤** (desno) kako biste otvorili izbornik.
- 3 - Odaberite **Roditeljski nadzor** i odaberite dob na popisu.
- 4 - Po potrebi više puta pritisnite **◀** (lijevo) kako biste zatvorili izbornik.

Zaključavanje aplikacije

Kako biste pronašli više informacija, u izborniku **Pomoć** odaberite **Glavne riječi** i potražite **Zaključavanje aplikacije**.

Postavljanje/promjena koda

PIN kôd za blokadu uređaja koristi se za zaključavanje/otključavanje kanala ili programa.

Postavljanje koda za blokadu ili promjena trenutnog koda...

- 1 - Pritisnite , odaberite **Sve postavke** i pritisnite **OK**.
- 2 - Odaberite **Blokada uređaja** i pritisnite **➤** (desno) kako biste otvorili izbornik.
- 3 - Odaberite **Postavi kôd** ili **Promijeni kôd**.
- 4 - Unesite željeni četveroznamenkasti kôd. Ako je kôd već postavljen, unesite trenutni kôd za blokadu uređaja, a zatim dvaput unesite novi kôd.

5 - Po potrebi više puta pritisnite ◀ (lijevo) kako biste zatvorili izbornik.

Novi kôd je postavljen.

Zaboravili ste PIN kôd za blokadu?

Ako ste zaboravili PIN kôd, možete zamijeniti trenutni kôd i unijeti novi.

1 - Pritisnite ⚙️, odaberite Sve postavke i pritisnite OK.

2 - Odaberite Blokada uređaja i pritisnite ▶️ (desno) kako biste otvorili izbornik.

3 - Odaberite Promijeni kôd.

4 - Unesite kôd za zaobilaženje 8888.

5 - Sada unesite novi PIN kôd za blokadu i zatim ga unesite ponovo kako biste potvrdili.

6 - Po potrebi više puta pritisnite ◀️ (lijevo) kako biste zatvorili izbornik.

Novi kôd je postavljen.

Videozapisi, fotografije i glazba





13.1

S povezanog USB uređaja

Možete prikazivati fotografije ili reproducirati glazbu i videozapise s povezanog USB flash memorije ili USB tvrdog diska.

Dok je televizor uključen priključite USB flash pogon ili USB tvrdi disk u jednu od USB priključnica. Televizor će prepoznati uređaj i prikazati popis multimedijjskih datoteka.

Ako se popis datoteka ne prikaže automatski...

- 1 - Pritisnite  SOURCES, odaberite  USB i pritisnite OK.
- 2 - Odaberite  USB uređaji i pritisnite  (desno) kako biste pretraživali datoteke u strukturi mape koju ste organizirali na pogonu.
- 3 - Za zaustavljanje reprodukcije videozapisa, fotografija i glazbe pritisnite  EXIT.

Upozorenje

Ako pokušate pauzirati ili snimati program dok je USB tvrdi disk povezan, televizor će zatražiti formatiranje USB tvrdog diska. Tim formatiranjem izbrisat će se sve datoteke koje se nalaze na USB tvrdom disku.

13.2

S računala ili NAS uređaja



Možete pregledati fotografije ili reproducirati glazbu i videozapise s računala ili NAS (Network Attached Storage) uređaja u kućnoj mreži.



Televizor i računalo ili NAS uređaj moraju biti u istoj kućnoj mreži. Na računalu ili NAS uređaju trebate instalirati softver multimedijjskog poslužitelja. Multimedijjski poslužitelj mora biti postavljen na dijeljenje datoteka s televizorom. Televizor prikazuje datoteke i mape onako kako ih je organizirao multimedijjski poslužitelj ili kako su strukturirane na računalu ili NAS uređaju.

Televizor ne podržava titlove na videozapisima usmjerenim s računala ili NAS uređaja.

Ako multimedijjski poslužitelj podržava pretraživanje datoteka, polje za pretraživanje bit će dostupno.

Za pretraživanje i reprodukciju datoteka na računalu...

- 1 - Pritisnite  SOURCES, odaberite  Mreža i pritisnite OK.
- 2 - Odaberite  Jednostavno podijeli uređaje i





- pritisnite  (desno) za odabir željenog uređaja.
- 3 - Možete pretraživati i reproducirati svoje datoteke.
 - 4 - Za zaustavljanje reprodukcije videozapisa, fotografija i glazbe pritisnite  EXIT.

13.3

S usluge pohrane u oblaku

Možete prikazati fotografije ili reproducirati glazbu i videozapise koje ste prenijeli na uslugu pohrane u mrežnom oblaku*.

Uz aplikaciju  Cloud Explorer možete se povezati s uslugama pohrane u oblaku. Možete upotrijebiti svoje podatke za prijavu i lozinku za povezivanje.





- 1 - Pritisnite  HOME.
- 2 - Pomaknite se prema dolje i odaberite  Aplikacije >  Cloud Explorer i pritisnite OK.
- 3 - Odaberite željenu uslugu pohrane.
- 4 - Povežite se s uslugom pohrane i prijavite sa svojim podacima za prijavu i lozinkom.
- 5 - Odaberite fotografiju ili videozapis koji želite reproducirati i pritisnite OK.
- 6 - Pritisnite  (lijevo) za vraćanje jedan korak ili pritisnite  BACK za zatvaranje izbornika.

* Usluga pohrane kao što je Dropbox™.





13.4

Izbornici Omiljeni, Najpopularnije, Posljednje reproducirano





Pregled omiljenih datoteka

- 1 - Pritisnite  SOURCES, odaberite  USB i pritisnite OK.
- 2 - Odaberite  USB uređaji i odaberite  Omiljeni.
- 3 - Možete pregledavati omiljene datoteke na popisu.

Pregled najpopularnijih datoteka

- 1 - Pritisnite  SOURCES, odaberite  USB i pritisnite OK.
- 2 - Odaberite  USB uređaji i odaberite  Najpopularnije.
- 3 - Pritisnite OK kako biste pregledali datoteke s popisa ili pritisnite  OPTIONS kako biste očistili popis najpopularnijih.

Pregled posljednje reproduciranih datoteka

- 1 - Pritisnite  SOURCES, odaberite  USB i pritisnite OK.
- 2 - Odaberite  USB uređaji i odaberite  Posljednje reproducirano.
- 3 - Pritisnite OK kako biste pregledali

datoteke + OPTIONS kako biste očistili popis posljednje reproduciranih.

13.5

Reprodukcija vaših videozapisa

Kontrolna traka

Kako bi se tijekom reprodukcije videozapisa prikazala ili sakrila kontrolna traka, pritisnite **i** INFO* ili OK.

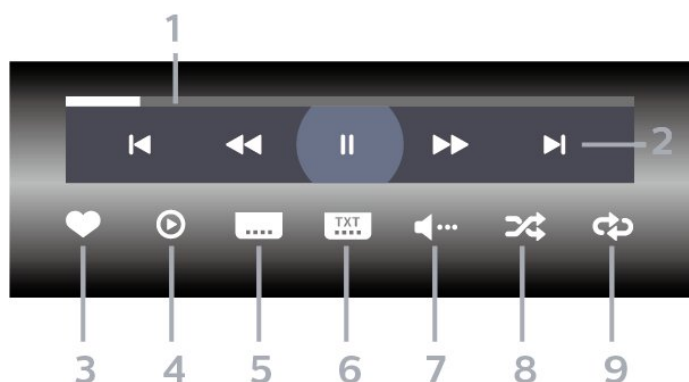

- 1 - Traka napretka
- 2 - Kontrolna traka za reprodukciju
 - ◀: Prijelaz na prethodni videozapis u mapi
 - ▶: Prijelaz na sljedeći videozapis u mapi
 - ⏮: Premotavanje unatrag
 - ⏭: Brzo premotavanje unaprijed
 - ||: Pauziranje reprodukcije

- 3 - Označavanje kao omiljeno
- 4 - Reprodukcija svih videozapisa
- 5 - Titl: postavljanje titlova na Uključeno, Isključeno ili Uključeno za vrijeme stišanog zvuka.
- 6 - Jezik titla: odabir jezika titla
- 7 - Audio jezik: odabir audio jezika
- 8 - Nasumično: reprodukcija datoteka nasumičnim redoslijedom
- 9 - Ponovi: reprodukcija svih videozapisa u mapi jednom ili kontinuirano

* Ako je na daljinskom upravljaču dostupna tipka **i** INFO

13.6

Gledanje vaših fotografija

Kontrolna traka

Kako bi se tijekom reprodukcije prikaza slajdova prikazala ili sakrila kontrolna traka, pritisnite **i** INFO* ili OK.

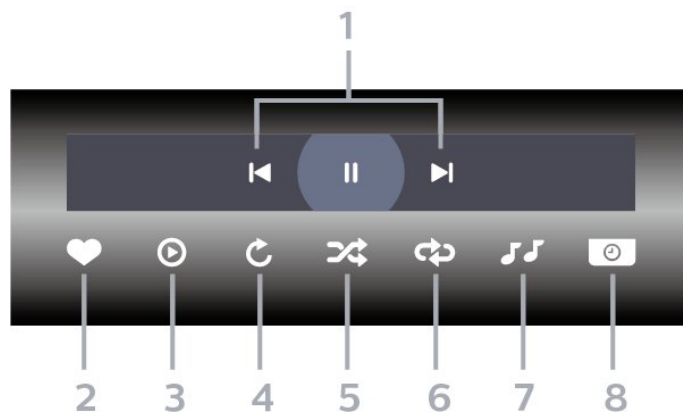

- 1 - Kontrolna traka za reprodukciju
- ◀: Prijelaz na prethodnu fotografiju u mapi
- ▶: Prijelaz na sljedeću fotografiju u mapi
- ||: Pauziranje reprodukcije prikaza slajdova

- 2 - Označavanje kao omiljeno
- 3 - Pokretanje prikaza slajdova
- 4 - Okretanje fotografije
- 5 - Nasumično: reprodukcija datoteka nasumičnim redoslijedom
- 6 - Ponovi: reprodukcija svih fotografija u mapi jednom ili kontinuirano
- 7 - Zaustavi glazbu: zaustavljanje glazbe koja se reproducira u pozadini.
- 8 - Postavljanje brzine prikaza slajdova

* Ako je na daljinskom upravljaču dostupna tipka **i** INFO

13.7

Reprodukcija glazbe

Kontrolna traka

Kako bi se tijekom reprodukcije glazbe prikazala ili sakrila kontrolna traka, pritisnite **i** INFO* ili OK.

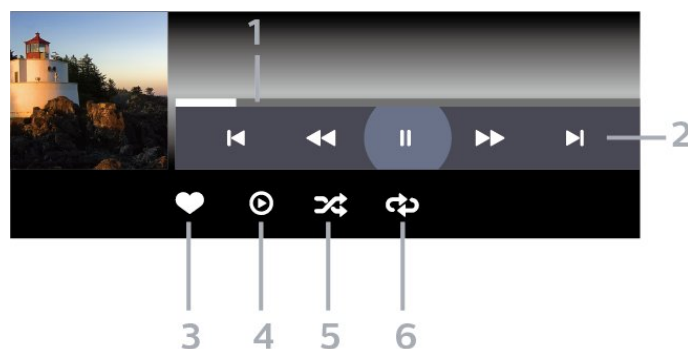

- 1 - Traka napretka
- 2 - Kontrolna traka za reprodukciju
- ◀: Prijelaz na prethodni glazbeni sadržaj u mapi
- ▶: Prijelaz na sljedeći glazbeni sadržaj u mapi
- ⏮: Premotavanje unatrag
- ⏭: Brzo premotavanje unaprijed
- ||: Pauziranje reprodukcije

- 3 - Označavanje kao omiljeno
- 4 - Reproducirajte svu glazbu
- 5 - Nasumično: reprodukcija datoteka nasumičnim redoslijedom
- 6 - Ponovi: reprodukcija sve glazbe u mapi jednom ili kontinuirano

* Ako je na daljinskom upravljaču dostupna tipka  INFO

TV vodič

14.1

Što je potrebno

TV vodič omogućava prikaz popisa trenutnih i zakazanih televizijskih programa vaših kanala. Ovisno o tome odakle dolaze informacije (podaci) TV vodiča, prikazuju se analogni i digitalni kanali ili samo digitalni kanali. Ne pružaju svi kanali informacije TV vodiča.

Televizor može prikupljati informacije TV vodiča za kanale instalirane na televizoru. Televizor ne može prikupljati informacije TV vodiča za kanale koji se gledaju putem digitalnog prijemnika ili dekodera.

14.2

Podaci TV vodiča

TV vodič prima informacije (podatke) od televizijskih kuća ili s interneta. U nekim regijama i za neke kanale, informacije TV vodiča možda neće biti dostupne. Televizor može prikupljati informacije TV vodiča za kanale instalirane na televizoru. Televizor ne može prikupljati informacije TV vodiča za kanale koji se gledaju putem digitalnog prijemnika ili dekodera.

Televizor se isporučuje sa zadanom opcijom **Od televizijske kuće**.

Ako informacije TV vodiča dolaze s interneta, TV vodič može prikazati popis analognih kanala uz digitalne. Izbornik TV vodiča prikazuje i mali zaslon s kanalom koji trenutno gledate.

S Interneta

Ako je televizor povezan s internetom, možete ga postaviti tako da informacije TV vodiča prima s interneta.

Postavljanje informacija TV vodiča...

- 1 - Pritisnite , odaberite **Sve postavke** i pritisnite **OK**.
- 2 - Odaberite **Općenite postavke** i pritisnite **➤** (desno) kako biste otvorili izbornik.
- 3 - Odaberite **Napredno > TV vodič > S interneta** i pritisnite **OK**.
- 4 - Po potrebi više puta pritisnite **◀** (lijevo) kako biste zatvorili izbornik.

Snimke koje nedostaju

Kada vam se učini da neke snimke nedostaju na popisu snimaka, moguće je da su se promijenile informacije (podaci) TV vodiča. Snimke snimljene uz postavku **Od televizijske kuće** postaju nevidljive na popisu ako postavku promijenite u **S Interneta** i obrnuto. Možda je televizor automatski prešao na

postavku **S Interneta**.

Kako bi snimke postale dostupne na popisu snimaka, odaberite postavku koja je bila odabrana u vrijeme snimanja.

14.3

Uporaba TV vodiča

Otvaranje TV vodiča

Kako biste otvorili TV vodič, pritisnite  **TV GUIDE**. TV vodič prikazat će kanale za odabrani tuner.

Ponovo pritisnite  **TV GUIDE** za zatvaranje.

Kada prvi put otvorite TV vodič, televizor će skenirati sve kanale tražeći informacije o programu. To može potrajati nekoliko minuta. Podaci TV vodiča spremaju se na televizor.

Prelazak na program

Iz TV vodiča možete prijeći na trenutni program.

Kako biste prešli na program (kanal), odaberite program i pritisnite **OK**.

Prikaz pojedinosti o programu

Za učitavanje pojedinosti odabranog programa...

- 1 - Pritisnite **+** **OPTIONS** i odaberite **Preference**.
- 2 - Odaberite **Informacije o kanalu** i pritisnite **OK**.
- 3 - Pritisnite **←** **BACK** kako biste zatvorili.

Promjena dana

TV vodič može prikazati zakazane programe za nadolazeće dane (najviše 8 dana).

- 1 - Pritisnite  **TV GUIDE**.
- 2 - Odaberite **Sada** i pritisnite **OK**.
- 3 - Odaberite dan koji vam je potreban.

Postavljanje podsjetnika

Možete postaviti podsjetnik za program. Poruka će vas podsjetiti na početak programa. Možete odabrati trenutno pokretanje tog programa.

U TV vodiču program s podsjetnikom označen je ikonom  (sat).

Postavljanje podsjetnika...

- 1 - Pritisnite  **TV GUIDE** i odaberite željeni program.
- 2 - Pritisnite **+** **OPTIONS**.
- 3 - Odaberite **Postavi podsjetnik** i pritisnite **OK**.

4 - Pritisnite **← BACK** kako biste zatvorili izbornik.

Brisanje podsjetnika...

1 - Pritisnite **≡ TV GUIDE** i odaberite program s podsjetnikom.

2 - Pritisnite **+ OPTIONS**.

3 - Odaberite **Očisti podsjetnik** i pritisnite **OK**.

4 - Pritisnite **← BACK** kako biste zatvorili izbornik.

Pretraga po žanru

Ako su informacije dostupne, zakazane programe možete potražiti po žanru, npr. filmovi, sport itd.

Pretraživanje programa prema žanru...

1 - Pritisnite **≡ TV GUIDE**.

2 - Navigacijskim tipkama u gornjem desnom kutu odaberite **⋮** i pritisnite **OK**.

3 - Odaberite **Pretraga po žanru** i pritisnite **OK**.

4 - Odaberite željeni žanr i pritisnite **OK**. Prikazat će se popis pronađenih programa.

5 - Pritisnite **← BACK** kako biste zatvorili izbornik.

Postavljanje snimanja

Možete postaviti snimanje pomoću TV vodiča*.

U TV vodiču, program koji je postavljen za snimanje označen je s **📺**.

Snimanje programa...

1 - Pritisnite **≡ TV GUIDE** i odaberite program koji je u tijeku ili će tek započeti.

2 - Pritisnite **+ OPTIONS** i odaberite **Snimi**.

3 - Pritisnite **← BACK** kako biste zatvorili izbornik.

* Više informacija potražite u poglavlju **Snimanje i pauziranje televizijskog programa**.

Snimanje i Pause TV

15.1

Snimanje

Što je potrebno

Možete snimiti emitirani sadržaj digitalne televizije i gledati ga poslije.

Za snimanje televizijskog programa treba vam...

- povezani USB tvrdi disk formatiran na ovom televizoru
- digitalni televizijski kanali instalirani na televizoru
- primanje informacija o kanalu za zaslonski TV vodič
- pouzdana postavka vremena. Ako sat na televizoru ručno ponovno postavite, snimanje možda neće uspjeti.

Snimati ne može dok koristite Pause TV.

S obzirom na provedbu propisa za autorska prava, neki pružatelji DVB usluga mogu aktivirati razna ograničenja putem tehnologije DRM (Digital Right Management – upravljanje digitalnim pravima). U slučaju emitiranja zaštićenih kanala, snimanje, valjanost snimanja ili broj prikaza mogu biti ograničeni. Snimanje bi moglo biti potpuno onemogućeno. Ako pokušate snimiti zaštićene prijenose ili reproducirati prijenos koji je istekao, mogla bi se prikazati obavijest o pogrešci.

Snimanje programa

Trenutno snimanje

Kako biste snimili program koji gledate, pritisnite **●** (snimanje) na daljinskom upravljaču. Snimanje će odmah započeti.

Kako biste zaustavili snimanje, pritisnite **■** (zaustavljanje).

Kad su dostupni podaci TV vodiča, program koji gledate snimat će se od trenutka kad pritisnete tipku za snimanje dok program ne završi. Ako podaci TV vodiča nisu dostupni, snimanje će trajati samo 30 minuta. Vrijeme završetka snimanja možete prilagoditi na popisu **Snimke**.

Zakaži snimanje

Snimanje nadolazećeg programa možete zakazati za danas ili za nekoliko dana od danas (maksimalno 8 dana). Televizor će koristiti podatke iz TV vodiča za pokretanje i zaustavljanje snimanja.

Snimanje programa...

- 1 - Pritisnite **☰** TV GUIDE.
- 2 - Pomoću navigacijskih tipki odaberite **Sada** i pritisnite **OK**.
- 3 - Odaberite **Sada**, **Kasnije**, **Sutra** ili dan koji želite i pritisnite **OK** ili **← BACK** kako biste zatvorili izbornik.
- 4 - Odaberite program koji želite snimiti, pritisnite **+ OPTIONS**, odaberite **● Snimi** i pritisnite **OK**. Snimanje programa je zakazano. Automatski će se prikazati upozorenje ako se snimanje preklapa s drugim. Ako želite da se program snima u vašoj odsutnosti, ne zaboravite televizor ostaviti u stanju pripravnosti, a USB tvrdi disk uključen.
- 5 - Pritisnite **← BACK** kako biste zatvorili izbornik.

Sukobi snimanja

Kad se dva zakazana snimanja vremenski preklapaju, dolazi do sukoba snimanja. Kako biste ga razriješili, možete promijeniti početno i završno vrijeme jednog ili obaju zakazanih snimanja.

Za promjenu početnog i završnog vremena zakazanog snimanja...

- 1 - Pritisnite **☰ SOURCES** i odaberite **● Snimke**.
- 2 - Na vrhu zaslona odaberite **⌚ Zakazani** i pritisnite **OK**.
- 3 - Na popisu zakazanih snimki i podsjetnika odaberite **Snimke** i pritisnite **OK** za prikaz samo zakazanih snimanja.
- 4 - Odaberite zakazano snimanje koje je u sukobu s drugim zakazanim snimanjem i pritisnite **+ OPTIONS**.
- 5 - Odaberite **Vremenska zona** i pritisnite **OK**.
- 6 - Odaberite početno ili završno vrijeme i promijenite ga pomoću tipki **▲** (gore) ili **▼** (dolje). Odaberite **Primijeni** i pritisnite **OK**.
- 7 - Pritisnite **← BACK** kako biste zatvorili izbornik.

Automatsko vremensko ograničenje

Možete postaviti vremensku marginu koju će televizor automatski dodati na kraj svakog zakazanog snimanja.







Za postavljanje vremenske margine automatskog zaustavljanja...

- 1 - Pritisnite **☰ SOURCES** i odaberite **● Snimke**.
- 2 - Navigacijskim tipkama odaberite **⋮** u gornjem desnom kutu i pritisnite **OK**.
- 3 - Odaberite **Automatsko vremensko ograničenje** i pritisnite **OK**.
- 4 - Pritisnite **▲** (gore) ili **▼** (dolje) i pritisnite **OK** da biste postavili vremensku marginu koja se automatski dodaje na kraj snimanja. Snimanju možete dodati do 45 minuta.
- 5 - Pritisnite **← BACK** kako biste zatvorili izbornik.

Ručno snimanje

Možete zakazati snimanje koje nije vezano uz TV program. Sami postavljate vrstu tunera, kanal i početno i završno vrijeme.









Za ručno zakazivanje snimanja...

- 1 - Pritisnite  SOURCES i odaberite  Snimke.
- 2 - Na vrhu zaslona odaberite  Zakazani .
- 3 - Navigacijskim tipkama u gornjem desnom kutu odaberite  i pritisnite OK.
- 4 - Odaberite Raspored i pritisnite OK.
- 5 - Odaberite tuner za snimanje i pritisnite OK.
- 6 - Odaberite kanal za snimanje i pritisnite OK.
- 7 - Odaberite dan za snimanje i pritisnite OK.
- 8 - Odaberite početno i završno vrijeme snimanja. Odaberite tipku i upotrijebite strelice  (gore) ili  (dolje) za postavljanje sati i minuta.
- 9 - Odaberite Zakaži i pritisnite OK da biste zakazali ručno snimanje.

Snimanje će se prikazati na popisu zakazanih snimki i podsjetnika.

Gledanje snimke

Gledanje snimke...

- 1 - Pritisnite  SOURCES i odaberite  Snimke.
- 2 - Na popisu snimki odaberite željenu snimku i pritisnite OK za početak gledanja.
- 3 - Možete upotrijebiti tipke  (pauza),  (reprodukcija),  (premotavanje),  (ubrzanje) ili  (zaustavljanje).
- 4 - Za povratak na gledanje televizije pritisnite  EXIT.

15.2

Pause TV

Što je potrebno

Možete pauzirati emitiranje digitalne televizije i nastaviti gledati kasnije.

Za pauziranje televizijskog programa treba vam...

- povezani USB tvrdi disk formatiran na ovom televizoru
- digitalni televizijski kanali instalirani na televizoru
- primanje informacija o kanalu za zaslonski TV vodič

Ako je USB tvrdi disk povezan i formatiran, televizor neprestano sprema emitirani sadržaj koji gledate. Kada prijedete na drugi kanal, očistit će se emitirani sadržaj prethodnog kanala. Isto će se dogoditi kada televizor postavite u stanje pripravnosti.



Značajku Pause TV ne možete koristiti tijekom



snimanja.

Kako biste pronašli više informacija, u izborniku Pomoć odaberite Ključne riječi i potražite USB tvrdi disk, instalacija ili Instalacija, USB tvrdi disk.

Pauziranje programa

Pauziranje i nastavak gledanja emitiranja...

- Kako biste pauzirali televizijski program, pritisnite  (pauza). Nakratko će se prikazati traka napretka na dnu ekrana.
- Kako bi se traka napretka ponovo prikazala, ponovo pritisnite  (pauza).
- Kako biste nastavili gledati, pritisnite  (reprodukcija).

Dok je traka napretka na zaslonu, pritisnite  (premotavanje unatrag) ili  (premotavanje unaprijed) kako biste odabrali mjesto od kojeg želite početi gledati pauzirani program. Kako biste promijenili brzinu, kontinuirano pritišćite te tipke.





Emitiranje možete pauzirati na najviše 90 minuta.

Kako biste se vratili na televizijski program u stvarnom vremenu, pritisnite  (zaustavljanje).

Ponovna reprodukcija

Budući da televizor sprema emitirani sadržaj koji gledate, obično ga možete ponovo reproducirati na nekoliko sekundi.

Ponovna reprodukcija trenutnog emitiranog sadržaja...

- 1 - Pritisnite  (pauziranje)
- 2 - Pritisnite  (premotavanje). Možete više puta pritisnuti  kako biste odabrali odakle želite početi gledati emitirani sadržaj koji ste pauzirali. Kako biste promijenili brzinu, kontinuirano pritišćite te tipke. U jednom ćete trenutku doći do početka pohrane emitiranog sadržaja ili maksimalnog vremena emitiranja.
- 3 - Pritisnite  (reprodukcija) za ponovno gledanje emitiranog sadržaja.
- 4 - Pritisnite  (zaustavljanje) za gledanje emitiranog sadržaja uživo.

Pametni telefoni i tableti

Philips TV Remote App

Nova aplikacija TV Remote App tvrtke Philips na vašem pametnom telefonu ili tabletu novi je prijatelj vašeg televizora.

TV Remote App omogućava upravljanje multimedijским sadržajima oko vas. Šaljite fotografije, glazbu ili videozapise na veliki zaslon televizora ili gledajte uživo bilo koji od televizijskih kanala na tabletu ili telefonu. Potražite sadržaj koji želite gledati u TV vodiču i pogledajte ga na telefonu ili televizoru. Pomoću aplikacije TV Remote App možete koristiti telefon kao daljinski upravljač.

Preuzmite TV Remote App tvrtke Philips u omiljenoj trgovini aplikacija već danas.

Aplikacija TV Remote App tvrtke Philips dostupna je za iOS i Android i besplatna je.

Google Cast

Što je potrebno

Ako aplikacija na vašem mobilnom uređaju ima Google Cast, možete je prikazati na ovom televizoru. Na mobilnoj aplikaciji potražite Google Cast ikonu. Možete koristiti svoj mobilni uređaj za upravljanje televizorom. Google Cast radi na uređajima sa sustavima Android i iOS.

Vaš mobilni uređaj mora biti povezan na istu Wi-Fi kućnu mrežu kao vaš televizor.

Aplikacije s uslugom Google Cast

Nove aplikacije s uslugom Google Cast postaju dostupne svaki dan. Već je možete isprobati s aplikacijama YouTube, Chrome, Netflix, Photowall... ili Big Web Quiz za Chromecast. Također pogledajte google.com/cast

Neki proizvodi i značajke usluge Google Play nisu dostupni u svim zemljama.

Više informacija potražite na support.google.com/androidtv

Prikazivanje na vašem televizoru

Za prikazivanje aplikacije na zaslonu televizora...

- 1 - Na pametnom telefonu ili tabletu otvorite aplikaciju koja podržava Google Cast.
- 2 - Dodirnite ikonu Google Cast.
- 3 - Odaberite televizor na kojemu želite prikazivati aplikaciju.
- 4 - Pritisnite reprodukciju na pametnom telefonu ili tabletu. Odabrana stavka trebala bi se prikazivati na televizoru.

AirPlay

Kako biste dodali funkcionalnost AirPlay svom Android TV-u, možete preuzeti i instalirati nekoliko aplikacija koje to čine. Nekoliko tih aplikacija možete pronaći u trgovini Google Play.

MHL

Ovaj televizor sukladan je sa standardom MHL™.

Ako je i vaš mobilni uređaj sukladan sa standardom MHL, možete ga povezati s televizorom putem MHL kabela. Kad je MHL kabel priključen, možete podijeliti sadržaj svog mobilnog uređaja na zaslonu televizora. Istovremeno se puni baterija vašeg mobilnog uređaja. MHL veza idealna je za gledanje filmova ili igranje igara s mobilnog uređaja na televizoru dulje vrijeme.

Punjenje

Kad je MHL kabel priključen, vaš uređaj će se puniti dok je televizor uključen (ne u stanju pripravnosti).

MHL kabel

Potreban vam je pasivni MHL kabel (HDMI na Micro USB) za povezivanje mobilnog uređaja s televizorom. Možda će vam biti potreban dodatni adapter za povezivanje s mobilnim uređajem. Za povezivanje MHL kabela s televizorom upotrijebite HDMI 4 MHL vezu.



MHL, Mobile High-Definition Link i logotip MHL zaštitni su znakovi ili registrirani zaštitni znakovi tvrtke MHL, LLC.

Igre

17.1

Što je potrebno

Na ovom televizoru možete igrati igre...

- iz galerije aplikacija u izborniku Početak
- iz trgovine Google Play u izborniku Početak
- s povezane igraće konzole

Igre iz galerije aplikacija ili trgovine Google Play potrebno je prvo preuzeti i instalirati na televizor da biste ih mogli igrati. Za igranje nekih igara potreban je upravljač.





Kako biste instalirali igre iz galerije aplikacija tvrtke Philips ili trgovine Google Play, televizor mora biti povezan s internetom. Morate prihvatiti odredbe uporabe kako biste mogli koristiti aplikacije iz galerije aplikacija. Morate se prijaviti s Google računom da biste mogli koristiti aplikacije usluge Google Play i trgovinu Google Play.

17.2

Igranje igre



Iz izbornika Početak

Za pokretanje igre iz izbornika Početak...

- 1 - Pritisnite  HOME.
- 2 - Pomaknite se prema dolje na  Igre , odaberite igru i pritisnite OK.
- 3 - Više puta pritisnite  BACK ili pritisnite  EXIT ili zaustavite aplikaciju pomoću njezine namjenske tipke za izlaz/zaustavljanje.

S igraće konzole

Za pokretanje igre s igraće konzole...

- 1 - Uključite igraću konzolu.
- 2 - Pritisnite  SOURCES i odaberite igraću konzolu ili naziv veze.
- 3 - Pokrenite igru.
- 4 - Više puta pritisnite  BACK ili pritisnite  EXIT ili zaustavite aplikaciju pomoću njezine namjenske tipke za izlaz/zaustavljanje.

Kako biste pronašli više informacija, u izborniku Pomoć odaberite Ključne riječi i potražite Igraća konzola, povezivanje.

Ambilight



Ambilight stil

Praćenje videozapisa

Možete podesiti Ambilight da prati video ili audio dinamiku televizijskog programa. Osim toga, možete podesiti Ambilight da prikazuje zadani stil boja ili ga isključiti.

Ako odaberete **Prati video**, možete odabrati jedan od stilova koji prate dinamiku slike na zaslonu televizora.

Postavljanje stila za Ambilight...

- 1 - Pritisnite  **AMBILIGHT**.
- 2 - Odaberite **Prati video**.
- 3 - Odaberite željeni stil.
- 4 - Pritisnite  (lijevo) za vraćanje jedan korak ili pritisnite  **BACK** za zatvaranje izbornika.

Dostupni stilovi za opciju **Prati video** su...



- **Standardno** – idealno za svakodnevno gledanje televizije
- **Prirodno** – prati sliku i zvuk što je vjernije moguće
- **Prožimajuće** – idealno za akcijske filmove
- **Živo** – idealno za gledanje tijekom dana
- **Igre** – idealno za igranje
- **Ugodno** – idealno za mirnu večer
- **Opušteno** – idealno za opuštanje

Praćenje zvuka

Možete podesiti Ambilight da prati video ili audio dinamiku televizijskog programa. Osim toga, možete podesiti Ambilight da prikazuje zadani stil boja ili ga isključiti.

Ako odaberete **Prati audio**, možete odabrati jedan od stilova koji prate dinamiku zvuka.

Postavljanje stila za Ambilight...

- 1 - Pritisnite  **AMBILIGHT**.
- 2 - Odaberite **Prati zvuk**.
- 3 - Odaberite željeni stil.
- 4 - Pritisnite  (lijevo) za vraćanje jedan korak ili pritisnite  **BACK** za zatvaranje izbornika.

Dostupni stilovi za opciju **Prati audio** su...

- **Svjetlo** – kombinacija zvučne dinamike i boja iz videozapisa
- **Boje** – na temelju zvučne dinamike
- **Retro** – na temelju zvučne dinamike
- **Spektar** – na temelju zvučne dinamike
- **Skener** – na temelju zvučne dinamike



- **Ritam** – na temelju zvučne dinamike
- **Zabava** – kombinacija svih navedenih zvučnih stilova, jednog za drugim

Prati boju

Možete podesiti Ambilight da prati video ili audio dinamiku televizijskog programa. Osim toga, možete podesiti Ambilight da prikazuje zadani stil boja ili ga isključiti.

Ako odaberete **Prati boju**, možete odabrati neku od postavljenih shema boja.

Postavljanje stila za Ambilight...

- 1 - Pritisnite  **AMBILIGHT**.
- 2 - Odaberite **Prati boju**.
- 3 - Odaberite željeni stil.
- 4 - Pritisnite  (lijevo) za vraćanje jedan korak ili pritisnite  **BACK** za zatvaranje izbornika.



Dostupni stilovi za opciju **Prati boju** su...

- **Vruća lava** – varijacije crvene boje
- **Duboka voda** – varijacije plave boje
- **Svježa priroda** – varijacije zelene boje
- **Topla bijela** – varijacije bijele boje
- **Hladna bijela** – statična boja

Prati aplikaciju



Ova funkcija je dostupna kada tehnologijom Ambilight upravljate aplikacijom.

Postavljanje stila za Ambilight...

- 1 - Pritisnite  **AMBILIGHT**.
- 2 - Odaberite **Prati aplikaciju**.
- 3 - Slijedite upute na zaslonu.
- 4 - Pritisnite  (lijevo) za vraćanje jedan korak ili pritisnite  **BACK** za zatvaranje izbornika.

Isključivanje funkcije Ambilight

Za isključivanje funkcije Ambilight...

- 1 - Pritisnite  **AMBILIGHT**.
- 2 - Odaberite **Isključeno**.
- 3 - Pritisnite  (lijevo) za vraćanje jedan korak ili pritisnite  **BACK** za zatvaranje izbornika.

Postavke funkcije Ambilight



Kako biste pronašli više informacija, u izborniku **Pomoć** odaberite **Ključne riječi** i potražite **Ambilight, postavke**.

Najpopularniji sadržaji

19.1

O najpopularnijim sadržajima

Uz  Preporuke, vaš televizor preporučuje...



- trenutni televizijski programi u izborniku  Sada na TV-u
- najnoviji videozapisi za posudbu u izborniku  Video na zahtjev
- usluge televizije na mreži (Catch Up TV) u izborniku  TV na zahtjev

Kako biste uživali u preporučenim sadržajima televizor povežite s internetom. Svakako prihvatite Odredbe uporabe. Informacije i usluge najpopularnijih sadržaja dostupne su samo u odabranim državama.

Odredbe uporabe

Kako bi televizor mogao davati preporuke, morate prihvatiti Odredbe uporabe. Kako biste dobili prilagođene preporuke na temelju navika gledanja provjerite jeste li označili potvrdni okvir **Prikazivanje prilagođenih preporuka za gledanje**.

Kako biste otvorili Odredbe uporabe...

- 1 - Pritisnite  TOP PICKS.
- 2 - Navigacijskim tipkama u gornjem desnom kutu odaberite , odaberite **Odredbe uporabe** i pritisnite **OK**.

19.2

Sada na TV-u

Više o opciji Sada na TV-u

Uz opciju  Sada na TV-u televizor preporučuje najpopularnije programe koje možete odmah gledati.

Preporučeni programi biraju se među instaliranim kanalima. Odabir obuhvaća kanale vaše države. Osim toga, opcija Sada na TV-u može vam ponuditi prilagođene preporuke na temelju programa koje redovito gledate.



Priprema za uporabu informacija opcije Sada na TV-u...

- Informacije opcije Sada na TV-u moraju biti dostupne u vašoj državi.
- Kanali moraju biti instalirani na televizoru.
- Televizor mora biti povezan s internetom.
- Sat televizora mora biti postavljen na Automatski ili Ovisno o državi.

- Morate prihvatiti Odredbe uporabe (možda ste ih već prihvatili prilikom povezivanja s internetom).

Uporaba opcije Sada na TV-u

Otvaranje opcije Sada na TV-u...

- 1 - Pritisnite  TOP PICKS kako biste otvorili izbornik Najpopularniji sadržaji.
- 2 - Odaberite  Sada na TV-u na vrhu zaslona i pritisnite **OK**.
- 3 - Odaberite **Više** kako biste otvorili TV vodič.

Kada otvorite Sada na TV-u, televizoru može trebati nekoliko sekundi da osvježi informacije stranice.

19.3

TV na zahtjev

Više o usluzi TV na zahtjev



Usluga  TV na zahtjev omogućava gledanje televizijskih programa koje ste propustili ili gledanje omiljenih programa kada vam to odgovara. Ova usluga zove se i Catch Up TV, Replay TV ili Online TV. Programi dostupni u sklopu usluge TV na zahtjev besplatni su.

Usluzi TV na zahtjev možete dopustiti da vam daje prilagođene preporuke za programe na temelju instalacije televizora i programa koje redovito gledate.



Ikona  prikazat će se na vrhu zaslona samo kada je dostupna usluga TV na zahtjev.

Uporaba usluge TV na zahtjev

Otvaranje usluge TV na zahtjev...

- 1 - Pritisnite  TOP PICKS kako biste otvorili izbornik Najpopularniji sadržaji.
- 2 - Odaberite  TV na zahtjev na vrhu zaslona i pritisnite **OK**.
- 3 - Odaberite **Svi prijenosi** i pritisnite **OK**. Možete odabrati određenu televizijsku kuću ako ih je više dostupno.
- 4 - Pritisnite  BACK kako biste zatvorili.

Kada otvorite TV na zahtjev, televizoru može trebati nekoliko sekundi da osvježi informacije stranice.

Nakon početka programa možete upotrijebiti tipke  (reprodukcija) i  (pauza).

Video na zahtjev

Više o usluzi Video na zahtjev

Usluga  Video na zahtjev omogućuje posuđivanje filmova iz trgovine videosadržaja na mreži.

Usluzi Video na zahtjev možete dopustiti da vam daje prilagođene preporuke za filmove na temelju vaše države, instalacije televizora i programa koje redovito gledate.

Ikona  prikazat će se na vrhu zaslona samo kada je dostupna usluga Video na zahtjev.

Plaćanje



Prilikom posuđivanja ili kupnje filma trgovini videosadržaja sigurno možete platiti kreditnom karticom. Većina trgovina videosadržaja zatražit će izradu računa za prijavu prilikom prve posudbe filma.

Internetski promet

Usmjeravanje velikog broja videozapisa može dovesti do prekoračenja mjesečnog ograničenja internetskog prometa.

Uporaba usluge Video na zahtjev



Otvaranje usluge Video na zahtjev...

- 1 - Pritisnite  TOP PICKS kako biste otvorili izbornik Najpopularniji sadržaji.
- 2 - Odaberite  Video na zahtjev na vrhu zaslona i pritisnite OK.
- 3 - Odaberite Sve trgovine, Preporučeno ili Popularno za preference.
- 4 - Pritisnite  BACK kako biste zatvorili.

Kada otvorite Video na zahtjev, televizoru može trebati nekoliko sekundi da osvježi informacije stranice.

Možete odabrati određenu trgovinu videosadržaja ako ih je više dostupno.

Posuđivanje filma...

- 1 - Pomaknite se do istaknutog dijela na filmskom posteru. Nakon nekoliko sekundi prikazat će se ograničene informacije.
- 2 - Pritisnite OK kako biste otvorili stranicu filma iz trgovine videosadržaja radi prikaza kratkog sadržaja filma.
- 3 - Potvrdite narudžbu.
- 4 - Izvršite plaćanje na televizoru.
- 5 - Počnite gledati. Možete koristiti tipke  (reprodukcija) i  (pauza).

Netflix

Ako imate pretplatu na Netflix, možete uživati u usluzi Netflix na ovom televizoru. Televizor mora biti povezan s internetom. U vašoj će regiji Netflix možda biti dostupan tek nakon budućih nadogradnji softvera.

Da biste otvorili Netflix, pritisnite **NETFLIX** za otvaranje aplikacije Netflix. Možete odmah otvoriti Netflix s televizora u stanju pripravnosti.

www.netflix.com



Multi View

21.1

Teletekst i TV

Možete gledati televizijski kanal u malom zaslonu značajke Multi View dok čitate teletekst.

Gledanje televizijskog kanala tijekom čitanja teleteksta...

- 1 - Pritisnite  Multi View * ili pritisnite  kako biste otvorili Izbornik televizora.
- 2 - Odaberite Multi View i pritisnite OK.
- 3 - Odaberite Multi View: Uključeno na zaslonu. Kanal koji gledate prikazat će se u malom zaslonu.

Kako biste sakrili mali zaslon, odaberite **Multi View: Isključeno** na zaslonu.



* Ako je na daljinskom upravljaču dostupna tipka  Multi View

21.2

HDMI i televizor

Možete gledati televizijski kanal u malom zaslonu značajke Multi View dok gledate videozapis s povezanog HDMI uređaja.

Gledanje televizijskog kanala tijekom gledanja videozapisa s povezanog HDMI uređaja*....

- 1 - Pritisnite  Multi View * ili pritisnite  kako biste otvorili Izbornik televizora.
- 2 - Odaberite Multi View i pritisnite OK.
- 3 - Odaberite Multi View: Uključeno na zaslonu. Kanal koji gledate prikazat će se u malom zaslonu.

Kako biste sakrili mali zaslon, odaberite **Multi View: Isključeno** na zaslonu.

Napomena: U načinu rada za Multi view možete gledati sliku televizijskog kanala, a zvuk televizijskog kanala je stišan.

* Ako je na daljinskom upravljaču dostupna tipka  Multi View

21.3

Nettv i televizija

Možete gledati televizijski kanal u malom zaslonu značajke Multi View dok gledate aplikaciju Nettv u Galeriji aplikacija.

Gledanje televizijskog kanala tijekom gledanja aplikacijeNettv u Galeriji aplikacija*...



- 1 - Pritisnite  Multi View * ili pritisnite  kako

biste otvorili Izbornik televizora.

2 - Odaberite Multi View i pritisnite OK.

3 - Odaberite Multi View: Uključeno na zaslonu.

Kanal koji gledate prikazat će se u malom zaslonu.

4 - Pritisnite  + ili  - za prebacivanje kanala u malom zaslonu

Kako biste sakrili mali zaslon, odaberite **Multi View: Isključeno** na zaslonu.



Napomena: Sve aplikacije Nettv ne podržavaju značajku Multi View uz televizijski kanal. Ako aplikacija ne podržava značajku Multi View, na televizoru prikazuje se poruka: **Multi View nije podržan.**

* Ako je na daljinskom upravljaču dostupna tipka  Multi View

21.4

Nettv i HDMI

Možete gledati aplikaciju Nettv u Galeriji aplikacija na malom zaslonu značajke Multi View dok gledate videozapis iz povezanog HDMI uređaja.

- 1 - Pritisnite  Multi View * ili pritisnite  kako biste otvorili Izbornik televizora.
- 2 - Odaberite Multi View i pritisnite OK.
- 3 - Odaberite Multi View: Uključeno na zaslonu.

Kako biste sakrili mali zaslon, odaberite **Multi View: Isključeno** na zaslonu.

Napomena: Sve aplikacije Nettv ne podržavaju značajku Multi View uz televizijski kanal. Ako aplikacija ne podržava značajku Multi View, na televizoru prikazuje se poruka: **Multi View nije podržan.**

* Ako je na daljinskom upravljaču dostupna tipka  Multi View

Softver

22.1

Ažuriraj softver

Ažuriranje putem interneta

Ako je televizor povezan s internetom, možda će se prikazati poruka za ažuriranje softvera televizora. Treba vam brza (širokopojasna) internetska veza. Ako primite takvu poruku, preporučujemo da izvršite ažuriranje.

Dok je poruka na zaslonu, odaberite **Ažuriraj** i slijedite upute na zaslonu.

Također možete sami potražiti ažuriranje softvera.

Tijekom ažuriranja softvera nema slike i televizor će se uključivati i isključivati. To se može dogoditi nekoliko puta. Ažuriranje može potrajati nekoliko minuta. Pričekajte dok se ne vrati slika na televizoru. Ne pritišćite gumb za uključivanje **⏻** na televizoru ili daljinskom upravljaču tijekom ažuriranja softvera.

Ručno traženje ažuriranja softvera...

- 1 - Pritisnite **⚙️**, odaberite **Sve postavke** i pritisnite **OK**.
- 2 - Odaberite **Ažuriraj softver > Traži ažuriranja**.
- 3 - Odaberite **Internet**.
- 4 - Televizor će potražiti ažuriranje na internetu.
- 5 - Ako je ažuriranje dostupno, možete odmah ažurirati softver.
- 6 - Ažuriranje softvera može potrajati nekoliko minuta. Ne pritišćite tipku **⏻** na televizoru ili daljinskom upravljaču.
- 7 - Kad ažuriranje završi, televizor će se vratiti na kanal koji ste gledali.

Ažuriranje pomoću USB uređaja

Možda će biti potrebno ažurirati softver televizora.

Treba vam računalo s brzom internetskom vezom i USB flash pogon pomoću kojeg ćete softver prenijeti na televizor. Koristite USB flash pogon s 500 MB slobodnog prostora. Provjerite je li isključena zaštita od zapisivanja.

Ažuriranje softvera televizora...

- 1 - Pritisnite **⚙️**, odaberite **Sve postavke** i pritisnite **OK**.
- 2 - Odaberite **Ažuriraj softver > Traži ažuriranja**.
- 3 - Odaberite **USB** i pritisnite **OK**.

Identifikacija televizora

- 1 - Priključite USB flash pogon u jednu od USB priključnica na televizoru.

- 2 - Odaberite **Piši na USB** i pritisnite **OK**. Identifikacijska datoteka upisat će se na USB flash pogon.

Preuzimanje softvera

- 1 - Umetnite USB flash pogon u računalo.
- 2 - Na USB flash pogonu pronađite datoteku **update.htm** i dvaput je pritisnite.
- 3 - Pritisnite **Pošalji ID**.
- 4 - Ako je novi softver dostupan, preuzmite **.zip** datoteku.
- 5 - Nakon preuzimanja raspakirajte datoteku i kopirajte datoteku **autorun.upg** na USB flash pogon. Tu datoteku nemojte stavljati u mapu.

Ažuriranje softvera televizora

- 1 - Ponovo priključite USB flash pogon u televizor. Ažuriranje će se automatski pokrenuti.
- 2 - Ažuriranje softvera može potrajati nekoliko minuta. Ne pritišćite tipku **⏻** na televizoru ili daljinskom upravljaču. Ne uklanjajte USB flash pogon.
- 3 - Kad ažuriranje završi, televizor će se vratiti na kanal koji ste gledali.

Ako tijekom ažuriranja dođe do prekida napajanja, nemojte vaditi USB flash pogon iz televizora. Kada se napajanje vrati, televizor će nastaviti s ažuriranjem.

Kako biste spriječili slučajno ažuriranje softvera televizora, izbrišite datoteku **autorun.upg** s USB flash pogona.

22.2

Verzija softvera

Prikaz trenutne verzije softvera televizora...

- 1 - Pritisnite **⚙️**, odaberite **Sve postavke** i pritisnite **OK**.
- 2 - Odaberite **Ažuriraj softver > Podaci o tekućem softveru** i pritisnite **OK**.
- 3 - Prikazuju se verzija, napomene o izdanju i datum izrade. Također se prikazuje Netflix ESN broj ako je dostupan.
- 4 - Po potrebi više puta pritisnite **⬅️** (lijevo) kako biste zatvorili izbornik.

22.3

Softver otvorenog koda

Ovaj televizor ima softver otvorenog koda. TP Vision Europe B.V. ovim putem nudi da na zahtjev isporuči potpun odgovarajući izvorni kôd za pakete softvera otvorenog koda zaštićene autorskim pravima koji se koriste u ovom proizvodu, ako je takav zahtjev sadržan u odgovarajućim licencama.

Ponuda vrijedi za sve primatelje ove informacije najduže tri godine nakon kupnje proizvoda. Kako biste dobili izvorni kôd, obratite se na engleskom jeziku na adresu . . .

Licenca za otvoreni kod

O licenci za otvoreni kod

README datoteka za izvorni kôd dijelova softvera za televizor tvrtke TP Vision Netherlands B.V. obuhvaćen licencama za otvoreni kôd.

To je dokument koji opisuje distribuciju izvornog koda koji se koristi u televizoru tvrtke TP Vision Netherlands B.V., a pripada licenci GNU General Public License (GPL) ili GNU Lesser General Public License (LGPL), ili bilo kojoj drugoj licenci za softver otvorenog koda. Upute o dobivanju kopija ovog softvera možete pronaći u uputama za uporabu.

TP Vision Netherlands B.V. NE DAJE NIKAKVA JAMSTVA, BILO IZRIČITA ILI PODRAZUMIJEVANA, UKLJUČUJUĆI BILO KOJA JAMSTVA MOGUĆNOSTI PRODAJE ILI PRIMJERENOSTI ZA ODREĐENU SVRHU KOJA SE TIČU OVOG SOFTVERA. TP Vision Netherlands B.V. ne pruža podršku za ovaj softver. Navedeno ne utječe na vaša jamstva i zakonska prava s obzirom na bilo koji proizvod tvrtke TP Vision Netherlands B.V. koji ste kupili. Odnosi se samo na ovaj izvorni kod koji vam je dat na raspolaganje.

Open Source

Android (5.1.0)

This TV contains the Android Lollipop Software. Android is a Linux-based operating system designed primarily for touch screen mobile devices such as smartphones and tablet computers. This software will also be reused in TPVision Android based TV's. The original download site for this software is :

<https://android.google.com> This piece of software is made available under the terms and conditions of the Apache license version 2, which can be found below. Android APACHE License Version 2 (<http://source.android.com/source/licenses.html>)

Toolbox (N/A)

The original download site for this software is : <https://android.google.com> This piece of software is made available under the terms and conditions of the Apache license version 2, which can be found below. Android APACHE License Version 2 (<http://source.android.com/source/licenses.html>)

linux kernel (3.10.27)

This TV contains the Linux Kernel. The original download site for this software is :

<http://www.kernel.org/>. This piece of software is made available under the terms and conditions of the GPL v2 license, which can be found below. Additionally, following exception applies : "NOTE! This copyright does *not* cover user programs that use kernel services by normal system calls - this is merely considered normal use of the kernel, and does *not* fall under the heading of "derived work". Also note that the GPL below is copyrighted by the Free Software Foundation, but the instance of code that it refers to (the linux kernel) is copyrighted by me and others who actually wrote it. Also note that the only valid version of the GPL as far as the kernel is concerned is `_this_` particular version of the license (ie v2, not v2.2 or v3.x or whatever), unless explicitly otherwise stated. Linus Torvalds"

libcurl (7.21.7)

libcurl is a free and easy-to-use client-side URL transfer library, supporting DICT, FILE, FTP, FTPS, Gopher, HTTP, HTTPS, IMAP, IMAPS, LDAP, LDAPS, POP3, POP3S, RTMP, RTSP, SCP, SFTP, SMTP, SMTPS, Telnet and TFTP. libcurl supports SSL certificates, HTTP POST, HTTP PUT, FTP uploading, HTTP form based upload, proxies, cookies, user+password authentication (Basic, Digest, NTLM, Negotiate, Kerberos), file transfer resume, http proxy tunneling and more! The original download site for this software is :

[http://curl.haxx.se/libcurl/COPYRIGHT AND PERMISSION NOTICE](http://curl.haxx.se/libcurl/COPYRIGHT%20AND%20PERMISSION%20NOTICE)

Copyright (c) 1996 - 2010, Daniel Stenberg, daniel@haxx.se. All rights reserved. Permission to use, copy, modify, and distribute this software for any purpose with or without fee is hereby granted, provided that the above copyright notice and this permission notice appear in all copies. THE SOFTWARE IS PROVIDED "AS IS", WITHOUT WARRANTY OF ANY KIND, EXPRESS OR IMPLIED, INCLUDING BUT NOT LIMITED TO THE WARRANTIES OF MERCHANTABILITY, FITNESS FOR A PARTICULAR PURPOSE AND NONINFRINGEMENT OF THIRD PARTY RIGHTS. IN NO EVENT SHALL THE AUTHORS OR COPYRIGHT HOLDERS BE LIABLE FOR ANY CLAIM, DAMAGES OR OTHER LIABILITY, WHETHER IN AN ACTION OF CONTRACT, TORT OR OTHERWISE, ARISING FROM, OUT OF OR IN CONNECTION WITH THE SOFTWARE OR THE USE OR OTHER DEALINGS IN THE SOFTWARE. Except as contained in this notice, the name of a copyright holder shall not be used in advertising or otherwise to promote the sale, use or other dealings in this Software without prior written authorization of the copyright holder.

libfreetype (2.4.2)

FreeType is a software development library, available in source and binary forms, used to render text on to bitmaps and provides support for other font-related operations

The original download site for this software is : <https://github.com/julienr/libfreetype-androidFreetype>
License

libjpeg (8a)

This package contains C software to implement JPEG image encoding, decoding, and transcoding. This software is based in part on the work of the Independent JPEG Group.

The authors make NO WARRANTY or representation, either express or implied, with respect to this software, its quality, accuracy, merchantability, or fitness for a particular purpose. This software is provided "AS IS", and you, its user, assume the entire risk as to its quality and accuracy. This software is copyright (C) 1991-1998, Thomas G. Lane. All Rights Reserved except as specified below. Permission is hereby granted to use, copy, modify, and distribute this software (or portions thereof) for any purpose, without fee, subject to these conditions:(1) If any part of the source code for this software is distributed, then this README file must be included, with this copyright and no-warranty notice unaltered; and any additions, deletions, or changes to the original files must be clearly indicated in accompanying documentation.(2) If only executable code is distributed, then the accompanying documentation must state that "this software is based in part on the work of the Independent JPEG Group".(3) Permission for use of this software is granted only if the user accepts full responsibility for any undesirable consequences; the authors accept NO LIABILITY for damages of any kind. These conditions apply to any software derived from or based on the IJG code, not just to the unmodified library. If you use our work, you ought to acknowledge us. Permission is NOT granted for the use of any IJG author's name or company name in advertising or publicity relating to this software or products derived from it. This software may be referred to only as "the Independent JPEG Group's software". We specifically permit and encourage the use of this software as the basis of commercial products, provided that all warranty or liability claims are assumed by the product vendor.

libpng (1.4.1)

libpng is the official Portable Network Graphics (PNG) reference library (originally called pnglib). It is a platform-independent library that contains C functions for handling PNG images. It supports almost all of PNG's features, is extensible. The original download site for this software is : <https://github.com/julienr/libpng-androidlibpng>
license

openssl (1.0.1j)

OpenSSL is an open-source implementation of the SSL and TLS protocols. The core library, written in the C programming language, implements the basic cryptographic functions and provides various utility

functions. The original download site for this software is : <http://openssl.org/OpenSSL> license

Zlib compression library (1.2.7)

zlib is a general purpose data compression library. All the code is thread safe. The data format used by the zlib library is described by RFCs (Request for Comments) 1950 to 1952 in the files <http://tools.ietf.org/html/rfc1950> (zlib format), rfc1951 (deflate format) and rfc1952 (gzip format) Developed by Jean-loup Gailly and Mark Adler(C) 1995-2012 Jean-loup Gailly and Mark Adler This software is provided 'as-is', without any express or implied warranty. In no event will the authors be held liable for any damages arising from the use of this software. Permission is granted to anyone to use this software for any purpose, including commercial applications, and to alter it and redistribute it freely, subject to the following restrictions: 1. The origin of this software must not be misrepresented; you must not claim that you wrote the original software. If you use this software in a product, an acknowledgment in the product documentation would be appreciated but is not required. 2. Altered source versions must be plainly marked as such, and must not be misrepresented as being the original software. 3. This notice may not be removed or altered from any source distribution. Jean-loup Gailly Mark Adler jloup@gzip.org madler@alumni.caltech.edu

dvbsnoop (1.2)

dvbsnoop is a DVB / MPEG stream analyzer program. For generating CRC32 values required for composing PAT, PMT, EIT sections

The original download site for this software is : <https://github.com/a4tunado/dvbsnoop/blob/master/src/misc/crc32.c> GPL v2
<http://dvbsnoop.sourceforge.net/dvbsnoop.html>

ezxml (0.8.6)

ezXML is a C library for parsing XML documents.

The original download site for this software is : <http://ezxml.sourceforge.net>. Copyright 2004, 2005 Aaron Voisine. This piece of software is made available under the terms and conditions of the MIT license, which can be found below.

gSoap (2.7.15)

The gSOAP toolkit is an open source C and C++ software development toolkit for SOAP/XML Web services and generic (non-SOAP) C/C++ XML data bindings. Part of the software embedded in this product is gSOAP software. Portions created by gSOAP are Copyright 2001-2009 Robert A. van Engelen, Genivia inc. All Rights Reserved. THE SOFTWARE IN THIS PRODUCT WAS IN PART PROVIDED BY GENIVIA INC AND ANY EXPRESS OR IMPLIED WARRANTIES, INCLUDING, BUT NOT LIMITED TO, THE IMPLIED WARRANTIES OF

MERCHANTABILITY AND FITNESS FOR A PARTICULAR PURPOSE ARE DISCLAIMED. IN NO EVENT SHALL THE AUTHOR BE LIABLE FOR ANY DIRECT, INDIRECT, INCIDENTAL, SPECIAL, EXEMPLARY, OR CONSEQUENTIAL DAMAGES (INCLUDING, BUT NOT LIMITED TO, PROCUREMENT OF SUBSTITUTE GOODS OR SERVICES; LOSS OF USE, DATA, OR PROFITS; OR BUSINESS INTERRUPTION) HOWEVER CAUSED AND ON ANY THEORY OF LIABILITY, WHETHER IN CONTRACT, STRICT LIABILITY, OR TORT (INCLUDING NEGLIGENCE OR OTHERWISE) ARISING IN ANY WAY OUT OF THE USE OF THIS SOFTWARE, EVEN IF ADVISED OF THE POSSIBILITY OF SUCH DAMAGE.

restlet (2.1.7)

Restlet is a lightweight, comprehensive, open source REST framework for the Java platform. Restlet is suitable for both server and client Web applications. It supports major Internet transport, data format, and service description standards like HTTP and HTTPS, SMTP, XML, JSON, Atom, and WADL. The original download site for this software is :

<http://restlet.org>This piece of software is made available under the terms and conditions of the Apache License version 2.

Opera Web Browser (SDK 3.5)

This TV contains Opera Browser Software.

dlmalloc (2.7.2)

Opera uses Doug Lea's memory allocator

The original download site for this software is :
<http://gee.cs.oswego.edu/dl/html/malloc.html>

double-conversion

Opera uses double-conversion library by Florian Loitsch, faster double : string conversions (dtoa and strtod).The original download site for this software is :
<http://code.google.com/p/double-conversion/>Copyright 2006-2011, the V8 project authors. All rights reserved. Redistribution and use in source and binary forms, with or without modification, are permitted provided that the following conditions are met: * Redistributions of source code must retain the above copyright notice, this list of conditions and the following disclaimer. * Redistributions in binary form must reproduce the above copyright notice, this list of conditions and the following disclaimer in the documentation and/or other materials provided with the distribution. * Neither the name of Google Inc. nor the names of its contributors may be used to endorse or promote products derived from this software without specific prior written permission. THIS SOFTWARE IS PROVIDED BY THE COPYRIGHT HOLDERS AND CONTRIBUTORS "AS IS" AND ANY EXPRESS OR IMPLIED WARRANTIES, INCLUDING, BUT NOT LIMITED TO, THE IMPLIED WARRANTIES OF

MERCHANTABILITY AND FITNESS FOR A PARTICULAR PURPOSE ARE DISCLAIMED. IN NO EVENT SHALL THE COPYRIGHTOWNER OR CONTRIBUTORS BE LIABLE FOR ANY DIRECT, INDIRECT, INCIDENTAL, SPECIAL, EXEMPLARY, OR CONSEQUENTIAL DAMAGES (INCLUDING, BUT NOT LIMITED TO, PROCUREMENT OF SUBSTITUTE GOODS OR SERVICES; LOSS OF USE, DATA, OR PROFITS; OR BUSINESS INTERRUPTION) HOWEVER CAUSED AND ON ANY THEORY OF LIABILITY, WHETHER IN CONTRACT, STRICT LIABILITY, OR TORT (INCLUDING NEGLIGENCE OR OTHERWISE) ARISING IN ANY WAY OUT OF THE USE OF THIS SOFTWARE, EVEN IF ADVISED OF THE POSSIBILITY OF SUCH DAMAGE.

EMX (0.9c)

Opera uses EMX, which is an OS/2 port of the gcc suite. Opera uses modified versions of the printf and scanf methods from this C library.* The emx libraries are not distributed under the GPL. Linking an * application with the emx libraries does not cause the executable * to be covered by the GNU General Public License. You are allowed * to change and copy the emx library sources if you keep the copyright * message intact. If you improve the emx libraries, please send your * enhancements to the emx author (you should copyright your * enhancements similar to the existing emx libraries).

freetype (2.4.8)

Opera uses freetype FreeType 2 is a software-font engine that is designed to be small, efficient, highly customizable and portable, while capable of producing high-quality output (glyph images).The original download site for this software is : <http://www.freetype.org/freetype2/index.html>Freetype License

HKSCS (2008)

Opera uses HKSCS: The Government of the Hong Kong Special Administrative Region HKSCS mappingsThe original download site for this software is : <http://www.ogcio.gov.hk>Before downloading the Software or Document provided on this Web page, you should read the following terms (Terms of Use). By downloading the Software and Document, you are deemed to agree to these terms.1. The Government of the Hong Kong Special Administrative Region (HKSARG) has the right to amend or vary the terms under this Terms of Use from time to time at its sole discretion.2. By using the Software and Document, you irrevocably agree that the HKSARG may from time to time vary this Terms of Use without further notice to you and you also irrevocably agree to be bound by the most updated version of the Terms of Use.3. You have the sole responsibility of obtaining the most updated version of the Terms of Use which is available in the "Digital 21" Web site (http://www.ogcio.gov.hk/en/business/tech_promotion/ccli/terms/terms.htm).4. By accepting this Terms of Use, HKSARG

shall grant you a non-exclusive license to use the Software and Document for any purpose, subject to clause 5 below.5. You are not allowed to make copies of the Software and Document except it is incidental to and necessary for the normal use of the Software. You are not allowed to adapt or modify the Software and Document or to distribute, sell, rent, or make available to the public the Software and Document, including copies or an adaptation of them.6. The Software and Document are protected by copyright. The licensors of the Government of Hong Kong Special Administrative Region are the owners of all copyright works in the Software and Document. All rights reserved.7. You understand and agree that use of the Software and Document are at your sole risk, that any material and/or data downloaded or otherwise obtained in relation to the Software and Document is at your discretion and risk and that you will be solely responsible for any damage caused to your computer system or loss of data or any other loss that results from the download and use of the Software and Document in any manner whatsoever.8. In relation to the Software and Document, HKSARG hereby disclaims all warranties and conditions, including all implied warranties and conditions of merchantability, fitness for a particular purpose and non-infringement.9. HKSARG will not be liable for any direct, indirect, incidental, special or consequential loss of any kind resulting from the use of or the inability to use the Software and Document even if HKSARG has been advised of the possibility of such loss.10. You agree not to sue HKSARG and agree to indemnify, defend and hold harmless HKSARG, its officers and employees from any and all third party claims, liability, damages and/or costs (including, but not limited to, legal fees) arising from your use of the Software and Document, your violation of the Terms of Use or infringement of any intellectual property or other right of any person or entity.11. The Terms of Use will be governed by and construed in accordance with the laws of Hong Kong.12. Any waiver of any provision of the Terms of Use will be effective only if in writing and signed by HKSARG or its representative.13. If for any reason a court of competent jurisdiction finds any provision or portion of the Terms of Use to be unenforceable, the remainder of the Terms of Use will continue in full force and effect.14. The Terms of Use constitute the entire agreement between the parties with respect to the subject matter hereof and supersedes and replaces all prior or contemporaneous understandings or agreements, written or oral, regarding such subject matter.15. In addition to the licence granted in Clause 4, HKSARG hereby grants you a non-exclusive limited licence to reproduce and distribute the Software and Document with the following conditions:(i) not for financial gain unless it is incidental;(ii) reproduction and distribution of the Software and Document in complete and unmodified form; and(iii) when you distribute the Software and

Document, you agree to attach the Terms of Use and a statement that the latest version of the Terms of Use is available from the "Office of the Government Chief Information Officer" Web site (http://www.ogcio.gov.hk/en/business/tech_promotion/ccli/terms/terms.htm).

IANA (Dec 30 2013)

Opera uses Internet Assigned Numbers Authority: Character encoding tag names and numbers. The original download site for this software is : <https://www.iana.org>

ICU (3)

Opera uses ICU : International Components for Unicode: Mapping table for GB18030The original download site for this software is : <http://site.icu-project.org/http://source.icu-project.org/repos/icu/icu/trunk/license.html>

MozTW (1.0)

Opera uses MoxTW : MozTW project: Big5-2003 mapping tables. The original download site for this software is : <https://moztw.org>This piece of software is made available under the terms and conditions of CCPL

NPAPI (0.27)

Opera uses NPAPI : Netscape 4 Plugin API: npapi.h, npfunctions.h, npruntime.h and nptypes.h. Distributed as part of the Netscape 4 Plugin SDK.The original download site for this software is : wiki.mozilla.orgThis piece of software is made available under the terms and conditions of mozilla licence as described below.

Unicode (4.0)

Opera uses Unicode : Data from the Unicode character database. The original download site for this software is : www.unicode.org/http://www.unicode.org/copyright.html

Webp (0.2.0)

Opera uses Webp : libwebp is a library for decoding images in the WebP format. Products may use it to decode WebP images. The turbo servers will eventually re-decode images to WebP. The original download site for this software is : <https://developers.google.com/speed/webp/?csw=1> <https://chromium.googlesource.com/webm/libwebp/> Additional IP Rights Grant (Patents)"This implementation" means the copyrightable works distributed by Google as part of the WebM Project.Google hereby grants to you a perpetual, worldwide, non-exclusive, no-charge, royalty-free, irrevocable (except as stated in this section)patent license to make, have made, use, offer to sell, sell, import, transfer, and otherwise run, modify and propagate the contents of this implementation of VP8, where such license applies only to those patent

claims, both currently owned by Google and acquired in the future, licensable by Google that are necessarily infringed by this implementation of VP8. This grant does not include claims that would be infringed only as a consequence of further modification of this implementation. If you or your agent or exclusive licensee institute or order or agree to the institution of patent litigation against any entity (including a cross-claim or counterclaim in a lawsuit) alleging that this implementation of VP8 or any code incorporated within this implementation of VP8 constitutes direct or contributory patent infringement, or inducement of patent infringement, then any patent rights granted to you under this License for this implementation of VP8 shall terminate as of the date such litigation is filed.

FaceBook SDK (3.0.1)

This TV contains Facebook SDK. The Facebook SDK for Android is the easiest way to integrate your Android app with Facebook's platform. The SDK provides support for Login with Facebook authentication, reading and writing to Facebook APIs and support for UI elements such as pickers and dialogs. The original download site for this software is : <https://developer.facebook.com/docs/android> This piece of software is made available under the terms and conditions of the Apache License version 2.

iptables (1.4.7)

iptables is a user space application program that allows a system administrator to configure the tables provided by the Linux kernel firewall (implemented as different Netfilter modules) and the chains and rules it stores. Different kernel modules and programs are currently used for different protocols; iptables applies to IPv4. The original download site for this software is : <https://android.google.com> This piece of software is made available under the terms and conditions of the GPL v2.

libyuv (814)

libyuv is an open source project that includes YUV conversion and scaling functionality. The original download site for this software is : <http://code.google.com/p/libyuv> This piece of software is made available under the terms and conditions BSD.

ffmpeg (2.1.3)

This TV uses FFmpeg. FFmpeg is a complete, cross-platform solution to record, convert and stream audio and video. The original download site for this software is : <http://ffmpeg.org> This piece of software is made available under the terms and conditions of the GPL v2 license, which can be found below.

u-boot (2011-12)

U-boot is a boot loader for embedded boards based on ARM, MIPS and other processors, which can be

installed in a boot ROM and used to initialize and test the hardware or to download and run application code

This piece of software is made available under the terms and conditions of the GPL v2 license, which can be found below.

live555 (0.82)

Live555 provides RTP/RTCP/RTSP client. The original download site for this software is : <http://www.live555.com> This piece of software is made available under the terms and conditions of the LGPL v2.1 license, which can be found below.

Bluetooth Stack (Bluedroid)

This TV uses Bluetooth stack. The original download site for this software is : This piece of software is made available under the terms and conditions of Android Apache License Version 2.

EXIF (NA)

Exif JPEG header manipulation tool. The original download site for this software is : <http://www.sentex.net/~mwandel/jhead/> Portions of this source code are in the public domain

Copyright (c) 2008, The Android Open Source Project

All rights reserved. Redistribution and use in source and binary forms, with or without modification, are permitted provided that the following conditions are met: * Redistributions of source code must retain the above copyright notice, this list of conditions and the following disclaimer. * Redistributions in binary form must reproduce the above copyright notice, this list of conditions and the following disclaimer in the documentation and/or other materials provided with the distribution. * Neither the name of The Android Open Source Project nor the names of its contributors may be used to endorse or promote products derived from this software without specific prior written permission. THIS SOFTWARE IS PROVIDED BY THE COPYRIGHT HOLDERS AND CONTRIBUTORS "AS IS" AND ANY EXPRESS OR IMPLIED WARRANTIES, INCLUDING, BUT NOT LIMITED TO, THE IMPLIED WARRANTIES OF MERCHANTABILITY AND FITNESS FOR A PARTICULAR PURPOSE ARE DISCLAIMED. IN NO EVENT SHALL THE COPYRIGHT OWNER OR CONTRIBUTORS BE LIABLE FOR ANY DIRECT, INDIRECT, INCIDENTAL, SPECIAL, EXEMPLARY, OR CONSEQUENTIAL DAMAGES (INCLUDING, BUT NOT LIMITED TO, PROCUREMENT OF SUBSTITUTE GOODS OR SERVICES; LOSS OF USE, DATA, OR PROFITS; OR BUSINESS INTERRUPTION) HOWEVER CAUSED AND ON ANY THEORY OF LIABILITY, WHETHER IN CONTRACT, STRICT LIABILITY, OR TORT (INCLUDING NEGLIGENCE OR OTHERWISE) ARISING IN ANY WAY OUT OF THE USE OF THIS SOFTWARE, EVEN IF ADVISED OF THE POSSIBILITY OF SUCH DAMAGE.

EXPAT (2.1.0)

EXPAT is a XML Parser. The original download site for this software is :

<http://expat.sourceforge.net> Copyright (c) 1998, 1999, 2000 Thai Open Source Software Center Ltd and Clark Cooper

Copyright (c) 2001, 2002, 2003, 2004, 2005, 2006 Expat maintainers. Permission is hereby granted, free of charge, to any person obtaining a copy of this software and associated documentation files (the "Software"), to deal in the Software without restriction, including without limitation the rights to use, copy, modify, merge, publish, distribute, sublicense, and/or sell copies of the Software, and to permit persons to whom the Software is furnished to do so, subject to the following conditions: The above copyright notice and this permission notice shall be included in all copies or substantial portions of the Software. THE SOFTWARE IS PROVIDED "AS IS", WITHOUT WARRANTY OF ANY KIND, EXPRESS OR IMPLIED, INCLUDING BUT NOT LIMITED TO THE WARRANTIES OF MERCHANTABILITY, FITNESS FOR A PARTICULAR PURPOSE AND NONINFRINGEMENT. IN NO EVENT SHALL THE AUTHORS OR COPYRIGHT HOLDERS BE LIABLE FOR ANY CLAIM, DAMAGES OR OTHER LIABILITY, WHETHER IN AN ACTION OF CONTRACT, TORT OR OTHERWISE, ARISING FROM, OUT OF OR IN CONNECTION WITH THE SOFTWARE OR THE USE OR OTHER DEALINGS IN THE SOFTWARE.

neven face recognition library (NA)

This TV uses neven face recognition library which is used for face recognition This piece of software is made available under the terms and conditions of Android Apache License version 2.

Unicode (4.8.1.1)

This TV uses Unicode which specifies the representation of text

The original download site for this software is : <http://icu-project.org> ICU License - ICU 1.8.1 and later

COPYRIGHT AND PERMISSION NOTICE

Copyright (c) 1995-2008 International Business Machines Corporation and others

All rights reserved. Permission is hereby granted, free of charge, to any person obtaining a copy of this software and associated documentation files (the "Software"), to deal in the Software without restriction, including without limitation the rights to use, copy, modify, merge, publish, distribute, and/or sell copies of the Software, and to permit persons to whom the Software is furnished to do so, provided that the above copyright notice(s) and this permission notice appear in all copies of the Software and that both the above copyright notice(s) and this permission notice appear in supporting

documentation. THE SOFTWARE IS PROVIDED "AS IS", WITHOUT WARRANTY OF ANY KIND, EXPRESS OR IMPLIED, INCLUDING BUT NOT LIMITED TO THE WARRANTIES OF MERCHANTABILITY, FITNESS FOR A PARTICULAR PURPOSE AND NONINFRINGEMENT. IN NO EVENT SHALL THE COPYRIGHT HOLDER OR HOLDERS INCLUDED IN THIS NOTICE BE LIABLE FOR ANY CLAIM, OR ANY SPECIAL INDIRECT OR CONSEQUENTIAL DAMAGES, OR ANY DAMAGES WHATSOEVER RESULTING FROM LOSS OF USE, DATA OR PROFITS, WHETHER IN AN ACTION OF CONTRACT, NEGLIGENCE OR OTHER TORTIOUS ACTION, ARISING OUT OF OR IN CONNECTION WITH THE USE OR PERFORMANCE OF THIS SOFTWARE. Except as contained in this notice, the name of a copyright holder shall not be used in advertising or otherwise to promote the sale, use or other dealings in this Software without prior written authorization of the copyright holder. All trademarks and registered trademarks mentioned herein are the property of their respective owners.

IPRoute2 (NA)

IPRoute2 is used for TCP/IP, Networking and Traffic control. The original download site for this software is : <http://www.linuxfoundation.org/collaborate/workgroups/networking/iproute2> This piece of software is made available under the terms and conditions of GPL V2.

mtpd (NA)

mtpd is used for VPN Network. The original download site for this software is : <http://libmtp.sourceforge.net/> This piece of software is made available under the terms and conditions of Apache License version 2.0.

MDNS Responder (NA)

MDNS Responder. The Mdns Responder project is a component of Bonjour, Apple's ease-of-use IP networking initiative. The original download site for this software is : <http://www.opensource.apple.com/tarballs/mDNSResponder/> This piece of software is made available under the terms and conditions of Apache License version 2.0.

NFC (NA)

NFC Semiconductor's NFC Library. Near Field Communication (NFC) is a set of short-range wireless technologies, typically requiring a distance of 4cm or less to initiate a connection. NFC allows you to share small payloads of data between an NFC tag and an Android-powered device, or between two Android-powered devices. This piece of software is made available under the terms and conditions of Apache License version 2.0.

Skia (NA)

Skia is a complete 2D graphic library for drawing Text, Geometries, and Images. The original download site

for this software is :
<http://code.google.com/p/skia/> Copyright (c) 2011 Google Inc. All rights reserved. Redistribution and use in source and binary forms, with or without modification, are permitted provided that the following conditions are met: * Redistributions of source code must retain the above copyright notice, this list of conditions and the following disclaimer. * Redistributions in binary form must reproduce the above copyright notice, this list of conditions and the following disclaimer in the documentation and/or other materials provided with the distribution. * Neither the name of Google Inc. nor the names of its contributors may be used to endorse or promote products derived from this software without specific prior written permission. THIS SOFTWARE IS PROVIDED BY THE COPYRIGHT HOLDERS AND CONTRIBUTORS "AS IS" AND ANY EXPRESS OR IMPLIED WARRANTIES, INCLUDING, BUT NOT LIMITED TO, THE IMPLIED WARRANTIES OF MERCHANTABILITY AND FITNESS FOR A PARTICULAR PURPOSE ARE DISCLAIMED. IN NO EVENT SHALL THE COPYRIGHT OWNER OR CONTRIBUTORS BE LIABLE FOR ANY DIRECT, INDIRECT, INCIDENTAL, SPECIAL, EXEMPLARY, OR CONSEQUENTIAL DAMAGES (INCLUDING, BUT NOT LIMITED TO, PROCUREMENT OF SUBSTITUTE GOODS OR SERVICES; LOSS OF USE, DATA, OR PROFITS; OR BUSINESS INTERRUPTION) HOWEVER CAUSED AND ON ANY THEORY OF LIABILITY, WHETHER IN CONTRACT, STRICT LIABILITY, OR TORT (INCLUDING NEGLIGENCE OR OTHERWISE) ARISING IN ANY WAY OUT OF THE USE OF THIS SOFTWARE, EVEN IF ADVISED OF THE POSSIBILITY OF SUCH DAMAGE.

Sonic Audio Synthesis library (NA)

The original download site for this software is :
<http://www.sonivoxmi.com/> This piece of software is made available under the terms and conditions of Apache License version 2.0.

Sqlite (3071100)

The original download site for this software is :
www.sqlite.org. This piece of software is made available under the terms and conditions of Apache License version 2.0.

Nuance Speech Recognition engine (NA)

The original download site for this software is :
<http://www.nuance.com/> This piece of software is made available under the terms and conditions of Apache License version 2.0.

C++ Standard Template Library library (5)

This TV uses Implementation of the C++ Standard Template Library. The original download site for this software is : <http://stlport.sourceforge.net> Boris Fomitchev grants Licensee a non-exclusive, non-transferable, royalty-free license to use STLport and

its documentation without fee. By downloading, using, or copying STLport or any portion thereof, Licensee agrees to abide by the intellectual property laws and all other applicable laws of the United States of America, and to all of the terms and conditions of this Agreement. Licensee shall maintain the following copyright and permission notices on STLport sources and its documentation unchanged : Copyright 1999,2000 Boris Fomitchev

This material is provided "as is", with absolutely no warranty expressed or implied. Any use is at your own risk. Permission to use or copy this software for any purpose is hereby granted without fee, provided the above notices are retained on all copies. Permission to modify the code and to distribute modified code is granted, provided the above notices are retained, and a notice that the code was modified is included with the above copyright notice. The Licensee may distribute binaries compiled with STLport (whether original or modified) without any royalties or restrictions. The Licensee may distribute original or modified STLport sources, provided that: The conditions indicated in the above permission notice are met; The following copyright notices are retained when present, and conditions provided in accompanying permission notices are met : Copyright 1994 Hewlett-Packard Company Copyright 1996,97 Silicon Graphics Computer Systems, Inc. Copyright 1997 Moscow Center for SPARC Technology. Permission to use, copy, modify, distribute and sell this software and its documentation for any purpose is hereby granted without fee, provided that the above copyright notice appear in all copies and that both that copyright notice and this permission notice appear in supporting documentation. Hewlett-Packard Company makes no representations about the suitability of this software for any purpose. It is provided "as is" without express or implied warranty. Permission to use, copy, modify, distribute and sell this software and its documentation for any purpose is hereby granted without fee, provided that the above copyright notice appear in all copies and that both that copyright notice and this permission notice appear in supporting documentation. Silicon Graphics makes no representations about the suitability of this software for any purpose. It is provided "as is" without express or implied warranty. Permission to use, copy, modify, distribute and sell this software and its documentation for any purpose is hereby granted without fee, provided that the above copyright notice appear in all copies and that both that copyright notice and this permission notice appear in supporting documentation. Moscow Center for SPARC Technology makes no representations about the suitability of this software for any purpose. It is provided "as is" without express or implied warranty svox (NA)

The original download site for this software is :

<http://www.nuance.com/>This piece of software is made available under the terms and conditions of Apache License version 2.0.

tinyalsa (NA)

This TV uses tinyalsa: a small library to interface with ALSA in the Linux kernel The original download site for this software is :

<http://github.com/tinyalsa> Copyright 2011, The Android Open Source Project Redistribution and use in source and binary forms, with or without modification, are permitted provided that the following conditions are met: * Redistributions of source code must retain the above copyright notice, this list of conditions and the following disclaimer. * Redistributions in binary form must reproduce the above copyright notice, this list of conditions and the following disclaimer in the documentation and/or other materials provided with the distribution. * Neither the name of The Android Open Source Project nor the names of its contributors may be used to endorse or promote products derived from this software without specific prior written permission. THIS SOFTWARE IS PROVIDED BY The Android Open Source Project "AS IS" AND ANY EXPRESS OR IMPLIED WARRANTIES, INCLUDING, BUT NOT LIMITED TO, THE IMPLIED WARRANTIES OF MERCHANTABILITY AND FITNESS FOR A PARTICULAR PURPOSE ARE DISCLAIMED. IN NO EVENT SHALL The Android Open Source Project BE LIABLE FOR ANY DIRECT, INDIRECT, INCIDENTAL, SPECIAL, EXEMPLARY, OR CONSEQUENTIAL DAMAGES (INCLUDING, BUT NOT LIMITED TO, PROCUREMENT OF SUBSTITUTE GOODS OR SERVICES; LOSS OF USE, DATA, OR PROFITS; OR BUSINESS INTERRUPTION) HOWEVER CAUSED AND ON ANY THEORY OF LIABILITY, WHETHER IN CONTRACT, STRICT LIABILITY, OR TORT (INCLUDING NEGLIGENCE OR OTHERWISE) ARISING IN ANY WAY OUT OF THE USE OF THIS SOFTWARE, EVEN IF ADVISED OF THE POSSIBILITY OF SUCH DAMAGE.

Vorbis Decompression Library (NA)

This TV uses Tremolo ARM-optimized Ogg Vorbis decompression library. Vorbis is a general purpose audio and music encoding format contemporary to MPEG-4's AAC and TwinVQ, the next generation beyond MPEG audio layer 3 The original download site for this software is :

<http://wss.co.uk/pinknoise/tremo> Copyright (c) 2002-2008 Xiph.org Foundation Redistribution and use in source and binary forms, with or without modification, are permitted provided that the following conditions are met: - Redistributions of source code must retain the above copyright notice, this list of conditions and the following disclaimer. - Redistributions in binary form must reproduce the above copy right notice, this list of conditions and the following disclaimer in the documentation and/or

other materials provided with the distribution. - Neither the name of the Xiph.org Foundation nor the names of its contributors may be used to endorse or promote products derived from this software without specific prior written permission. THIS SOFTWARE IS PROVIDED BY THE COPYRIGHT HOLDERS AND CONTRIBUTORS "AS IS" AND ANY EXPRESS OR IMPLIED WARRANTIES, INCLUDING, BUT NOT LIMITED TO, THE IMPLIED WARRANTIES OF MERCHANTABILITY AND FITNESS FOR A PARTICULAR PURPOSE ARE DISCLAIMED. IN NO EVENT SHALL THE FOUNDATION OR CONTRIBUTORS BE LIABLE FOR ANY DIRECT, INDIRECT, INCIDENTAL, SPECIAL, EXEMPLARY, OR CONSEQUENTIAL DAMAGES (INCLUDING, BUT NOT LIMITED TO, PROCUREMENT OF SUBSTITUTE GOODS OR SERVICES; LOSS OF USE, DATA, OR PROFITS; OR BUSINESS INTERRUPTION) HOWEVER CAUSED AND ON ANY THEORY OF LIABILITY, WHETHER IN CONTRACT, STRICT LIABILITY, OR TORT (INCLUDING NEGLIGENCE OR OTHERWISE) ARISING IN ANY WAY OUT OF THE USE OF THIS SOFTWARE, EVEN IF ADVISED OF THE POSSIBILITY OF SUCH DAMAGE.

wpa_supplicant_Daemon (v0.8)

Library used by legacy HAL to talk to wpa_supplicant daemon The original download site for this software is : http://hostap.epitest.fi/wpa_supplicant/ This piece of software is made available under the terms and conditions of GPL version 2.

gson (2.3)

Gson is a Java library that can be used to convert Java Objects into their JSON representation. It can also be used to convert a JSON string to an equivalent Java object. Gson can work with arbitrary Java objects including pre-existing objects that you do not have source-code of. The original download site for this software is :

<https://code.google.com/p/google-gson/> This piece of software is made available under the terms and conditions of the Apache License 2.0

This software includes an implementation of the AES Cipher, licensed by Brian Gladman

The original download site for this software is : <http://www.gladman.me.uk/> This piece of software is licensed by Brian Gladman

libUpNp (1.2.1)

The original download site for this software is : <http://upnp.sourceforge.net/> This piece of software is made available under the terms and conditions of the BSD.

dnsmasq

Dnsmasq is a lightweight, easy to configure DNS forwarder and DHCP server

The original download site for this software is : <https://>

/android.google.com/platform/external/dnmsq
This piece of software is made available under the terms and conditions of the GPL v2 license, which can be found below.

TomCrypt (1.1)

iwedia stack is using tomcrypt for sw decryption

The original download site for this software is : <http://manpages.ubuntu.com/manpages/saucy/man3/libtomcrypt.3.html>
This piece of software is made available under the terms and conditions of the DO WHAT THE FUCK YOU WANT TO PUBLIC LICENSE

AsyncHttpClient (1.4.6)

The original download site for this software is : <http://loopj.com/android-async-http/>
This piece of software is made available under the terms and conditions of the APACHE LICENSE 2.0

Jackson Parser (2.x)

lpepg client uses Jackson Parser for string manipulation. The original download site for this software is : <https://github.com/FasterXML/jackson-core>
This piece of software is made available under the terms and conditions of the APACHE LICENSE 2.0

TP Vision Netherlands B.V. is grateful to the groups and individuals above for their contributions.

GNU GENERAL PUBLIC LICENSE

Version 2, June 1991

Copyright (C) 1989, 1991 Free Software Foundation, Inc.

51 Franklin Street, Fifth Floor, Boston, MA 02110-1301, USA

Everyone is permitted to copy and distribute verbatim copies

of this license document, but changing it is not allowed.

Preamble

The licenses for most software are designed to take away your freedom to share and change it. By contrast, the GNU General Public License is intended to guarantee your freedom to share and change free software--to make sure the software is free for all its users. This General Public License applies to most of the Free Software Foundation's software and to any other program whose authors commit to using it. (Some other Free Software Foundation software is covered by the GNU Lesser General Public License instead.) You can apply it to your programs, too.

When we speak of free software, we are referring to freedom, not price. Our General Public Licenses are designed to make sure that you have the freedom to distribute copies of free software (and charge for this service if you wish), that you receive source code or can get it if you want it, that you can change the software or use pieces of it in new free programs; and that you know you can do these things.

To protect your rights, we need to make restrictions that forbid anyone to deny you these rights or to ask you to surrender the rights. These restrictions translate to certain responsibilities for you if you distribute copies of the software, or if you modify it.

For example, if you distribute copies of such a program, whether gratis or for a fee, you must give the recipients all the rights that you have. You must make sure that they, too, receive or can get the source code. And you must show them these terms so they know their rights.

We protect your rights with two steps: (1) copyright the software, and (2) offer you this license which gives you legal permission to copy, distribute and/or modify the software.

Also, for each author's protection and ours, we want to make certain that everyone understands that there is no warranty for this free software. If the software is modified by someone else and passed on, we want its recipients to know that what they have is not the original, so that any problems introduced by others will not reflect on the original authors' reputations.

Finally, any free program is threatened constantly by software patents. We wish to avoid the danger that redistributors of a free program will individually obtain patent licenses, in effect making the program proprietary. To prevent this, we have made it clear that any patent must be licensed for everyone's free use or not licensed at all.

The precise terms and conditions for copying, distribution and modification follow.

TERMS AND CONDITIONS FOR COPYING, DISTRIBUTION AND MODIFICATION

Activities other than copying, distribution and modification are not covered by this License; they are outside its scope. The act of running the Program is not restricted, and the output from the Program is covered only if its contents constitute a work based on the Program (independent of having been made by running the Program). Whether that is true depends on what the Program does.

You may charge a fee for the physical act of transferring a copy, and you may at your option offer warranty protection in exchange for a fee.

a) You must cause the modified files to carry prominent notices stating that you changed the files and the date of any change.

b) You must cause any work that you distribute or publish, that in whole or in part contains or is derived from the Program or any part thereof, to be licensed as a whole at no charge to all third parties under the terms of this License.

c) If the modified program normally reads commands interactively when run, you must cause it, when started running for such interactive use in the most ordinary way, to print or display an announcement including an appropriate copyright notice and a notice that there is no warranty (or else, saying that you provide a warranty) and that users may redistribute the program under these conditions, and telling the user how to view a copy of this License. (Exception: if the Program itself is interactive but does not normally print such an announcement, your work based on the Program is not required to print an announcement.)

These requirements apply to the modified work as a whole. If identifiable sections of that work are not derived from the Program, and can be reasonably considered independent and separate works in themselves, then this License, and its terms, do not apply to those sections when you distribute them as separate works. But when you distribute the same sections as part of a whole which is a work based on the Program, the distribution of the whole must be on the terms of this License, whose permissions for other licensees extend to the entire whole, and thus to each and every part regardless of who wrote it.

Thus, it is not the intent of this section to claim rights or contest your rights to work written entirely by you; rather, the intent is to exercise the right to control the distribution of derivative or collective works based on the Program.

In addition, mere aggregation of another work not based on the Program with the Program (or with a work based on the Program) on a volume of a storage or distribution medium does not bring the other work under the scope of this License.

a) Accompany it with the complete corresponding machine-readable source code, which must be distributed under the terms of Sections 1 and 2 above on a medium customarily used for software interchange; or,

b) Accompany it with a written offer, valid for at least three years, to give any third party, for a charge no more than your cost of physically performing source distribution, a complete machine-readable copy of the corresponding source code, to be distributed under the terms of Sections 1 and 2 above on a medium customarily used for software interchange; or,

c) Accompany it with the information you received as to the offer to distribute corresponding source code. (This alternative is allowed only for noncommercial distribution and only if you received the program in

object code or executable form with such an offer, in accord with Subsection b above.)

The source code for a work means the preferred form of the work for making modifications to it. For an executable work, complete source code means all the source code for all modules it contains, plus any associated interface definition files, plus the scripts used to control compilation and installation of the executable. However, as a special exception, the source code distributed need not include anything that is normally distributed (in either source or binary form) with the major components (compiler, kernel, and so on) of the operating system on which the executable runs, unless that component itself accompanies the executable.

If distribution of executable or object code is made by offering access to copy from a designated place, then offering equivalent access to copy the source code from the same place counts as distribution of the source code, even though third parties are not compelled to copy the source along with the object code.

If any portion of this section is held invalid or unenforceable under any particular circumstance, the balance of the section is intended to apply and the section as a whole is intended to apply in other circumstances.

It is not the purpose of this section to induce you to infringe any patents or other property right claims or to contest validity of any such claims; this section has the sole purpose of protecting the integrity of the free software distribution system, which is implemented by public license practices. Many people have made generous contributions to the wide range of software distributed through that system in reliance on consistent application of that system; it is up to the author/donor to decide if he or she is willing to distribute software through any other system and a licensee cannot impose that choice.

This section is intended to make thoroughly clear what is believed to be a consequence of the rest of this License.

Each version is given a distinguishing version number. If the Program specifies a version number of this License which applies to it and "any later version", you have the option of following the terms and conditions either of that version or of any later version published by the Free Software Foundation. If the Program does not specify a version number of this License, you may choose any version ever published by the Free Software Foundation.

NO WARRANTY

GNU LESSER GENERAL PUBLIC LICENSE

Version 2.1, February 1999

Copyright (C) 1991, 1999 Free Software Foundation, Inc.

51 Franklin Street, Fifth Floor, Boston, MA 02110-1301 USA

Everyone is permitted to copy and distribute verbatim copies

of this license document, but changing it is not allowed.

[This is the first released version of the Lesser GPL. It also counts as the successor of the GNU Library Public License, version 2, hence the version number 2.1.]

Preamble

The licenses for most software are designed to take away your freedom to share and change it. By contrast, the GNU General Public Licenses are intended to guarantee your freedom to share and change free software--to make sure the software is free for all its users.

This license, the Lesser General Public License, applies to some specially designated software packages--typically libraries--of the Free Software Foundation and other authors who decide to use it. You can use it too, but we suggest you first think carefully about whether this license or the ordinary General Public License is the better strategy to use in any particular case, based on the explanations below.

When we speak of free software, we are referring to freedom of use, not price. Our General Public Licenses are designed to make sure that you have the freedom to distribute copies of free software (and charge for this service if you wish); that you receive source code or can get it if you want it; that you can change the software and use pieces of it in new free programs; and that you are informed that you can do these things.

To protect your rights, we need to make restrictions that forbid distributors to deny you these rights or to ask you to surrender these rights. These restrictions translate to certain responsibilities for you if you distribute copies of the library or if you modify it.

For example, if you distribute copies of the library, whether gratis or for a fee, you must give the recipients all the rights that we gave you. You must make sure that they, too, receive or can get the source code. If you link other code with the library, you must provide complete object files to the recipients, so that they can relink them with the library after making changes to the library and recompiling it. And you must show them these terms so they know their rights.

We protect your rights with a two-step method: (1) we copyright the library, and (2) we offer you this license, which gives you legal permission to copy, distribute and/or modify the library.

To protect each distributor, we want to make it very clear that there is no warranty for the free library. Also, if the library is modified by someone else and passed on, the recipients should know that what they have is not the original version, so that the original author's reputation will not be affected by problems that might be introduced by others.

Finally, software patents pose a constant threat to the existence of any free program. We wish to make sure that a company cannot effectively restrict the users of a free program by obtaining a restrictive license from a patent holder. Therefore, we insist that any patent license obtained for a version of the library must be consistent with the full freedom of use specified in this license.

Most GNU software, including some libraries, is covered by the ordinary GNU General Public License. This license, the GNU Lesser General Public License, applies to certain designated libraries, and is quite different from the ordinary General Public License. We use this license for certain libraries in order to permit linking those libraries into non-free programs.

When a program is linked with a library, whether statically or using a shared library, the combination of the two is legally speaking a combined work, a derivative of the original library. The ordinary General Public License therefore permits such linking only if the entire combination fits its criteria of freedom. The Lesser General Public License permits more lax criteria for linking other code with the library.

We call this license the "Lesser" General Public License because it does Less to protect the user's freedom than the ordinary General Public License. It also provides other free software developers Less of an advantage over competing non-free programs. These disadvantages are the reason we use the ordinary General Public License for many libraries. However, the Lesser license provides advantages in certain special circumstances.

For example, on rare occasions, there may be a special need to encourage the widest possible use of a certain library, so that it becomes a de-facto standard. To achieve this, non-free programs must be allowed to use the library. A more frequent case is that a free library does the same job as widely used non-free libraries. In this case, there is little to gain by limiting the free library to free software only, so we use the Lesser General Public License.

In other cases, permission to use a particular library in non-free programs enables a greater number of people to use a large body of free software. For example, permission to use the GNU C Library in non-free programs enables many more people to use the

whole GNU operating system, as well as its variant, the GNU/Linux operating system.

Although the Lesser General Public License is less protective of the users' freedom, it does ensure that the user of a program that is linked with the Library has the freedom and the wherewithal to run that program using a modified version of the Library.

The precise terms and conditions for copying, distribution and modification follow. Pay close attention to the difference between a "work based on the library" and a "work that uses the library". The former contains code derived from the library, whereas the latter must be combined with the library in order to run.

TERMS AND CONDITIONS FOR COPYING, DISTRIBUTION AND MODIFICATION

A "library" means a collection of software functions and/or data prepared so as to be conveniently linked with application programs (which use some of those functions and data) to form executables.

The "Library", below, refers to any such software library or work which has been distributed under these terms. A "work based on the Library" means either the Library or any derivative work under copyright law: that is to say, a work containing the Library or a portion of it, either verbatim or with modifications and/or translated straightforwardly into another language. (Hereinafter, translation is included without limitation in the term "modification".)

"Source code" for a work means the preferred form of the work for making modifications to it. For a library, complete source code means all the source code for all modules it contains, plus any associated interface definition files, plus the scripts used to control compilation and installation of the library.

Activities other than copying, distribution and modification are not covered by this License; they are outside its scope. The act of running a program using the Library is not restricted, and output from such a program is covered only if its contents constitute a work based on the Library (independent of the use of the Library in a tool for writing it). Whether that is true depends on what the Library does and what the program that uses the Library does.

You may charge a fee for the physical act of transferring a copy, and you may at your option offer warranty protection in exchange for a fee.

?a) The modified work must itself be a software library.

?b) You must cause the files modified to carry prominent notices stating that you changed the files and the date of any change.

?c) You must cause the whole of the work to be licensed at no charge to all third parties under the terms of this License.

?d) If a facility in the modified Library refers to a function or a table of data to be supplied by an application program that uses the facility, other than as an argument passed when the facility is invoked, then you must make a good faith effort to ensure that, in the event an application does not supply such function or table, the facility still operates, and performs whatever part of its purpose remains meaningful.

(For example, a function in a library to compute square roots has a purpose that is entirely well-defined independent of the application. Therefore, Subsection 2d requires that any application-supplied function or table used by this function must be optional: if the application does not supply it, the square root function must still compute square roots.)

These requirements apply to the modified work as a whole. If identifiable sections of that work are not derived from the Library, and can be reasonably considered independent and separate works in themselves, then this License, and its terms, do not apply to those sections when you distribute them as separate works. But when you distribute the same sections as part of a whole which is a work based on the Library, the distribution of the whole must be on the terms of this License, whose permissions for other licensees extend to the entire whole, and thus to each and every part regardless of who wrote it.

Thus, it is not the intent of this section to claim rights or contest your rights to work written entirely by you; rather, the intent is to exercise the right to control the distribution of derivative or collective works based on the Library.

In addition, mere aggregation of another work not based on the Library with the Library (or with a work based on the Library) on a volume of a storage or distribution medium does not bring the other work under the scope of this License.

Once this change is made in a given copy, it is irreversible for that copy, so the ordinary GNU General Public License applies to all subsequent copies and derivative works made from that copy.

This option is useful when you wish to copy part of the code of the Library into a program that is not a library.

If distribution of object code is made by offering access to copy from a designated place, then offering equivalent access to copy the source code from the same place satisfies the requirement to distribute the source code, even though third parties are not compelled to copy the source along with the object code.

However, linking a "work that uses the Library" with the Library creates an executable that is a derivative of the Library (because it contains portions of the Library), rather than a "work that uses the library". The

executable is therefore covered by this License. Section 6 states terms for distribution of such executables.

When a "work that uses the Library" uses material from a header file that is part of the Library, the object code for the work may be a derivative work of the Library even though the source code is not. Whether this is true is especially significant if the work can be linked without the Library, or if the work is itself a library. The threshold for this to be true is not precisely defined by law.

If such an object file uses only numerical parameters, data structure layouts and accessors, and small macros and small inline functions (ten lines or less in length), then the use of the object file is unrestricted, regardless of whether it is legally a derivative work. (Executables containing this object code plus portions of the Library will still fall under Section 6.)

Otherwise, if the work is a derivative of the Library, you may distribute the object code for the work under the terms of Section 6. Any executables containing that work also fall under Section 6, whether or not they are linked directly with the Library itself.

You must give prominent notice with each copy of the work that the Library is used in it and that the Library and its use are covered by this License. You must supply a copy of this License. If the work during execution displays copyright notices, you must include the copyright notice for the Library among them, as well as a reference directing the user to the copy of this License. Also, you must do one of these things:

?a) Accompany the work with the complete corresponding machine-readable source code for the Library including whatever changes were used in the work (which must be distributed under Sections 1 and 2 above); and, if the work is an executable linked with the Library, with the complete machine-readable "work that uses the Library", as object code and/or source code, so that the user can modify the Library and then relink to produce a modified executable containing the modified Library. (It is understood that the user who changes the contents of definitions files in the Library will not necessarily be able to recompile the application to use the modified definitions.)

?b) Use a suitable shared library mechanism for linking with the Library. A suitable mechanism is one that (1) uses at run time a copy of the library already present on the user's computer system, rather than copying library functions into the executable, and (2) will operate properly with a modified version of the library, if the user installs one, as long as the modified version is interface-compatible with the version that the work was made with.

?c) Accompany the work with a written offer, valid for at least three years, to give the same user the materials specified in Subsection 6a, above, for a

charge no more than the cost of performing this distribution.

?d) If distribution of the work is made by offering access to copy from a designated place, offer equivalent access to copy the above specified materials from the same place.

?e) Verify that the user has already received a copy of these materials or that you have already sent this user a copy.

For an executable, the required form of the "work that uses the Library" must include any data and utility programs needed for reproducing the executable from it. However, as a special exception, the materials to be distributed need not include anything that is normally distributed (in either source or binary form) with the major components (compiler, kernel, and so on) of the operating system on which the executable runs, unless that component itself accompanies the executable.

It may happen that this requirement contradicts the license restrictions of other proprietary libraries that do not normally accompany the operating system. Such a contradiction means you cannot use both them and the Library together in an executable that you distribute.

?a) Accompany the combined library with a copy of the same work based on the Library, uncombined with any other library facilities. This must be distributed under the terms of the Sections above.

?b) Give prominent notice with the combined library of the fact that part of it is a work based on the Library, and explaining where to find the accompanying uncombined form of the same work.

If any portion of this section is held invalid or unenforceable under any particular circumstance, the balance of the section is intended to apply, and the section as a whole is intended to apply in other circumstances.

It is not the purpose of this section to induce you to infringe any patents or other property right claims or to contest validity of any such claims; this section has the sole purpose of protecting the integrity of the free software distribution system which is implemented by public license practices. Many people have made generous contributions to the wide range of software distributed through that system in reliance on consistent application of that system; it is up to the author/donor to decide if he or she is willing to distribute software through any other system and a licensee cannot impose that choice.

This section is intended to make thoroughly clear what is believed to be a consequence of the rest of this License.

Each version is given a distinguishing version number. If the Library specifies a version number of this

License which applies to it and "any later version", you have the option of following the terms and conditions either of that version or of any later version published by the Free Software Foundation. If the Library does not specify a license version number, you may choose any version ever published by the Free Software Foundation.

NO WARRANTY

BSD LICENSE

Redistribution and use in source and binary forms, with or without modification, are permitted provided that the following conditions are met:

THIS SOFTWARE IS PROVIDED BY THE REGENTS AND CONTRIBUTORS "AS IS" AND ANY EXPRESS OR IMPLIED WARRANTIES, INCLUDING, BUT NOT LIMITED TO, THE IMPLIED WARRANTIES OF MERCHANTABILITY AND FITNESS FOR A PARTICULAR PURPOSE ARE DISCLAIMED. IN NO EVENT SHALL THE REGENTS OR CONTRIBUTORS BE LIABLE FOR ANY DIRECT, INDIRECT, INCIDENTAL, SPECIAL, EXEMPLARY, OR CONSEQUENTIAL DAMAGES (INCLUDING, BUT NOT LIMITED TO, PROCUREMENT OF SUBSTITUTE GOODS OR SERVICES; LOSS OF USE, DATA, OR PROFITS; OR BUSINESS INTERRUPTION) HOWEVER CAUSED AND ON ANY THEORY OF LIABILITY, WHETHER IN CONTRACT, STRICT LIABILITY, OR TORT (INCLUDING NEGLIGENCE OR OTHERWISE) ARISING IN ANY WAY OUT OF THE USE OF THIS SOFTWARE, EVEN IF ADVISED OF THE POSSIBILITY OF SUCH DAMAGE.

MIT LICENSE

Permission is hereby granted, free of charge, to any person obtaining

a copy of this software and associated documentation files (the

"Software"), to deal in the Software without restriction, including

without limitation the rights to use, copy, modify, merge, publish,

distribute, sublicense, and/or sell copies of the Software, and to

permit persons to whom the Software is furnished to do so, subject to

the following conditions:

The above copyright notice and this permission notice shall be included

in all copies or substantial portions of the Software.

THE SOFTWARE IS PROVIDED "AS IS", WITHOUT WARRANTY OF ANY KIND,

EXPRESS OR IMPLIED, INCLUDING BUT NOT LIMITED TO THE WARRANTIES OF

MERCHANTABILITY, FITNESS FOR A PARTICULAR PURPOSE AND NONINFRINGEMENT.

IN NO EVENT SHALL THE AUTHORS OR COPYRIGHT HOLDERS BE LIABLE FOR ANY

CLAIM, DAMAGES OR OTHER LIABILITY, WHETHER IN AN ACTION OF CONTRACT,

TORT OR OTHERWISE, ARISING FROM, OUT OF OR IN CONNECTION WITH THE

SOFTWARE OR THE USE OR OTHER DEALINGS IN THE SOFTWARE.

Apache
License

Version 2.0,
January 2004

<http://www.apache.org/licenses/>

TERMS AND CONDITIONS FOR USE, REPRODUCTION, AND DISTRIBUTION

1. Definitions.

"License" shall mean the terms and conditions for use, reproduction,

and distribution as defined by Sections 1 through 9 of this document.

"Licensor" shall mean the copyright owner or entity authorized by

the copyright owner that is granting the License.

"Legal Entity" shall mean the union of the acting entity and all

other entities that control, are controlled by, or are under common

control with that entity. For the purposes of this definition,

"control" means (i) the power, direct or indirect, to cause the

direction or management of such entity, whether by contract or

otherwise, or (ii) ownership of fifty percent (50%) or more of the

outstanding shares, or (iii) beneficial ownership of such entity.

"You" (or "Your") shall mean an individual or Legal Entity

exercising permissions granted by this License.

"Source" form shall mean the preferred form for making modifications,

including but not limited to software source code, documentation

source, and configuration files.

"Object" form shall mean any form resulting from mechanical

transformation or translation of a Source form, including but

not limited to compiled object code, generated documentation,

and conversions to other media types.

"Work" shall mean the work of authorship, whether in Source or

Object form, made available under the License, as indicated by a

copyright notice that is included in or attached to the work

(an example is provided in the Appendix below).

"Derivative Works" shall mean any work, whether in Source or Object

form, that is based on (or derived from) the Work and for which the

editorial revisions, annotations, elaborations, or other modifications

represent, as a whole, an original work of authorship. For the purposes

of this License, Derivative Works shall not include works that remain

separable from, or merely link (or bind by name) to the interfaces of,

the Work and Derivative Works thereof.

"Contribution" shall mean any work of authorship, including

the original version of the Work and any modifications or additions

to that Work or Derivative Works thereof, that is intentionally

submitted to Licensor for inclusion in the Work by the copyright owner

or by an individual or Legal Entity authorized to submit on behalf of

the copyright owner. For the purposes of this definition, "submitted"

means any form of electronic, verbal, or written communication sent

to the Licensor or its representatives, including but not limited to

communication on electronic mailing lists, source code control systems,

and issue tracking systems that are managed by, or on behalf of, the

Licensor for the purpose of discussing and improving the Work, but

excluding communication that is conspicuously marked or otherwise

designated in writing by the copyright owner as "Not a Contribution."

"Contributor" shall mean Licensor and any individual or Legal Entity

on behalf of whom a Contribution has been received by Licensor and

subsequently incorporated within the Work.

2. Grant of Copyright License. Subject to the terms and conditions of

this License, each Contributor hereby grants to You a perpetual,

worldwide, non-exclusive, no-charge, royalty-free, irrevocable

copyright license to reproduce, prepare Derivative Works of,

publicly display, publicly perform, sublicense, and distribute the

Work and such Derivative Works in Source or

Object form.

3. Grant of Patent License. Subject to the terms and conditions of this License, each Contributor hereby grants to You a perpetual, worldwide, non-exclusive, no-charge, royalty-free, irrevocable (except as stated in this section) patent license to make, have made, use, offer to sell, sell, import, and otherwise transfer the Work, where such license applies only to those patent claims licensable by such Contributor that are necessarily infringed by their Contribution(s) alone or by combination of their Contribution(s) with the Work to which such Contribution(s) was submitted. If You institute patent litigation against any entity (including a cross-claim or counterclaim in a lawsuit) alleging that the Work or a Contribution incorporated within the Work constitutes direct or contributory patent infringement, then any patent licenses granted to You under this License for that Work shall terminate as of the date such litigation is filed.

4. Redistribution. You may reproduce and distribute copies of the Work or Derivative Works thereof in any medium, with or without modifications, and in Source or Object form, provided that You meet the following conditions:

(a) You must give any other recipients of the Work or Derivative Works a copy of this License; and

(b) You must cause any modified files to carry prominent notices stating that You changed the files; and

(c) You must retain, in the Source form of any Derivative Works that You distribute, all copyright, patent, trademark, and attribution notices from the Source form of the Work, excluding those notices that do not pertain to any part of the Derivative Works; and

(d) If the Work includes a "NOTICE" text file as part of its distribution, then any Derivative Works that You distribute must include a readable copy of the attribution notices contained within such NOTICE file, excluding those notices that do not pertain to any part of the Derivative Works, in at least one of the following places: within a NOTICE text file distributed as part of the Derivative Works; within the Source form or documentation, if provided along with the Derivative Works; or, within a display generated by the Derivative Works, if and wherever such third-party notices normally appear. The contents of the NOTICE file are for informational purposes only and do not modify the License. You may add Your own attribution notices within Derivative Works that You distribute, alongside or as an addendum to the NOTICE text from the Work, provided that such additional attribution notices cannot be construed as modifying the License.

You may add Your own copyright statement to Your modifications and may provide additional or different license terms and conditions for use, reproduction, or distribution of Your

modifications, or

for any such Derivative Works as a whole, provided Your use,

reproduction, and distribution of the Work otherwise complies with

the conditions stated in this License.

5. Submission of Contributions. Unless You explicitly state otherwise,

any Contribution intentionally submitted for inclusion in the Work

by You to the Licensor shall be under the terms and conditions of

this License, without any additional terms or conditions.

Notwithstanding the above, nothing herein shall supersede or modify

the terms of any separate license agreement you may have executed

with Licensor regarding such Contributions.

6. Trademarks. This License does not grant permission to use the trade

names, trademarks, service marks, or product names of the Licensor,

except as required for reasonable and customary use in describing the

origin of the Work and reproducing the content of the NOTICE file.

7. Disclaimer of Warranty. Unless required by applicable law or

agreed to in writing, Licensor provides the Work (and each

Contributor provides its Contributions) on an "AS IS" BASIS,

WITHOUT WARRANTIES OR CONDITIONS OF ANY KIND, either express or

implied, including, without limitation, any warranties or conditions

of TITLE, NON-INFRINGEMENT, MERCHANTABILITY, or FITNESS FOR A

PARTICULAR PURPOSE. You are solely responsible for determining the

appropriateness of using or redistributing the Work and assume any

risks associated with Your exercise of permissions under this License.

8. Limitation of Liability. In no event and under no legal theory,

whether in tort (including negligence), contract, or otherwise,

unless required by applicable law (such as deliberate and grossly

negligent acts) or agreed to in writing, shall any Contributor be

liable to You for damages, including any direct, indirect, special,

incidental, or consequential damages of any character arising as a

result of this License or out of the use or inability to use the

Work (including but not limited to damages for loss of goodwill,

work stoppage, computer failure or malfunction, or any and all

other commercial damages or losses), even if such Contributor

has been advised of the possibility of such damages.

9. Accepting Warranty or Additional Liability. While redistributing

the Work or Derivative Works thereof, You may choose to offer,

and charge a fee for, acceptance of support, warranty, indemnity,

or other liability obligations and/or rights consistent with this

License. However, in accepting such obligations, You may act only

on Your own behalf and on Your sole responsibility, not on behalf

of any other Contributor, and only if You agree to indemnify,

defend, and hold each Contributor harmless for any liability

incurred by, or claims asserted against, such Contributor by reason

of your accepting any such warranty or additional liability.

END OF TERMS AND CONDITIONS

APPENDIX: How to apply the Apache License to

your work.

To apply the Apache License to your work, attach the following

boilerplate notice, with the fields enclosed by brackets "[]"

replaced with your own identifying information. (Don't include

the brackets!) The text should be enclosed in the appropriate

comment syntax for the file format. We also recommend that a

file or class name and description of purpose be included on the

same "printed page" as the copyright notice for easier

identification within third-party archives.

Copyright [yyyy] [name of copyright owner]

Licensed under the Apache License, Version 2.0 (the "License");

you may not use this file except in compliance with the License.

You may obtain a copy of the License at

<http://www.apache.org/licenses/LICENSE-2.0>

Unless required by applicable law or agreed to in writing, software

distributed under the License is distributed on an "AS IS" BASIS,

WITHOUT WARRANTIES OR CONDITIONS OF ANY KIND, either express or implied.

See the License for the specific language governing permissions and

limitations under the License.

This copy of the libpng notices is provided for your convenience. In case of any discrepancy between this copy and the notices in

the file png.h that is

included in the libpng distribution, the latter shall prevail.

COPYRIGHT NOTICE, DISCLAIMER, and LICENSE:

If you modify libpng you may insert additional notices immediately following

this sentence.

This code is released under the libpng license.

libpng versions 1.2.6, August 15, 2004, through 1.4.1, February 25, 2010, are

Copyright (c) 2004, 2006-2007 Glenn Randers-Pehrson, and are

distributed according to the same disclaimer and license as libpng-1.2.5

with the following individual added to the list of Contributing Authors

Cosmin Truta

libpng versions 1.0.7, July 1, 2000, through 1.2.5 - October 3, 2002, are

Copyright (c) 2000-2002 Glenn Randers-Pehrson, and are

distributed according to the same disclaimer and license as libpng-1.0.6

with the following individuals added to the list of Contributing Authors

Simon-Pierre Cadieux

Eric S. Raymond

Gilles Vollant

and with the following additions to the disclaimer:

There is no warranty against interference with your enjoyment of the

library or against infringement. There is no warranty that our

efforts or the library will fulfill any of your particular purposes

or needs. This library is provided with all faults, and the entire

risk of satisfactory quality, performance, accuracy, and effort is with

the user.

libpng versions 0.97, January 1998, through 1.0.6, March 20, 2000, are

Copyright (c) 1998, 1999 Glenn Randers-Pehrson, and are

distributed according to the same disclaimer and license as libpng-0.96,

with the following individuals added to the list of Contributing Authors:

Tom Lane

Glenn Randers-Pehrson

Willem van Schaik

libpng versions 0.89, June 1996, through 0.96, May 1997, are

Copyright (c) 1996, 1997 Andreas Dilger

Distributed according to the same disclaimer and license as libpng-0.88,

with the following individuals added to the list of Contributing Authors:

John Bowler

Kevin Bracey

Sam Bushell

Magnus Holmgren

Greg Roelofs

Tom Tanner

libpng versions 0.5, May 1995, through 0.88, January 1996, are

Copyright (c) 1995, 1996 Guy Eric Schalnat, Group 42, Inc.

For the purposes of this copyright and license, "Contributing Authors"

is defined as the following set of individuals:

Andreas Dilger

Dave Martindale

Guy Eric Schalnat

Paul Schmidt

Tim Wegner

The PNG Reference Library is supplied "AS IS". The Contributing Authors

and Group 42, Inc. disclaim all warranties, expressed or implied,

including, without limitation, the warranties of merchantability and of

fitness for any purpose. The Contributing Authors and Group 42, Inc.

assume no liability for direct, indirect, incidental, special, exemplary,

or consequential damages, which may result from the use of the PNG

Reference Library, even if advised of the possibility of such damage.

Permission is hereby granted to use, copy, modify, and distribute this

source code, or portions hereof, for any purpose, without fee, subject

to the following restrictions:

be misrepresented as being the original source.

source or altered source distribution.

The Contributing Authors and Group 42, Inc. specifically permit, without

fee, and encourage the use of this source code as a component to

supporting the PNG file format in commercial products. If you use this

source code in a product, acknowledgment is not required but would be

A "png_get_copyright" function is available, for convenient use in "about"

boxes and the like:

```
printf("%s",png_get_copyright(NULL));
```

Also, the PNG logo (in PNG format, of course) is supplied in the

files "pngbar.png.jpg" and "pngbar.jpg (88x31) and "pngnow.png.jpg" (98x31).

Libpng is OSI Certified Open Source Software. OSI Certified Open Source is a certification mark of the Open Source Initiative.

Glenn Randers-Pehrson
glennrp at users.sourceforge.net
February 25, 2010

This software is based in part on the work of the FreeType Team.

The FreeType Project
LICENSE

2006-Jan-27

Copyright 1996-2002,
2006 by
David Turner, Robert Wilhelm, and
Werner Lemberg

Introduction
=====

The FreeType Project is distributed in several archive packages;
some of them may contain, in addition to the FreeType font engine,
various tools and contributions which rely on, or relate to, the
FreeType Project.

This license applies to all files found in such packages, and

which do not fall under their own explicit license. The license

affects thus the FreeType font engine, the test programs,

documentation and makefiles, at the very least.

This license was inspired by the BSD, Artistic, and IJG

(Independent JPEG Group) licenses, which all encourage inclusion

and use of free software in commercial and freeware products

alike. As a consequence, its main points are that:

- o We don't promise that this software works. However, we will be

- interested in any kind of bug reports. ('as is' distribution)

- o You can use this software for whatever you want, in parts or

- full form, without having to pay us. ('royalty-free' usage)

- o You may not pretend that you wrote this software. If you use

- it, or only parts of it, in a program, you must acknowledge

- somewhere in your documentation that you have used the

- FreeType code. ('credits')

We specifically permit and encourage the inclusion of this

software, with or without modifications, in commercial products.

We disclaim all warranties covering The FreeType Project and

assume no liability related to The FreeType Project.

Finally, many people asked us for a preferred form for a

credit/disclaimer to use in compliance with this license. We thus

encourage you to use the following text:

""

Portions of this software are copyright ?<year>
The FreeType
Project (www.freetype.org). All rights reserved.

""

Please replace <year> with the value from the
FreeType version you
actually use.

Legal Terms

=====

Throughout this license, the terms 'package',
'FreeType Project',
and 'FreeType archive' refer to the set of
files originally
distributed by the authors (David Turner,
Robert Wilhelm, and
Werner Lemberg) as the 'FreeType Project', be they
named as alpha,
beta or final release.

'You' refers to the licensee, or person using the
project, where
'using' is a generic term including compiling the
project's source
code as well as linking it to form a 'program' or
'executable'.
This program is referred to as 'a program
using the FreeType
engine'.

This license applies to all files distributed in
the original
FreeType Project, including all source
code, binaries and
documentation, unless otherwise stated in
the file in its
original, unmodified form as distributed in the
original archive.

If you are unsure whether or not a particular file
is covered by

this license, you must contact us to verify this.

The FreeType Project is copyright (C) 1996-2000
by David Turner,

Robert Wilhelm, and Werner Lemberg. All rights
reserved except as

specified below.

THE FREETYPE PROJECT IS PROVIDED 'AS IS'
WITHOUT WARRANTY OF ANY

KIND, EITHER EXPRESS OR IMPLIED,
INCLUDING, BUT NOT LIMITED TO,

WARRANTIES OF MERCHANTABILITY AND
FITNESS FOR A PARTICULAR

PURPOSE. IN NO EVENT WILL ANY OF THE
AUTHORS OR COPYRIGHT HOLDERS

BE LIABLE FOR ANY DAMAGES CAUSED BY THE
USE OR THE INABILITY TO

USE, OF THE FREETYPE PROJECT.

This license grants a worldwide, royalty-free,
perpetual and

irrevocable right and license to use, execute,
perform, compile,

display, copy, create derivative works of,
distribute and

sublicense the FreeType Project (in both source
and object code

forms) and derivative works thereof for any
purpose; and to

authorize others to exercise some or all of the
rights granted

herein, subject to the following conditions:

o Redistribution of source code must retain
this license file

('FTL.TXT') unaltered; any additions,
deletions or changes to

the original files must be clearly indicated in
accompanying

documentation. The copyright notices
of the unaltered,

original files must be preserved in all

copies of source files.

o Redistribution in binary form must provide a disclaimer that

states that the software is based in part of the work of the

FreeType Team, in the distribution documentation. We also

encourage you to put an URL to the FreeType web page in your

documentation, though this isn't mandatory.

These conditions apply to any software derived from or based on

the FreeType Project, not just the unmodified files. If you use

our work, you must acknowledge us. However, no fee need be paid

to us.

Neither the FreeType authors and contributors nor you shall use

the name of the other for commercial, advertising, or promotional

purposes without specific prior written permission.

We suggest, but do not require, that you use one or more of the

following phrases to refer to this software in your documentation

or advertising materials: 'FreeType Project', 'FreeType Engine',

'FreeType library', or 'FreeType Distribution'.

As you have not signed this license, you are not required to

accept it. However, as the FreeType Project is copyrighted

material, only this license, or another one contracted with the

authors, grants you the right to use, distribute, and modify it.

Therefore, by using, distributing, or modifying the FreeType

Project, you indicate that you understand and accept all the terms

of this license.

There are two mailing lists related to FreeType:

o freetype@nongnu.org

Discusses general use and applications of FreeType, as well as

future and wanted additions to the library and distribution.

If you are looking for support, start in this list if you

haven't found anything to help you in the documentation.

o freetype-devel@nongnu.org

Discusses bugs, as well as engine internals, design issues,

specific licenses, porting, etc.

Our home page can be found at

<http://www.freetype.org>

--- end of FTL.TXT ---

LICENSE ISSUES

=====

The OpenSSL toolkit stays under a dual license, i.e. both the conditions of

the OpenSSL License and the original SSLeay license apply to the toolkit.

See below for the actual license texts. Actually both licenses are BSD-style

Open Source licenses. In case of any license issues related to OpenSSL

please contact openssl-core@openssl.org.

OpenSSL License

/*

=====

* Copyright (c) 1998-2011 The OpenSSL Project. All rights reserved.

*

* Redistribution and use in source and binary forms, with or without

* modification, are permitted provided that the following conditions

* are met:

*

* 1. Redistributions of source code must retain the above copyright

* notice, this list of conditions and the following disclaimer.

*

* 2. Redistributions in binary form must reproduce the above copyright

* notice, this list of conditions and the following disclaimer in

* the documentation and/or other materials provided with the

* distribution.

*

* 3. All advertising materials mentioning features or use of this

* software must display the following acknowledgment:

* "This product includes software developed by the OpenSSL Project

* for use in the OpenSSL Toolkit.
(<http://www.openssl.org/>)"

*

* 4. The names "OpenSSL Toolkit" and "OpenSSL Project" must not be used to

* endorse or promote products derived from this software without

* prior written permission. For written permission, please contact

* openssl-core@openssl.org.

*

* 5. Products derived from this software may not be called "OpenSSL"

* nor may "OpenSSL" appear in their names without prior written

* permission of the OpenSSL Project.

*

* 6. Redistributions of any form whatsoever must retain the following

* acknowledgment:

* "This product includes software developed by the OpenSSL Project

* for use in the OpenSSL Toolkit
(<http://www.openssl.org/>)"

*

* THIS SOFTWARE IS PROVIDED BY THE OpenSSL PROJECT "AS IS" AND ANY

* EXPRESSED OR IMPLIED WARRANTIES, INCLUDING, BUT NOT LIMITED TO, THE

* IMPLIED WARRANTIES OF MERCHANTABILITY AND FITNESS FOR A PARTICULAR

* PURPOSE ARE DISCLAIMED. IN NO EVENT SHALL THE OpenSSL PROJECT OR

* ITS CONTRIBUTORS BE LIABLE FOR ANY DIRECT, INDIRECT, INCIDENTAL,

* SPECIAL, EXEMPLARY, OR CONSEQUENTIAL DAMAGES (INCLUDING, BUT

* NOT LIMITED TO, PROCUREMENT OF SUBSTITUTE GOODS OR SERVICES;

* LOSS OF USE, DATA, OR PROFITS; OR BUSINESS INTERRUPTION)

* HOWEVER CAUSED AND ON ANY THEORY OF LIABILITY, WHETHER IN CONTRACT,

* STRICT LIABILITY, OR TORT (INCLUDING NEGLIGENCE OR OTHERWISE)

* ARISING IN ANY WAY OUT OF THE USE OF THIS SOFTWARE, EVEN IF ADVISED

* OF THE POSSIBILITY OF SUCH DAMAGE.

*

=====

*

* This product includes cryptographic software written by Eric Young

* (eay@cryptsoft.com). This product includes software written by Tim

* Hudson (tjh@cryptsoft.com).

```

*
*/

Original SSLeay License
-----

/* Copyright (C) 1995-1998 Eric Young
(eay@cryptsoft.com)
* All rights reserved.
*
* This package is an SSL implementation written
* by Eric Young (eay@cryptsoft.com).
* The implementation was written so as to conform
with Netscapes SSL.
*
* This library is free for commercial and non-
commercial use as long as
* the following conditions are aheared to. The
following conditions
* apply to all code found in this distribution, be it the
RC4, RSA,
* lhash, DES, etc., code; not just the SSL code. The
SSL documentation
* included with this distribution is covered by the
same copyright terms
* except that the holder is Tim Hudson
(tjh@cryptsoft.com).
*
* Copyright remains Eric Young's, and as such any
Copyright notices in
* the code are not to be removed.
* If this package is used in a product, Eric Young
should be given attribution
* as the author of the parts of the library used.
* This can be in the form of a textual message at
program startup or
* in documentation (online or textual) provided with
the package.
*
* Redistribution and use in source and binary forms,
with or without
* modification, are permitted provided that the
following conditions
* are met:
* 1. Redistributions of source code must retain the
copyright

```

```

* notice, this list of conditions and the following
disclaimer.
* 2. Redistributions in binary form must reproduce
the above copyright
* notice, this list of conditions and the following
disclaimer in the
* documentation and/or other materials
provided with the distribution.
* 3. All advertising materials mentioning features or
use of this software
* must display the following acknowledgement:
* "This product includes cryptographic software
written by
* Eric Young (eay@cryptsoft.com)"
* The word 'cryptographic' can be left out if the
rouines from the library
* being used are not cryptographic related :-).
* 4. If you include any Windows specific code (or a
derivative thereof) from
* the apps directory (application code) you must
include an acknowledgement:
* "This product includes software written by Tim
Hudson (tjh@cryptsoft.com)"
*
* THIS SOFTWARE IS PROVIDED BY ERIC YOUNG
"AS IS" AND
* ANY EXPRESS OR IMPLIED WARRANTIES,
INCLUDING, BUT NOT LIMITED TO, THE
* IMPLIED WARRANTIES OF MERCHANTABILITY
AND FITNESS FOR A PARTICULAR PURPOSE
* ARE DISCLAIMED. IN NO EVENT SHALL THE
AUTHOR OR CONTRIBUTORS BE LIABLE
* FOR ANY DIRECT, INDIRECT, INCIDENTAL,
SPECIAL, EXEMPLARY, OR CONSEQUENTIAL
* DAMAGES (INCLUDING, BUT NOT LIMITED TO,
PROCUREMENT OF SUBSTITUTE GOODS
* OR SERVICES; LOSS OF USE, DATA, OR PROFITS;
OR BUSINESS INTERRUPTION)
* HOWEVER CAUSED AND ON ANY THEORY OF
LIABILITY, WHETHER IN CONTRACT, STRICT
* LIABILITY, OR TORT (INCLUDING NEGLIGENCE OR
OTHERWISE) ARISING IN ANY WAY
* OUT OF THE USE OF THIS SOFTWARE, EVEN IF
ADVISED OF THE POSSIBILITY OF
* SUCH DAMAGE.
*
* The licence and distribution terms for any
publically available version or

```

* derivative of this code cannot be changed. i.e. this code cannot simply be

* copied and put under another distribution licence

* [including the GNU Public Licence.]

*/

MOZILLA PUBLIC
LICENSE
Version 1.1

1.0.1. "Commercial Use" means distribution or otherwise making the

Covered Code available to a third party.

1.1. "Contributor" means each entity that creates or contributes to

the creation of Modifications.

1.2. "Contributor Version" means the combination of the Original

Code, prior Modifications used by a Contributor, and the Modifications

made by that particular Contributor.

1.3. "Covered Code" means the Original Code or Modifications or the

combination of the Original Code and Modifications, in each case

including portions thereof.

1.4. "Electronic Distribution Mechanism" means a mechanism generally

accepted in the software development community for the electronic

transfer of data.

1.5. "Executable" means Covered Code in any form other than Source

Code.

1.6. "Initial Developer" means the individual or entity identified

as the Initial Developer in the Source Code notice required by Exhibit

A.

1.7. "Larger Work" means a work which combines Covered Code or

portions thereof with code not governed by the terms of this License.

1.8. "License" means this document.

1.8.1. "Licensable" means having the right to grant, to the maximum

extent possible, whether at the time of the initial grant or

subsequently acquired, any and all of the rights conveyed herein.

1.9. "Modifications" means any addition to or deletion from the

substance or structure of either the Original Code or any previous

Modifications. When Covered Code is released as a series of files, a

Modification is:

A. Any addition to or deletion from the contents of a file

containing Original Code or previous Modifications.

B. Any new file that contains any part of the Original Code or

previous Modifications.

1.10. "Original Code" means Source Code of computer software code

which is described in the Source Code notice required by Exhibit A as

Original Code, and which, at the time of its release under this

License is not already Covered Code governed by this License.

1.10.1. "Patent Claims" means any patent claim(s), now owned or hereafter acquired, including without limitation, method, process, and apparatus claims, in any patent Licensable by grantor.

1.11. "Source Code" means the preferred form of the Covered Code for making modifications to it, including all modules it contains, plus any associated interface definition files, scripts used to control compilation and installation of an Executable, or source code differential comparisons against either the Original Code or another well known, available Covered Code of the Contributor's choice. The Source Code can be in a compressed or archival form, provided the appropriate decompression or de-archiving software is widely available for no charge.

1.12. "You" (or "Your") means an individual or a legal entity exercising rights under, and complying with all of the terms of, this License or a future version of this License issued under Section 6.1. For legal entities, "You" includes any entity which controls, is controlled by, or is under common control with You. For purposes of this definition, "control" means (a) the power, direct or indirect, to cause the direction or management of such entity, whether by contract or otherwise, or (b) ownership of more than fifty percent (50%) of the outstanding shares or beneficial ownership of such entity.

2.1. The Initial Developer Grant.

The Initial Developer hereby grants You a world-

wide, royalty-free,

non-exclusive license, subject to third party intellectual property

claims:

(a) under intellectual property rights (other than patent or

trademark) Licensable by Initial Developer to use, reproduce,

modify, display, perform, sublicense and distribute the Original

Code (or portions thereof) with or without Modifications, and/or

as part of a Larger Work; and

(b) under Patents Claims infringed by the making, using or

selling of Original Code, to make, have made, use, practice,

sell, and offer for sale, and/or otherwise dispose of the

Original Code (or portions thereof).

(c) the licenses granted in this Section 2.1(a) and (b) are

effective on the date Initial Developer first distributes

Original Code under the terms of this License.

(d) Notwithstanding Section 2.1(b) above, no patent license is

granted: 1) for code that You delete from the Original Code; 2)

separate from the Original Code; or 3) for infringements caused

by: i) the modification of the Original Code or ii) the

combination of the Original Code with other software or devices.

2.2. Contributor Grant.

Subject to third party intellectual property claims, each Contributor

hereby grants You a world-wide, royalty-free, non-exclusive license

(a) under intellectual property rights

(other than patent or trademark) Licensable by Contributor, to use, reproduce, modify, display, perform, sublicense and distribute the Modifications created by such Contributor (or portions thereof) either on an unmodified basis, with other Modifications, as Covered Code and/or as part of a Larger Work; and

(b) under Patent Claims infringed by the making, using, or selling of Modifications made by that Contributor either alone and/or in combination with its Contributor Version (or portions of such combination), to make, use, sell, offer for sale, have made, and/or otherwise dispose of: 1) Modifications made by that Contributor (or portions thereof); and 2) the combination of Modifications made by that Contributor with its Contributor Version (or portions of such combination).

(c) the licenses granted in Sections 2.2(a) and 2.2(b) are effective on the date Contributor first makes Commercial Use of the Covered Code.

(d) Notwithstanding Section 2.2(b) above, no patent license is granted: 1) for any code that Contributor has deleted from the Contributor Version; 2) separate from the Contributor Version; 3) for infringements caused by: i) third party modifications of Contributor Version or ii) the combination of Modifications made by that Contributor with other software (except as part of the Contributor Version) or other devices; or 4) under Patent Claims

infringed by Covered Code in the absence of Modifications made by that Contributor.

3.1. Application of License.

The Modifications which You create or to which You contribute are

governed by the terms of this License, including without limitation

Section 2.2. The Source Code version of Covered Code may be

distributed only under the terms of this License or a future version

of this License released under Section 6.1, and You must include a

copy of this License with every copy of the Source Code You

distribute. You may not offer or impose any terms on any Source Code

version that alters or restricts the applicable version of this

License or the recipients' rights hereunder. However, You may include

an additional document offering the additional rights described in

Section 3.5.

3.2. Availability of Source Code.

Any Modification which You create or to which You contribute must be

made available in Source Code form under the terms of this License

either on the same media as an Executable version or via an accepted

Electronic Distribution Mechanism to anyone to whom you made an

Executable version available; and if made available via Electronic

Distribution Mechanism, must remain available for at least twelve (12)

months after the date it initially became available, or at least six

(6) months after a subsequent version of that particular Modification

has been made available to such recipients. You are responsible for

ensuring that the Source Code version remains

available even if the

Electronic Distribution Mechanism is maintained by a third party.

3.3. Description of Modifications.

You must cause all Covered Code to which You contribute to contain a

file documenting the changes You made to create that Covered Code and

the date of any change. You must include a prominent statement that

the Modification is derived, directly or indirectly, from Original

Code provided by the Initial Developer and including the name of the

Initial Developer in (a) the Source Code, and (b) in any notice in an

Executable version or related documentation in which You describe the

origin or ownership of the Covered Code.

3.4. Intellectual Property Matters

(a) Third Party Claims.

If Contributor has knowledge that a license under a third party's

intellectual property rights is required to exercise the rights

granted by such Contributor under Sections 2.1 or 2.2,

Contributor must include a text file with the Source Code

distribution titled "LEGAL" which describes the claim and the

party making the claim in sufficient detail that a recipient will

know whom to contact. If Contributor obtains such knowledge after

the Modification is made available as described in Section 3.2,

Contributor shall promptly modify the LEGAL file in all copies

Contributor makes available thereafter and shall take other steps

(such as notifying appropriate mailing lists or newsgroups)

reasonably calculated to inform those who received the Covered

Code that new knowledge has been

obtained.

(b) Contributor APIs.

If Contributor's Modifications include an application programming

interface and Contributor has knowledge of patent licenses which

are reasonably necessary to implement that API, Contributor must

also include this information in the LEGAL file.

(c) Representations.

Contributor represents that, except as disclosed pursuant to

Section 3.4(a) above, Contributor believes that Contributor's

Modifications are Contributor's original creation(s) and/or

Contributor has sufficient rights to grant the rights conveyed by

this License.

3.5. Required Notices.

You must duplicate the notice in Exhibit A in each file of the Source

Code. If it is not possible to put such notice in a particular Source

Code file due to its structure, then You must include such notice in a

location (such as a relevant directory) where a user would be likely

to look for such a notice. If You created one or more Modification(s)

You may add your name as a Contributor to the notice described in

Exhibit A. You must also duplicate this License in any documentation

for the Source Code where You describe recipients' rights or ownership

rights relating to Covered Code. You may choose to offer, and to

charge a fee for, warranty, support, indemnity or liability

obligations to one or more recipients of Covered Code. However, You

may do so only on Your own behalf, and not on behalf of the Initial

Developer or any Contributor. You must make it absolutely clear than

any such warranty, support, indemnity or liability obligation is

offered by You alone, and You hereby agree to indemnify the Initial

Developer and every Contributor for any liability incurred by the

Initial Developer or such Contributor as a result of warranty,

support, indemnity or liability terms You offer.

3.6. Distribution of Executable Versions.

You may distribute Covered Code in Executable form only if the

requirements of Section 3.1-3.5 have been met for that Covered Code,

and if You include a notice stating that the Source Code version of

the Covered Code is available under the terms of this License,

including a description of how and where You have fulfilled the

obligations of Section 3.2. The notice must be conspicuously included

in any notice in an Executable version, related documentation or

collateral in which You describe recipients' rights relating to the

Covered Code. You may distribute the Executable version of Covered

Code or ownership rights under a license of Your choice, which may

contain terms different from this License, provided that You are in

compliance with the terms of this License and that the license for the

Executable version does not attempt to limit or alter the recipient's

rights in the Source Code version from the rights set forth in this

License. If You distribute the Executable version under a different

license You must make it absolutely clear that any terms which differ

from this License are offered by You alone, not by the Initial

Developer or any Contributor. You hereby agree

to indemnify the

Initial Developer and every Contributor for any liability incurred by

the Initial Developer or such Contributor as a result of any such

terms You offer.

3.7. Larger Works.

You may create a Larger Work by combining Covered Code with other code

not governed by the terms of this License and distribute the Larger

Work as a single product. In such a case, You must make sure the

requirements of this License are fulfilled for the Covered Code.

If it is impossible for You to comply with any of the terms of this

License with respect to some or all of the Covered Code due to

statute, judicial order, or regulation then You must: (a) comply with

the terms of this License to the maximum extent possible; and (b)

describe the limitations and the code they affect. Such description

must be included in the LEGAL file described in Section 3.4 and must

be included with all distributions of the Source Code. Except to the

extent prohibited by statute or regulation, such description must be

sufficiently detailed for a recipient of ordinary skill to be able to

understand it.

This License applies to code to which the Initial Developer has

attached the notice in Exhibit A and to related Covered Code.

6.1. New Versions.

Netscape Communications Corporation

("Netscape") may publish revised and/or new versions of the License from time to time. Each version will be given a distinguishing version number.

6.2. Effect of New Versions.

Once Covered Code has been published under a particular version of the License, You may always continue to use it under the terms of that version. You may also choose to use such Covered Code under the terms of any subsequent version of the License published by Netscape. No one other than Netscape has the right to modify the terms applicable to Covered Code created under this License.

6.3. Derivative Works.

If You create or use a modified version of this License (which you may only do in order to apply it to code which is not already Covered Code governed by this License), You must (a) rename Your license so that the phrases "Mozilla", "MOZILLAPL", "MOZPL", "Netscape", "MPL", "NPL" or any confusingly similar phrase do not appear in your license (except to note that your license differs from this License) and (b) otherwise make it clear that Your version of the license contains terms which differ from the Mozilla Public License and Netscape Public License. (Filling in the name of the Initial Developer, Original Code or Contributor in the notice described in Exhibit A shall not of themselves be deemed to be modifications of this License.)

COVERED CODE IS PROVIDED UNDER THIS LICENSE ON AN "AS IS" BASIS, WITHOUT WARRANTY OF ANY KIND, EITHER

EXPRESSED OR IMPLIED, INCLUDING,

WITHOUT LIMITATION, WARRANTIES THAT THE COVERED CODE IS FREE OF

DEFECTS, MERCHANTABILITY, FIT FOR A PARTICULAR PURPOSE OR NON-INFRINGEMENT.

THE ENTIRE RISK AS TO THE QUALITY AND PERFORMANCE OF THE COVERED CODE

IS WITH YOU. SHOULD ANY COVERED CODE PROVE DEFECTIVE IN ANY RESPECT,

YOU (NOT THE INITIAL DEVELOPER OR ANY OTHER CONTRIBUTOR) ASSUME THE

COST OF ANY NECESSARY SERVICING, REPAIR OR CORRECTION. THIS DISCLAIMER

OF WARRANTY CONSTITUTES AN ESSENTIAL PART OF THIS LICENSE. NO USE OF

ANY COVERED CODE IS AUTHORIZED HEREUNDER EXCEPT UNDER THIS DISCLAIMER.

8.1. This License and the rights granted hereunder will terminate

automatically if You fail to comply with terms herein and fail to cure

such breach within 30 days of becoming aware of the breach. All

sublicenses to the Covered Code which are properly granted shall

survive any termination of this License. Provisions which, by their

nature, must remain in effect beyond the termination of this License

shall survive.

8.2. If You initiate litigation by asserting a patent infringement

claim (excluding declaratory judgment actions) against Initial Developer

or a Contributor (the Initial Developer or Contributor against whom

You file such action is referred to as "Participant") alleging that:

(a) such Participant's Contributor Version directly or indirectly

infringes any patent, then any and all rights granted by such

Participant to You under Sections 2.1 and/or 2.2 of this License

shall, upon 60 days notice from Participant terminate prospectively,

unless if within 60 days after receipt of notice You either: (i)

agree in writing to pay Participant a mutually agreeable reasonable

royalty for Your past and future use of Modifications made by such

Participant, or (ii) withdraw Your litigation claim with respect to

the Contributor Version against such Participant. If within 60 days

of notice, a reasonable royalty and payment arrangement are not

mutually agreed upon in writing by the parties or the litigation claim

is not withdrawn, the rights granted by Participant to You under

Sections 2.1 and/or 2.2 automatically terminate at the expiration of

the 60 day notice period specified above.

(b) any software, hardware, or device, other than such Participant's

Contributor Version, directly or indirectly infringes any patent, then

any rights granted to You by such Participant under Sections 2.1(b)

and 2.2(b) are revoked effective as of the date You first made, used,

sold, distributed, or had made, Modifications made by that

Participant.

8.3. If You assert a patent infringement claim against Participant

alleging that such Participant's Contributor Version directly or

indirectly infringes any patent where such claim is resolved (such as

by license or settlement) prior to the initiation of patent

infringement litigation, then the reasonable value of the licenses

granted by such Participant under Sections 2.1 or 2.2 shall be taken

into account in determining the amount or value of any payment or

license.

8.4. In the event of termination under Sections 8.1 or 8.2 above,

all end user license agreements (excluding distributors and resellers)

which have been validly granted by You or any distributor hereunder

prior to termination shall survive termination.

UNDER NO CIRCUMSTANCES AND UNDER NO LEGAL THEORY, WHETHER TORT

(INCLUDING NEGLIGENCE), CONTRACT, OR OTHERWISE, SHALL YOU, THE INITIAL

DEVELOPER, ANY OTHER CONTRIBUTOR, OR ANY DISTRIBUTOR OF COVERED CODE,

OR ANY SUPPLIER OF ANY OF SUCH PARTIES, BE LIABLE TO ANY PERSON FOR

ANY INDIRECT, SPECIAL, INCIDENTAL, OR CONSEQUENTIAL DAMAGES OF ANY

CHARACTER INCLUDING, WITHOUT LIMITATION, DAMAGES FOR LOSS OF GOODWILL,

WORK STOPPAGE, COMPUTER FAILURE OR MALFUNCTION, OR ANY AND ALL OTHER

COMMERCIAL DAMAGES OR LOSSES, EVEN IF SUCH PARTY SHALL HAVE BEEN

INFORMED OF THE POSSIBILITY OF SUCH DAMAGES. THIS LIMITATION OF

LIABILITY SHALL NOT APPLY TO LIABILITY FOR DEATH OR PERSONAL INJURY

RESULTING FROM SUCH PARTY'S NEGLIGENCE TO THE EXTENT APPLICABLE LAW

PROHIBITS SUCH LIMITATION. SOME JURISDICTIONS DO NOT ALLOW THE

EXCLUSION OR LIMITATION OF INCIDENTAL OR CONSEQUENTIAL DAMAGES, SO

THIS EXCLUSION AND LIMITATION MAY NOT APPLY TO YOU.

The Covered Code is a "commercial item," as that term is defined in

48 C.F.R. 2.101 (Oct. 1995), consisting of "commercial computer

software" and "commercial computer software documentation," as such

terms are used in 48 C.F.R. 12.212 (Sept. 1995).

Consistent with 48

C.F.R. 12.212 and 48 C.F.R. 227.7202-1 through 227.7202-4 (June 1995),

all U.S. Government End Users acquire Covered Code with only those

rights set forth herein.

This License represents the complete agreement concerning subject

matter hereof. If any provision of this License is held to be

unenforceable, such provision shall be reformed only to the extent

necessary to make it enforceable. This License shall be governed by

California law provisions (except to the extent applicable law, if

any, provides otherwise), excluding its conflict-of-law provisions.

With respect to disputes in which at least one party is a citizen of,

or an entity chartered or registered to do business in the United

States of America, any litigation relating to this License shall be

subject to the jurisdiction of the Federal Courts of the Northern

District of California, with venue lying in Santa Clara County,

California, with the losing party responsible for costs, including

without limitation, court costs and reasonable attorneys' fees and

expenses. The application of the United Nations Convention on

Contracts for the International Sale of Goods is expressly excluded.

Any law or regulation which provides that the language of a contract

shall be construed against the drafter shall not apply to this

License.

As between Initial Developer and the Contributors, each party is

responsible for claims and damages arising,

directly or indirectly,

out of its utilization of rights under this License and You agree to

work with Initial Developer and Contributors to distribute such

responsibility on an equitable basis. Nothing herein is intended or

shall be deemed to constitute any admission of liability.

Initial Developer may designate portions of the Covered Code as

"Multiple-Licensed". "Multiple-Licensed" means that the Initial

Developer permits you to utilize portions of the Covered Code under

Your choice of the NPL or the alternative licenses, if any, specified

by the Initial Developer in the file described in Exhibit A.

EXHIBIT A -Mozilla Public License.

"The contents of this file are subject to the Mozilla Public License

Version 1.1 (the "License"); you may not use this file except in

compliance with the License. You may obtain a copy of the License at

<http://www.mozilla.org/MPL/>

Software distributed under the License is distributed on an "AS IS"

basis, WITHOUT WARRANTY OF ANY KIND, either express or implied. See the

License for the specific language governing rights and limitations

under the License.

The Original Code is _____.

The Initial Developer of the Original Code is _____.

Portions created by _____ are Copyright (C) _____. All Rights Reserved.

Contributor(s): _____.

Alternatively, the contents of this file may be used under the terms

of the _____ license (the "[_____] License"), in which case the

provisions of [_____] License are applicable instead of those

above. If you wish to allow use of your version of this file only

under the terms of the [_____] License and not to allow others to use

your version of this file under the MPL, indicate your decision by

deleting the provisions above and replace them with the notice and

other provisions required by the [_____] License. If you do not delete

the provisions above, a recipient may use your version of this file

under either the MPL or the [_____] License."

[NOTE: The text of this Exhibit A may differ slightly from the text of

the notices in the Source Code files of the Original Code. You should

use the text of this Exhibit A rather than the text found in the

Original Code Source Code for Your Modifications.]

Open Source

Android (7.1.1)

This tv contains the Android Nougat Software. Android is a Linux-based operating system designed primarily for touchscreen mobile devices such as smartphones and tablet computers. This software will also be reused in TPVision Android based TV's. The original download site for this software is : <https://android.google.com/>. This piece of software is made available under the terms and conditions of the Apache license version 2, which can be found below. Android APACHE License Version 2 (<http://source.android.com/source/licenses.html>). This includes all external sources used by official Android AOSP.

linux kernel (3.10.79)

This tv contains the Linux Kernel. The original download site for this software is : <http://www.kernel.org/>. This piece of software is made available under the terms and conditions of the GPL v2 license, which can be found below. Additionally, following exception applies: "NOTE! This copyright does *not* cover user programs that use kernel services by normal system calls - this is merely considered normal use of the kernel, and does *not* fall under the heading of "derived work". Also note that the GPL below is copyrighted by the Free Software Foundation, but the instance of code that it refers to (the linux kernel) is copyrighted by me and others who actually wrote it. Also note that the only valid version of the GPL as far as the kernel is concerned is _this_ particular version of the license (ie v2, not v2.2 or v3.x or whatever), unless explicitly otherwise stated. Linus Torvalds"

libcurl (7.50.1)

libcurl is a free and easy-to-use client-side URL transfer library, supporting DICT, FILE, FTP, FTPS, Gopher, HTTP, HTTPS, IMAP, IMAPS, LDAP, LDAPS, POP3, POP3S, RTMP, RTSP, SCP, SFTP, SMTP, SMTPS, Telnet and TFTP. libcurl supports SSL certificates, HTTP POST, HTTP PUT, FTP uploading, HTTP form based upload, proxies, cookies, user+password authentication (Basic, Digest, NTLM, Negotiate, Kerberos), file transfer resume, http proxy tunneling and more! The original download site for this software is : <http://curl.haxx.se/libcurl/>
COPYRIGHT AND PERMISSION NOTICE Copyright (c) 1996 - 2010, Daniel Stenberg, daniel@haxx.se. All rights reserved. Permission to use, copy, modify, and distribute this software for any purpose with or without fee is hereby granted, provided that the above copyright notice and this permission notice appear in all copies. THE SOFTWARE IS PROVIDED "AS IS", WITHOUT WARRANTY OF ANY KIND, EXPRESS OR IMPLIED, INCLUDING BUT NOT LIMITED TO THE WARRANTIES OF MERCHANTABILITY, FITNESS FOR A PARTICULAR PURPOSE AND NONINFRINGEMENT OF THIRD PARTY RIGHTS. IN NO EVENT SHALL THE AUTHORS OR COPYRIGHT HOLDERS BE LIABLE FOR ANY CLAIM, DAMAGES OR OTHER LIABILITY, WHETHER IN AN ACTION OF CONTRACT, TORT OR OTHERWISE, ARISING FROM, OUT OF OR IN CONNECTION WITH THE SOFTWARE OR THE USE OR OTHER DEALINGS IN THE SOFTWARE. Except as contained in this notice, the name of a copyright holder shall not be used in advertising or otherwise to promote the sale, use or other dealings in this Software without prior written authorization of the copyright holder.

libfreetypeex (2.4.2)

FreeType is a software development library, available

in source and binary forms, used to render text on to bitmaps and provides support for other font-related operations. The original download site for this software is :

<https://github.com/julienr/libfreetype-android>

Freetype License

libjpegex (8a)

This package contains C software to implement JPEG image encoding, decoding, and transcoding. This software is based in part on the work of the Independent JPEG Group.-----The authors make NO WARRANTY or representation, either express or implied, with respect to this software, its quality, accuracy, merchantability, or fitness for a particular purpose. This software is provided "AS IS", and you, its user, assume the entire risk as to its quality and accuracy. This software is copyright (C) 1991-1998, Thomas G. Lane. All Rights Reserved except as specified below. Permission is hereby granted to use, copy, modify, and distribute this software (or portions thereof) for any purpose, without fee, subject to these conditions:(1) If any part of the source code for this software is distributed, then this README file must be included, with this copyright and no-warranty notice unaltered; and any additions, deletions, or changes to the original files must be clearly indicated in accompanying documentation.(2) If only executable code is distributed, then the accompanying documentation must state that "this software is based in part on the work of the Independent JPEG Group".(3) Permission for use of this software is granted only if the user accepts full responsibility for any undesirable consequences; the authors accept NO LIABILITY for damages of any kind. These conditions apply to any software derived from or based on the IJG code, not just to the unmodified library. If you use our work, you ought to acknowledge us. Permission is NOT granted for the use of any IJG author's name or company name in advertising or publicity relating to this software or products derived from it. This software may be referred to only as "the Independent JPEG Group's software". We specifically permit and encourage the use of this software as the basis of commercial products, provided that all warranty or liability claims are assumed by the product vendor.

libpngex (1.4.1)

libpng is the official Portable Network Graphics (PNG) reference library (originally called pnglib). It is a platform-independent library that contains C functions for handling PNG images. It supports almost all of PNG's features, is extensible. The original download site for this software is :
<https://github.com/julienr/libpng-androidlibpng>
license

dvbsnoop (1.2)

dvbsnoop is a DVB / MPEG stream analyzer program. For generating CRC32 values required for composing PAT, PMT, EIT sections The original download site for this software is : <https://github.com/a4tunado/dvbsnoop/blob/master/src/misc/crc32.c>GPL v2
<http://dvbsnoop.sourceforge.net/dvbsnoop.html>

gSoap (2.7.15)

The gSOAP toolkit is an open source C and C++ software development toolkit for SOAP/XML Web services and generic (non-SOAP) C/C++ XML data bindings. Part of the software embedded in this product is gSOAP software. Portions created by gSOAP are Copyright 2001-2009 Robert A. van Engelen, Genivia inc. All Rights Reserved. THE SOFTWARE IN THIS PRODUCT WAS IN PART PROVIDED BY GENIVIA INC AND ANY EXPRESS OR IMPLIED WARRANTIES, INCLUDING, BUT NOT LIMITED TO, THE IMPLIED WARRANTIES OF MERCHANTABILITY AND FITNESS FOR A PARTICULAR PURPOSE ARE DISCLAIMED. IN NO EVENT SHALL THE AUTHOR BE LIABLE FOR ANY DIRECT, INDIRECT, INCIDENTAL, SPECIAL, EXEMPLARY, OR CONSEQUENTIAL DAMAGES (INCLUDING, BUT NOT LIMITED TO, PROCUREMENT OF SUBSTITUTE GOODS OR SERVICES; LOSS OF USE, DATA, OR PROFITS; OR BUSINESS INTERRUPTION) HOWEVER CAUSED AND ON ANY THEORY OF LIABILITY, WHETHER IN CONTRACT, STRICT LIABILITY, OR TORT (INCLUDING NEGLIGENCE OR OTHERWISE) ARISING IN ANY WAY OUT OF THE USE OF THIS SOFTWARE, EVEN IF ADVISED OF THE POSSIBILITY OF SUCH DAMAGE.

restlet (2.3.0)

Restlet is a lightweight, comprehensive, open source REST framework for the Java platform. Restlet is suitable for both server and client Web applications. It supports major Internet transport, data format, and service description standards like HTTP and HTTPS, SMTP, XML, JSON, Atom, and WADL. The original download site for this software is : <http://restlet.org>
This piece of software is made available under the terms and conditions of the Apache License version 2.

FaceBook SDK (3.0.1)

This TV contains Facebook SDK. The Facebook SDK for Android is the easiest way to integrate your Android app with Facebook's platform. The SDK provides support for Login with Facebook authentication, reading and writing to Facebook APIs and support for UI elements such as pickers and dialogs. The original download site for this software is

: <https://developer.facebook.com/docs/android> This piece of software is made available under the terms and conditions of the Apache License version 2.

ffmpeg (2.1.3)

This TV uses FFmpeg. FFmpeg is a complete, cross-platform solution to record, convert and stream audio and video. The original download site for this software is : <http://ffmpeg.org> This piece of software is made available under the terms and conditions of the GPL v2 license, which can be found below.

gson (2.3)

This TV uses gson. Gson is a Java library that can be used to convert Java Objects into their JSON representation. It can also be used to convert a JSON string to an equivalent Java object. Gson can work with arbitrary Java objects including pre-existing objects that you do not have source-code of. The original download site for this software is : <https://code.google.com/p/google-gson/> . This piece of software is made available under the terms and conditions of the Apache License 2.0

This software includes an implementation of the AES Cipher, licensed by Brian Gladman. The original download site for this software is : <http://www.gladman.me.uk/> This piece of software is licensed by Brian Gladman.

libUpNp (1.2.1)

The original download site for this software is : <http://upnp.sourceforge.net/> This piece of software is made available under the terms and conditions of the BSD.

live555 (0.82)

Live555 provides RTP/RTCP/RTSP client. The original download site for this software is : <http://www.live555.com> This piece of software is made available under the terms and conditions of the LGPL v2.1 license, which can be found below.

dnsmasq

Dnsmasq is a lightweight, easy to configure DNS forwarder and DHCP server. The original download site for this software is : <https://android.googlesource.com/platform/external/dnsmasq> This piece of software is made available under the terms and conditions of the GPL v2 license, which can be found below.

TomCrypt (1.1)

iwedia stack is using tomcrypt for sw decryption. The original download site for this software is : <http://manpages.ubuntu.com/manpages/saucy/man3/libtomcrypt.3.html> This piece of software is made available under the terms and conditions of the DO WHAT THE FUCK YOU WANT TO PUBLIC LICENSE.

u-boot (2011-12)

U-boot is a boot loader for embedded boards based on ARM, MIPS and other processors, which can be installed in a boot ROM and used to initialize and test the hardware or to download and run application code. This piece of software is made available under the terms and conditions of the GPL v2 license, which can be found below.

AsyncHttpClient (1.4.9)

The original download site for this software is : <http://loopj.com/android-async-http/> This piece of software is made available under the terms and conditions of the APACHE LICENSE 2.0

httpClient-4.4.1.1 (4.4.1.1)

This is needed to import cz.msebera.android.httpClient used by AssyncHttpClient The original download site for this software is : <http://mvnrepository.com/artifact/cz.msebera.android/httpclient/4.4.1.1> This piece of software is made available under the terms and conditions of the APACHE LICENSE 2.0

Jackson Parser (2.x)

lpepg client uses Jackson Parser for string manipulation. The original download site for this software is : <https://github.com/FasterXML/jackson-core> This piece of software is made available under the terms and conditions of the APACHE LICENSE 2.0

audio a2dp (2.x)

Bluetooth stack. The original download site for this software is : https://android.googlesource.com/platform/system_bt This piece of software is made available under the terms and conditions of the APACHE LICENSE 2.0

libexif (0.6.21)

Exif JPEG header manipulation tool. The original download site for this software is :

<http://libexif.sourceforge.net/> This piece of software is made available under the terms and conditions of the APACHE LICENSE 2.0

libexpat (2.1.0)

Expat XML Parser. The original download site for this software is : <http://www.libexpat.org/Expat> is free software. You may copy, distribute, and modify it under the terms of the License contained in the file COPYING distributed with this package. This license is the same as the MIT/X Consortium license.

libFFTEm ()

neven face recognition library. The original download site for this software is : No info. This piece of software is made available under the terms and conditions of the APACHE LICENSE 2.0

libcui18n (49.1.1)

International Components for unicode. The original download site for this software is : <http://icu-project.org> This piece of software is made available under the terms and conditions of the BSD.

libprouteutil (3.4.0)

iproute2 TCP/IP networking and traffic control. The original download site for this software is : <http://www.linuxfoundation.org/> This piece of software is made available under the terms and conditions of the GPL v2. which can be found below

libjpeg (3.4.0)

libjpeg-turbo is a JPEG image codec that uses SIMD instructions (MMX, SSE2, NEON) to accelerate baseline JPEG compression and decompression on x86, x86-64, and ARM systems. The original download site for this software is : <http://www.ijg.org/libjpeg-turbo> is covered by three compatible BSD-style open source licenses. Refer to LICENSE.txt for a roll-up of license terms.

libmtp (1.0.1)

libmtp The original download site for this software is : <http://libmtp.sourceforge.net/> . This piece of software is made available under the terms and conditions of the LGPL V2.

libmdnssd (320.10.80)

MDNS Responder. The mDNSResponder project is a component of Bonjour, 5Apple's ease-of-use IP

networking initiative. The original download site for this software is :

<http://www.opensource.apple.com/tarballs/mDNSResponder/> This piece of software is made available under the terms and conditions of the Apache license version 2

libnfc_ndef ()

The original download site for this software is : No info. This piece of software is made available under the terms and conditions of the Apache license version 2

libskia ()

skia 2D graphics library Skia is a complete 2D graphic library for drawing Text, Geometries, and Images. The original download site for this software is : <http://code.google.com/p/skia/> This piece of software is made available under the terms and conditions of the BSD.

libsonivox ()

The original download site for this software is : No info. This piece of software is made available under the terms and conditions of the Android APACHE License Version 2.

libsqlite (3.9.2)

SQLite database. The original download site for this software is : <http://www.sqlite.org> This piece of software is made available under the terms and conditions of the Android APACHE License Version 2.

libttspeco ()

The original download site for this software is : No info. This piece of software is made available under the terms and conditions of the Android APACHE License Version 2.

libtinyalsa ()

tinyalsa: a small library to interface with ALSA in the Linux kernel. The original download site for this software is : No info. This piece of software is made available under the terms and conditions of the BSD.

wpa_supplicant (0.8)

Library used by legacy HAL to talk to wpa_supplicant daemon. The original download site for this software is : <http://hostap.epitest.fi/> This piece of software is made available under the terms and conditions of the

GPLv2.

libz (1.2.8)

zlib compression library. The original download site for this software is : <http://zlib.net> This piece of software is made available under the terms and conditions of the BSD.

iptables (1.4.20)

iptables is a user space application program that allows a system administrator to configure the tables provided by the Linux kernel firewall (implemented as different Netfilter modules) and the chains and rules it stores. Different kernel modules and programs are currently used for different protocols; iptables applies to IPv4The original download site for this software is : <https://android.googlesource.com/> This piece of software is made available under the terms and conditions of the GPLv2.

toolbox (1.2.8)

The 'toolbox' command in Android is a multi-function program. It encapsulates the functionality of many common Linux commands (and some special Android ones) into a single binary. This makes it more compact than having all those other commands installed individually. The original download site for this software is : <https://android.googlesource.com/> This piece of software is made available under the terms and conditions of the Android APACHE License Version 2.

libssl
(7b8b9c17db93ea5287575b437c77fb36eeb81b31)

BoringSSL The original download site for this software is : <https://boringssl.googlesource.com/boringssl/> This piece of software is made available under the terms and conditions of the BSD.

libOpenMAXAL
(7b8b9c17db93ea5287575b437c77fb36eeb81b31)

OpenMAX AL is an application-level multimedia playback and recording API for mobile embedded devicesThe original download site for this software is : <https://www.khronos.org/openmax/> License free

libOpenSLES (1.0)

Khronos OpenSL Sound API spec. The original download site for this software is : <https://www.khronos.org/opensles/> License free

libEGL libGLESv1_CM (3.1)

Khronos OpenGL Graphics API spec. The original download site for this software is : <https://www.opengl.org/> License free

libffmpeg_av (2.1)

FFmpeg media player. The original download site for this software is : <https://ffmpeg.org/> This piece of software is licensed under LGPL v2.1

libcurlmheg (7.21.6)

curl for MHEG. The original download site for this software is : <https://ffmpeg.org/> Curl and libcurl are licensed under a MIT/X derivate license. Please look at <https://curl.haxx.se/docs/copyright.html>

boringsssl
(af0e32cb84f0c9cc65b9233a3414d2562642b342)

ssl for MHEG, Taken from android M. The original download site for this software is : <https://boringssl.googlesource.com/boringssl/> Licensed under BSD, please find in /android/n-base/external/boringssl/NOTICE

libpng (1.6.22beta)

libpng is the official Portable Network Graphics (PNG) reference library (originally called pnglib). It is a platform-independent library that contains C functions for handling PNG images. It supports almost all of PNG's features, is extensible. The original download site for this software is : <https://github.com/julienr/libpng-android> This code is released under the libpng license.

Hue SDK (1.8.1)

TV ambihue app uses Philips SDK to find the hue bridge name. The original download site for this software is : <https://developers.meethue.com/documentation/java-multi-platform-and-android-sdk>

Opera Web Browser (SDK 4.8.0)

This TV contains Opera Browser Software.

Third-party licenses

WebKit

name License

WebKit URL: <http://webkit.org/>

(WebKit doesn't distribute an explicit license. This LICENSE is derived from license text in the source.)

Copyright (c) 1997, 1998, 1999, 2000, 2001, 2002, 2003, 2004, 2005, 2006, 2007 Alexander Kellett, Alexey Proskuryakov, Alex Mathews, Allan Sandfeld Jensen, Alp Toker, Anders Carlsson, Andrew Wellington, Antti Koivisto, Apple Inc., Arthur Langereis, Baron Schwartz, Bjoern Graf, Brent Fulgham, Cameron Zwarich, Charles Samuels, Christian Dywan, Collabora Ltd., Cyrus Patel, Daniel Molkentin, Dave MacLachlan, David Smith, Dawit Alemayehu, Dirk Mueller, Dirk Schulze, Don Gibson, Enrico Ros, Eric Seidel, Frederik Holljen, Frerich Raabe, Friedmann Kleint, George Staikos, Google Inc., Graham Dennis, Harri Porten, Henry Mason, Hiroyuki Ikezoe, Holger Hans Peter Freyther, IBM, James G. Speth, Jan Alonzo, Jean-Loup Gailly, John Reis, Jonas Witt, Jon Shier, Jonas Witt, Julien Chaffraix, Justin Haygood, Kevin Ollivier, Kevin Watters, Kimmo Kinnunen, Kouhei Sutou, Krzysztof Kowalczyk, Lars Knoll, Luca Bruno, Maks Orlovich, Malte Starostik, Mark Adler, Martin Jones, Marvin Decker, Matt Lilek, Michael Emmel, Mitz Pettel, mozilla.org, Netscape Communications Corporation, Nicholas Shanks, Nikolas Zimmermann, Nokia, Oliver Hunt, Opened Hand, Paul Johnston, Peter Kelly, Pioneer Research Center USA, Rich Moore, Rob Buis, Robin Dunn, Ronald Tschalär, Samuel Weinig, Simon Hausmann, Staikos Computing Services Inc., Stefan Schimanski, Symantec Corporation, The Dojo Foundation, The Karbon Developers, Thomas Boyer, Tim Copperfield, Tobias Anton, Torben Weis, Trolltech, University of Cambridge, Vaclav Slavik, Waldo Bastian, Xan Lopez, Zack Rusin

The terms and conditions vary from file to file, but are one of:

Redistribution and use in source and binary forms, with or without modification, are permitted provided that the following conditions are met:

OR

Redistribution and use in source and binary forms, with or without modification, are permitted provided that the following conditions are met:

THIS SOFTWARE IS PROVIDED BY APPLE COMPUTER, INC. "AS IS" AND ANY EXPRESS OR IMPLIED WARRANTIES, INCLUDING, BUT NOT LIMITED TO, THE IMPLIED WARRANTIES OF MERCHANTABILITY AND FITNESS FOR A PARTICULAR PURPOSE ARE DISCLAIMED. IN NO EVENT SHALL APPLE COMPUTER, INC. OR CONTRIBUTORS BE LIABLE FOR ANY DIRECT, INDIRECT, INCIDENTAL, SPECIAL, EXEMPLARY, OR CONSEQUENTIAL DAMAGES (INCLUDING, BUT NOT

LIMITED TO, PROCUREMENT OF SUBSTITUTE GOODS OR SERVICES; LOSS OF USE, DATA, OR PROFITS; OR BUSINESS INTERRUPTION) HOWEVER CAUSED AND ON ANY THEORY OF LIABILITY, WHETHER IN CONTRACT, STRICT LIABILITY, OR TORT (INCLUDING NEGLIGENCE OR OTHERWISE) ARISING IN ANY WAY OUT OF THE USE OF THIS SOFTWARE, EVEN IF ADVISED OF THE POSSIBILITY OF SUCH DAMAGE.

GNU LIBRARY GENERAL PUBLIC LICENSE

Version 2, June 1991

Copyright (C) 1991 Free Software Foundation, Inc.

51 Franklin Street, Fifth Floor, Boston, MA 02110-1301 USA

Everyone is permitted to copy and distribute verbatim copies of this license document, but changing it is not allowed.

Preamble

The licenses for most software are designed to take away your freedom to share and change it. By contrast, the GNU General Public Licenses are intended to guarantee your freedom to share and change free software--to make sure the software is free for all its users.

This license, the Library General Public License, applies to some specially designated Free Software Foundation software, and to any other libraries whose authors decide to use it. You can use it for your libraries, too.

When we speak of free software, we are referring to freedom, not price. Our General Public Licenses are designed to make sure that you have the freedom to distribute copies of free software (and charge for this service if you wish), that you receive source code or can get it if you want it, that you can change the software or use pieces of it in new free programs; and that you know you can do these things.

To protect your rights, we need to make restrictions that forbid anyone to deny you these rights or to ask you to surrender the rights. These restrictions translate to certain responsibilities for you if you distribute copies of the library, or if you modify it.

For example, if you distribute copies of the library, whether gratis or for a fee, you must give the recipients all the rights that we gave you. You must make sure that they, too, receive or can get the source code. If you link a program with the library, you must provide complete object files to the recipients so that they can relink them with the library, after making changes to the library and recompiling it. And you must show them these terms so they know their rights.

Our method of protecting your rights has two steps:

(1) copyright the library, and (2) offer you this license which gives you legal permission to copy, distribute and/or modify the library.

Also, for each distributor's protection, we want to make certain that everyone understands that there is no warranty for this free library. If the library is modified by someone else and passed on, we want its recipients to know that what they have is not the original version, so that any problems introduced by others will not reflect on the original authors' reputations.

Finally, any free program is threatened constantly by software patents. We wish to avoid the danger that companies distributing free software will individually obtain patent licenses, thus in effect transforming the program into proprietary software. To prevent this, we have made it clear that any patent must be licensed for everyone's free use or not licensed at all.

Most GNU software, including some libraries, is covered by the ordinary GNU General Public License, which was designed for utility programs. This license, the GNU Library General Public License, applies to certain designated libraries. This license is quite different from the ordinary one; be sure to read it in full, and don't assume that anything in it is the same as in the ordinary license.

The reason we have a separate public license for some libraries is that they blur the distinction we usually make between modifying or adding to a program and simply using it. Linking a program with a library, without changing the library, is in some sense simply using the library, and is analogous to running a utility program or application program. However, in a textual and legal sense, the linked executable is a combined work, a derivative of the original library, and the ordinary General Public License treats it as such.

Because of this blurred distinction, using the ordinary General Public License for libraries did not effectively promote software sharing, because most developers did not use the libraries. We concluded that weaker conditions might promote sharing better.

However, unrestricted linking of non-free programs would deprive the users of those programs of all benefit from the free status of the libraries themselves. This Library General Public License is intended to permit developers of non-free programs to use free libraries, while preserving your freedom as a user of such programs to change the free libraries that are incorporated in them. (We have not seen how to achieve this as regards changes in header files, but we have achieved it as regards changes in the actual functions of the Library.) The hope is that this will lead to faster development of free libraries.

The precise terms and conditions for copying, distribution and modification follow. Pay close attention to the difference between a "work based on

the library" and a "work that uses the library". The former contains code derived from the library, while the latter only works together with the library.

Note that it is possible for a library to be covered by the ordinary General Public License rather than by this special one.

GNU LIBRARY GENERAL PUBLIC LICENSE

TERMS AND CONDITIONS FOR COPYING, DISTRIBUTION AND MODIFICATION

0. This License Agreement applies to any software library which contains a notice placed by the copyright holder or other authorized party saying it may be distributed under the terms of this Library General Public License (also called "this License"). Each licensee is addressed as "you".

A "library" means a collection of software functions and/or data prepared so as to be conveniently linked with application programs (which use some of those functions and data) to form executables.

The "Library", below, refers to any such software library or work which has been distributed under these terms. A "work based on the Library" means either the Library or any derivative work under copyright law: that is to say, a work containing the Library or a portion of it, either verbatim or with modifications and/or translated straightforwardly into another language. (Hereinafter, translation is included without limitation in the term "modification".)

"Source code" for a work means the preferred form of the work for making modifications to it. For a library, complete source code means all the source code for all modules it contains, plus any associate interface definition files, plus the scripts used to control compilation and installation of the library.

Activities other than copying, distribution and modification are not covered by this License; they are outside its scope. The act of running a program using the Library is not restricted, and output from such a program is covered only if its contents constitute a work based on the Library (independent of the use of the Library in a tool for writing it). Whether that is true depends on what the Library does and what the program that uses the Library does.

1. You may copy and distribute verbatim copies of the Library's complete source code as you receive it, in any medium, provided that you conspicuously and appropriately publish on each copy an appropriate copyright notice and disclaimer of warranty; keep

intact all the notices that refer to this License and to the absence of any warranty; and distribute a copy of this License along with the

You may charge a fee for the physical act of transferring a copy, and you may at your option offer warranty protection in exchange for a

2. You may modify your copy or copies of the Library or any portion of it, thus forming a work based on the Library, and copy and distribute such modifications or work under the terms of Section 1 above, provided that you also meet all of these conditions:

a) The modified work must itself be a software library.

b) You must cause the files modified to carry prominent notices stating that you changed the files and the date of any change.

c) You must cause the whole of the work to be licensed at no charge to all third parties under the terms of this License.

d) If a facility in the modified Library refers to a function or a table of data to be supplied by an application program that uses the facility, other than as an argument passed when the facility is invoked, then you must make a good faith effort to ensure that, in the event an application does not supply such function or table, the facility still operates, and performs whatever part of its purpose remains meaningful.

(For example, a function in a library to compute square roots has a purpose that is entirely well-defined independent of the application. Therefore, Subsection 2d requires that any application-supplied function or table used by this function must be optional: if the application does not supply it, the squareroot function must still compute square roots.)

These requirements apply to the modified work as a whole. If identifiable sections of that work are not derived from the Library, and can be reasonably considered independent and separate works in themselves, then this License, and its terms, do not apply to those sections when you distribute them as separate works. But when you distribute the same sections as part of a whole which is a work based on the Library, the distribution of the whole must be on the terms of this License, whose permissions for other licensees extend to the entire whole, and thus to each and every part regardless of who wrote. Thus, it is not the intent of this section to claim rights or contest your rights to work written entirely by you; rather, the intent is to exercise the right to control the distribution of derivative or collective works based on the Library.

In addition, mere aggregation of another work not based on the Library with the Library (or with a work based on the Library) on a volume of a storage or distribution medium does not bring the other work

under the scope of this License.

3. You may opt to apply the terms of the ordinary GNU General Public License instead of this License to a given copy of the Library. To do this, you must alter all the notices that refer to this License, so that they refer to the ordinary GNU General Public License, version 2, instead of to this License. (If a newer version than version 2 of the ordinary GNU General Public License has appeared, then you can specify that version instead if you wish.) Do not make any other change in these notices.

Once this change is made in a given copy, it is irreversible for that copy, so the ordinary GNU General Public License applies to all subsequent copies and derivative works made from that copy.

This option is useful when you wish to copy part of the code of the Library into a program that is not a library.

4. You may copy and distribute the Library (or a portion or derivative of it, under Section 2) in object code or executable form under the terms of Sections 1 and 2 above provided that you accompany it with the complete corresponding machine-readable source code, which must be distributed under the terms of Sections 1 and 2 above on a medium customarily used for software interchange.

If distribution of object code is made by offering access to copy from a designated place, then offering equivalent access to copy the source code from the same place satisfies the requirement to distribute the source code, even though third parties are not compelled to copy the source along with the object code.

5. A program that contains no derivative of any portion of the Library, but is designed to work with the Library by being compiled or linked with it, is called a "work that uses the Library". Such a work, in isolation, is not a derivative work of the Library, and therefore falls outside the scope of this License.

However, linking a "work that uses the Library" with the Library creates an executable that is a derivative of the Library (because it contains portions of the Library), rather than a "work that uses the library". The executable is therefore covered by this License.

Section 6 states terms for distribution of such executables.

When a "work that uses the Library" uses material from a header file that is part of the Library, the object code for the work may be a derivative work of the Library even though the source code is not. Whether this is true is especially significant if the work can be linked without the Library, or if the work is itself a library. The threshold for this to be true is not precisely defined by law.

If such an object file uses only numerical parameters, data structure layouts and accessors, and small macros and small inline functions (ten lines or less in length), then the use of the object file is unrestricted, regardless of whether it is legally a derivative work. (Executables containing this object code plus portions of the Library will still fall under Section 6.)

Otherwise, if the work is a derivative of the Library, you may distribute the object code for the work under the terms of Section 6. Any executables containing that work also fall under Section 6, whether or not they are linked directly with the Library itself.

6. As an exception to the Sections above, you may also compile or link a "work that uses the Library" with the Library to produce a work containing portions of the Library, and distribute that work under terms of your choice, provided that the terms permit modification of the work for the customer's own use and reverse engineering for debugging such modifications.

You must give prominent notice with each copy of the work that the Library is used in it and that the Library and its use are covered by this License. You must supply a copy of this License. If the work during execution displays copyright notices, you must include the copyright notice for the Library among them, as well as a reference directing the user to the copy of this License. Also, you must do one of these things:

a) Accompany the work with the complete corresponding machine-readable source code for the Library including whatever changes were used in the work (which must be distributed under Sections 1 and 2 above); and, if the work is an executable linked with the Library, with the complete machine-readable "work that uses the Library", as object code and/or source code, so that the user can modify the Library and then relink to produce a modified executable containing the modified Library. (It is understood that the user who changes the contents of definitions files in the Library will not necessarily be able to recompile the application to use the modified definitions.)

b) Accompany the work with a written offer, valid for at least three years, to give the same user the materials specified in Subsection 6a, above, for a charge no more than the cost of performing this distribution.

c) If distribution of the work is made by offering access to copy from a designated place, offer equivalent access to copy the above specified materials from the same place.

d) Verify that the user has already received a copy of these materials or that you have already sent this user a copy.

For an executable, the required form of the "work that uses the Library" must include any data and utility programs needed for reproducing the executable from it. However, as a special exception, the source code distributed need not include anything that is normally distributed (in either source or binary form) with the major components (compiler, kernel, and so on) of the operating system on which the executable runs, unless that component itself accompanies the executable.

It may happen that this requirement contradicts the license restrictions of other proprietary libraries that do not normally accompany the operating system. Such a contradiction means you cannot use both them and the Library together in an executable that you distribute.

7. You may place library facilities that are a work based on the Library side-by-side in a single library together with other library facilities not covered by this License, and distribute such a combined library, provided that the separate distribution of the work based on the Library and of the other library facilities is otherwise permitted, and provided that you do these two things:

a) Accompany the combined library with a copy of the same work based on the Library, uncombined with any other library facilities. This must be distributed under the terms of the Sections above.

b) Give prominent notice with the combined library of the fact that part of it is a work based on the Library, and explaining where to find the accompanying uncombined form of the same work.

8. You may not copy, modify, sublicense, link with, or distribute the Library except as expressly provided under this License. Any attempt otherwise to copy, modify, sublicense, link with, or distribute the Library is void, and will automatically terminate your rights under this License. However, parties who have received copies, or rights, from you under this License will not have their licenses terminated so long as such parties remain in full compliance.

9. You are not required to accept this License, since you have not signed it. However, nothing else grants you permission to modify or distribute the Library or its derivative works. These actions are prohibited by law if you do not accept this License. Therefore, by modifying or distributing the Library (or any work based on the Library), you indicate your acceptance of this License to do so, and all its terms and conditions for copying, distributing or modifying the Library or works based on it.

10. Each time you redistribute the Library (or any work based on the Library), the recipient automatically receives a license from the original licensor to copy,

distribute, link with or modify the Library subject to these terms and conditions. You may not impose any further restrictions on the recipients' exercise of the rights granted herein. You are not responsible for enforcing compliance by third parties to this License.

11. If, as a consequence of a court judgment or allegation of patent infringement or for any other reason (not limited to patent issues), conditions are imposed on you (whether by court order, agreement or otherwise) that contradict the conditions of this License, they do not excuse you from the conditions of this License. If you cannot distribute so as to satisfy simultaneously your obligations under this License and any other pertinent obligations, then as a consequence you may not distribute the Library at all. For example, if a patent license would not permit royalty-free redistribution of the Library by all those who receive copies directly or indirectly through you, then the only way you could satisfy both it and this License would be to refrain entirely from distribution of the Library.

If any portion of this section is held invalid or unenforceable under any particular circumstance, the balance of the section is intended to apply, and the section as a whole is intended to apply in other circumstances.

It is not the purpose of this section to induce you to infringe any patents or other property right claims or to contest validity of any such claims; this section has the sole purpose of protecting the integrity of the free software distribution system which is implemented by public license practices. Many people have made generous contributions to the wide range of software distributed through that system in reliance on consistent application of that system; it is up to the author/donor to decide if he or she is willing to distribute software through any other system and a licensee cannot impose that choice.

This section is intended to make thoroughly clear what is believed to be a consequence of the rest of this License.

12. If the distribution and/or use of the Library is restricted in certain countries either by patents or by copyrighted interfaces, the original copyright holder who places the Library under this License may add an explicit geographical distribution limitation excluding those countries, so that distribution is permitted only in or among countries not thus excluded. In such case, this License incorporates the limitation as if written in the body of this License.

13. The Free Software Foundation may publish revised and/or new versions of the Library General Public License from time to time. Such new versions will be similar in spirit to the present version, but may differ in detail to address new problems or concerns. Each version is given a distinguishing version

number. If the Library specifies a version number of this License which applies to it and "any later version", you have the option of following the terms and conditions either of that version or of any later version published by the Free Software Foundation. If the Library does not specify a license version number, you may choose any version ever published by the Free Software Foundation.

14. If you wish to incorporate parts of the Library into other free programs whose distribution conditions are incompatible with these, write to the author to ask for permission. For software which is copyrighted by the Free Software Foundation, write to the Free Software Foundation; we sometimes make exceptions for this. Our decision will be guided by the two goals of preserving the free status of all derivatives of our free software and of promoting the sharing and reuse of software generally.

NO WARRANTY

15. BECAUSE THE LIBRARY IS LICENSED FREE OF CHARGE, THERE IS NO

WARRANTY FOR THE LIBRARY, TO THE EXTENT PERMITTED BY APPLICABLE LAW.

EXCEPT WHEN OTHERWISE STATED IN WRITING THE COPYRIGHT HOLDERS AND/OR

OTHER PARTIES PROVIDE THE LIBRARY "AS IS" WITHOUT WARRANTY OF ANY

KIND, EITHER EXPRESSED OR IMPLIED, INCLUDING, BUT NOT LIMITED TO, THE

IMPLIED WARRANTIES OF MERCHANTABILITY AND FITNESS FOR A PARTICULAR PURPOSE.

THE ENTIRE RISK AS TO THE QUALITY AND PERFORMANCE OF THE

LIBRARY IS WITH YOU. SHOULD THE LIBRARY PROVE DEFECTIVE, YOU ASSUME

THE COST OF ALL NECESSARY SERVICING, REPAIR OR CORRECTION.

16. IN NO EVENT UNLESS REQUIRED BY APPLICABLE LAW OR AGREED TO IN

WRITING WILL ANY COPYRIGHT HOLDER, OR ANY OTHER PARTY WHO MAY MODIFY

AND/OR REDISTRIBUTE THE LIBRARY AS PERMITTED ABOVE, BE LIABLE TO YOU

FOR DAMAGES, INCLUDING ANY GENERAL, SPECIAL, INCIDENTAL OR

CONSEQUENTIAL DAMAGES ARISING OUT OF THE USE OR INABILITY TO USE THE

LIBRARY (INCLUDING BUT NOT LIMITED TO LOSS OF DATA OR DATA BEING

RENDERED INACCURATE OR LOSSES SUSTAINED BY YOU OR THIRD PARTIES OR A FAILURE OF THE LIBRARY TO OPERATE WITH ANY OTHER SOFTWARE), EVEN IF SUCH HOLDER OR OTHER PARTY HAS BEEN ADVISED OF THE POSSIBILITY OF SUCH

END OF TERMS AND CONDITIONS

GNU LESSER GENERAL PUBLIC LICENSE

Version 2.1, February 1999

Copyright (C) 1991, 1999 Free Software Foundation, Inc.

51 Franklin Street, Fifth Floor, Boston, MA 02110-1301 USA

Everyone is permitted to copy and distribute verbatim copies of this license document, but changing it is not allowed.

[This is the first released version of the Lesser GPL. It also counts as the successor of the GNU Library Public License, version 2, hence the version number 2.1.]

Preamble

The licenses for most software are designed to take away your freedom to share and change it. By contrast, the GNU General Public Licenses are intended to guarantee your freedom to share and change free software--to make sure the software is free for all its users.

This license, the Lesser General Public License, applies to some specially designated software packages--typically libraries--of the Free Software Foundation and other authors who decide to use it. You can use it too, but we suggest you first think carefully about whether this license or the ordinary General Public License is the better strategy to use in any particular case, based on the explanations below.

When we speak of free software, we are referring to freedom of use, not price. Our General Public Licenses are designed to make sure that you have the freedom to distribute copies of free software (and charge for this service if you wish); that you receive source code or can get it if you want it; that you can change the software and use pieces of it in new free programs; and that you are informed that you can do these things.

To protect your rights, we need to make restrictions that forbid distributors to deny you these rights or to ask you to surrender these rights. These restrictions translate to certain responsibilities for you if you distribute copies of the library or if you modify it.

For example, if you distribute copies of the library, whether gratis or for a fee, you must give the recipients all the rights that we gave you. You must make sure that they, too, receive or can get the source code. If you link other code with the library, you must provide complete object files to the recipients, so that they can relink them with the library after making changes to the library and recompiling it. And you must show them these terms so they know their rights.

We protect your rights with a two-step method: (1) we copyright the library, and (2) we offer you this license, which gives you legal permission to copy, distribute and/or modify the library.

To protect each distributor, we want to make it very clear that there is no warranty for the free library. Also, if the library is modified by someone else and passed on, the recipients should know that what they have is not the original version, so that the original author's reputation will not be affected by problems that might be introduced by others.

Finally, software patents pose a constant threat to the existence of any free program. We wish to make sure that a company cannot effectively restrict the users of a free program by obtaining a restrictive license from a patent holder. Therefore, we insist that any patent license obtained for a version of the library must be consistent with the full freedom of use specified in this license.

Most GNU software, including some libraries, is covered by the ordinary GNU General Public License. This license, the GNU Lesser General Public License, applies to certain designated libraries, and is quite different from the ordinary General Public License. We use this license for certain libraries in order to permit linking those libraries into non-free programs.

When a program is linked with a library, whether statically or using a shared library, the combination of the two is legally speaking a combined work, a derivative of the original library. The ordinary General Public License therefore permits such linking only if the entire combination fits its criteria of freedom. The Lesser General Public License permits more lax criteria for linking other code with the library.

We call this license the "Lesser" General Public License because it does Less to protect the user's freedom than the ordinary General Public License. It also provides other free software developers Less of an advantage over competing non-free programs. These disadvantages are the reason we use the ordinary General Public License for many libraries. However, the Lesser license provides advantages in certain special circumstances.

For example, on rare occasions, there may be a special need to encourage the widest possible use of

a certain library, so that it becomes a de-facto standard. To achieve this, non-free programs must be allowed to use the library. A more frequent case is that a free library does the same job as widely used non-free libraries. In this case, there is little to gain by limiting the free library to free software only, so we use the Lesser General Public License.

In other cases, permission to use a particular library in non-free programs enables a greater number of people to use a large body of free software. For example, permission to use the GNU C Library in non-free programs enables many more people to use the whole GNU operating system, as well as its variant, the GNU/Linux operating system.

Although the Lesser General Public License is less protective of the users' freedom, it does ensure that the user of a program that is linked with the Library has the freedom and the wherewithal to run that program using a modified version of the Library.

The precise terms and conditions for copying, distribution and modification follow. Pay close attention to the difference between a "work based on the library" and a "work that uses the library". The former contains code derived from the library, whereas the latter must be combined with the library in order to run.

GNU LESSER GENERAL PUBLIC LICENSE

TERMS AND CONDITIONS FOR COPYING, DISTRIBUTION AND MODIFICATION

0. This License Agreement applies to any software library or other program which contains a notice placed by the copyright holder or other authorized party saying it may be distributed under the terms of this Lesser General Public License (also called "this License"). Each licensee is addressed as "you".

A "library" means a collection of software functions and/or data prepared so as to be conveniently linked with application programs (which use some of those functions and data) to form executables.

The "Library", below, refers to any such software library or work which has been distributed under these terms. A "work based on the Library" means either the Library or any derivative work under copyright law: that is to say, a work containing the Library or a portion of it, either verbatim or with modifications and/or translated straightforwardly into another language. (Hereinafter, translation is included without limitation in the term "modification".)

"Source code" for a work means the preferred form of the work for making modifications to it. For a library, complete source code means all the source code for

all modules it contains, plus any associated interface definition files, plus the scripts used to control compilation and installation of the library.

Activities other than copying, distribution and modification are not covered by this License; they are outside its scope. The act of running a program using the Library is not restricted, and output from such a program is covered only if its contents constitute a work based on the Library (independent of the use of the Library in a tool for writing it). Whether that is true depends on what the Library does and what the program that uses the Library does.

1. You may copy and distribute verbatim copies of the Library's complete source code as you receive it, in any medium, provided that you conspicuously and appropriately publish on each copy an appropriate copyright notice and disclaimer of warranty; keep intact all the notices that refer to this License and to the absence of any warranty; and distribute a copy of this License along with the Library.

You may charge a fee for the physical act of transferring a copy, and you may at your option offer warranty protection in exchange for a fee.

2. You may modify your copy or copies of the Library or any portion of it, thus forming a work based on the Library, and copy and distribute such modifications or work under the terms of Section 1 above, provided that you also meet all of these conditions:

a) The modified work must itself be a software library.

b) You must cause the files modified to carry prominent notices stating that you changed the files and the date of any change.

c) You must cause the whole of the work to be licensed at no charge to all third parties under the terms of this License.

d) If a facility in the modified Library refers to a function or a table of data to be supplied by an application program that uses the facility, other than as an argument passed when the facility is invoked, then you must make a good faith effort to ensure that, in the event an application does not supply such function or table, the facility still operates, and performs whatever part of its purpose remains meaningful.

(For example, a function in a library to compute square roots has a purpose that is entirely well-defined independent of the application. Therefore, Subsection 2d requires that any application-supplied function or table used by this function must be optional: if the application does not supply it, the square root function must still compute square roots.)

These requirements apply to the modified work as a

whole. If identifiable sections of that work are not derived from the Library, and can be reasonably considered independent and separate works in themselves, then this License, and its terms, do not apply to those sections when you distribute them as separate works. But when you distribute the same sections as part of a whole which is a work based on the Library, the distribution of the whole must be on the terms of this License, whose permissions for other licensees extend to the entire whole, and thus to each and every part regardless of who wrote

Thus, it is not the intent of this section to claim rights or contest your rights to work written entirely by you; rather, the intent is to exercise the right to control the distribution of derivative or collective works based on the Library.

In addition, mere aggregation of another work not based on the Library with the Library (or with a work based on the Library) on a volume of a storage or distribution medium does not bring the other work under the scope of this License.

3. You may opt to apply the terms of the ordinary GNU General Public License instead of this License to a given copy of the Library. To do this, you must alter all the notices that refer to this License, so that they refer to the ordinary GNU General Public License, version 2, instead of to this License. (If a newer version than version 2 of the ordinary GNU General Public License has appeared, then you can specify that version instead if you wish.) Do not make any other change in these notices.

Once this change is made in a given copy, it is irreversible for that copy, so the ordinary GNU General Public License applies to all subsequent copies and derivative works made from that copy.

This option is useful when you wish to copy part of the code of the Library into a program that is not a library.

4. You may copy and distribute the Library (or a portion or derivative of it, under Section 2) in object code or executable form under the terms of Sections 1 and 2 above provided that you accompany it with the complete corresponding machine-readable source code, which must be distributed under the terms of Sections 1 and 2 above on a medium customarily used for software interchange.

If distribution of object code is made by offering access to copy from a designated place, then offering equivalent access to copy the source code from the same place satisfies the requirement to distribute the source code, even though third parties are not compelled to copy the source along with the object code.

5. A program that contains no derivative of any portion of the Library, but is designed to work with the Library by being compiled or linked with it, is

called a "work that uses the Library". Such a work, in isolation, is not a derivative work of the Library, and therefore falls outside the scope of this License.

However, linking a "work that uses the Library" with the Library creates an executable that is a derivative of the Library (because it contains portions of the Library), rather than a "work that uses the library". The executable is therefore covered by this License.

Section 6 states terms for distribution of such executables.

When a "work that uses the Library" uses material from a header file that is part of the Library, the object code for the work may be a derivative work of the Library even though the source code is not. Whether this is true is especially significant if the work can be linked without the Library, or if the work is itself a library. The threshold for this to be true is not precisely defined by law.

If such an object file uses only numerical parameters, data structure layouts and accessors, and small macros and small inline functions (ten lines or less in length), then the use of the object file is unrestricted, regardless of whether it is legally a derivative work. (Executables containing this object code plus portions of the Library will still fall under Section 6.)

Otherwise, if the work is a derivative of the Library, you may distribute the object code for the work under the terms of Section 6. Any executables containing that work also fall under Section 6, whether or not they are linked directly with the Library itself.

6. As an exception to the Sections above, you may also combine or link a "work that uses the Library" with the Library to produce a work containing portions of the Library, and distribute that work under terms of your choice, provided that the terms permit modification of the work for the customer's own use and reverse engineering for debugging such modifications.

You must give prominent notice with each copy of the work that the Library is used in it and that the Library and its use are covered by this License. You must supply a copy of this License. If the work during execution displays copyright notices, you must include the copyright notice for the Library among them, as well as a reference directing the user to the copy of this License. Also, you must do one of these things:

a) Accompany the work with the complete corresponding machine-readable source code for the Library including whatever changes were used in the work (which must be distributed under Sections 1 and 2 above); and, if the work is an executable linked with the Library, with the complete machine-readable "work that uses the Library", as object code and/or source code, so that the user can modify the

Library and then relink to produce a modified executable containing the modified Library. (It is understood that the user who changes the contents of definitions files in the Library will not necessarily be able to recompile the application to use the modified definitions.)

b) Use a suitable shared library mechanism for linking with the Library. A suitable mechanism is one that (1) uses at run time a copy of the library already present on the user's computer system rather than copying library functions into the executable, and (2) will operate properly with a modified version of the library, if the user installs one, as long as the modified version is interface-compatible with the version that the work was made with.

c) Accompany the work with a written offer, valid for at least three years, to give the same user the materials specified in Subsection 6a, above, for a charge no more than the cost of performing this distribution.

d) If distribution of the work is made by offering access to copy from a designated place, offer equivalent access to copy the above specified materials from the same place.

e) Verify that the user has already received a copy of these materials or that you have already sent this user a copy.

For an executable, the required form of the "work that uses the Library" must include any data and utility programs needed for reproducing the executable from it. However, as a special exception, the materials to be distributed need not include anything that is normally distributed (in either source or binary form) with the major components (compiler, kernel, and so on) of the operating system on which the executable runs, unless that component itself accompanies the executable.

It may happen that this requirement contradicts the license restrictions of other proprietary libraries that do not normally accompany the operating system. Such a contradiction means you cannot use both them and the Library together in an executable that you

7. You may place library facilities that are a work based on the Library side-by-side in a single library together with other library facilities not covered by this License, and distribute such a combined library, provided that the separate distribution of the work based on the Library and of the other library facilities is otherwise permitted, and provided that you do these two things:

a) Accompany the combined library with a copy of the same work based on the Library, uncombined with any other library facilities. This must be distributed under the terms of the Sections above.

b) Give prominent notice with the combined

library of the fact that part of it is a work based on the Library, and explaining where to find the accompanying uncombined form of the same work.

8. You may not copy, modify, sublicense, link with, or distribute the Library except as expressly provided under this License. Any attempt otherwise to copy, modify, sublicense, link with, or distribute the Library is void, and will automatically terminate your rights under this License. However, parties who have received copies, or rights, from you under this License will not have their licenses terminated so long as such parties remain in full compliance.

9. You are not required to accept this License, since you have not signed it. However, nothing else grants you permission to modify or distribute the Library or its derivative works. These actions are prohibited by law if you do not accept this License. Therefore, by modifying or distributing the Library (or any work based on the Library), you indicate your acceptance of this License to do so, and all its terms and conditions for copying, distributing or modifying the Library or works based on it.

10. Each time you redistribute the Library (or any work based on the Library), the recipient automatically receives a license from the original licensor to copy, distribute, link with or modify the Library subject to these terms and conditions. You may not impose any further restrictions on the recipients' exercise of the rights granted herein. You are not responsible for enforcing compliance by third parties with this License.

11. If, as a consequence of a court judgment or allegation of patent infringement or for any other reason (not limited to patent issues), conditions are imposed on you (whether by court order, agreement or otherwise) that contradict the conditions of this License, they do not excuse you from the conditions of this License. If you cannot distribute so as to satisfy simultaneously your obligations under this License and any other pertinent obligations, then as a consequence you may not distribute the Library at all. For example, if a patent license would not permit royalty-free redistribution of the Library by all those who receive copies directly or indirectly through you, then the only way you could satisfy both it and this License would be to refrain entirely from distribution of the Library.

If any portion of this section is held invalid or unenforceable under any particular circumstance, the balance of the section is intended to apply, and the section as a whole is intended to apply in other circumstances.

It is not the purpose of this section to induce you to infringe any patents or other property right claims or to contest validity of any such claims; this section has the sole purpose of protecting the integrity of the

free software distribution system which is implemented by public license practices. Many people have made generous contributions to the wide range of software distributed through that system in reliance on consistent application of that system; it is up to the author/donor to decide if he or she is willing to distribute software through any other system and a licensee cannot impose that choice.

This section is intended to make thoroughly clear what is believed to be a consequence of the rest of this License.

12. If the distribution and/or use of the Library is restricted in certain countries either by patents or by copyrighted interfaces, the original copyright holder who places the Library under this License may add an explicit geographical distribution limitation excluding those countries, so that distribution is permitted only in or among countries not thus excluded. In such case, this License incorporates the limitation as if written in the body of this License.

13. The Free Software Foundation may publish revised and/or new versions of the Lesser General Public License from time to time. Such new versions will be similar in spirit to the present version, but may differ in detail to address new problems or concerns.

Each version is given a distinguishing version number. If the Library specifies a version number of this License which applies to it and "any later version", you have the option of following the terms and conditions either of that version or of any later version published by the Free Software Foundation. If the Library does not specify a license version number, you may choose any version ever published by the Free Software Foundation.

14. If you wish to incorporate parts of the Library into other free programs whose distribution conditions are incompatible with these, write to the author to ask for permission. For software which is copyrighted by the Free Software Foundation, write to the Free Software Foundation; we sometimes make exceptions for this. Our decision will be guided by the two goals of preserving the free status of all derivatives of our free software and of promoting the sharing and reuse of software generally.

NO WARRANTY

15. BECAUSE THE LIBRARY IS LICENSED FREE OF CHARGE, THERE IS NO

WARRANTY FOR THE LIBRARY, TO THE EXTENT PERMITTED BY APPLICABLE LAW.

EXCEPT WHEN OTHERWISE STATED IN WRITING THE COPYRIGHT HOLDERS AND/OR

OTHER PARTIES PROVIDE THE LIBRARY "AS IS"

WITHOUT WARRANTY OF ANY

KIND, EITHER EXPRESSED OR IMPLIED, INCLUDING, BUT NOT LIMITED TO, THE

IMPLIED WARRANTIES OF MERCHANTABILITY AND FITNESS FOR A PARTICULAR

PURPOSE. THE ENTIRE RISK AS TO THE QUALITY AND PERFORMANCE OF THE

LIBRARY IS WITH YOU. SHOULD THE LIBRARY PROVE DEFECTIVE, YOU ASSUME

THE COST OF ALL NECESSARY SERVICING, REPAIR OR CORRECTION.

16. IN NO EVENT UNLESS REQUIRED BY APPLICABLE LAW OR AGREED TO IN

WRITING WILL ANY COPYRIGHT HOLDER, OR ANY OTHER PARTY WHO MAY MODIFY

AND/OR REDISTRIBUTE THE LIBRARY AS PERMITTED ABOVE, BE LIABLE TO YOU

FOR DAMAGES, INCLUDING ANY GENERAL, SPECIAL, INCIDENTAL OR

CONSEQUENTIAL DAMAGES ARISING OUT OF THE USE OR INABILITY TO USE THE

LIBRARY (INCLUDING BUT NOT LIMITED TO LOSS OF DATA OR DATA BEING

RENDERED INACCURATE OR LOSSES SUSTAINED BY YOU OR THIRD PARTIES OR A

FAILURE OF THE LIBRARY TO OPERATE WITH ANY OTHER SOFTWARE), EVEN IF

SUCH HOLDER OR OTHER PARTY HAS BEEN ADVISED OF THE POSSIBILITY OF SUCH

END OF TERMS AND
CONDITIONS

Other

name License

Chromium URL: <http://www.chromium.org>

Copyright (c) 2013 The Chromium Authors. All rights reserved.

Redistribution and use in source and binary forms, with or without modification, are permitted provided that the following conditions are met:

* Redistributions of source code must retain the above copyright

notice, this list of conditions and the following disclaimer.

* Redistributions in binary form must reproduce the above

copyright notice, this list of conditions and the following disclaimer

in the documentation and/or other materials provided with the

* Neither the name of Google Inc. nor the names of its

contributors may be used to endorse or promote products derived from

this software without specific prior written permission.

THIS SOFTWARE IS PROVIDED BY THE COPYRIGHT HOLDERS AND CONTRIBUTORS

"AS IS" AND ANY EXPRESS OR IMPLIED WARRANTIES, INCLUDING, BUT NOT

LIMITED TO, THE IMPLIED WARRANTIES OF MERCHANTABILITY AND FITNESS FOR

A PARTICULAR PURPOSE ARE DISCLAIMED. IN NO EVENT SHALL THE COPYRIGHT

OWNER OR CONTRIBUTORS BE LIABLE FOR ANY DIRECT, INDIRECT, INCIDENTAL,

SPECIAL, EXEMPLARY, OR CONSEQUENTIAL DAMAGES (INCLUDING, BUT NOT

LIMITED TO, PROCUREMENT OF SUBSTITUTE GOODS OR SERVICES; LOSS OF USE,

DATA, OR PROFITS; OR BUSINESS INTERRUPTION) HOWEVER CAUSED AND ON ANY

THEORY OF LIABILITY, WHETHER IN CONTRACT, STRICT LIABILITY, OR TORT

(INCLUDING NEGLIGENCE OR OTHERWISE) ARISING IN ANY WAY OUT OF THE USE

OF THIS SOFTWARE, EVEN IF ADVISED OF THE POSSIBILITY OF SUCH DAMAGE.

--

The following files are distributed under the MPL 1.1/GPL 2.0/LGPL 2.1 tri-license:

chromium-nss.h

chromium-blapi.h

chromium-blapit.h

chromium-sha256.h

chromium-prtypes.h

The following files contain portions distributed under the MPL 1.1/GPL 2.0/LGPL 2.1 tri-license:

registry_controlled_domains/registry_controlled_domain.cc

registry_controlled_domains/registry_controlled_domain.h

The following files are distributed under the MPL 2.0 license:

Fontconfig

URL: <http://www.fontconfig.org>

Copyright © 2000,2001,2002,2003,2004,2006,2007 Keith Packard

Copyright © 2005 Patrick Lam

Copyright © 2009 Roozbeh Pournader

Copyright © 2008,2009 Red Hat, Inc.

Copyright © 2008 Danilo Šegan

Permission to use, copy, modify, distribute, and sell this software and its

documentation for any purpose is hereby granted without fee, provided that

the above copyright notice appear in all copies and that both that

copyright notice and this permission notice appear in supporting

documentation, and that the name of the author(s) not be used in

advertising or publicity pertaining to distribution of the software without

specific, written prior permission. The authors make no

representations about the suitability of this software for any purpose. It

is provided "as is" without express or implied warranty.

THE AUTHOR(S) DISCLAIMS ALL WARRANTIES WITH REGARD TO THIS SOFTWARE,

INCLUDING ALL IMPLIED WARRANTIES OF MERCHANTABILITY AND FITNESS, IN NO

EVENT SHALL THE AUTHOR(S) BE LIABLE FOR ANY SPECIAL, INDIRECT OR

CONSEQUENTIAL DAMAGES OR ANY DAMAGES WHATSOEVER RESULTING FROM LOSS OF USE,

DATA OR PROFITS, WHETHER IN AN ACTION OF CONTRACT, NEGLIGENCE OR OTHER

TORTIOUS ACTION, ARISING OUT OF OR IN CONNECTION WITH THE USE OR

PERFORMANCE OF THIS SOFTWARE.

Arphic fonts

URL:

<http://www.freedesktop.org/wiki/Software/CJKUnifonts/Download>

ARPHIC PUBLIC LICENSE

Copyright (C) 1999 Arphic Technology Co., Ltd.

All rights reserved except as specified below.

Everyone is permitted to copy and distribute verbatim copies of this license document, but changing it is forbidden.

Preamble

The licenses for most software are designed to take away your freedom to share and change it. By contrast, the ARPHIC PUBLIC LICENSE specifically permits and encourages you to use this software, provided that you give the recipients all the rights that we gave you and make sure they can get the modifications of this software.

Legal Terms

Throughout this License, "Font" means the TrueType fonts "AR PL Mingti2L Big5", "AR PL KaitiM Big5" (BIG-5 character set) and "AR PL SungtiL GB", "AR PL KaitiM GB" (GB character set) which are originally distributed by Arphic, and the derivatives of those fonts created through any modification including modifying glyph, reordering glyph, converting format, changing font name, or adding/deleting some characters in/from glyph table.

"PL" means "Public License".

"Copyright Holder" means whoever is named in the copyright or copyrights for the Font.

"You" means the licensee, or person copying, redistributing or modifying the Font.

"Freely Available" means that you have the freedom to copy or modify the Font as well as redistribute copies of the Font under the same conditions you received, not price. If you wish, you can charge for this service.

You may copy and distribute verbatim copies of this Font in any medium, without restriction, provided that you retain this license file (ARPHICPL.TXT) unaltered in all copies.

You may otherwise modify your copy of this Font in any way, including modifying glyph, reordering glyph, converting format, changing font name, or adding/deleting some characters in/from glyph table,

and copy and distribute such modifications under the terms of Section 1 above, provided that the following conditions are met:

a) You must insert a prominent notice in each modified file stating how and when you changed that file.

b) You must make such modifications Freely Available as a whole to all third parties under the terms of this License, such as by offering access to copy the modifications from a designated place, or distributing the modifications on a medium customarily used for software interchange.

c) If the modified fonts normally reads commands interactively when run, you must cause it, when started running for such interactive use in the most ordinary way, to print or display an announcement including an appropriate copyright notice and a notice that there is no warranty (or else, saying that you provide a warranty) and that users may redistribute the Font under these conditions, and telling the user how to view a copy of this License.

These requirements apply to the modified work as a whole. If identifiable sections of that work are not derived from the Font, and can be reasonably considered independent and separate works in themselves, then this License and its terms, do not apply to those sections when you distribute them as separate works. Therefore, mere aggregation of another work not based on the Font with the Font on a volume of a storage or distribution medium does not bring the other work under the scope of this License.

You may not copy, modify, sublicense, or distribute the Font except as expressly provided under this License. Any attempt otherwise to copy, modify, sublicense or distribute the Font will automatically retroactively void your rights under this License. However, parties who have received copies or rights from you under this License will keep their licenses valid so long as such parties remain in full compliance.

You are not required to accept this License, since you have not signed it. However, nothing else grants you permission to copy, modify, sublicense or distribute the Font. These actions are prohibited by law if you do not accept this License. Therefore, by copying, modifying, sublicensing or distributing the Font, you indicate your acceptance of this License and all its terms and conditions.

Each time you redistribute the Font, the recipient automatically receives a license from the original licensor to copy, distribute or modify the Font subject to these terms and conditions. You may not impose any further restrictions on the recipients' exercise of the rights granted herein. You are not responsible for enforcing compliance by third parties to this License.

If, as a consequence of a court judgment or allegation of patent infringement or for any other reason (not limited to patent issues), conditions are imposed on you (whether by court order, agreement or otherwise) that contradict the conditions of this License, they do not excuse you from the conditions of this License. If you cannot distribute so as to satisfy simultaneously your obligations under this License and any other pertinent obligations, then as a consequence you may not distribute the Font at all. For example, if a patent license would not permit royalty-free redistribution of the Font by all those who receive copies directly or indirectly through you, then the only way you could satisfy both it and this License would be to refrain entirely from distribution of the Font.

If any portion of this section is held invalid or unenforceable under any particular circumstance, the balance of the section is intended to apply and the section as a whole is intended to apply in other circumstances.

BECAUSE THE FONT IS LICENSED FREE OF CHARGE, THERE IS NO WARRANTY FOR THE FONT, TO THE EXTENT PERMITTED BY APPLICABLE LAW. EXCEPT WHEN OTHERWISE STATED IN WRITING THE COPYRIGHT HOLDERS OR OTHER PARTIES PROVIDE THE FONT "AS IS" WITHOUT WARRANTY OF ANY KIND, EITHER EXPRESSED OR IMPLIED, INCLUDING BUT NOT LIMITED TO THE IMPLIED WARRANTIES OF MERCHANTABILITY AND FITNESS FOR A PARTICULAR PURPOSE. THE ENTIRE RISK AS TO THE QUALITY AND PERFORMANCE OF THE FONT IS WITH YOU. SHOULD THE FONT PROVE DEFECTIVE, YOU ASSUME THE COST OF ALL NECESSARY SERVICING, REPAIR OR CORRECTION.

UNLESS REQUIRED BY APPLICABLE LAW OR AGREED TO IN WRITING, IN NO EVENT WILL ANY COPYRIGHTT HOLDERS, OR OTHER PARTIES WHO MAY COPY, MODIFY OR REDISTRIBUTE THE FONT AS PERMITTED ABOVE, BE LIABLE TO YOU FOR ANY DIRECT, INDIRECT, CONSEQUENTIAL, INCIDENTAL, SPECIAL OR EXEMPLARY DAMAGES ARISING OUT OF THE USE OR INABILITY TO USE THE FONT (INCLUDING BUT NOT LIMITED TO PROCUREMENT OF SUBSTITUTE GOODS OR SERVICES; LOSS OF USE, DATA OR PROFITS; OR BUSINESS INTERRUPTION), EVEN IF SUCH HOLDERS OR OTHER PARTIES HAVE BEEN ADVISED OF THE POSSIBILITY OF SUCH DAMAGES.

Bitstream Vera fonts

URL:
http://www.gnome.org/fonts/#Final_Bitstream_Vera_Fonts

Bitstream Vera Fonts Copyright

The fonts have a generous copyright, allowing

derivative works (as long as "Bitstream" or "Vera" are not in the names), and full redistribution (so long as they are not *sold* by themselves). They can be bundled, redistributed and sold with any software.

The fonts are distributed under the following copyright:

Copyright

=====

Copyright (c) 2003 by Bitstream, Inc. All Rights Reserved. Bitstream

Vera is a trademark of Bitstream, Inc.

Permission is hereby granted, free of charge, to any person obtaining

a copy of the fonts accompanying this license ("Fonts") and associated

documentation files (the "Font Software"), to reproduce and distribute

the Font Software, including without limitation the rights to use,

copy, merge, publish, distribute, and/or sell copies of the Font

Software, and to permit persons to whom the Font Software is furnished

to do so, subject to the following conditions:

The above copyright and trademark notices and this permission notice

shall be included in all copies of one or more of the Font Software

The Font Software may be modified, altered, or added to, and in

particular the designs of glyphs or characters in the Fonts may be

modified and additional glyphs or characters may be added to the

Fonts, only if the fonts are renamed to names not containing either

the words "Bitstream" or the word "Vera".

This License becomes null and void to the extent applicable to Fonts

or Font Software that has been modified and is distributed under the

"Bitstream Vera" names.

The Font Software may be sold as part of a larger software package but

no copy of one or more of the Font Software typefaces may be sold by itself.

THE FONT SOFTWARE IS PROVIDED "AS IS",

WITHOUT WARRANTY OF ANY KIND,
EXPRESS OR IMPLIED, INCLUDING BUT NOT
LIMITED TO ANY WARRANTIES OF
MERCHANTABILITY, FITNESS FOR A PARTICULAR
PURPOSE AND NONINFRINGEMENT
OF COPYRIGHT, PATENT, TRADEMARK, OR OTHER
RIGHT. IN NO EVENT SHALL
BITSTREAM OR THE GNOME FOUNDATION BE
LIABLE FOR ANY CLAIM, DAMAGES OR
OTHER LIABILITY, INCLUDING ANY GENERAL,
SPECIAL, INDIRECT, INCIDENTAL,
OR CONSEQUENTIAL DAMAGES, WHETHER IN AN
ACTION OF CONTRACT, TORT OR
OTHERWISE, ARISING FROM, OUT OF THE USE OR
INABILITY TO USE THE FONT
SOFTWARE OR FROM OTHER DEALINGS IN THE
FONT SOFTWARE.

Except as contained in this notice, the names of
Gnome, the Gnome
Foundation, and Bitstream Inc., shall not be used in
advertising or
otherwise to promote the sale, use or other dealings
in this Font
Software without prior written authorization from the
Gnome Foundation
or Bitstream Inc., respectively. For further information,
contact:
fonts at gnome dot org.

Copyright FAQ

=====

1. I don't understand the resale restriction... What gives?

Bitstream is giving away these fonts, but wishes to ensure its competitors can't just drop the fonts as is into a font sale system and sell them as is. It seems fair that if Bitstream can't make money from the Bitstream Vera fonts, their competitors should not be able to do so either. You can sell the fonts as part of any software package, however.

2. I want to package these fonts separately for distribution and

sale as part of a larger software package or system. Can I do so?

Yes. A RPM or Debian package is a "larger software package" to begin

with, and you aren't selling them independently by themselves.

See 1. above.

3. Are derivative works allowed?

Yes!

4. Can I change or add to the font(s)?

Yes, but you must change the name(s) of the font(s).

5. Under what terms are derivative works allowed?

You must change the name(s) of the fonts. This is to ensure the

quality of the fonts, both to protect Bitstream and Gnome. We want to

ensure that if an application has opened a font specifically of these

names, it gets what it expects (though of course, using fontconfig,

substitutions could still could have occurred during font

opening). You must include the Bitstream copyright. Additional

copyrights can be added, as per copyright law. Happy Font Hacking!

6. If I have improvements for Bitstream Vera, is it possible they might get

adopted in future versions?

Yes. The contract between the Gnome Foundation and Bitstream has

provisions for working with Bitstream to ensure quality additions to

the Bitstream Vera font family. Please contact us if you have such

additions. Note, that in general, we will want such additions for the

entire family, not just a single font, and that you'll have to keep

both Gnome and Jim Lyles, Vera's designer, happy! To make sense to add

glyphs to the font, they must be stylistically in

keeping with Vera's

design. Vera cannot become a "ransom note" font. Jim Lyles will be

providing a document describing the design elements used in Vera, as a

guide and aid for people interested in contributing to Vera.

7. I want to sell a software package that uses these fonts: Can I do so?

Sure. Bundle the fonts with your software and sell your software

with the fonts. That is the intent of the copyright.

8. If applications have built the names "Bitstream Vera" into them,

can I override this somehow to use fonts of my choosing?

This depends on exact details of the software. Most open source

systems and software (e.g., Gnome, KDE, etc.) are now converting to

use fontconfig (see www.fontconfig.org) to handle font configuration,

selection and substitution; it has provisions for overriding font

names and substituting alternatives. An example is provided by the

supplied local.conf file, which chooses the family Bitstream Vera for

"sans", "serif" and "monospace". Other software (e.g., the XFree86

core server) has other mechanisms for font substitution.

Open Sans fonts

URL:
<http://www.google.com/fonts/specimen/Open+Sans>

License for Open Sans Font Family

Apache License

Version 2.0,
January 2004

<http://www.apache.org/licenses/>

TERMS AND CONDITIONS FOR USE, REPRODUCTION, AND DISTRIBUTION

1. Definitions.

"License" shall mean the terms and conditions for use, reproduction,

and distribution as defined by Sections 1 through 9 of this document.

"Licensor" shall mean the copyright owner or entity authorized by

the copyright owner that is granting the License.

"Legal Entity" shall mean the union of the acting entity and all

other entities that control, are controlled by, or are under common

control with that entity. For the purposes of this definition,

"control" means (i) the power, direct or indirect, to cause the

direction or management of such entity, whether by contract or

otherwise, or (ii) ownership of fifty percent (50%) or more of the

outstanding shares, or (iii) beneficial ownership of such entity.

"You" (or "Your") shall mean an individual or Legal Entity

exercising permissions granted by this License.

"Source" form shall mean the preferred form for making modifications,

including but not limited to software source code, documentation

source, and configuration files.

"Object" form shall mean any form resulting from mechanical

transformation or translation of a Source form, including but

not limited to compiled object code, generated documentation,

and conversions to other media types.

"Work" shall mean the work of authorship, whether in Source or

Object form, made available under the License, as indicated by a

copyright notice that is included in or attached to the work

(an example is provided in the Appendix below).

"Derivative Works" shall mean any work, whether in Source or Object

form, that is based on (or derived from) the Work and for which the

editorial revisions, annotations, elaborations, or other modifications

represent, as a whole, an original work of authorship. For the purposes

of this License, Derivative Works shall not include works that remain

separable from, or merely link (or bind by name) to the interfaces of,

the Work and Derivative Works thereof.

"Contribution" shall mean any work of authorship, including

the original version of the Work and any modifications or additions

to that Work or Derivative Works thereof, that is intentionally

submitted to Licensor for inclusion in the Work by the copyright owner

or by an individual or Legal Entity authorized to submit on behalf of

the copyright owner. For the purposes of this definition, "submitted"

means any form of electronic, verbal, or written communication sent

to the Licensor or its representatives, including but not limited to

communication on electronic mailing lists, source code control systems,

and issue tracking systems that are managed by, or on behalf of, the

Licensor for the purpose of discussing and improving the Work, but

excluding communication that is conspicuously marked or otherwise

designated in writing by the copyright owner as "Not a Contribution."

"Contributor" shall mean Licensor and any individual or Legal Entity

on behalf of whom a Contribution has been received by Licensor and

subsequently incorporated within the Work.

2. Grant of Copyright License. Subject to the terms

and conditions of

this License, each Contributor hereby grants to You a perpetual,

worldwide, non-exclusive, no-charge, royalty-free, irrevocable

copyright license to reproduce, prepare Derivative Works of,

publicly display, publicly perform, sublicense, and distribute the

Work and such Derivative Works in Source or Object form.

3. Grant of Patent License. Subject to the terms and conditions of

this License, each Contributor hereby grants to You a perpetual,

worldwide, non-exclusive, no-charge, royalty-free, irrevocable

(except as stated in this section) patent license to make, have made,

use, offer to sell, sell, import, and otherwise transfer the Work,

where such license applies only to those patent claims licensable

by such Contributor that are necessarily infringed by their

Contribution(s) alone or by combination of their Contribution(s)

with the Work to which such Contribution(s) was submitted. If You

institute patent litigation against any entity (including a

cross-claim or counterclaim in a lawsuit) alleging that the Work

or a Contribution incorporated within the Work constitutes direct

or contributory patent infringement, then any patent licenses

granted to You under this License for that Work shall terminate

as of the date such litigation is filed.

4. Redistribution. You may reproduce and distribute copies of the

Work or Derivative Works thereof in any medium, with or without

modifications, and in Source or Object form, provided that You

meet the following conditions:

- (a) You must give any other recipients of the Work or Derivative Works a copy of this License; and
- (b) You must cause any modified files to carry prominent notices stating that You changed the files; and
- (c) You must retain, in the Source form of any Derivative Works that You distribute, all copyright, patent, trademark, and attribution notices from the Source form of the Work, excluding those notices that do not pertain to any part of the Derivative Works; and
- (d) If the Work includes a "NOTICE" text file as part of its distribution, then any Derivative Works that You distribute must include a readable copy of the attribution notices contained within such NOTICE file, excluding those notices that do not pertain to any part of the Derivative Works, in at least one of the following places: within a NOTICE text file distributed as part of the Derivative Works; within the Source form or documentation, if provided along with the Derivative Works; or, within a display generated by the Derivative Works, if and wherever such third-party notices normally appear. The contents of the NOTICE file are for informational purposes only and do not modify the License. You may add Your own attribution notices within Derivative Works that You distribute, alongside or as an addendum to the NOTICE text from the Work, provided that such additional attribution notices cannot be construed

as modifying the License.

You may add Your own copyright statement to Your modifications and may provide additional or different license terms and conditions for use, reproduction, or distribution of Your modifications, or for any such Derivative Works as a whole, provided Your use, reproduction, and distribution of the Work otherwise complies with the conditions stated in this License.

5. Submission of Contributions. Unless You explicitly state otherwise, any Contribution intentionally submitted for inclusion in the Work by You to the Licensor shall be under the terms and conditions of this License, without any additional terms or conditions. Notwithstanding the above, nothing herein shall supersede or modify the terms of any separate license agreement you may have executed with Licensor regarding such Contributions.

6. Trademarks. This License does not grant permission to use the trade names, trademarks, service marks, or product names of the Licensor, except as required for reasonable and customary use in describing the origin of the Work and reproducing the content of the NOTICE file.

7. Disclaimer of Warranty. Unless required by applicable law or agreed to in writing, Licensor provides the Work (and each Contributor provides its Contributions) on an "AS IS" BASIS, WITHOUT WARRANTIES OR CONDITIONS OF ANY KIND, either express or implied, including, without limitation, any warranties or conditions of TITLE, NON-INFRINGEMENT,

MERCHANTABILITY, or FITNESS FOR A

PARTICULAR PURPOSE. You are solely responsible for determining the

appropriateness of using or redistributing the Work and assume any

risks associated with Your exercise of permissions under this License.

8. Limitation of Liability. In no event and under no legal theory,

whether in tort (including negligence), contract, or otherwise,

unless required by applicable law (such as deliberate and grossly

negligent acts) or agreed to in writing, shall any Contributor be

liable to You for damages, including any direct, indirect, special,

incidental, or consequential damages of any character arising as a

result of this License or out of the use or inability to use the

Work (including but not limited to damages for loss of goodwill,

work stoppage, computer failure or malfunction, or any and all

other commercial damages or losses), even if such Contributor

has been advised of the possibility of such damages.

9. Accepting Warranty or Additional Liability. While redistributing

the Work or Derivative Works thereof, You may choose to offer,

and charge a fee for, acceptance of support, warranty, indemnity,

or other liability obligations and/or rights consistent with this

License. However, in accepting such obligations, You may act only

on Your own behalf and on Your sole responsibility, not on behalf

of any other Contributor, and only if You agree to indemnify,

defend, and hold each Contributor harmless for any liability

incurred by, or claims asserted against, such

Contributor by reason

of your accepting any such warranty or additional liability.

END OF TERMS AND CONDITIONS

APPENDIX: How to apply the Apache License to your work.

To apply the Apache License to your work, attach the following

boilerplate notice, with the fields enclosed by brackets "[]"

replaced with your own identifying information. (Don't include

the brackets!) The text should be enclosed in the appropriate

comment syntax for the file format. We also recommend that a

file or class name and description of purpose be included on the

same "printed page" as the copyright notice for easier

identification within third-party archives.

Copyright [yyyy] [name of copyright owner]

Licensed under the Apache License, Version 2.0 (the "License");

you may not use this file except in compliance with the License.

You may obtain a copy of the License at

<http://www.apache.org/licenses/LICENSE-2.0>

Unless required by applicable law or agreed to in writing, software

distributed under the License is distributed on an "AS IS" BASIS,

WITHOUT WARRANTIES OR CONDITIONS OF ANY KIND, either express or implied.

See the License for the specific language governing permissions and

limitations under the License.

VL Gothic fonts

URL: <http://dicey.org/vlgothic/index.html>

License for VL Gothic Font Family

This font includes glyphs derived from M+ FONTS which is created by

M+ FONTS PROJECT. License for M+ FONTS part is described in M+ FONTS

PROJECT's license. See attached 'LICENSE_E.mplus'.

This font also includes glyphs derived from Sazanami Gothic font which

is created by Electronic Font Open Laboratory (/efont/). License for

Sazanami Gothic part is described in it's license. See attached

'README.sazanami' for original Sazanami Gothic font license.

This font also includes original glyphs which is created by Daisuke

SUZUKI and Project Vine based on M+ FONTS. License for VL Gothic

original glyphs is same as M+ FONTS PROJECT's license.

There is no limitation and the below description is not applied

as for in order not to reuse as font (ex: font is embedded to documents).

Copyright (c) 1990-2003 Wada Laboratory, the University of Tokyo.

Copyright (c) 2003-2004 Electronic Font Open Laboratory (/efont/).

Copyright (C) 2003-2009 M+ FONTS PROJECT

Copyright (C) 2006-2009 Daisuke SUZUKI <daisuke@vinelinux.org>.

Copyright (C) 2006-2009 Project Vine <Vine@vinelinux.org>.

All rights reserved.

Redistribution and use in source and binary forms, with or without

modification, are permitted provided that the following conditions

are met:

 this list of conditions and the following disclaimer.

 this list of conditions and the following disclaimer in the documentation

and/or other materials provided with the distribution.

 the names of its contributors may be used to endorse or promote products

 derived from this software without specific prior written permission.

THIS SOFTWARE IS PROVIDED BY WADA LABORATORY, THE UNIVERSITY OF TOKYO AND

CONTRIBUTORS "AS IS" AND ANY EXPRESS OR IMPLIED WARRANTIES, INCLUDING, BUT

NOT LIMITED TO, THE IMPLIED WARRANTIES OF MERCHANTABILITY AND FITNESS FOR A

PARTICULAR PURPOSE ARE DISCLAIMED. IN NO EVENT SHALL THE LABORATORY OR

CONTRIBUTORS BE LIABLE FOR ANY DIRECT, INDIRECT, INCIDENTAL, SPECIAL,

EXEMPLARY, OR CONSEQUENTIAL DAMAGES (INCLUDING, BUT NOT LIMITED TO,

PROCUREMENT OF SUBSTITUTE GOODS OR SERVICES; LOSS OF USE, DATA, OR PROFITS;

OR BUSINESS INTERRUPTION) HOWEVER CAUSED AND ON ANY THEORY OF LIABILITY,

WHETHER IN CONTRACT, STRICT LIABILITY, OR TORT (INCLUDING NEGLIGENCE OR

OTHERWISE) ARISING IN ANY WAY OUT OF THE USE OF THIS SOFTWARE, EVEN IF

ADVISED OF THE POSSIBILITY OF SUCH DAMAGE.

Nanum fonts

URL: <http://hangeul.naver.com/>

Copyright (c) 2010, NAVER Corporation (<http://www.nhncorp.com>),

with Reserved Font Name Nanum, Naver Nanum, NanumGothic, Naver NanumGothic, NanumMyeongjo, Naver NanumMyeongjo, NanumBrush, Naver NanumBrush, NanumPen, Naver NanumPen, Naver NanumGothicEco, NanumGothicEco, Naver NanumMyeongjoEco, NanumMyeongjoEco, Naver NanumGothicLight, NanumGothicLight, NanumBarunGothic, Naver NanumBarunGothic,

This Font Software is licensed under the SIL Open Font License, Version 1.1.

This license is copied below, and is also available with a FAQ at: <http://scripts.sil.org/OFL>

This Font Software is licensed under the SIL Open Font License, Version 1.1.

This license is copied below, and is also available with

a FAQ at:

<http://scripts.sil.org/OFL>

SIL OPEN FONT LICENSE Version 1.1 - 26 February
2007

PREAMBLE

The goals of the Open Font License (OFL) are to stimulate worldwide development of collaborative font projects, to support the font creation efforts of academic and linguistic communities, and to provide a free and open framework in which fonts may be shared and improved in partnership with others.

The OFL allows the licensed fonts to be used, studied, modified and redistributed freely as long as they are not sold by themselves. The fonts, including any derivative works, can be bundled, embedded, redistributed and/or sold with any software provided that any reserved names are not used by derivative works. The fonts and derivatives, however, cannot be released under any other type of license. The requirement for fonts to remain under this license does not apply to any document created using the fonts or their derivatives.

DEFINITIONS

"Font Software" refers to the set of files released by the Copyright Holder(s) under this license and clearly marked as such. This may include source files, build scripts and documentation.

"Reserved Font Name" refers to any names specified as such after the copyright statement(s).

"Original Version" refers to the collection of Font Software components as distributed by the Copyright Holder(s).

"Modified Version" refers to any derivative made by adding to, deleting, or substituting -- in part or in whole -- any of the components of the Original Version, by changing formats or by porting the Font Software to a new environment.

"Author" refers to any designer, engineer, programmer, technical writer or other person who contributed to the Font Software.

PERMISSION & CONDITIONS

Permission is hereby granted, free of charge, to any person obtaining

a copy of the Font Software, to use, study, copy, merge, embed, modify,

redistribute, and sell modified and unmodified copies of the Font

Software, subject to the following conditions:

1) Neither the Font Software nor any of its individual components,
in Original or Modified Versions, may be sold by itself.

2) Original or Modified Versions of the Font Software may be bundled,

redistributed and/or sold with any software, provided that each copy

contains the above copyright notice and this license. These can be

included either as stand-alone text files, human-readable headers or

in the appropriate machine-readable metadata fields within text or

binary files as long as those fields can be easily viewed by the user.

3) No Modified Version of the Font Software may use the Reserved Font

Name(s) unless explicit written permission is granted by the corresponding

Copyright Holder. This restriction only applies to the primary font name as

presented to the users.

4) The name(s) of the Copyright Holder(s) or the Author(s) of the Font

Software shall not be used to promote, endorse or advertise any

Modified Version, except to acknowledge the contribution(s) of the

Copyright Holder(s) and the Author(s) or with their explicit written

5) The Font Software, modified or unmodified, in part or in whole,

must be distributed entirely under this license, and must not be

distributed under any other license. The requirement for fonts to

remain under this license does not apply to any document created

using the Font Software.

TERMINATION

This license becomes null and void if any of the above conditions are not met.

DISCLAIMER

THE FONT SOFTWARE IS PROVIDED "AS IS", WITHOUT WARRANTY OF ANY KIND, EXPRESS OR IMPLIED, INCLUDING BUT NOT LIMITED TO ANY WARRANTIES OF MERCHANTABILITY, FITNESS FOR A PARTICULAR PURPOSE AND NONINFRINGEMENT OF COPYRIGHT, PATENT, TRADEMARK, OR OTHER RIGHT. IN NO EVENT SHALL THE COPYRIGHT HOLDER BE LIABLE FOR ANY CLAIM, DAMAGES OR OTHER LIABILITY, INCLUDING ANY GENERAL, SPECIAL, INDIRECT, INCIDENTAL, OR CONSEQUENTIAL DAMAGES, WHETHER IN AN ACTION OF CONTRACT, TORT OR OTHERWISE, ARISING FROM, OUT OF THE USE OR INABILITY TO USE THE FONT SOFTWARE OR FROM OTHER DEALINGS IN THE FONT SOFTWARE.

Mini-XML

URL: <http://www.msweet.org/projects.php?Z3>

Mini-XML License

The Mini-XML library and included programs are provided under the terms of the GNU Library General Public License version 2 (LGPL2) with the following exceptions:

If you link the application to a modified version of Mini-XML, then the changes to Mini-XML must be provided under the terms of the LGPL2 in sections 1, 2, and 4.

GNU LIBRARY GENERAL PUBLIC LICENSE

Version 2, June 1991

Copyright (C) 1991 Free Software Foundation, Inc.

59 Temple Place - Suite 330, Boston, MA 02111-1307, USA

Everyone is permitted to copy and distribute verbatim copies of this license document, but changing it is not allowed.

[This is the first released version of the library GPL. It

is numbered 2 because it goes with version 2 of the ordinary GPL.]

Preamble

The licenses for most software are designed to take away your freedom to share and change it. By contrast, the GNU General Public Licenses are intended to guarantee your freedom to share and change free software--to make sure the software is free for all its users.

This license, the Library General Public License, applies to some specially designated Free Software Foundation software, and to any other libraries whose authors decide to use it. You can use it for your libraries, too.

When we speak of free software, we are referring to freedom, not price. Our General Public Licenses are designed to make sure that you have the freedom to distribute copies of free software (and charge for this service if you wish), that you receive source code or can get it if you want it, that you can change the software or use pieces of it in new free programs; and that you know you can do these things.

To protect your rights, we need to make restrictions that forbid anyone to deny you these rights or to ask you to surrender the rights. These restrictions translate to certain responsibilities for you if you distribute copies of the library, or if you modify it.

For example, if you distribute copies of the library, whether gratis or for a fee, you must give the recipients all the rights that we gave you. You must make sure that they, too, receive or can get the source code. If you link a program with the library, you must provide complete object files to the recipients so that they can relink them with the library, after making changes to the library and recompiling it. And you must show them these terms so they know their rights.

Our method of protecting your rights has two steps: (1) copyright the library, and (2) offer you this license which gives you legal permission to copy, distribute and/or modify the library.

Also, for each distributor's protection, we want to make certain that everyone understands that there is no warranty for this free library. If the library is modified by someone else and passed on, we want its recipients to know that what they have is not the original version, so that any problems introduced by others will not reflect on the original authors' reputations.

Finally, any free program is threatened constantly by software patents. We wish to avoid the danger that companies distributing free software will individually obtain patent licenses, thus in effect transforming the program into proprietary software. To prevent this, we

have made it clear that any patent must be licensed for everyone's free use or not licensed at all.

Most GNU software, including some libraries, is covered by the ordinary GNU General Public License, which was designed for utility programs. This license, the GNU Library General Public License, applies to certain designated libraries. This license is quite different from the ordinary one; be sure to read it in full, and don't assume that anything in it is the same as in the ordinary license.

The reason we have a separate public license for some libraries is that they blur the distinction we usually make between modifying or adding to a program and simply using it. Linking a program with a library, without changing the library, is in some sense simply using the library, and is analogous to running a utility program or application program. However, in a textual and legal sense, the linked executable is a combined work, a derivative of the original library, and the ordinary General Public License treats it as such.

Because of this blurred distinction, using the ordinary General Public License for libraries did not effectively promote software sharing, because most developers did not use the libraries. We concluded that weaker conditions might promote sharing better.

However, unrestricted linking of non-free programs would deprive the users of those programs of all benefit from the free status of the libraries themselves. This Library General Public License is intended to permit developers of non-free programs to use free libraries, while preserving your freedom as a user of such programs to change the free libraries that are incorporated in them. (We have not seen how to achieve this as regards changes in header files, but we have achieved it as regards changes in the actual functions of the Library.) The hope is that this will lead to faster development of free libraries.

The precise terms and conditions for copying, distribution and modification follow. Pay close attention to the difference between a "work based on the library" and a "work that uses the library". The former contains code derived from the library, while the latter only works together with the library.

Note that it is possible for a library to be covered by the ordinary General Public License rather than by this special one.

TERMS AND CONDITIONS FOR COPYING, DISTRIBUTION AND MODIFICATION

A "library" means a collection of software functions and/or data prepared so as to be conveniently linked with application programs (which use some of those functions and data) to form executables.

The "Library", below, refers to any such software

library or work which has been distributed under these terms. A "work based on the Library" means either the Library or any derivative work under copyright law: that is to say, a work containing the Library or a portion of it, either verbatim or with modifications and/or translated straightforwardly into another language. (Hereinafter, translation is included without limitation in the term "modification".)

"Source code" for a work means the preferred form of the work for making modifications to it. For a library, complete source code means all the source code for all modules it contains, plus any associated interface definition files, plus the scripts used to control compilation and installation of the library.

Activities other than copying, distribution and modification are not covered by this License; they are outside its scope. The act of running a program using the Library is not restricted, and output from such a program is covered only if its contents constitute a work based on the Library (independent of the use of the Library in a tool for writing it). Whether that is true depends on what the Library does and what the program that uses the Library does.

You may charge a fee for the physical act of transferring a copy, and you may at your option offer warranty protection in exchange for a fee.

- a) The modified work must itself be a software library.
- b) You must cause the files modified to carry prominent notices stating that you changed the files and the date of any change.
- c) You must cause the whole of the work to be licensed at no charge to all third parties under the terms of this License.
- d) If a facility in the modified Library refers to a function or a table of data to be supplied by an application program that uses the facility, other than as an argument passed when the facility is invoked, then you must make a good faith effort to ensure that, in the event an application does not supply such function or table, the facility still operates, and performs whatever part of its purpose remains meaningful.

(For example, a function in a library to compute square roots has a purpose that is entirely well-defined independent of the application. Therefore, Subsection 2d requires that any application-supplied function or table used by this function must be optional: if the application does not supply it, the square root function must still compute square roots.)

These requirements apply to the modified work as a whole. If identifiable sections of that work are not derived from the Library, and can be reasonably considered independent and separate works in themselves, then this License, and its terms, do not apply to those sections when you distribute them as separate works. But when you distribute the same

sections as part of a whole which is a work based on the Library, the distribution of the whole must be on the terms of this License, whose permissions for other licensees extend to the entire whole, and thus to each and every part regardless of who wrote it.

Thus, it is not the intent of this section to claim rights or contest your rights to work written entirely by you; rather, the intent is to exercise the right to control the distribution of derivative or collective works based on the Library.

In addition, mere aggregation of another work not based on the Library with the Library (or with a work based on the Library) on a volume of a storage or distribution medium does not bring the other work under the scope of this License.

Once this change is made in a given copy, it is irreversible for that copy, so the ordinary GNU General Public License applies to all subsequent copies and derivative works made from that copy.

This option is useful when you wish to copy part of the code of the Library into a program that is not a library.

If distribution of object code is made by offering access to copy from a designated place, then offering equivalent access to copy the source code from the same place satisfies the requirement to distribute the source code, even though third parties are not compelled to copy the source along with the object code.

However, linking a "work that uses the Library" with the Library creates an executable that is a derivative of the Library (because it contains portions of the Library), rather than a "work that uses the library". The executable is therefore covered by this License. Section 6 states terms for distribution of such executables.

When a "work that uses the Library" uses material from a header file that is part of the Library, the object code for the work may be a derivative work of the Library even though the source code is not. Whether this is true is especially significant if the work can be linked without the Library, or if the work is itself a library. The threshold for this to be true is not precisely defined by law.

If such an object file uses only numerical parameters, data structure layouts and accessors, and small macros and small inline functions (ten lines or less in length), then the use of the object file is unrestricted, regardless of whether it is legally a derivative work. (Executables containing this object code plus portions of the Library will still fall under Section 6.)

Otherwise, if the work is a derivative of the Library, you may distribute the object code for the work under the terms of Section 6. Any executables containing that work also fall under Section 6, whether or not they are linked directly with the Library itself.

You must give prominent notice with each copy of the work that the Library is used in it and that the Library and its use are covered by this License. You must supply a copy of this License. If the work during execution displays copyright notices, you must include the copyright notice for the Library among them, as well as a reference directing the user to the copy of this License. Also, you must do one of these things:

a) Accompany the work with the complete corresponding machine-readable source code for the Library including whatever changes were used in the work (which must be distributed under Sections 1 and 2 above); and, if the work is an executable linked with the Library, with the complete machine-readable "work that uses the Library", as object code and/or source code, so that the user can modify the Library and then relink to produce a modified executable containing the modified Library. (It is understood that the user who changes the contents of definitions files in the Library will not necessarily be able to recompile the application to use the modified definitions.)

b) Accompany the work with a written offer, valid for at least three years, to give the same user the materials specified in Subsection 6a, above, for a charge no more than the cost of performing this distribution.

c) If distribution of the work is made by offering access to copy from a designated place, offer equivalent access to copy the above specified materials from the same place.

d) Verify that the user has already received a copy of these materials or that you have already sent this user a copy.

For an executable, the required form of the "work that uses the Library" must include any data and utility programs needed for reproducing the executable from it. However, as a special exception, the source code distributed need not include anything that is normally distributed (in either source or binary form) with the major components (compiler, kernel, and so on) of the operating system on which the executable runs, unless that component itself accompanies the executable.

It may happen that this requirement contradicts the license restrictions of other proprietary libraries that do not normally accompany the operating system. Such a contradiction means you cannot use both them and the Library together in an executable that you distribute.

a) Accompany the combined library with a copy of the same work based on the Library, uncombined with any other library facilities. This must be distributed under the terms of the Sections above.

b) Give prominent notice with the combined library of the fact that part of it is a work based on the Library,

and explaining where to find the accompanying uncombined form of the same work.

If any portion of this section is held invalid or unenforceable under any particular circumstance, the balance of the section is intended to apply, and the section as a whole is intended to apply in other circumstances.

It is not the purpose of this section to induce you to infringe any patents or other property right claims or to contest validity of any such claims; this section has the sole purpose of protecting the integrity of the free software distribution system which is implemented by public license practices. Many people have made generous contributions to the wide range of software distributed through that system in reliance on consistent application of that system; it is up to the author/donor to decide if he or she is willing to distribute software through any other system and a licensee cannot impose that choice.

This section is intended to make thoroughly clear what is believed to be a consequence of the rest of this License.

Each version is given a distinguishing version number. If the Library specifies a version number of this License which applies to it and "any later version", you have the option of following the terms and conditions either of that version or of any later version published by the Free Software Foundation. If the Library does not specify a license version number, you may choose any version ever published by the Free Software Foundation.

NO WARRANTY

END OF TERMS AND CONDITIONS

How to Apply These Terms to Your New Libraries

If you develop a new library, and you want it to be of the greatest possible use to the public, we recommend making it free software that everyone can redistribute and change. You can do so by permitting redistribution under these terms (or, alternatively, under the terms of the ordinary General Public License).

To apply these terms, attach the following notices to the library. It is safest to attach them to the start of each source file to most effectively convey the exclusion of warranty; and each file should have at least the "copyright" line and a pointer to where the full notice is found.

one line to give the library's name and an idea of what it does.

Copyright (C) year name of author

This library is free software; you can redistribute it

and/or modify it under the terms of the GNU Lesser General Public License as published by the Free Software Foundation; either version 2.1 of the License, or (at your option) any later version.

This library is distributed in the hope that it will be useful, but WITHOUT ANY WARRANTY; without even the implied warranty of MERCHANTABILITY or FITNESS FOR A PARTICULAR PURPOSE. See the GNU Lesser General Public License for more details.

You should have received a copy of the GNU Lesser General Public License along with this library; if not, write to the Free Software Foundation, Inc., 59 Temple Place, Suite 330, Boston, MA 02111-1307 USA

Also add information on how to contact you by electronic and paper mail.

You should also get your employer (if you work as a programmer) or your school, if any, to sign a "copyright disclaimer" for the library, if necessary. Here is a sample; alter the names:

Yoyodyne, Inc., hereby disclaims all copyright interest in the library 'Frob' (a library for tweaking knobs) written by James Random Hacker.

signature of Ty Coon, 1 April 1990 Ty Coon, President of Vice

That's all there is to it!

Boost

URL: <http://www.boost.org/>

Boost Software License - Version 1.0 - August 17th, 2003

Permission is hereby granted, free of charge, to any person or organization

obtaining a copy of the software and accompanying documentation covered by

this license (the "Software") to use, reproduce, display, distribute,

execute, and transmit the Software, and to prepare derivative works of the

Software, and to permit third-parties to whom the Software is furnished to

do so, all subject to the following:

The copyright notices in the Software and this entire statement, including

the above license grant, this restriction and the following disclaimer,

must be included in all copies of the Software, in whole or in part, and

all derivative works of the Software, unless such copies or derivative works are solely in the form of machine-executable object code generated by a source language processor.

THE SOFTWARE IS PROVIDED "AS IS", WITHOUT WARRANTY OF ANY KIND, EXPRESS OR IMPLIED, INCLUDING BUT NOT LIMITED TO THE WARRANTIES OF MERCHANTABILITY, FITNESS FOR A PARTICULAR PURPOSE, TITLE AND NON-INFRINGEMENT. IN NO EVENT SHALL THE COPYRIGHT HOLDERS OR ANYONE DISTRIBUTING THE SOFTWARE BE LIABLE FOR ANY DAMAGES OR OTHER LIABILITY, WHETHER IN CONTRACT, TORT OR OTHERWISE, ARISING FROM, OUT OF OR IN CONNECTION WITH THE SOFTWARE OR THE USE OR OTHER DEALINGS IN THE SOFTWARE.

libcurl

URL: <http://curl.haxx.se/>

COPYRIGHT AND PERMISSION NOTICE

Copyright (c) 1996 - 2014, Daniel Stenberg, <daniel@haxx.se>.

All rights reserved.

Permission to use, copy, modify, and distribute this software for any purpose

with or without fee is hereby granted, provided that the above copyright

notice and this permission notice appear in all copies.

THE SOFTWARE IS PROVIDED "AS IS", WITHOUT WARRANTY OF ANY KIND, EXPRESS OR

IMPLIED, INCLUDING BUT NOT LIMITED TO THE WARRANTIES OF MERCHANTABILITY,

FITNESS FOR A PARTICULAR PURPOSE AND NON-INFRINGEMENT OF THIRD PARTY RIGHTS. IN

NO EVENT SHALL THE AUTHORS OR COPYRIGHT HOLDERS BE LIABLE FOR ANY CLAIM,

DAMAGES OR OTHER LIABILITY, WHETHER IN AN ACTION OF CONTRACT, TORT OR

OTHERWISE, ARISING FROM, OUT OF OR IN CONNECTION WITH THE SOFTWARE OR THE USE

OR OTHER DEALINGS IN THE SOFTWARE.

Except as contained in this notice, the name of a copyright holder shall not

be used in advertising or otherwise to promote the

sale, use or other dealings

in this Software without prior written authorization of the copyright holder.

libcurl - lib/krb5.c

URL:

https://github.com/bagder/curl/blob/master/lib/krb5_c

/* GSSAPI/krb5 support for FTP - loosely based on old krb4.c

*

* Copyright (c) 1995, 1996, 1997, 1998, 1999, 2013 Kungliga Tekniska Högskolan

* (Royal Institute of Technology, Stockholm, Sweden).

* Copyright (c) 2004 - 2012 Daniel Stenberg

* All rights reserved.

*

* Redistribution and use in source and binary forms, with or without

* modification, are permitted provided that the following conditions

* are met:

*

* 1. Redistributions of source code must retain the above copyright

* notice, this list of conditions and the following disclaimer.

*

* 2. Redistributions in binary form must reproduce the above copyright

* notice, this list of conditions and the following disclaimer in the

* documentation and/or other materials provided with the distribution.

*

* 3. Neither the name of the Institute nor the names of its contributors

* may be used to endorse or promote products derived from this software

* without specific prior written permission.

*

* THIS SOFTWARE IS PROVIDED BY THE INSTITUTE AND CONTRIBUTORS "AS IS" AND

* ANY EXPRESS OR IMPLIED WARRANTIES, INCLUDING, BUT NOT LIMITED TO, THE

* IMPLIED WARRANTIES OF MERCHANTABILITY

AND FITNESS FOR A PARTICULAR PURPOSE

* ARE DISCLAIMED. IN NO EVENT SHALL THE INSTITUTE OR CONTRIBUTORS BE LIABLE FOR ANY DIRECT, INDIRECT, INCIDENTAL, SPECIAL, EXEMPLARY, OR CONSEQUENTIAL DAMAGES (INCLUDING, BUT NOT LIMITED TO, PROCUREMENT OF SUBSTITUTE GOODS OR SERVICES; LOSS OF USE, DATA, OR PROFITS; OR BUSINESS INTERRUPTION) HOWEVER CAUSED AND ON ANY THEORY OF LIABILITY, WHETHER IN CONTRACT, STRICT LIABILITY, OR TORT (INCLUDING NEGLIGENCE OR OTHERWISE) ARISING IN ANY WAY OUT OF THE USE OF THIS SOFTWARE, EVEN IF ADVISED OF THE POSSIBILITY OF SUCH DAMAGE. */

libcurl - lib/security.c

URL:
<https://github.com/bagder/curl/blob/master/lib/security.c>

/* This source code was modified by Martin Hedenfalk <mhe@stacken.kth.se> for

use in Curl. His latest changes were done 2000-09-18.

*

It has since been patched and modified a lot by Daniel Stenberg

<daniel@haxx.se> to make it better applied to curl conditions, and to make

it not use globals, pollute name space and more. This source code awaits a

rewrite to work around the paragraph 2 in the BSD licenses as explained

below.

*

Copyright (c) 1998, 1999, 2013 Kungliga Tekniska Högskolan

(Royal Institute of Technology, Stockholm, Sweden).

*

Copyright (C) 2001 - 2013, Daniel Stenberg, <daniel@haxx.se>, et al.

*

All rights reserved.

*

Redistribution and use in source and binary forms, with or without

modification, are permitted provided that the following conditions

are met:

*

1. Redistributions of source code must retain the above copyright

notice, this list of conditions and the following disclaimer.

*

2. Redistributions in binary form must reproduce the above copyright

notice, this list of conditions and the following disclaimer in the

documentation and/or other materials provided with the distribution.

*

3. Neither the name of the Institute nor the names of its contributors

may be used to endorse or promote products derived from this software

without specific prior written permission.

*

THIS SOFTWARE IS PROVIDED BY THE INSTITUTE AND CONTRIBUTORS "AS IS" AND

ANY EXPRESS OR IMPLIED WARRANTIES, INCLUDING, BUT NOT LIMITED TO, THE

IMPLIED WARRANTIES OF MERCHANTABILITY AND FITNESS FOR A PARTICULAR PURPOSE

ARE DISCLAIMED. IN NO EVENT SHALL THE INSTITUTE OR CONTRIBUTORS BE LIABLE

FOR ANY DIRECT, INDIRECT, INCIDENTAL, SPECIAL, EXEMPLARY, OR CONSEQUENTIAL

DAMAGES (INCLUDING, BUT NOT LIMITED TO, PROCUREMENT OF SUBSTITUTE GOODS

OR SERVICES; LOSS OF USE, DATA, OR PROFITS; OR BUSINESS INTERRUPTION)

HOWEVER CAUSED AND ON ANY THEORY OF LIABILITY, WHETHER IN CONTRACT, STRICT

LIABILITY, OR TORT (INCLUDING NEGLIGENCE OR OTHERWISE) ARISING IN ANY WAY

OUT OF THE USE OF THIS SOFTWARE, EVEN IF ADVISED OF THE POSSIBILITY OF

SUCH DAMAGE. */

David M. Gay's floating point routines

URL: <http://www.netlib.org/fp/>

```
/******  
*****  
*  
* The author of this software is David M. Gay.  
*  
* Copyright (c) 1991, 2000, 2001 by Lucent  
Technologies.  
*  
* Permission to use, copy, modify, and distribute this  
software for any  
* purpose without fee is hereby granted, provided  
that this entire notice  
* is included in all copies of any software which is or  
includes a copy  
* or modification of this software and in all copies of  
the supporting  
* documentation for such software.  
*  
* THIS SOFTWARE IS BEING PROVIDED "AS IS",  
WITHOUT ANY EXPRESS OR IMPLIED  
* WARRANTY. IN PARTICULAR, NEITHER THE  
AUTHOR NOR LUCENT MAKES ANY  
* REPRESENTATION OR WARRANTY OF ANY KIND  
CONCERNING THE MERCHANTABILITY  
* OF THIS SOFTWARE OR ITS FITNESS FOR ANY  
PARTICULAR PURPOSE.  
*  
*****/  
*****/
```

dynamic annotations

URL: <http://code.google.com/p/data-race-test/wiki/DynamicAnnotations>

```
/* Copyright (c) 2008-2009, Google Inc.  
* All rights reserved.  
*  
* Redistribution and use in source and binary forms,  
with or without  
* modification, are permitted provided that the  
following conditions are  
* met:  
*  
* * Redistributions of source code must retain  
the above copyright  
* notice, this list of conditions and the following
```

disclaimer.

```
* * Neither the name of Google Inc. nor the  
names of its  
* contributors may be used to endorse or promote  
products derived from  
* this software without specific prior written  
permission.  
*  
* THIS SOFTWARE IS PROVIDED BY THE  
COPYRIGHT HOLDERS AND CONTRIBUTORS  
* "AS IS" AND ANY EXPRESS OR IMPLIED  
WARRANTIES, INCLUDING, BUT NOT  
* LIMITED TO, THE IMPLIED WARRANTIES OF  
MERCHANTABILITY AND FITNESS FOR  
* A PARTICULAR PURPOSE ARE DISCLAIMED. IN  
NO EVENT SHALL THE COPYRIGHT  
* OWNER OR CONTRIBUTORS BE LIABLE FOR ANY  
DIRECT, INDIRECT, INCIDENTAL,  
* SPECIAL, EXEMPLARY, OR CONSEQUENTIAL  
DAMAGES (INCLUDING, BUT NOT  
* LIMITED TO, PROCUREMENT OF SUBSTITUTE  
GOODS OR SERVICES; LOSS OF USE,  
* DATA, OR PROFITS; OR BUSINESS  
INTERRUPTION) HOWEVER CAUSED AND ON ANY  
* THEORY OF LIABILITY, WHETHER IN CONTRACT,  
STRICT LIABILITY, OR TORT  
* (INCLUDING NEGLIGENCE OR OTHERWISE)  
ARISING IN ANY WAY OUT OF THE USE  
* OF THIS SOFTWARE, EVEN IF ADVISED OF THE  
POSSIBILITY OF SUCH DAMAGE.  
*  
* ---  
* Author: Kostya Serebryany  
*/
```

libevent

URL: <http://libevent.org/>

Libevent is available for use under the following
license, commonly known
as the 3-clause (or "modified") BSD license:

```
=====  
Copyright (c) 2000-2007 Niels Provos  
<provos@citi.umich.edu>  
Copyright (c) 2007-2010 Niels Provos and Nick  
Mathewson
```

Redistribution and use in source and binary forms, with or without

modification, are permitted provided that the following conditions

are met:

notice, this list of conditions and the following disclaimer.

notice, this list of conditions and the following disclaimer in the

documentation and/or other materials provided with the distribution.

derived from this software without specific prior written permission.

THIS SOFTWARE IS PROVIDED BY THE AUTHOR "AS IS" AND ANY EXPRESS OR

IMPLIED WARRANTIES, INCLUDING, BUT NOT LIMITED TO, THE IMPLIED WARRANTIES

OF MERCHANTABILITY AND FITNESS FOR A PARTICULAR PURPOSE ARE DISCLAIMED.

IN NO EVENT SHALL THE AUTHOR BE LIABLE FOR ANY DIRECT, INDIRECT,

INCIDENTAL, SPECIAL, EXEMPLARY, OR CONSEQUENTIAL DAMAGES (INCLUDING, BUT

NOT LIMITED TO, PROCUREMENT OF SUBSTITUTE GOODS OR SERVICES; LOSS OF USE,

DATA, OR PROFITS; OR BUSINESS INTERRUPTION) HOWEVER CAUSED AND ON ANY

THEORY OF LIABILITY, WHETHER IN CONTRACT, STRICT LIABILITY, OR TORT

(INCLUDING NEGLIGENCE OR OTHERWISE) ARISING IN ANY WAY OUT OF THE USE OF

THIS SOFTWARE, EVEN IF ADVISED OF THE POSSIBILITY OF SUCH DAMAGE.

=====

Portions of Libevent are based on works by others, also made available by

them under the three-clause BSD license above. The copyright notices are

available in the corresponding source files; the license is as above. Here's

a list:

Copyright (c) 2000 Dug Song
<dugsong@monkey.org>

Copyright (c) 1993 The Regents of the University of California.

Copyright (c) 1998 Todd C. Miller
<Todd.Miller@courtesan.com>

Copyright (c) 2003 Michael A. Davis
<mike@datanerds.net>

Copyright (c) 2007 Sun Microsystems

Copyright (c) 2006 Maxim Yegorushkin
<maxim.yegorushkin@gmail.com>

Copyright 2002 Niels Provos
<provos@citi.umich.edu>

Netscape Portable Runtime (NSPR)

URL: <http://www.mozilla.org/projects/nspr/>

/* ***** BEGIN LICENSE BLOCK *****

* Version: MPL 1.1/GPL 2.0/LGPL 2.1

*

* The contents of this file are subject to the Mozilla Public License Version

* 1.1 (the "License"); you may not use this file except in compliance with

* the License. You may obtain a copy of the License at

* <http://www.mozilla.org/MPL/>

*

* Software distributed under the License is distributed on an "AS IS" basis,

* WITHOUT WARRANTY OF ANY KIND, either express or implied. See the License

* for the specific language governing rights and limitations under the

* License.

*

* The Original Code is the Netscape Portable Runtime (NSPR).

*

* The Initial Developer of the Original Code is

* Netscape Communications Corporation.

* Portions created by the Initial Developer are Copyright (C) 1998-2000

* the Initial Developer. All Rights Reserved.

*

* Contributor(s):

*

* Alternatively, the contents of this file may be used under the terms of

* either the GNU General Public License Version 2 or later (the "GPL"), or

* the GNU Lesser General Public License Version 2.1 or later (the "LGPL"),

* in which case the provisions of the GPL or the LGPL are applicable instead

* of those above. If you wish to allow use of your version of this file only

* under the terms of either the GPL or the LGPL, and not to allow others to

* use your version of this file under the terms of the MPL, indicate your

* decision by deleting the provisions above and replace them with the notice

* and other provisions required by the GPL or the LGPL. If you do not delete

* the provisions above, a recipient may use your version of this file under

* the terms of any one of the MPL, the GPL or the LGPL.

*

* ***** END LICENSE BLOCK ***** */

Paul Hsieh's SuperFastHash

URL:

<http://www.azillionmonkeys.com/qed/hash.html>

Paul Hsieh OLD BSD license

Copyright (c) 2010, Paul Hsieh

All rights reserved.

Redistribution and use in source and binary forms, with or without modification,

are permitted provided that the following conditions are met:

* Redistributions of source code must retain the above copyright notice, this

list of conditions and the following disclaimer.

* Redistributions in binary form must reproduce the above copyright notice, this

list of conditions and the following disclaimer in the documentation and/or

other materials provided with the distribution.

* Neither my name, Paul Hsieh, nor the names of any other contributors to the

code use may not be used to endorse or promote products derived from this

software without specific prior written permission.

THIS SOFTWARE IS PROVIDED BY THE COPYRIGHT HOLDERS AND CONTRIBUTORS "AS IS" AND

ANY EXPRESS OR IMPLIED WARRANTIES, INCLUDING, BUT NOT LIMITED TO, THE IMPLIED

WARRANTIES OF MERCHANTABILITY AND FITNESS FOR A PARTICULAR PURPOSE ARE

ANY DIRECT, INDIRECT, INCIDENTAL, SPECIAL, EXEMPLARY, OR CONSEQUENTIAL DAMAGES

(INCLUDING, BUT NOT LIMITED TO, PROCUREMENT OF SUBSTITUTE GOODS OR SERVICES;

LOSS OF USE, DATA, OR PROFITS; OR BUSINESS INTERRUPTION) HOWEVER CAUSED AND ON

ANY THEORY OF LIABILITY, WHETHER IN CONTRACT, STRICT LIABILITY, OR TORT

(INCLUDING NEGLIGENCE OR OTHERWISE) ARISING IN ANY WAY OUT OF THE USE OF THIS

SOFTWARE, EVEN IF ADVISED OF THE POSSIBILITY OF SUCH DAMAGE.

google-glog's symbolization library

URL: <https://github.com/google/glog>

Copyright (c) 2006, Google Inc.

All rights reserved.

Redistribution and use in source and binary forms, with or without modification, are permitted provided that the following conditions are met:

* Redistributions of source code must retain the above copyright notice, this list of conditions and the following disclaimer.

* Redistributions in binary form must reproduce the above copyright notice, this list of conditions and the following disclaimer in the documentation and/or other materials provided with the distribution.

* Neither the name of Google Inc. nor the names of its contributors may be used to endorse or promote products derived from this software without specific prior written permission.

THIS SOFTWARE IS PROVIDED BY THE COPYRIGHT HOLDERS AND CONTRIBUTORS

"AS IS" AND ANY EXPRESS OR IMPLIED WARRANTIES, INCLUDING, BUT NOT

LIMITED TO, THE IMPLIED WARRANTIES OF MERCHANTABILITY AND FITNESS FOR

A PARTICULAR PURPOSE ARE DISCLAIMED. IN NO EVENT SHALL THE COPYRIGHT

OWNER OR CONTRIBUTORS BE LIABLE FOR ANY DIRECT, INDIRECT, INCIDENTAL,

SPECIAL, EXEMPLARY, OR CONSEQUENTIAL

DAMAGES (INCLUDING, BUT NOT LIMITED TO, PROCUREMENT OF SUBSTITUTE GOODS OR SERVICES; LOSS OF USE, DATA, OR PROFITS; OR BUSINESS INTERRUPTION) HOWEVER CAUSED AND ON ANY THEORY OF LIABILITY, WHETHER IN CONTRACT, STRICT LIABILITY, OR TORT (INCLUDING NEGLIGENCE OR OTHERWISE) ARISING IN ANY WAY OUT OF THE USE OF THIS SOFTWARE, EVEN IF ADVISED OF THE POSSIBILITY OF SUCH DAMAGE.

valgrind

URL: <http://valgrind.org>

Notice that the following BSD-style license applies to the Valgrind header

files used by Chromium (valgrind.h and memcheck.h). However, the rest of

Valgrind is licensed under the terms of the GNU General Public License,

version 2, unless otherwise indicated.

Copyright (C) 2000-2008 Julian Seward. All rights reserved.

Redistribution and use in source and binary forms, with or without

modification, are permitted provided that the following conditions

are met:

1. Redistributions of source code must retain the above copyright

notice, this list of conditions and the following disclaimer.

2. The origin of this software must not be misrepresented; you must

not claim that you wrote the original software. If you use this

software in a product, an acknowledgment in the product

documentation would be appreciated but is not required.

3. Altered source versions must be plainly marked

as such, and must

not be misrepresented as being the original software.

4. The name of the author may not be used to endorse or promote

products derived from this software without specific prior written

permission.

THIS SOFTWARE IS PROVIDED BY THE AUTHOR "AS IS" AND ANY EXPRESS

OR IMPLIED WARRANTIES, INCLUDING, BUT NOT LIMITED TO, THE IMPLIED

WARRANTIES OF MERCHANTABILITY AND FITNESS FOR A PARTICULAR PURPOSE

ARE DISCLAIMED. IN NO EVENT SHALL THE AUTHOR BE LIABLE FOR ANY

DIRECT, INDIRECT, INCIDENTAL, SPECIAL, EXEMPLARY, OR CONSEQUENTIAL

DAMAGES (INCLUDING, BUT NOT LIMITED TO, PROCUREMENT OF SUBSTITUTE

GOODS OR SERVICES; LOSS OF USE, DATA, OR PROFITS; OR BUSINESS

INTERRUPTION) HOWEVER CAUSED AND ON ANY THEORY OF LIABILITY,

WHETHER IN CONTRACT, STRICT LIABILITY, OR TORT (INCLUDING

NEGLIGENCE OR OTHERWISE) ARISING IN ANY WAY OUT OF THE USE OF THIS

SOFTWARE, EVEN IF ADVISED OF THE POSSIBILITY OF SUCH DAMAGE.

Mozilla Personal Security Manager

URL: <http://mxr.mozilla.org/mozilla-central/source/security/manager/>

/* ***** BEGIN LICENSE BLOCK *****

* Version: MPL 1.1/GPL 2.0/LGPL 2.1

*

* The contents of this file are subject to the Mozilla Public License Version

* 1.1 (the "License"); you may not use this file except in compliance with

* the License. You may obtain a copy of the License at

* <http://www.mozilla.org/MPL/>

*

* Software distributed under the License is distributed on an "AS IS" basis,

* WITHOUT WARRANTY OF ANY KIND, either express or implied. See the License

* for the specific language governing rights and limitations under the

* License.

*

* The Original Code is the Netscape security libraries.

*

* The Initial Developer of the Original Code is

* Netscape Communications Corporation.

* Portions created by the Initial Developer are Copyright (C) 2000

* the Initial Developer. All Rights Reserved.

*

* Contributor(s):

*

* Alternatively, the contents of this file may be used under the terms of

* either the GNU General Public License Version 2 or later (the "GPL"), or

* the GNU Lesser General Public License Version 2.1 or later (the "LGPL"),

* in which case the provisions of the GPL or the LGPL are applicable instead

* of those above. If you wish to allow use of your version of this file only

* under the terms of either the GPL or the LGPL, and not to allow others to

* use your version of this file under the terms of the MPL, indicate your

* decision by deleting the provisions above and replace them with the notice

* and other provisions required by the GPL or the LGPL. If you do not delete

* the provisions above, a recipient may use your version of this file under

* the terms of any one of the MPL, the GPL or the LGPL.

*

* ***** END LICENSE BLOCK ***** */

Network Security Services (NSS)

URL:

<http://www.mozilla.org/projects/security/pki/nss/>

```
/* ***** BEGIN LICENSE BLOCK *****
 * Version: MPL 1.1/GPL 2.0/LGPL 2.1
 *
 * The contents of this file are subject to the Mozilla
 * Public License Version
 * 1.1 (the "License"); you may not use this file except
 * in compliance with
 * the License. You may obtain a copy of the License
 * at
 * http://www.mozilla.org/MPL/
 *
 * Software distributed under the License is
 * distributed on an "AS IS" basis,
 * WITHOUT WARRANTY OF ANY KIND, either
 * express or implied. See the License
 * for the specific language governing rights and
 * limitations under the
 * License.
 *
 * The Original Code is the Netscape security libraries.
 *
 * The Initial Developer of the Original Code is
 * Netscape Communications Corporation.
 * Portions created by the Initial Developer are
 * Copyright (C) 1994-2000
 * the Initial Developer. All Rights Reserved.
 *
 * Contributor(s):
 *
 * Alternatively, the contents of this file may be used
 * under the terms of
 * either the GNU General Public License Version 2 or
 * later (the "GPL"), or
 * the GNU Lesser General Public License Version 2.1
 * or later (the "LGPL"),
 * in which case the provisions of the GPL or the
 * LGPL are applicable instead
 * of those above. If you wish to allow use of your
 * version of this file only
 * under the terms of either the GPL or the LGPL, and
 * not to allow others to
 * use your version of this file under the terms of the
 * MPL, indicate your
 * decision by deleting the provisions above and
 * replace them with the notice
```

* and other provisions required by the GPL or the LGPL. If you do not delete

* the provisions above, a recipient may use your version of this file under

* the terms of any one of the MPL, the GPL or the LGPL.

*

* ***** END LICENSE BLOCK ***** */

open-vcdiff

URL: <https://github.com/google/open-vcdiff>

Almost Native Graphics Layer Engine

URL: <http://code.google.com/p/angleproject/>

Copyright (C) 2002-2013 The ANGLE Project Authors.

All rights reserved.

Redistribution and use in source and binary forms, with or without modification, are permitted provided that the following conditions are met:

Redistributions of source code must retain the above copyright notice, this list of conditions and the following disclaimer.

Redistributions in binary form must reproduce the above copyright notice, this list of conditions and the following disclaimer in the documentation and/or other materials provided with the distribution.

Neither the name of TransGaming Inc., Google Inc., 3DLabs Inc. Ltd., nor the names of their contributors may be used to endorse or promote products derived from this software without specific prior written permission.

THIS SOFTWARE IS PROVIDED BY THE COPYRIGHT HOLDERS AND CONTRIBUTORS

"AS IS" AND ANY EXPRESS OR IMPLIED WARRANTIES, INCLUDING, BUT NOT

LIMITED TO, THE IMPLIED WARRANTIES OF MERCHANTABILITY AND FITNESS

FOR A PARTICULAR PURPOSE ARE DISCLAIMED. IN NO EVENT SHALL THE

COPYRIGHT OWNER OR CONTRIBUTORS BE LIABLE FOR ANY DIRECT, INDIRECT,

INCIDENTAL, SPECIAL, EXEMPLARY, OR CONSEQUENTIAL DAMAGES (INCLUDING,

BUT NOT LIMITED TO, PROCUREMENT OF SUBSTITUTE GOODS OR SERVICES;

LOSS OF USE, DATA, OR PROFITS; OR BUSINESS INTERRUPTION) HOWEVER

CAUSED AND ON ANY THEORY OF LIABILITY, WHETHER IN CONTRACT, STRICT

LIABILITY, OR TORT (INCLUDING NEGLIGENCE OR OTHERWISE) ARISING IN

ANY WAY OUT OF THE USE OF THIS SOFTWARE, EVEN IF ADVISED OF THE POSSIBILITY OF SUCH DAMAGE.

boringsssl

URL: <https://boringsssl.google.com/boringsssl>

LICENSE ISSUES

=====

The OpenSSL toolkit stays under a dual license, i.e. both the conditions of

the OpenSSL License and the original SSLeay license apply to the toolkit.

See below for the actual license texts. Actually both licenses are BSD-style

Open Source licenses. In case of any license issues related to OpenSSL

please contact openssl-core@openssl.org.

OpenSSL License

/* =====
=====

* Copyright (c) 1998-2011 The OpenSSL Project. All rights reserved.

*

* Redistribution and use in source and binary forms, with or without

* modification, are permitted provided that the following conditions

* are met:

*

* 1. Redistributions of source code must retain the above copyright

* notice, this list of conditions and the following disclaimer.

*

* 2. Redistributions in binary form must reproduce the above copyright

* notice, this list of conditions and the following disclaimer in

* the documentation and/or other materials provided with the

* distribution.

*

* 3. All advertising materials mentioning features or use of this

* software must display the following acknowledgment:

* "This product includes software developed by the OpenSSL Project

* for use in the OpenSSL Toolkit. (http://www.openssl.org/)"

*

* 4. The names "OpenSSL Toolkit" and "OpenSSL Project" must not be used to

* endorse or promote products derived from this software without

* prior written permission. For written permission, please contact

* openssl-core@openssl.org.

*

* 5. Products derived from this software may not be called "OpenSSL"

* nor may "OpenSSL" appear in their names without prior written

* permission of the OpenSSL Project.

*

* 6. Redistributions of any form whatsoever must retain the following

* acknowledgment:

* "This product includes software developed by the OpenSSL Project

* for use in the OpenSSL Toolkit (http://www.openssl.org/)"

*

* THIS SOFTWARE IS PROVIDED BY THE OpenSSL PROJECT ``AS IS'' AND ANY

* EXPRESSED OR IMPLIED WARRANTIES, INCLUDING, BUT NOT LIMITED TO, THE

* IMPLIED WARRANTIES OF MERCHANTABILITY AND FITNESS FOR A PARTICULAR

* PURPOSE ARE DISCLAIMED. IN NO EVENT SHALL THE OpenSSL PROJECT OR

* ITS CONTRIBUTORS BE LIABLE FOR ANY DIRECT, INDIRECT, INCIDENTAL,

* SPECIAL, EXEMPLARY, OR CONSEQUENTIAL DAMAGES (INCLUDING, BUT

* NOT LIMITED TO, PROCUREMENT OF SUBSTITUTE GOODS OR SERVICES;

* LOSS OF USE, DATA, OR PROFITS; OR BUSINESS INTERRUPTION)

* HOWEVER CAUSED AND ON ANY THEORY OF LIABILITY, WHETHER IN CONTRACT,

* STRICT LIABILITY, OR TORT (INCLUDING NEGLIGENCE OR OTHERWISE)

* ARISING IN ANY WAY OUT OF THE USE OF THIS SOFTWARE, EVEN IF ADVISED

* OF THE POSSIBILITY OF SUCH DAMAGE.

* =====

=====

*

* This product includes cryptographic software written by Eric Young

* (eay@cryptsoft.com). This product includes software written by Tim

* Hudson (tjh@cryptsoft.com).

*

*/

Original SSLeay License

/* Copyright (C) 1995-1998 Eric Young (eay@cryptsoft.com)

* All rights reserved.

*

* This package is an SSL implementation written

* by Eric Young (eay@cryptsoft.com).

* The implementation was written so as to conform with Netscapes SSL.

*

* This library is free for commercial and non-commercial use as long as

* the following conditions are aheared to. The following conditions

* apply to all code found in this distribution, be it the RC4, RSA,

* lhash, DES, etc., code; not just the SSL code. The SSL documentation

* included with this distribution is covered by the same copyright terms

* except that the holder is Tim Hudson (tjh@cryptsoft.com).

- * Copyright remains Eric Young's, and as such any Copyright notices in
- * the code are not to be removed.
- * If this package is used in a product, Eric Young should be given attribution
- * as the author of the parts of the library used.
- * This can be in the form of a textual message at program startup or
- * in documentation (online or textual) provided with the package.
- * Redistribution and use in source and binary forms, with or without
- * modification, are permitted provided that the following conditions
- * are met:
- * 1. Redistributions of source code must retain the copyright
- * notice, this list of conditions and the following disclaimer.
- * 2. Redistributions in binary form must reproduce the above copyright
- * notice, this list of conditions and the following disclaimer in the
- * documentation and/or other materials provided with the distribution.
- * 3. All advertising materials mentioning features or use of this software
- * must display the following acknowledgement:
- * "This product includes cryptographic software written by
- * Eric Young (eay@cryptsoft.com)"
- * The word 'cryptographic' can be left out if the routines from the library
- * being used are not cryptographic related :-).
- * 4. If you include any Windows specific code (or a derivative thereof) from
- * the apps directory (application code) you must include an acknowledgement:
- * "This product includes software written by Tim Hudson (tjh@cryptsoft.com)"
- * THIS SOFTWARE IS PROVIDED BY ERIC YOUNG ``AS IS'' AND
- * ANY EXPRESS OR IMPLIED WARRANTIES, INCLUDING, BUT NOT LIMITED TO, THE

- * IMPLIED WARRANTIES OF MERCHANTABILITY AND FITNESS FOR A PARTICULAR PURPOSE
- * ARE DISCLAIMED. IN NO EVENT SHALL THE AUTHOR OR CONTRIBUTORS BE LIABLE
- * FOR ANY DIRECT, INDIRECT, INCIDENTAL, SPECIAL, EXEMPLARY, OR CONSEQUENTIAL
- * DAMAGES (INCLUDING, BUT NOT LIMITED TO, PROCUREMENT OF SUBSTITUTE GOODS
- * OR SERVICES; LOSS OF USE, DATA, OR PROFITS; OR BUSINESS INTERRUPTION)
- * HOWEVER CAUSED AND ON ANY THEORY OF LIABILITY, WHETHER IN CONTRACT, STRICT
- * LIABILITY, OR TORT (INCLUDING NEGLIGENCE OR OTHERWISE) ARISING IN ANY WAY
- * OUT OF THE USE OF THIS SOFTWARE, EVEN IF ADVISED OF THE POSSIBILITY OF
- * SUCH DAMAGE.
- * The licence and distribution terms for any publically available version or
- * derivative of this code cannot be changed. i.e. this code cannot simply be
- * copied and put under another distribution licence
- * [including the GNU Public Licence.]
- */

Brotli

URL: <https://github.com/google/brotli>

Google Cache Invalidation API

URL: https://chromium.googlesource.com/chromium/src/+ /master/third_party/cacheinvalidation/README.chromium

Crashpad

URL: <https://crashpad.chromium.org/>

drawElements Quality Program

URL: <https://source.android.com/devices/graphics/testing.html>

dom-distiller-js

URL: <https://github.com/chromium/dom-distiller>

Copyright 2014 The Chromium Authors. All rights reserved.

Redistribution and use in source and binary forms, with or without

modification, are permitted provided that the following conditions are

met:

* Redistributions of source code must retain the above copyright

notice, this list of conditions and the following disclaimer.

* Redistributions in binary form must reproduce the above

copyright notice, this list of conditions and the following disclaimer

in the documentation and/or other materials provided with the

* Neither the name of Google Inc. nor the names of its

contributors may be used to endorse or promote products derived from

this software without specific prior written permission.

THIS SOFTWARE IS PROVIDED BY THE COPYRIGHT HOLDERS AND CONTRIBUTORS

"AS IS" AND ANY EXPRESS OR IMPLIED WARRANTIES, INCLUDING, BUT NOT

LIMITED TO, THE IMPLIED WARRANTIES OF MERCHANTABILITY AND FITNESS FOR

A PARTICULAR PURPOSE ARE DISCLAIMED. IN NO EVENT SHALL THE COPYRIGHT

OWNER OR CONTRIBUTORS BE LIABLE FOR ANY DIRECT, INDIRECT, INCIDENTAL,

SPECIAL, EXEMPLARY, OR CONSEQUENTIAL DAMAGES (INCLUDING, BUT NOT

LIMITED TO, PROCUREMENT OF SUBSTITUTE GOODS OR SERVICES; LOSS OF USE,

DATA, OR PROFITS; OR BUSINESS INTERRUPTION) HOWEVER CAUSED AND ON ANY

THEORY OF LIABILITY, WHETHER IN CONTRACT, STRICT LIABILITY, OR TORT

(INCLUDING NEGLIGENCE OR OTHERWISE) ARISING IN ANY WAY OUT OF THE USE

OF THIS SOFTWARE, EVEN IF ADVISED OF THE POSSIBILITY OF SUCH DAMAGE.

Parts of the following directories are available under Apache v2.0

src/de

Copyright (c) 2009–2011 Christian Kohlschütter

third_party/gwt_exporter

Copyright 2007 Timepedia.org

third_party/gwt-2.5.1

Copyright 2008 Google

java/org/chromium/distiller/dev

Copyright 2008 Google

Apache License

Version 2.0, January 2004

<http://www.apache.org/licenses/>

TERMS AND CONDITIONS FOR USE, REPRODUCTION, AND DISTRIBUTION

"License" shall mean the terms and conditions for use, reproduction, and distribution as defined by Sections 1 through 9 of this document.

"Licensor" shall mean the copyright owner or entity authorized by the copyright owner that is granting the License.

"Legal Entity" shall mean the union of the acting entity and all other entities that control, are controlled by, or are under common control with that entity. For the purposes of this definition, "control" means (i) the power, direct or indirect, to cause the direction or management of such entity, whether by contract or otherwise, or (ii) ownership of fifty percent (50%) or more of the outstanding shares, or (iii) beneficial ownership of such entity.

"You" (or "Your") shall mean an individual or Legal

Entity exercising permissions granted by this License.

"Source" form shall mean the preferred form for making modifications, including but not limited to software source code, documentation source, and configuration files.

"Object" form shall mean any form resulting from mechanical transformation or translation of a Source form, including but not limited to compiled object code, generated documentation, and conversions to other media types.

"Work" shall mean the work of authorship, whether in Source or Object form, made available under the License, as indicated by a copyright notice that is included in or attached to the work (an example is provided in the Appendix below).

"Derivative Works" shall mean any work, whether in Source or Object form, that is based on (or derived from) the Work and for which the editorial revisions, annotations, elaborations, or other modifications represent, as a whole, an original work of authorship. For the purposes of this License, Derivative Works shall not include works that remain separable from, or merely link (or bind by name) to the interfaces of, the Work and Derivative Works thereof.

"Contribution" shall mean any work of authorship, including the original version of the Work and any modifications or additions to that Work or Derivative Works thereof, that is intentionally submitted to Licensor for inclusion in the Work by the copyright owner or by an individual or Legal Entity authorized to submit on behalf of the copyright owner. For the purposes of this definition, "submitted" means any form of electronic, verbal, or written communication sent to the Licensor or its representatives, including but not limited to communication on electronic mailing lists, source code control systems, and issue tracking systems that are managed by, or on behalf of, the Licensor for the purpose of discussing and improving the Work, but excluding communication that is conspicuously marked or otherwise designated in writing by the copyright owner as "Not a Contribution."

"Contributor" shall mean Licensor and any individual or Legal Entity on behalf of whom a Contribution has been received by Licensor and subsequently incorporated within the Work.

You must give any other recipients of the Work or Derivative Works a copy of this License; and

You must cause any modified files to carry prominent notices stating that You changed the files; and

You must retain, in the Source form of any Derivative Works that You distribute, all copyright, patent, trademark, and attribution notices from the Source form of the Work, excluding those notices that do not pertain to any part of the Derivative Works; and

If the Work includes a "NOTICE" text file as part of its distribution, then any Derivative Works that You distribute must include a readable copy of the attribution notices contained within such NOTICE file, excluding those notices that do not pertain to any part of the Derivative Works, in at least one of the following places: within a NOTICE text file distributed as part of the Derivative Works; within the Source form or documentation, if provided along with the Derivative Works; or, within a display generated by the Derivative Works, if and wherever such third-party notices normally appear. The contents of the NOTICE file are for informational purposes only and do not modify the License. You may add Your own attribution notices within Derivative Works that You distribute, alongside or as an addendum to the NOTICE text from the Work, provided that such additional attribution notices cannot be construed as modifying the License.

You may add Your own copyright statement to Your modifications and may provide additional or different license terms and conditions for use, reproduction, or distribution of Your modifications, or for any such Derivative Works as a whole, provided Your use, reproduction, and distribution of the Work otherwise complies with the conditions stated in this License.

END OF TERMS AND CONDITIONS

Expat XML Parser

URL: <http://sourceforge.net/projects/expat/>

Copyright (c) 1998, 1999, 2000 Thai Open Source Software Center Ltd

and Clark

Cooper

Copyright (c) 2001, 2002, 2003, 2004, 2005, 2006 Expat maintainers.

Permission is hereby granted, free of charge, to any person obtaining

a copy of this software and associated documentation files (the

"Software"), to deal in the Software without restriction, including

without limitation the rights to use, copy, modify, merge, publish, distribute, sublicense, and/or sell copies of the Software, and to permit persons to whom the Software is furnished to do so, subject to the following conditions:

The above copyright notice and this permission notice shall be included in all copies or substantial portions of the Software.

THE SOFTWARE IS PROVIDED "AS IS", WITHOUT WARRANTY OF ANY KIND, EXPRESS OR IMPLIED, INCLUDING BUT NOT LIMITED TO THE WARRANTIES OF MERCHANTABILITY, FITNESS FOR A PARTICULAR PURPOSE AND NONINFRINGEMENT. IN NO EVENT SHALL THE AUTHORS OR COPYRIGHT HOLDERS BE LIABLE FOR ANY CLAIM, DAMAGES OR OTHER LIABILITY, WHETHER IN AN ACTION OF CONTRACT, TORT OR OTHERWISE, ARISING FROM, OUT OF OR IN CONNECTION WITH THE SOFTWARE OR THE USE OR OTHER DEALINGS IN THE SOFTWARE.

fips181

URL: <http://www.adel.nursat.kz/apg/>

Copyright (c) 1999, 2000, 2001, 2002
Adel I. Mirzazhanov. All rights reserved

Redistribution and use in source and binary forms, with or without modification, are permitted provided that the following conditions are met:

1.Redistributions of source code must retain the above copyright notice, this list of conditions and the following disclaimer.

2.Redistributions in binary form must reproduce the above copyright notice, this list of conditions and the following disclaimer in the

documentation and/or other materials provided with the distribution.

3.The name of the author may not be used to endorse or promote products

derived from this software without specific prior written permission.

THIS SOFTWARE IS PROVIDED BY THE AUTHOR "AS IS" AND ANY EXPRESS OR IMPLIED WARRANTIES, INCLUDING, BUT NOT LIMITED TO, THE IMPLIED WARRANTIES OF MERCHANTABILITY AND FITNESS FOR A PARTICULAR PURPOSE ARE DISCLAIMED. IN NO EVENT SHALL THE AUTHOR BE LIABLE FOR ANY DIRECT, INDIRECT, INCIDENTAL, SPECIAL, EXEMPLARY, OR CONSEQUENTIAL DAMAGES (INCLUDING, BUT NOT LIMITED TO, PROCUREMENT OF SUBSTITUTE GOODS OR SERVICES; LOSS OF USE, DATA, OR PROFITS; OR BUSINESS INTERRUPTION) HOWEVER CAUSED AND ON ANY THEORY OF LIABILITY, WHETHER IN CONTRACT, STRICT LIABILITY, OR TORT (INCLUDING NEGLIGENCE OR OTHERWISE) ARISING IN ANY WAY OUT OF THE USE OF THIS SOFTWARE, EVEN IF ADVISED OF THE POSSIBILITY OF SUCH DAMAGE.

flac

URL: <http://sourceforge.net/projects/flac/files/flac-src/flac-1.2.1-src/flac-1.2.1.tar.gz/download>

Copyright (C)
2000,2001,2002,2003,2004,2005,2006,2007 Josh
Coalson

Redistribution and use in source and binary forms, with or without modification, are permitted provided that the following conditions are met:

- Redistributions of source code must retain the above copyright notice, this list of conditions and the following

disclaimer.

- Redistributions in binary form must reproduce the above copyright

notice, this list of conditions and the following disclaimer in the

documentation and/or other materials provided with the distribution.

- Neither the name of the Xiph.org Foundation nor the names of its

contributors may be used to endorse or promote products derived from

this software without specific prior written permission.

THIS SOFTWARE IS PROVIDED BY THE COPYRIGHT HOLDERS AND CONTRIBUTORS

“AS IS” AND ANY EXPRESS OR IMPLIED WARRANTIES, INCLUDING, BUT NOT

LIMITED TO, THE IMPLIED WARRANTIES OF MERCHANTABILITY AND FITNESS FOR

A PARTICULAR PURPOSE ARE DISCLAIMED. IN NO EVENT SHALL THE FOUNDATION OR

CONTRIBUTORS BE LIABLE FOR ANY DIRECT, INDIRECT, INCIDENTAL, SPECIAL,

EXEMPLARY, OR CONSEQUENTIAL DAMAGES (INCLUDING, BUT NOT LIMITED TO,

PROCUREMENT OF SUBSTITUTE GOODS OR SERVICES; LOSS OF USE, DATA, OR

PROFITS; OR BUSINESS INTERRUPTION) HOWEVER CAUSED AND ON ANY THEORY OF

LIABILITY, WHETHER IN CONTRACT, STRICT LIABILITY, OR TORT (INCLUDING

NEGLIGENCE OR OTHERWISE) ARISING IN ANY WAY OUT OF THE USE OF THIS

SOFTWARE, EVEN IF ADVISED OF THE POSSIBILITY OF SUCH DAMAGE.

harfbuzz-ng

URL: <http://harfbuzz.org>

HarfBuzz is licensed under the so-called "Old MIT" license. Details follow.

For parts of HarfBuzz that are licensed under different licenses see individual

files names COPYING in subdirectories where applicable.

Copyright © 2010,2011,2012 Google, Inc.

Copyright © 2012 Mozilla Foundation

Copyright © 2011 Codethink Limited

Copyright © 2008,2010 Nokia Corporation and/or its subsidiary(-ies)

Copyright © 2009 Keith Stribley

Copyright © 2009 Martin Hosken and SIL International

Copyright © 2007 Chris Wilson

Copyright © 2006 Behdad Esfahbod

Copyright © 2005 David Turner

Copyright © 2004,2007,2008,2009,2010 Red Hat, Inc.

Copyright © 1998-2004 David Turner and Werner Lemberg

For full copyright notices consult the individual files in the package.

Permission is hereby granted, without written agreement and without

license or royalty fees, to use, copy, modify, and distribute this

software and its documentation for any purpose, provided that the

above copyright notice and the following two paragraphs appear in

all copies of this software.

IN NO EVENT SHALL THE COPYRIGHT HOLDER BE LIABLE TO ANY PARTY FOR

DIRECT, INDIRECT, SPECIAL, INCIDENTAL, OR CONSEQUENTIAL DAMAGES

ARISING OUT OF THE USE OF THIS SOFTWARE AND ITS DOCUMENTATION, EVEN

IF THE COPYRIGHT HOLDER HAS BEEN ADVISED OF THE POSSIBILITY OF SUCH

THE COPYRIGHT HOLDER SPECIFICALLY DISCLAIMS ANY WARRANTIES, INCLUDING,

BUT NOT LIMITED TO, THE IMPLIED WARRANTIES OF MERCHANTABILITY AND

FITNESS FOR A PARTICULAR PURPOSE. THE SOFTWARE PROVIDED HEREUNDER IS

ON AN "AS IS" BASIS, AND THE COPYRIGHT HOLDER HAS NO OBLIGATION TO

PROVIDE MAINTENANCE, SUPPORT, UPDATES, ENHANCEMENTS, OR MODIFICATIONS.

iccjpeg

URL: <http://www.ijg.org>

The authors make NO WARRANTY or representation, either express or implied,

with respect to this software, its quality, accuracy, merchantability, or

fitness for a particular purpose. This software is provided "AS IS", and you,

its user, assume the entire risk as to its quality and accuracy.

This software is copyright (C) 1991-1998, Thomas G. Lane.

All Rights Reserved except as specified below.

Permission is hereby granted to use, copy, modify, and distribute this

software (or portions thereof) for any purpose, without fee, subject to these

conditions:

(1) If any part of the source code for this software is distributed, then this

README file must be included, with this copyright and no-warranty notice

unaltered; and any additions, deletions, or changes to the original files

must be clearly indicated in accompanying documentation.

(2) If only executable code is distributed, then the accompanying

documentation must state that "this software is based in part on the work of

the Independent JPEG Group".

(3) Permission for use of this software is granted only if the user accepts

full responsibility for any undesirable consequences; the authors accept

NO LIABILITY for damages of any kind.

These conditions apply to any software derived from or based on the IJG code,

not just to the unmodified library. If you use our work, you ought to

acknowledge us.

Permission is NOT granted for the use of any IJG author's name or company name

in advertising or publicity relating to this software or products derived from it.

This software may be referred to only as "the Independent JPEG Group's

software".

We specifically permit and encourage the use of this software as the basis of

commercial products, provided that all warranty or liability claims are

assumed by the product vendor.

icu

URL: <http://site.icu-project.org/>

ICU License - ICU 1.8.1 and later

COPYRIGHT AND PERMISSION NOTICE

Copyright (c) 1995-2014 International Business Machines Corporation and

others

All rights reserved.

Permission is hereby granted, free of charge, to any person obtaining a

copy of this software and associated documentation files (the

"Software"), to deal in the Software without restriction, including

without limitation the rights to use, copy, modify, merge, publish,

distribute, and/or sell copies of the Software, and to permit persons to

whom the Software is furnished to do so, provided that the above

copyright notice(s) and this permission notice appear in all copies of

the Software and that both the above copyright notice(s) and this

permission notice appear in supporting documentation.

THE SOFTWARE IS PROVIDED "AS IS", WITHOUT WARRANTY OF ANY KIND, EXPRESS

OR IMPLIED, INCLUDING BUT NOT LIMITED TO THE WARRANTIES OF

MERCHANTABILITY, FITNESS FOR A PARTICULAR PURPOSE AND NONINFRINGEMENT OF

THIRD PARTY RIGHTS. IN NO EVENT SHALL THE COPYRIGHT HOLDER OR HOLDERS

INCLUDED IN THIS NOTICE BE LIABLE FOR ANY CLAIM, OR ANY SPECIAL INDIRECT

OR CONSEQUENTIAL DAMAGES, OR ANY DAMAGES WHATSOEVER RESULTING FROM LOSS

OF USE, DATA OR PROFITS, WHETHER IN AN ACTION OF CONTRACT, NEGLIGENCE OR

OTHER TORTIOUS ACTION, ARISING OUT OF OR IN CONNECTION WITH THE USE OR

PERFORMANCE OF THIS SOFTWARE.

Except as contained in this notice, the name of a copyright holder shall

not be used in advertising or otherwise to promote the sale, use or

other dealings in this Software without prior written authorization of

the copyright holder.

All trademarks and registered trademarks mentioned herein are the

property of their respective owners.

Third-Party Software Licenses

This section contains third-party software notices and/or additional

terms for licensed third-party software components included within ICU

libraries.

1. Unicode Data Files and Software

COPYRIGHT AND PERMISSION NOTICE

Copyright © 1991-2014 Unicode, Inc. All rights reserved.

Distributed under the Terms of Use in <http://www.unicode.org/copyright.html>.

Permission is hereby granted, free of charge, to any person obtaining

a copy of the Unicode data files and any associated documentation

(the "Data Files") or Unicode software and any associated documentation

(the "Software") to deal in the Data Files or Software without restriction, including without limitation the rights to use,

copy, modify, merge, publish, distribute, and/or sell copies of

the Data Files or Software, and to permit persons to whom the Data Files

or Software are furnished to do so, provided that

(a) this copyright and permission notice appear with all copies

of the Data Files or Software,

(b) this copyright and permission notice appear in associated

documentation, and

(c) there is clear notice in each modified Data File or in the Software

as well as in the documentation associated with the Data File(s) or

Software that the data or software has been modified.

THE DATA FILES AND SOFTWARE ARE PROVIDED "AS IS", WITHOUT WARRANTY OF

ANY KIND, EXPRESS OR IMPLIED, INCLUDING BUT NOT LIMITED TO THE

WARRANTIES OF MERCHANTABILITY, FITNESS FOR A PARTICULAR PURPOSE AND

NONINFRINGEMENT OF THIRD PARTY RIGHTS.

IN NO EVENT SHALL THE COPYRIGHT HOLDER OR HOLDERS INCLUDED IN THIS

NOTICE BE LIABLE FOR ANY CLAIM, OR ANY SPECIAL INDIRECT OR CONSEQUENTIAL

DAMAGES, OR ANY DAMAGES WHATSOEVER
RESULTING FROM LOSS OF USE,
DATA OR PROFITS, WHETHER IN AN ACTION OF
CONTRACT, NEGLIGENCE OR OTHER
TORTIOUS ACTION, ARISING OUT OF OR IN
CONNECTION WITH THE USE OR
PERFORMANCE OF THE DATA FILES OR SOFTWARE.

Except as contained in this notice, the name of a
copyright holder
shall not be used in advertising or otherwise to
promote the sale,
use or other dealings in these Data Files or Software
without prior
written authorization of the copyright holder.

2. Chinese/Japanese Word Break Dictionary Data
(cjdict.txt)

```
# The Google Chrome software developed by  
Google is licensed under the BSD li  
ses, as set forth below.  
#  
# The BSD License  
#  
http://opensource.org/licenses/bsd-license.php  
# Copyright (C) 2006-2008, Google Inc.  
#  
# All rights reserved.  
#  
# Redistribution and use in source and binary  
forms, with or without modifi  
cation, are permitted provided that the following  
conditions are met:  
#  
# Redistributions of source code must retain  
the above copyright notice, th  
is list of conditions and the following disclaimer.  
# Redistributions in binary form must  
reproduce the above copyright notice,  
this list of conditions and the following disclaimer in  
the documentation and/or  
other materials provided with the distribution.  
# Neither the name of Google Inc. nor the  
names of its contributors may be  
used to endorse or promote products derived from
```

```
this software without specific  
prior written permission.  
#  
#  
# THIS SOFTWARE IS PROVIDED BY THE  
COPYRIGHT HOLDERS AND CONTRIBUTORS "AS I  
S" AND ANY EXPRESS OR IMPLIED WARRANTIES,  
INCLUDING, BUT NOT LIMITED TO, THE IMPL  
IED WARRANTIES OF MERCHANTABILITY AND  
FITNESS FOR A PARTICULAR PURPOSE ARE DISCLA  
ECT, INDIRECT, INCIDENTAL, SPECIAL, EXEMPLARY,  
OR CONSEQUENTIAL DAMAGES (INCLUDIN  
G, BUT NOT LIMITED TO, PROCUREMENT OF  
SUBSTITUTE GOODS OR SERVICES; LOSS OF USE,  
DATA, OR PROFITS; OR BUSINESS INTERRUPTION)  
HOWEVER CAUSED AND ON ANY THEORY OF L  
ABILITY, WHETHER IN CONTRACT, STRICT LIABILITY,  
OR TORT (INCLUDING NEGLIGENCE OR  
OTHERWISE) ARISING IN ANY WAY OUT OF THE  
USE OF THIS SOFTWARE, EVEN IF ADVISED O  
F THE POSSIBILITY OF SUCH DAMAGE.  
#  
#  
# The word list in cjdict.txt are generated by  
combining three word lists l  
isted  
# below with further processing for  
compound word breaking. The frequency i  
s generated  
# with an iterative training against Google  
web corpora.  
#  
# * Libtabe (Chinese)  
# -  
https://sourceforge.net/project/?group\_id=1519  
# - Its license terms and conditions are  
shown below.  
#  
# * IPADIC (Japanese)  
# - http://chasen.aist-  
nara.ac.jp/chasen/distribution.html  
# - Its license terms and conditions are  
shown below.  
#  
# -----COPYING.libtabe -----  
BEGIN-----
```

```
#
# /*
# * Copyright (c) 1999 TaBE Project.
# * Copyright (c) 1999 Pai-Hsiang Hsiao.
# * All rights reserved.
# *
# * Redistribution and use in source and
binary forms, with or without
# * modification, are permitted provided
that the following conditions
# * are met:
# *
# * . Redistributions of source code must
retain the above copyright
# * notice, this list of conditions and the
following disclaimer.
# * . Redistributions in binary form must
reproduce the above copyright
# * notice, this list of conditions and the
following disclaimer in
# * the documentation and/or other
materials provided with the
# * distribution.
# * . Neither the name of the TaBE Project
nor the names of its
# * contributors may be used to endorse
or promote products derived
# * from this software without specific
prior written permission.
# *
# * THIS SOFTWARE IS PROVIDED BY THE
COPYRIGHT HOLDERS AND CONTRIBUTORS
# * "AS IS" AND ANY EXPRESS OR IMPLIED
WARRANTIES, INCLUDING, BUT NOT
# * LIMITED TO, THE IMPLIED
WARRANTIES OF MERCHANTABILITY AND FITNESS
# * FOR A PARTICULAR PURPOSE ARE
DISCLAIMED. IN NO EVENT SHALL THE
# * REGENTS OR CONTRIBUTORS BE
LIABLE FOR ANY DIRECT, INDIRECT,
# * INCIDENTAL, SPECIAL, EXEMPLARY, OR
CONSEQUENTIAL DAMAGES
# * (INCLUDING, BUT NOT LIMITED TO,
PROCUREMENT OF SUBSTITUTE GOODS OR
# * SERVICES; LOSS OF USE, DATA, OR
PROFITS; OR BUSINESS INTERRUPTION)
# * HOWEVER CAUSED AND ON ANY
```

```
THEORY OF LIABILITY, WHETHER IN CONTRACT,
# * STRICT LIABILITY, OR TORT (INCLUDING
NEGLIGENCE OR OTHERWISE)
# * ARISING IN ANY WAY OUT OF THE USE
OF THIS SOFTWARE, EVEN IF ADVISED
# * OF THE POSSIBILITY OF SUCH
DAMAGE.
# */
#
# /*
# * Copyright (c) 1999 Computer Systems
and Communication Lab,
# * Institute of
Information Science, Academia Sinica.
# * All rights reserved.
# *
# * Redistribution and use in source and
binary forms, with or without
# * modification, are permitted provided
that the following conditions
# * are met:
# *
# * . Redistributions of source code must
retain the above copyright
# * notice, this list of conditions and the
following disclaimer.
# * . Redistributions in binary form must
reproduce the above copyright
# * notice, this list of conditions and the
following disclaimer in
# * the documentation and/or other
materials provided with the
# * distribution.
# * . Neither the name of the Computer
Systems and Communication Lab
# * nor the names of its contributors may
be used to endorse or
# * promote products derived from this
software without specific
# * prior written permission.
# *
# * THIS SOFTWARE IS PROVIDED BY THE
COPYRIGHT HOLDERS AND CONTRIBUTORS
# * "AS IS" AND ANY EXPRESS OR IMPLIED
WARRANTIES, INCLUDING, BUT NOT
# * LIMITED TO, THE IMPLIED
WARRANTIES OF MERCHANTABILITY AND FITNESS
```

```

# * FOR A PARTICULAR PURPOSE ARE
DISCLAIMED. IN NO EVENT SHALL THE
# * REGENTS OR CONTRIBUTORS BE
LIABLE FOR ANY DIRECT, INDIRECT,
# * INCIDENTAL, SPECIAL, EXEMPLARY, OR
CONSEQUENTIAL DAMAGES
# * (INCLUDING, BUT NOT LIMITED TO,
PROCUREMENT OF SUBSTITUTE GOODS OR
# * SERVICES; LOSS OF USE, DATA, OR
PROFITS; OR BUSINESS INTERRUPTION)
# * HOWEVER CAUSED AND ON ANY
THEORY OF LIABILITY, WHETHER IN CONTRACT,
# * STRICT LIABILITY, OR TORT (INCLUDING
NEGLIGENCE OR OTHERWISE)
# * ARISING IN ANY WAY OUT OF THE USE
OF THIS SOFTWARE, EVEN IF ADVISED
# * OF THE POSSIBILITY OF SUCH
DAMAGE.
# */
#
# Copyright 1996 Chih-Hao Tsai @ Beckman
Institute, University of Illinois
# c-tsai4@uiuc.edu
http://casper.beckman.uiuc.edu/~c-tsai4
#
# -----COPYING.libtabe-----END
-----
-
#
#
# -----COPYING.ipadic-----BEGI
N-----
--
#
# Copyright 2000, 2001, 2002, 2003 Nara
Institute of Science
# and Technology. All Rights Reserved.
#
# Use, reproduction, and distribution of this
software is permitted.
# Any copy of this software, whether in its
original form or modified,
# must include both the above copyright
notice and the following
# paragraphs.
#
# Nara Institute of Science and Technology

```

```

(NAIST),
# the copyright holders, disclaims all
warranties with regard to this
# software, including all implied warranties of
merchantability and
# fitness, in no event shall NAIST be liable for
# any special, indirect or consequential
damages or any damages
# whatsoever resulting from loss of use, data
or profits, whether in an
# action of contract, negligence or other
tortuous action, arising out
# of or in connection with the use or
performance of this software.
#
# A large portion of the dictionary entries
# originate from ICOT Free Software. The
following conditions for ICOT
# Free Software applies to the current
dictionary as well.
#
# Each User may also freely distribute the
Program, whether in its
# original form or modified, to any third party
or parties, PROVIDED
# that the provisions of Section 3 ("NO
WARRANTY") will ALWAYS appear
# on, or be attached to, the Program, which is
distributed substantially
# in the same form as set out herein and that
such intended
# distribution, if actually made, will neither
violate or otherwise
# contravene any of the laws and regulations
of the countries having
# jurisdiction over the User or the intended
distribution itself.
#
# NO WARRANTY
#
# The program was produced on an
experimental basis in the course of the
# research and development conducted
during the project and is provided
# to users as so produced on an
experimental basis. Accordingly, the
# program is provided without any warranty
whatsoever, whether express,

```

implied, statutory or otherwise. The term "warranty" used herein

includes, but is not limited to, any warranty of the quality,

performance, merchantability and fitness for a particular purpose of

the program and the nonexistence of any infringement or violation of

any right of any third party.

#

Each user of the program will agree and understand, and be deemed to

have agreed and understood, that there is no warranty whatsoever for

the program and, accordingly, the entire risk arising from or

otherwise connected with the program is assumed by the user.

#

Therefore, neither ICOT, the copyright holder, or any other

organization that participated in or was otherwise related to the

development of the program and their respective officials, directors,

officers and other employees shall be held liable for any and all

damages, including, without limitation, general, special, incidental

and consequential damages, arising out of or otherwise in connection

with the use or inability to use the program or any product, material

or result produced or otherwise obtained by using the program,

regardless of whether they have been advised of, or otherwise had

knowledge of, the possibility of such damages at any time during the

project or thereafter. Each user will be deemed to have agreed to the

foregoing by his or her commencement of use of the program. The term

"use" as used herein includes, but is not limited to, the use,

modification, copying and distribution of the program and the

production of secondary products from the

program.

#

In the case where the program, whether in its original form or

modified, was distributed or delivered to or received by a user from

any person, organization or entity other than ICOT, unless it makes or

grants independently of ICOT any specific warranty to the user in

writing, such person, organization or entity, will also be exempted

from and not be held liable to the user for any such damages as noted

above as far as the program is concerned.

#

-----COPYING.ipadic-----END-----

3. Lao Word Break Dictionary Data (laodict.txt)

Copyright (c) 2013 International Business Machines Corporation and others. All Rights Reserved.

Project: <http://code.google.com/p/lao-dictionary/>

Dictionary: <http://lao-dictionary.googlecode.com/git/Lao-Dictionary.txt>

License: <http://lao-dictionary.googlecode.com/git/Lao-Dictionary-LICEN>

(copied below)

This file is derived from the above dictionary, with slight modifications.

Copyright (C) 2013 Brian Eugene Wilson, Robert Martin Campbell.

All rights reserved.

Redistribution and use in source and binary forms, with or without modification, are permitted provided that the following conditions are met:

Redistributions of source code must retain the above copyright no

tice, this list of conditions and the following disclaimer. Redistributions

in binary form must reproduce the above copyright notice, this list of cond

itions and the following disclaimer in the documentation and/or other materials provided with the distribution.

THIS SOFTWARE IS PROVIDED BY THE COPYRIGHT HOLDERS AND CONTRIBUTORS "AS IS" AND ANY EXPRESS OR IMPLIED WARRANTIES, INCLUDING, BUT NOT LIMITED TO, THE IMPLIED WARRANTIES OF MERCHANTABILITY AND FITNESS FOR A PARTICULAR PURPOSE ARE DISCLAIMED. IN NO EVENT SHALL THE COPYRIGHT HOLDER OR CONTRIBUTORS BE LIABLE FOR ANY DIRECT, INDIRECT, INCIDENTAL, SPECIAL, EXEMPLARY, OR CONSEQUENTIAL DAMAGES (INCLUDING, BUT NOT LIMITED TO, PROCUREMENT OF SUBSTITUTE GOODS OR SERVICES; LOSS OF USE, DATA, OR PROFITS; OR BUSINESS INTERRUPTION) HOWEVER CAUSED AND ON ANY THEORY OF LIABILITY, WHETHER IN CONTRACT, STRICT LIABILITY, OR TORT (INCLUDING NEGLIGENCE OR OTHERWISE) ARISING IN ANY WAY OUT OF THE USE OF THIS SOFTWARE, EVEN IF ADVISED OF THE POSSIBILITY OF SUCH DAMAGE.

4. Burmese Word Break Dictionary Data
(burmesedict.txt)

Copyright (c) 2014 International Business Machines Corporation and others. All Rights Reserved.

This list is part of a project hosted at:
github.com/kanyawtech/myanmar-karen-word-lists

Copyright (c) 2013, LeRoy Benjamin Sharon
All rights reserved.

Redistribution and use in source and binary forms, with or without modification,

are permitted provided that the following conditions are met:

Redistributions of source code must retain the above copyright notice,

this list of conditions and the following disclaimer.

Redistributions in binary form must reproduce the

above copyright notice

and, this list of conditions and the following disclaimer in the documentation and

or other materials provided with the distribution.

Neither the name Myanmar Karen Word Lists, nor the names of its contributors may be used to endorse or promote products derived from this software without specific prior written permission.

THIS SOFTWARE IS PROVIDED BY THE COPYRIGHT HOLDERS AND CONTRIBUTORS "AS I

S" AND ANY EXPRESS OR IMPLIED WARRANTIES, INCLUDING, BUT NOT LIMITED TO, THE IMP

LIED WARRANTIES OF MERCHANTABILITY AND FITNESS FOR A PARTICULAR PURPOSE ARE

DISCLAIMED. IN NO EVENT SHALL THE COPYRIGHT HOLDER OR CONTRIBUTORS BE LIABLE FOR

ANY DIRECT, INDIRECT, INCIDENTAL, SPECIAL, EXEMPLARY, OR CONSEQUENTIAL DA

MAGES (INCLUDING, BUT NOT LIMITED TO, PROCUREMENT OF SUBSTITUTE GOODS OR SERVIC

ES; LOSS OF USE, DATA, OR PROFITS; OR BUSINESS INTERRUPTION) HOWEVER CAUSED A

ND ON ANY THEORY OF LIABILITY, WHETHER IN CONTRACT, STRICT LIABILITY, OR TORT

(INCLUDING NEGLIGENCE OR OTHERWISE) ARISING IN ANY WAY OUT OF THE USE OF

THIS SOFTWARE, EVEN IF ADVISED OF THE POSSIBILITY OF SUCH DAMAGE.

5. Time Zone Database

ICU uses the public domain data and code derived from Time Zone Database

for its time zone support. The ownership of the TZ database is explained

in BCP 175: Procedure for Maintaining the Time Zone Database section 7.

1 - Database Ownership

The TZ database itself is not an IETF Contribution or an IETF

document. Rather it is a pre-existing and regularly updated work

that is in the public domain, and is intended to remain in the public

domain. Therefore, BCPs 78 [RFC5378] and 79 [RFC3979] do not apply

to the TZ Database or contributions that individuals make to it.

Should any claims be made and substantiated against the TZ Database,

the organization that is providing the IANA Considerations defined in

this RFC, under the memorandum of understanding with the IETF,

currently ICANN, may act in accordance with all competent court

orders. No ownership claims will be made by ICANN or the IETF Trust

on the database or the code. Any person making a contribution to the

database or code waives all rights to future claims in that

contribution or in the TZ Database.

google-jstemplate

URL: <http://code.google.com/p/google-jstemplate/>

Khronos header files

URL: <http://www.khronos.org/registry>

Copyright (c) 2007-2010 The Khronos Group Inc.

Permission is hereby granted, free of charge, to any person obtaining a

copy of this software and/or associated documentation files (the

"Materials"), to deal in the Materials without restriction, including

without limitation the rights to use, copy, modify, merge, publish,

distribute, sublicense, and/or sell copies of the Materials, and to

permit persons to whom the Materials are furnished to do so, subject to

the following conditions:

The above copyright notice and this permission notice shall be included

in all copies or substantial portions of the Materials.

THE MATERIALS ARE PROVIDED "AS IS", WITHOUT WARRANTY OF ANY KIND,

EXPRESS OR IMPLIED, INCLUDING BUT NOT LIMITED TO THE WARRANTIES OF

MERCHANTABILITY, FITNESS FOR A PARTICULAR PURPOSE AND NONINFRINGEMENT.

IN NO EVENT SHALL THE AUTHORS OR COPYRIGHT HOLDERS BE LIABLE FOR ANY

CLAIM, DAMAGES OR OTHER LIABILITY, WHETHER IN AN ACTION OF CONTRACT,

TORT OR OTHERWISE, ARISING FROM, OUT OF OR IN CONNECTION WITH THE

MATERIALS OR THE USE OR OTHER DEALINGS IN THE MATERIALS.

SGI FREE SOFTWARE LICENSE B (Version 2.0, Sept. 18, 2008)

Copyright (C) 1992 Silicon Graphics, Inc. All Rights Reserved.

Permission is hereby granted, free of charge, to any person obtaining a copy of

this software and associated documentation files (the "Software"), to deal in

the Software without restriction, including without limitation the rights to

use, copy, modify, merge, publish, distribute, sublicense, and/or sell copies

of the Software, and to permit persons to whom the Software is furnished to do

so, subject to the following conditions:

The above copyright notice including the dates of first publication and either

this permission notice or a reference to <http://oss.sgi.com/projects/FreeB/>

shall be included in all copies or substantial portions of the Software.

THE SOFTWARE IS PROVIDED "AS IS", WITHOUT WARRANTY OF ANY KIND, EXPRESS OR

IMPLIED, INCLUDING BUT NOT LIMITED TO THE WARRANTIES OF MERCHANTABILITY,

FITNESS FOR A PARTICULAR PURPOSE AND NONINFRINGEMENT. IN NO EVENT SHALL SILICON

GRAPHICS, INC. BE LIABLE FOR ANY CLAIM,

DAMAGES OR OTHER LIABILITY, WHETHER IN AN ACTION OF CONTRACT, TORT OR OTHERWISE, ARISING FROM, OUT OF OR IN CONNECTION WITH THE SOFTWARE OR THE USE OR OTHER DEALINGS IN THE SOFTWARE.

Except as contained in this notice, the name of Silicon Graphics, Inc. shall

not be used in advertising or otherwise to promote the sale, use or other

dealings in this Software without prior written authorization from Silicon

Graphics, Inc.

LevelDB: A Fast Persistent Key-Value Store

URL: <https://github.com/google/leveldb.git>

Copyright (c) 2011 The LevelDB Authors. All rights reserved.

Redistribution and use in source and binary forms, with or without

modification, are permitted provided that the following conditions are

met:

* Redistributions of source code must retain the above copyright

notice, this list of conditions and the following disclaimer.

* Redistributions in binary form must reproduce the above

copyright notice, this list of conditions and the following disclaimer

in the documentation and/or other materials provided with the

* Neither the name of Google Inc. nor the names of its

contributors may be used to endorse or promote products derived from

this software without specific prior written permission.

THIS SOFTWARE IS PROVIDED BY THE COPYRIGHT HOLDERS AND CONTRIBUTORS

"AS IS" AND ANY EXPRESS OR IMPLIED WARRANTIES, INCLUDING, BUT NOT

LIMITED TO, THE IMPLIED WARRANTIES OF

MERCHANTABILITY AND FITNESS FOR A PARTICULAR PURPOSE ARE DISCLAIMED. IN NO EVENT SHALL THE COPYRIGHT

OWNER OR CONTRIBUTORS BE LIABLE FOR ANY DIRECT, INDIRECT, INCIDENTAL,

SPECIAL, EXEMPLARY, OR CONSEQUENTIAL DAMAGES (INCLUDING, BUT NOT

LIMITED TO, PROCUREMENT OF SUBSTITUTE GOODS OR SERVICES; LOSS OF USE,

DATA, OR PROFITS; OR BUSINESS INTERRUPTION) HOWEVER CAUSED AND ON ANY

THEORY OF LIABILITY, WHETHER IN CONTRACT, STRICT LIABILITY, OR TORT

(INCLUDING NEGLIGENCE OR OTHERWISE) ARISING IN ANY WAY OUT OF THE USE

OF THIS SOFTWARE, EVEN IF ADVISED OF THE POSSIBILITY OF SUCH DAMAGE.

The library to input, validate, and display addresses.

URL: <https://github.com/googlei18n/libaddressinput>

libjingle

URL: <http://www.webrtc.org>

libjpeg

URL: <http://www.iijg.org/>

The authors make NO WARRANTY or representation, either express or implied,

with respect to this software, its quality, accuracy, merchantability, or

fitness for a particular purpose. This software is provided "AS IS", and you,

its user, assume the entire risk as to its quality and accuracy.

This software is copyright (C) 1991-1998, Thomas G. Lane.

All Rights Reserved except as specified below.

Permission is hereby granted to use, copy, modify, and distribute this

software (or portions thereof) for any purpose, without fee, subject to these

conditions:

(1) If any part of the source code for this software is distributed, then this

README file must be included, with this copyright and no-warranty notice

unaltered; and any additions, deletions, or changes to the original files

must be clearly indicated in accompanying documentation.

(2) If only executable code is distributed, then the accompanying

documentation must state that "this software is based in part on the work of

the Independent JPEG Group".

(3) Permission for use of this software is granted only if the user accepts

full responsibility for any undesirable consequences; the authors accept

NO LIABILITY for damages of any kind.

These conditions apply to any software derived from or based on the IJG code,

not just to the unmodified library. If you use our work, you ought to

acknowledge us.

Permission is NOT granted for the use of any IJG author's name or company name

in advertising or publicity relating to this software or products derived from it.

This software may be referred to only as "the Independent JPEG Group's software".

We specifically permit and encourage the use of this software as the basis of

commercial products, provided that all warranty or liability claims are

assumed by the product vendor.

sole proprietor of its copyright holder, Aladdin Enterprises of Menlo Park, CA.

by the usual distribution terms of the Free Software Foundation; principally,

that you must include source code if you redistribute it. (See the file ansi2knr.c for

full details.)

However, since ansi2knr.c is not needed as part

of any program generated from the IJG code, this does not limit you more than

the foregoing paragraphs do.

The Unix configuration script "configure" was produced with GNU Autoconf.

It is copyright by the Free Software Foundation but is freely distributable.

The same holds for its supporting scripts (config.guess, config.sub,

ltconfig, ltmain.sh). Another support script, install-sh, is copyright

by M.I.T. but is also freely distributable.

It appears that the arithmetic coding option of the JPEG spec is covered by

patents owned by IBM, AT&T, and Mitsubishi. Hence arithmetic coding cannot

legally be used without obtaining one or more licenses. For this reason,

support for arithmetic coding has been removed from the free JPEG software.

(Since arithmetic coding provides only a marginal gain over the unpatented

Huffman mode, it is unlikely that very many implementations will support it.)

So far as we are aware, there are no patent restrictions on the remaining

The IJG distribution formerly included code to read and write GIF files.

To avoid entanglement with the Unisys LZW patent, GIF reading support has

been removed altogether, and the GIF writer has been simplified to produce

"uncompressed GIFs". This technique does not use the LZW algorithm; the

resulting GIF files are larger than usual, but are readable by all standard

GIF decoders.

We are required to state that

"The Graphics Interchange Format(c) is the

Copyright property of

CompuServe Incorporated. GIF(sm) is a Service Mark property of

CompuServe Incorporated."

Public License.

libjpeg-turbo

URL: <http://sourceforge.net/projects/libjpeg-turbo/>

libjpeg-turbo is licensed under a non-restrictive, BSD-style license

(see README.) The TurboJPEG/OSS wrapper (both C and Java versions) and

associated test programs bear a similar license, which is reproduced below:

Redistribution and use in source and binary forms, with or without

modification, are permitted provided that the following conditions are met:

- Redistributions of source code must retain the above copyright notice,

 this list of conditions and the following disclaimer.

- Redistributions in binary form must reproduce the above copyright notice,

 this list of conditions and the following disclaimer in the documentation

 and/or other materials provided with the distribution.

- Neither the name of the libjpeg-turbo Project nor the names of its

 contributors may be used to endorse or promote products derived from this

 software without specific prior written permission.

THIS SOFTWARE IS PROVIDED BY THE COPYRIGHT HOLDERS AND CONTRIBUTORS "AS IS",

AND ANY EXPRESS OR IMPLIED WARRANTIES, INCLUDING, BUT NOT LIMITED TO, THE

IMPLIED WARRANTIES OF MERCHANTABILITY AND

FITNESS FOR A PARTICULAR PURPOSE

ARE DISCLAIMED. IN NO EVENT SHALL THE COPYRIGHT HOLDERS OR CONTRIBUTORS BE

LIABLE FOR ANY DIRECT, INDIRECT, INCIDENTAL, SPECIAL, EXEMPLARY, OR

CONSEQUENTIAL DAMAGES (INCLUDING, BUT NOT LIMITED TO, PROCUREMENT OF

SUBSTITUTE GOODS OR SERVICES; LOSS OF USE, DATA, OR PROFITS; OR BUSINESS

INTERRUPTION) HOWEVER CAUSED AND ON ANY THEORY OF LIABILITY, WHETHER IN

CONTRACT, STRICT LIABILITY, OR TORT (INCLUDING NEGLIGENCE OR OTHERWISE)

ARISING IN ANY WAY OUT OF THE USE OF THIS SOFTWARE, EVEN IF ADVISED OF THE

POSSIBILITY OF SUCH DAMAGE.

International Phone Number Library

URL:

<http://libphonenumber.googlecode.com/svn/trunk/>

Copyright (C) 2011 Google Inc.

Licensed under the Apache License, Version 2.0 (the "License");

you may not use this file except in compliance with the License.

You may obtain a copy of the License at

<http://www.apache.org/licenses/LICENSE-2.0>

Unless required by applicable law or agreed to in writing, software

distributed under the License is distributed on an "AS IS" BASIS,

WITHOUT WARRANTIES OR CONDITIONS OF ANY KIND, either express or implied.

See the License for the specific language governing permissions and

limitations under the License.

libpng

URL: <http://libpng.org/>

This copy of the libpng notices is provided for your convenience. In case of

any discrepancy between this copy and the notices in the file png.h that is

included in the libpng distribution, the latter shall prevail.

COPYRIGHT NOTICE, DISCLAIMER, and LICENSE:

If you modify libpng you may insert additional notices immediately following

this sentence.

This code is released under the libpng license.

libpng versions 1.0.7, July 1, 2000, through 1.2.54, November 12, 2015, are

Copyright (c) 2000-2002, 2004, 2006-2015 Glenn Randers-Pehrson, are

derived from libpng-1.0.6, and are distributed according to the same

disclaimer and license as libpng-1.0.6 with the following individuals

added to the list of Contributing Authors:

Simon-Pierre Cadieux

Eric S. Raymond

Cosmin Truta

Gilles Vollant

and with the following additions to the disclaimer:

There is no warranty against interference with your enjoyment of the

library or against infringement. There is no warranty that our

efforts or the library will fulfill any of your particular purposes

or needs. This library is provided with all faults, and the entire

risk of satisfactory quality, performance, accuracy, and effort is with

the user.

libpng versions 0.97, January 1998, through 1.0.6, March 20, 2000, are

Copyright (c) 1998-2000 Glenn Randers-Pehrson, are derived from

libpng-0.96, and are distributed according to the same disclaimer and

license as libpng-0.96, with the following individuals added to the list

of Contributing Authors:

Tom Lane

Glenn Randers-Pehrson

Willem van Schaik

libpng versions 0.89, June 1996, through 0.96, May 1997, are

Copyright (c) 1996-1997 Andreas Dilger, are derived from libpng-0.88,

and are distributed according to the same disclaimer and license as

libpng-0.88, with the following individuals added to the list of

Contributing Authors:

John Bowler

Kevin Bracey

Sam Bushell

Magnus Holmgren

Greg Roelofs

Tom Tanner

libpng versions 0.5, May 1995, through 0.88, January 1996, are

Copyright (c) 1995-1996 Guy Eric Schalnat, Group 42, Inc.

For the purposes of this copyright and license, "Contributing Authors"

is defined as the following set of individuals:

Andreas Dilger

Dave Martindale

Guy Eric Schalnat

Paul Schmidt

Tim Wegner

The PNG Reference Library is supplied "AS IS". The Contributing Authors and Group 42, Inc. disclaim all warranties, expressed or implied, including, without limitation, the warranties of merchantability and of fitness for any purpose. The Contributing Authors and Group 42, Inc. assume no liability for direct, indirect, incidental, special, exemplary, or consequential damages, which may result from the use of the PNG Reference Library, even if advised of the possibility of such damage.

Permission is hereby granted to use, copy, modify, and distribute this source code, or portions hereof, for any purpose, without fee, subject to the following restrictions:

1. The origin of this source code must not be misrepresented.
2. Altered versions must be plainly marked as such and must not be misrepresented as being the original source.
3. This Copyright notice may not be removed or altered from any source or altered source distribution.

The Contributing Authors and Group 42, Inc. specifically permit, without fee, and encourage the use of this source code as a component to supporting the PNG file format in commercial products. If you use this source code in a product, acknowledgment is not required but would be

END OF COPYRIGHT NOTICE, DISCLAIMER, and LICENSE.

A "png_get_copyright" function is available, for convenient use in "about" boxes and the like:

```
printf("%s", png_get_copyright(NULL));
```

Also, the PNG logo (in PNG format, of course) is supplied in the files "pngbar.png.jpg" and "pngbar.jpg (88x31) and "pngnow.png.jpg" (98x31).
Libpng is OSI Certified Open Source Software. OSI Certified Open Source is a certification mark of the Open Source Initiative. OSI has not addressed the additional disclaimers inserted at version 1.0.7.

Glenn Randers-Pehrson
glennrp at users.sourceforge.net
November 12, 2015

libsrtip
URL: <https://github.com/cisco/libsrtip>

```
/*  
 *  
 * Copyright (c) 2001-2006 Cisco Systems, Inc.  
 * All rights reserved.  
 *  
 * Redistribution and use in source and binary forms,  
 with or without  
 * modification, are permitted provided that the  
 following conditions  
 * are met:  
 *  
 * Redistributions of source code must retain the  
 above copyright  
 * notice, this list of conditions and the following  
 disclaimer.  
 *  
 * Redistributions in binary form must reproduce  
 the above  
 * copyright notice, this list of conditions and the  
 following  
 * disclaimer in the documentation and/or other  
 materials provided  
 * with the distribution.  
 *
```

* Neither the name of the Cisco Systems, Inc. nor the names of its

* contributors may be used to endorse or promote products derived

* from this software without specific prior written permission.

*

* THIS SOFTWARE IS PROVIDED BY THE COPYRIGHT HOLDERS AND CONTRIBUTORS

* "AS IS" AND ANY EXPRESS OR IMPLIED WARRANTIES, INCLUDING, BUT NOT

* LIMITED TO, THE IMPLIED WARRANTIES OF MERCHANTABILITY AND FITNESS

* FOR A PARTICULAR PURPOSE ARE DISCLAIMED. IN NO EVENT SHALL THE

* COPYRIGHT HOLDERS OR CONTRIBUTORS BE LIABLE FOR ANY DIRECT,

* INDIRECT, INCIDENTAL, SPECIAL, EXEMPLARY, OR CONSEQUENTIAL DAMAGES

* (INCLUDING, BUT NOT LIMITED TO, PROCUREMENT OF SUBSTITUTE GOODS OR

* SERVICES; LOSS OF USE, DATA, OR PROFITS; OR BUSINESS INTERRUPTION)

* HOWEVER CAUSED AND ON ANY THEORY OF LIABILITY, WHETHER IN CONTRACT,

* STRICT LIABILITY, OR TORT (INCLUDING NEGLIGENCE OR OTHERWISE)

* ARISING IN ANY WAY OUT OF THE USE OF THIS SOFTWARE, EVEN IF ADVISED

* OF THE POSSIBILITY OF SUCH DAMAGE.

*

*/

libusbx

URL: <http://libusb.org>

libvpx

URL: <http://www.webmproject.org>

Copyright (c) 2010, The WebM Project authors. All rights reserved.

Redistribution and use in source and binary forms, with or without

modification, are permitted provided that the following conditions are

met:

* Redistributions of source code must retain the above copyright

notice, this list of conditions and the following disclaimer.

* Redistributions in binary form must reproduce the above copyright

notice, this list of conditions and the following disclaimer in

the documentation and/or other materials provided with the distribution.

* Neither the name of Google, nor the WebM Project, nor the names

of its contributors may be used to endorse or promote products

derived from this software without specific prior written

permission.

THIS SOFTWARE IS PROVIDED BY THE COPYRIGHT HOLDERS AND CONTRIBUTORS

"AS IS" AND ANY EXPRESS OR IMPLIED WARRANTIES, INCLUDING, BUT NOT

LIMITED TO, THE IMPLIED WARRANTIES OF MERCHANTABILITY AND FITNESS FOR

A PARTICULAR PURPOSE ARE DISCLAIMED. IN NO EVENT SHALL THE COPYRIGHT

HOLDER OR CONTRIBUTORS BE LIABLE FOR ANY DIRECT, INDIRECT, INCIDENTAL,

SPECIAL, EXEMPLARY, OR CONSEQUENTIAL DAMAGES (INCLUDING, BUT NOT

LIMITED TO, PROCUREMENT OF SUBSTITUTE GOODS OR SERVICES; LOSS OF USE,

DATA, OR PROFITS; OR BUSINESS INTERRUPTION) HOWEVER CAUSED AND ON ANY

THEORY OF LIABILITY, WHETHER IN CONTRACT, STRICT LIABILITY, OR TORT

(INCLUDING NEGLIGENCE OR OTHERWISE) ARISING IN ANY WAY OUT OF THE USE

OF THIS SOFTWARE, EVEN IF ADVISED OF THE POSSIBILITY OF SUCH DAMAGE.

WebP image encoder/decoder

URL: <http://developers.google.com/speed/webp>

Additional IP Rights Grant (Patents)

"These implementations" means the copyrightable works that implement the WebM

codecs distributed by Google as part of the WebM Project.

Google hereby grants to you a perpetual, worldwide, non-exclusive, no-charge,

royalty-free, irrevocable (except as stated in this section) patent license to

make, have made, use, offer to sell, sell, import, transfer, and otherwise

run, modify and propagate the contents of these implementations of WebM, where

such license applies only to those patent claims, both currently owned by

Google and acquired in the future, licensable by Google that are necessarily

infringed by these implementations of WebM. This grant does not include claims

that would be infringed only as a consequence of further modification of these

or agree to the institution of patent litigation or any other patent

enforcement activity against any entity (including a cross-claim or

counterclaim in a lawsuit) alleging that any of these implementations of WebM

or any code incorporated within any of these implementations of WebM

constitute direct or contributory patent infringement, or inducement of

patent infringement, then any patent rights granted to you under this License

for these implementations of WebM shall terminate as of the date such

litigation is filed.

libxml

URL: <http://xmlsoft.org>

Except where otherwise noted in the source code (e.g. the files hash.c,

with different Copyright notices) all the files are:

Copyright (C) 1998-2012 Daniel Veillard. All Rights Reserved.

Permission is hereby granted, free of charge, to any person obtaining a copy

of this software and associated documentation files (the "Software"), to deal

in the Software without restriction, including without limitation the rights

to use, copy, modify, merge, publish, distribute, sublicense, and/or sell

copies of the Software, and to permit persons to whom the Software is fur-

nished to do so, subject to the following conditions:

The above copyright notice and this permission notice shall be included in

all copies or substantial portions of the Software.

THE SOFTWARE IS PROVIDED "AS IS", WITHOUT WARRANTY OF ANY KIND, EXPRESS OR IMPLIED, INCLUDING BUT NOT LIMITED TO THE WARRANTIES OF MERCHANTABILITY, FITNESS FOR A PARTICULAR PURPOSE AND NONINFRINGEMENT. IN NO EVENT SHALL THE AUTHORS OR COPYRIGHT HOLDERS BE LIABLE FOR ANY CLAIM, DAMAGES OR OTHER LIABILITY, WHETHER IN AN ACTION OF CONTRACT, TORT OR OTHERWISE, ARISING FROM, OUT OF OR IN CONNECTION WITH THE SOFTWARE OR THE USE OR OTHER DEALINGS IN THE SOFTWARE.

libxslt

URL: <http://xmlsoft.org/XSLT>

Licence for libxslt except libexslt

Copyright (C) 2001-2002 Daniel Veillard. All Rights Reserved.

Permission is hereby granted, free of charge, to any person obtaining a copy

of this software and associated documentation files (the "Software"), to deal in the Software without restriction, including without limitation the rights to use, copy, modify, merge, publish, distribute, sublicense, and/or sell copies of the Software, and to permit persons to whom the Software is furnished to do so, subject to the following conditions:

The above copyright notice and this permission notice shall be included in all copies or substantial portions of the Software.

THE SOFTWARE IS PROVIDED "AS IS", WITHOUT WARRANTY OF ANY KIND, EXPRESS OR IMPLIED, INCLUDING BUT NOT LIMITED TO THE WARRANTIES OF MERCHANTABILITY, FITNESS FOR A PARTICULAR PURPOSE AND NONINFRINGEMENT. IN NO EVENT SHALL THE DANIEL VEILLARD BE LIABLE FOR ANY CLAIM, DAMAGES OR OTHER LIABILITY, WHETHER IN AN ACTION OF CONTRACT, TORT OR OTHERWISE, ARISING FROM, OUT OF OR IN CONNECTION WITH THE SOFTWARE OR THE USE OR OTHER DEALINGS IN THE SOFTWARE.

Except as contained in this notice, the name of Daniel Veillard shall not be used in advertising or otherwise to promote the sale, use or other dealings in this Software without prior written authorization from him.

Licence for libexslt

Copyright (C) 2001-2002 Thomas Broyer, Charlie Bozeman and Daniel Veillard.
All Rights Reserved.

Permission is hereby granted, free of charge, to any person obtaining a copy of this software and associated documentation files

(the "Software"), to deal in the Software without restriction, including without limitation the rights to use, copy, modify, merge, publish, distribute, sublicense, and/or sell copies of the Software, and to permit persons to whom the Software is furnished to do so, subject to the following conditions:

The above copyright notice and this permission notice shall be included in all copies or substantial portions of the Software.

THE SOFTWARE IS PROVIDED "AS IS", WITHOUT WARRANTY OF ANY KIND, EXPRESS OR IMPLIED, INCLUDING BUT NOT LIMITED TO THE WARRANTIES OF MERCHANTABILITY, FITNESS FOR A PARTICULAR PURPOSE AND NONINFRINGEMENT. IN NO EVENT SHALL THE AUTHORS BE LIABLE FOR ANY CLAIM, DAMAGES OR OTHER LIABILITY, WHETHER IN AN ACTION OF CONTRACT, TORT OR OTHERWISE, ARISING FROM, OUT OF OR IN CONNECTION WITH THE SOFTWARE OR THE USE OR OTHER DEALINGS IN THE SOFTWARE.

Except as contained in this notice, the name of the authors shall not be used in advertising or otherwise to promote the sale, use or other dealings in this Software without prior written authorization from him.

libyuv

URL: <http://code.google.com/p/libyuv/>

Copyright 2011 The LibYuv Project Authors. All rights reserved.

Redistribution and use in source and binary forms, with or without modification, are permitted provided that the following conditions are met:

* Redistributions of source code must retain the above copyright notice, this list of conditions and the following disclaimer.

* Redistributions in binary form must reproduce the above copyright notice, this list of conditions and the following disclaimer in the documentation and/or other materials provided with the distribution.

* Neither the name of Google nor the names of its contributors may be used to endorse or promote products derived from this software without specific prior written permission.

THIS SOFTWARE IS PROVIDED BY THE COPYRIGHT HOLDERS AND CONTRIBUTORS "AS IS" AND ANY EXPRESS OR IMPLIED WARRANTIES, INCLUDING, BUT NOT LIMITED TO, THE IMPLIED WARRANTIES OF MERCHANTABILITY AND FITNESS FOR A PARTICULAR PURPOSE ARE DISCLAIMED. IN NO EVENT SHALL THE COPYRIGHT HOLDER OR CONTRIBUTORS BE LIABLE FOR ANY DIRECT, INDIRECT, INCIDENTAL, SPECIAL, EXEMPLARY, OR CONSEQUENTIAL DAMAGES (INCLUDING, BUT NOT LIMITED TO, PROCUREMENT OF SUBSTITUTE GOODS OR SERVICES; LOSS OF USE, DATA, OR PROFITS; OR BUSINESS INTERRUPTION) HOWEVER CAUSED AND ON ANY THEORY OF LIABILITY, WHETHER IN CONTRACT, STRICT LIABILITY, OR TORT (INCLUDING NEGLIGENCE OR OTHERWISE) ARISING IN ANY WAY OUT OF THE USE OF THIS SOFTWARE, EVEN IF ADVISED OF THE POSSIBILITY OF SUCH DAMAGE.

linux-syscall-support

URL: <http://code.google.com/p/linux-syscall-support/>

// Copyright 2015 The Chromium Authors. All rights reserved.

```
//
// Redistribution and use in source and binary forms,
// with or without
// modification, are permitted provided that the
// following conditions are
// met:
//
// * Redistributions of source code must retain
// the above copyright
// notice, this list of conditions and the following
// disclaimer.
//
// * Redistributions in binary form must reproduce
// the above
// copyright notice, this list of conditions and the
// following disclaimer
// in the documentation and/or other materials
// provided with the
// distribution.
//
// * Neither the name of Google Inc. nor the
// names of its
// contributors may be used to endorse or promote
// products derived from
// this software without specific prior written
// permission.
//
// THIS SOFTWARE IS PROVIDED BY THE
// COPYRIGHT HOLDERS AND CONTRIBUTORS
// "AS IS" AND ANY EXPRESS OR IMPLIED
// WARRANTIES, INCLUDING, BUT NOT
// LIMITED TO, THE IMPLIED WARRANTIES OF
// MERCHANTABILITY AND FITNESS FOR
// A PARTICULAR PURPOSE ARE DISCLAIMED. IN NO
// EVENT SHALL THE COPYRIGHT
// OWNER OR CONTRIBUTORS BE LIABLE FOR ANY
// DIRECT, INDIRECT, INCIDENTAL,
// SPECIAL, EXEMPLARY, OR CONSEQUENTIAL
// DAMAGES (INCLUDING, BUT NOT
// LIMITED TO, PROCUREMENT OF SUBSTITUTE
// GOODS OR SERVICES; LOSS OF USE,
// DATA, OR PROFITS; OR BUSINESS
// INTERRUPTION) HOWEVER CAUSED AND ON ANY
// THEORY OF LIABILITY, WHETHER IN CONTRACT,
// STRICT LIABILITY, OR TORT
// (INCLUDING NEGLIGENCE OR OTHERWISE)
// ARISING IN ANY WAY OUT OF THE USE
// OF THIS SOFTWARE, EVEN IF ADVISED OF THE
// POSSIBILITY OF SUCH DAMAGE.
```

LZ4 - Extremely fast compression

URL: <https://code.google.com/p/lz4/>

LZ4 Library

Copyright (c) 2011-2014, Yann Collet

All rights reserved.

Redistribution and use in source and binary forms, with or without modification,

are permitted provided that the following conditions are met:

* Redistributions of source code must retain the above copyright notice, this

list of conditions and the following disclaimer.

* Redistributions in binary form must reproduce the above copyright notice, this

list of conditions and the following disclaimer in the documentation and/or

other materials provided with the distribution.

THIS SOFTWARE IS PROVIDED BY THE COPYRIGHT HOLDERS AND CONTRIBUTORS "AS IS" AND

ANY EXPRESS OR IMPLIED WARRANTIES, INCLUDING, BUT NOT LIMITED TO, THE IMPLIED

WARRANTIES OF MERCHANTABILITY AND FITNESS FOR A PARTICULAR PURPOSE ARE

ANY DIRECT, INDIRECT, INCIDENTAL, SPECIAL, EXEMPLARY, OR CONSEQUENTIAL DAMAGES

(INCLUDING, BUT NOT LIMITED TO, PROCUREMENT OF SUBSTITUTE GOODS OR SERVICES;

LOSS OF USE, DATA, OR PROFITS; OR BUSINESS INTERRUPTION) HOWEVER CAUSED AND ON

ANY THEORY OF LIABILITY, WHETHER IN CONTRACT, STRICT LIABILITY, OR TORT

(INCLUDING NEGLIGENCE OR OTHERWISE) ARISING IN ANY WAY OUT OF THE USE OF THIS

SOFTWARE, EVEN IF ADVISED OF THE POSSIBILITY OF SUCH DAMAGE.

LZMA SDK

URL: <http://www.7-zip.org/sdk.html>

LZMA SDK is placed in the public domain.

mesa

URL: <http://www.mesa3d.org/>

The default Mesa license is as follows:

Copyright (C) 1999-2007 Brian Paul All Rights Reserved.

Permission is hereby granted, free of charge, to any person obtaining a

copy of this software and associated documentation files (the "Software"),

to deal in the Software without restriction, including without limitation

the rights to use, copy, modify, merge, publish, distribute, sublicense,

and/or sell copies of the Software, and to permit persons to whom the

Software is furnished to do so, subject to the following conditions:

The above copyright notice and this permission notice shall be included

in all copies or substantial portions of the Software.

THE SOFTWARE IS PROVIDED "AS IS", WITHOUT WARRANTY OF ANY KIND, EXPRESS

OR IMPLIED, INCLUDING BUT NOT LIMITED TO THE WARRANTIES OF MERCHANTABILITY,

FITNESS FOR A PARTICULAR PURPOSE AND NONINFRINGEMENT. IN NO EVENT SHALL

BRIAN PAUL BE LIABLE FOR ANY CLAIM, DAMAGES OR OTHER LIABILITY, WHETHER IN

AN ACTION OF CONTRACT, TORT OR OTHERWISE, ARISING FROM, OUT OF OR IN

CONNECTION WITH THE SOFTWARE OR THE USE OR OTHER DEALINGS IN THE SOFTWARE.

Some parts of Mesa are copyrighted under the GNU LGPL. See the

Mesa/docs/COPYRIGHT file for details.

modp base64 decoder

URL: <https://github.com/client9/stringencoders>

* MODP_B64 - High performance base64 encoder/decoder

* Version 1.3 -- 17-Mar-2006

* <http://modp.com/release/base64>

*

* Copyright (c) 2005, 2006 Nick Galbreath -- nickg[at]modp[dot]com

* All rights reserved.

*

* Redistribution and use in source and binary forms, with or without

* modification, are permitted provided that the following conditions are

* met:

*

* Redistributions of source code must retain the above copyright

* notice, this list of conditions and the following disclaimer.

*

* Redistributions in binary form must reproduce the above copyright

* notice, this list of conditions and the following disclaimer in the

* documentation and/or other materials provided with the distribution.

*

* Neither the name of the modp.com nor the names of its

* contributors may be used to endorse or promote products derived from

* this software without specific prior written permission.

*

* THIS SOFTWARE IS PROVIDED BY THE COPYRIGHT HOLDERS AND CONTRIBUTORS

* "AS IS" AND ANY EXPRESS OR IMPLIED WARRANTIES, INCLUDING, BUT NOT

* LIMITED TO, THE IMPLIED WARRANTIES OF MERCHANTABILITY AND FITNESS FOR

* A PARTICULAR PURPOSE ARE DISCLAIMED. IN NO EVENT SHALL THE COPYRIGHT

* OWNER OR CONTRIBUTORS BE LIABLE FOR ANY DIRECT, INDIRECT, INCIDENTAL,

* SPECIAL, EXEMPLARY, OR CONSEQUENTIAL DAMAGES (INCLUDING, BUT NOT

* LIMITED TO, PROCUREMENT OF SUBSTITUTE GOODS OR SERVICES; LOSS OF USE,

* DATA, OR PROFITS; OR BUSINESS

INTERRUPTION) HOWEVER CAUSED AND ON ANY

* THEORY OF LIABILITY, WHETHER IN CONTRACT, STRICT LIABILITY, OR TORT

* (INCLUDING NEGLIGENCE OR OTHERWISE) ARISING IN ANY WAY OUT OF THE USE

* OF THIS SOFTWARE, EVEN IF ADVISED OF THE POSSIBILITY OF SUCH DAMAGE.

Mojo

URL: <https://github.com/domokit/mojo>

// Copyright 2014 The Chromium Authors. All rights reserved.

//

// Redistribution and use in source and binary forms, with or without

// modification, are permitted provided that the following conditions are

// met:

//

// * Redistributions of source code must retain the above copyright

// notice, this list of conditions and the following disclaimer.

// * Redistributions in binary form must reproduce the above

// copyright notice, this list of conditions and the following disclaimer

// in the documentation and/or other materials provided with the

// distribution.

// * Neither the name of Google Inc. nor the names of its

// contributors may be used to endorse or promote products derived from

// this software without specific prior written permission.

//

// THIS SOFTWARE IS PROVIDED BY THE COPYRIGHT HOLDERS AND CONTRIBUTORS

// "AS IS" AND ANY EXPRESS OR IMPLIED WARRANTIES, INCLUDING, BUT NOT

// LIMITED TO, THE IMPLIED WARRANTIES OF MERCHANTABILITY AND FITNESS FOR

// A PARTICULAR PURPOSE ARE DISCLAIMED. IN NO EVENT SHALL THE COPYRIGHT

// OWNER OR CONTRIBUTORS BE LIABLE FOR ANY

DIRECT, INDIRECT, INCIDENTAL,
// SPECIAL, EXEMPLARY, OR CONSEQUENTIAL
DAMAGES (INCLUDING, BUT NOT
// LIMITED TO, PROCUREMENT OF SUBSTITUTE
GOODS OR SERVICES; LOSS OF USE,
// DATA, OR PROFITS; OR BUSINESS
INTERRUPTION) HOWEVER CAUSED AND ON ANY
// THEORY OF LIABILITY, WHETHER IN CONTRACT,
STRICT LIABILITY, OR TORT
// (INCLUDING NEGLIGENCE OR OTHERWISE)
ARISING IN ANY WAY OUT OF THE USE
// OF THIS SOFTWARE, EVEN IF ADVISED OF THE
POSSIBILITY OF SUCH DAMAGE.

mt19937ar

URL: <http://www.math.sci.hiroshima-u.ac.jp/~m-mat/MT/MT2002/emt19937ar.html>

A C-program for MT19937, with initialization
improved 2002/1/26.

Coded by Takuji Nishimura and Makoto
Matsumoto.

Before using, initialize the state by using
init_genrand(seed)

or init_by_array(init_key, key_length).

Copyright (C) 1997 - 2002, Makoto Matsumoto
and Takuji Nishimura,

All rights
reserved.

Redistribution and use in source and binary forms,
with or without

modification, are permitted provided that the
following conditions

are met:

1. Redistributions of source code must retain the
above copyright

notice, this list of conditions and the
following disclaimer.

2. Redistributions in binary form must reproduce
the above copyright

notice, this list of conditions and the
following disclaimer in the

documentation and/or other materials
provided with the distribution.

3. The names of its contributors may not be
used to endorse or promote

products derived from this software without
specific prior written

permission.

THIS SOFTWARE IS PROVIDED BY THE
COPYRIGHT HOLDERS AND CONTRIBUTORS

"AS IS" AND ANY EXPRESS OR IMPLIED
WARRANTIES, INCLUDING, BUT NOT

LIMITED TO, THE IMPLIED WARRANTIES OF
MERCHANTABILITY AND FITNESS FOR

A PARTICULAR PURPOSE ARE DISCLAIMED. IN
NO EVENT SHALL THE COPYRIGHT OWNER OR

CONTRIBUTORS BE LIABLE FOR ANY DIRECT,
INDIRECT, INCIDENTAL, SPECIAL,

EXEMPLARY, OR CONSEQUENTIAL DAMAGES
(INCLUDING, BUT NOT LIMITED TO,

PROCUREMENT OF SUBSTITUTE GOODS OR
SERVICES; LOSS OF USE, DATA, OR

PROFITS; OR BUSINESS INTERRUPTION)
HOWEVER CAUSED AND ON ANY THEORY OF

LIABILITY, WHETHER IN CONTRACT, STRICT
LIABILITY, OR TORT (INCLUDING

NEGLIGENCE OR OTHERWISE) ARISING IN ANY
WAY OUT OF THE USE OF THIS

SOFTWARE, EVEN IF ADVISED OF THE
POSSIBILITY OF SUCH DAMAGE.

Netscape Plugin Application Programming Interface
(NPAPI)

URL: <http://mxr.mozilla.org/mozilla-central/source/modules/plugin/base/public/>

Version: MPL 1.1/GPL 2.0/LGPL 2.1

The contents of this file are subject to the Mozilla
Public License Version

the License. You may obtain a copy of the License at

<http://www.mozilla.org/MPL/>

Software distributed under the License is distributed
on an "AS IS" basis,

WITHOUT WARRANTY OF ANY KIND, either express

or implied. See the License for the specific language governing rights and limitations under the

The Original Code is mozilla.org code.

The Initial Developer of the Original Code is Netscape Communications Corporation.

Portions created by the Initial Developer are Copyright (C) 1998 the Initial Developer. All Rights Reserved.

Contributor(s):

Alternatively, the contents of this file may be used under the terms of

either the GNU General Public License Version 2 or later (the "GPL"), or

the GNU Lesser General Public License Version 2.1 or later (the "LGPL"),

in which case the provisions of the GPL or the LGPL are applicable instead

of those above. If you wish to allow use of your version of this file only

under the terms of either the GPL or the LGPL, and not to allow others to

use your version of this file under the terms of the MPL, indicate your

decision by deleting the provisions above and replace them with the notice

and other provisions required by the GPL or the LGPL. If you do not delete

the provisions above, a recipient may use your version of this file under

the terms of any one of the MPL, the GPL or the LGPL.

OpenMAX DL

URL:

<https://silver.arm.com/download/Software/Graphics/OX000-BU-00010-r1p0-00bet0/OX000-BU-00010-r1p0-00bet0.tgz>

Use of this source code is governed by a BSD-style license that can be

found in the LICENSE file in the root of the source tree. All

contributing project authors may be found in the AUTHORS file in the root of the source tree.

The files were originally licensed by ARM Limited.

The following files:

* dl/api/omxtypes.h

* dl/sp/api/omxSP.h

are licensed by Khronos:

Copyright © 2005–2008 The Khronos Group Inc. All Rights Reserved.

These materials are protected by copyright laws and contain material

proprietary to the Khronos Group, Inc. You may use these materials

for implementing Khronos specifications, without altering or removing

any trademark, copyright or other notice from the specification.

Khronos Group makes no, and expressly disclaims any, representations

or warranties, express or implied, regarding these materials, including,

without limitation, any implied warranties of merchantability or fitness

for a particular purpose or non-infringement of any intellectual property.

Khronos Group makes no, and expressly disclaims any, warranties, express

or implied, regarding the correctness, accuracy, completeness, timeliness,

and reliability of these materials.

Under no circumstances will the Khronos Group, or any of its Promoters,

Contributors or Members or their respective partners, officers, directors,

employees, agents or representatives be liable for any damages, whether

direct, indirect, special or consequential damages for

lost revenues,
lost profits, or otherwise, arising from or in connection
with these

Khronos and OpenMAX are trademarks of the
Khronos Group Inc.

opus

URL: <http://git.xiph.org/?p=opus.git>

Copyright 2001–2011 Xiph.Org, Skype Limited, Octasic,

Jean-Marc Valin, Timothy

B. Terriberry,

CSIRO, Gregory Maxwell,

Mark Borgerding,

Erik de Castro Lopo

Redistribution and use in source and binary forms,
with or without

modification, are permitted provided that the
following conditions

are met:

– Redistributions of source code must retain the
above copyright

notice, this list of conditions and the following
disclaimer.

– Redistributions in binary form must reproduce the
above copyright

notice, this list of conditions and the following
disclaimer in the

documentation and/or other materials provided with
the distribution.

– Neither the name of Internet Society, IETF or IETF
Trust, nor the

names of specific contributors, may be used to
endorse or promote

products derived from this software without specific
prior written

THIS SOFTWARE IS PROVIDED BY THE COPYRIGHT
HOLDERS AND CONTRIBUTORS

“AS IS” AND ANY EXPRESS OR IMPLIED
WARRANTIES, INCLUDING, BUT NOT

LIMITED TO, THE IMPLIED WARRANTIES OF
MERCHANTABILITY AND FITNESS FOR

A PARTICULAR PURPOSE ARE DISCLAIMED. IN NO
EVENT SHALL THE COPYRIGHT OWNER

OR CONTRIBUTORS BE LIABLE FOR ANY DIRECT,
INDIRECT, INCIDENTAL, SPECIAL,

EXEMPLARY, OR CONSEQUENTIAL DAMAGES
(INCLUDING, BUT NOT LIMITED TO,

PROCUREMENT OF SUBSTITUTE GOODS OR
SERVICES; LOSS OF USE, DATA, OR

PROFITS; OR BUSINESS INTERRUPTION) HOWEVER
CAUSED AND ON ANY THEORY OF

LIABILITY, WHETHER IN CONTRACT, STRICT
LIABILITY, OR TORT (INCLUDING

NEGLIGENCE OR OTHERWISE) ARISING IN ANY WAY
OUT OF THE USE OF THIS

SOFTWARE, EVEN IF ADVISED OF THE POSSIBILITY
OF SUCH DAMAGE.

Opus is subject to the royalty-free patent licenses
which are

specified at:

<https://datatracker.ietf.org/ipr/1524/>

Microsoft Corporation:

<https://datatracker.ietf.org/ipr/1914/>

Broadcom Corporation:

<https://datatracker.ietf.org/ipr/1526/>

OTS (OpenType Sanitizer)

URL: <https://github.com/khaledhosny/ots.git>

PLY (Python Lex-Yacc)

URL: <http://www.dabeaz.com/ply/ply-3.4.tar.gz>

PLY (Python Lex-Yacc)

Version 3.4

Protocol Buffers

URL: <http://protobuf.googlecode.com/svn/trunk>

Code generated by the Protocol Buffer compiler is
owned by the owner

of the input file used when generating it. This code is
not

standalone and requires a support library to be linked
with it. This

support library is itself covered by the above license.

Quick Color Management System

URL: <https://github.com/jrmuizel/qcms/tree/v4>

qcms

Copyright (C) 2009 Mozilla Corporation

Copyright (C) 1998-2007 Marti Maria

Permission is hereby granted, free of charge, to any person obtaining

a copy of this software and associated documentation files (the "Software"),

to deal in the Software without restriction, including without limitation

the rights to use, copy, modify, merge, publish, distribute, sublicense,

and/or sell copies of the Software, and to permit persons to whom the Software

is furnished to do so, subject to the following conditions:

The above copyright notice and this permission notice shall be included in

all copies or substantial portions of the Software.

THE SOFTWARE IS PROVIDED "AS IS", WITHOUT WARRANTY OF ANY KIND,

EXPRESS OR IMPLIED, INCLUDING BUT NOT LIMITED TO

THE WARRANTIES OF MERCHANTABILITY, FITNESS FOR A PARTICULAR PURPOSE AND

LIABLE FOR ANY CLAIM, DAMAGES OR OTHER LIABILITY, WHETHER IN AN ACTION

OF CONTRACT, TORT OR OTHERWISE, ARISING FROM, OUT OF OR IN CONNECTION

WITH THE SOFTWARE OR THE USE OR OTHER DEALINGS IN THE SOFTWARE.

re2 - an efficient, principled regular expression library

URL: <https://github.com/google/re2>

sfntly

URL: <https://github.com/googlei18n/sfntly>

Skia

URL: <https://skia.org/>

Some files under resources are under the following license:

Unlimited Commercial Use

We try to make it clear that you may use all clipart from Openclipart even for unlimited commercial use. We believe that giving away our images is a great way to share with the world our talents and that will come back around in a better form.

May I Use Openclipart for?

We put together a small chart of as many possibilities and questions we have heard from people asking how they may use Openclipart. If you have an additional question, please email love@openclipart.org.

All Clipart are Released into the Public Domain.

Each artist at Openclipart releases all rights to the images they share at Openclipart. The reason is so that there is no friction in using and sharing images authors make available at this website so that each artist might also receive the same benefit in using other artists clipart totally for any possible reason.

SMHasher

URL: <http://code.google.com/p/smhasher/>

Snappy: A fast compressor/decompressor

URL: <http://google.github.io/snappy/>

sqlite

URL: <http://sqlite.org/>

The author disclaims copyright to this source code. In place of a legal notice, here is a blessing:

May you do good and not evil.

May you find forgiveness for yourself and forgive others.

May you share freely, never taking more than you give.

tcmalloc

URL: <http://gperftools.googlecode.com/>

The USB ID Repository

URL: <http://www.linux-usb.org/usb-ids.html>

Copyright (c) 2012, Linux USB Project

All rights reserved.

Redistribution and use in source and binary forms, with or without modification, are permitted provided that the following conditions are met:

- o Redistributions of source code must retain the above copyright notice, this list of conditions and the following disclaimer.
- o Redistributions in binary form must reproduce the above copyright notice, this list of conditions and the following disclaimer in the documentation and/or other materials provided with the distribution.
- o Neither the name of the Linux USB Project nor the names of its contributors may be used to endorse or promote products derived from this software without specific prior written permission.

THIS SOFTWARE IS PROVIDED BY THE COPYRIGHT HOLDERS AND CONTRIBUTORS "AS IS" AND ANY EXPRESS OR IMPLIED WARRANTIES, INCLUDING, BUT NOT LIMITED TO, THE IMPLIED WARRANTIES OF MERCHANTABILITY AND FITNESS FOR A PARTICULAR PURPOSE ARE DISCLAIMED. IN NO EVENT SHALL THE COPYRIGHT HOLDER OR CONTRIBUTORS BE LIABLE FOR ANY DIRECT, INDIRECT, INCIDENTAL, SPECIAL, EXEMPLARY, OR CONSEQUENTIAL DAMAGES (INCLUDING, BUT NOT LIMITED TO, PROCUREMENT OF SUBSTITUTE GOODS OR SERVICES; LOSS OF USE, DATA, OR PROFITS; OR BUSINESS INTERRUPTION) HOWEVER CAUSED AND ON ANY THEORY OF LIABILITY, WHETHER IN CONTRACT, STRICT LIABILITY, OR TORT (INCLUDING NEGLIGENCE OR OTHERWISE) ARISING IN ANY WAY OUT OF THE USE OF THIS SOFTWARE, EVEN IF ADVISED OF THE POSSIBILITY OF SUCH DAMAGE.

usrstcp

URL: <http://github.com/sctplab/usrstcp>

(Copied from the COPYRIGHT file of <https://code.google.com/p/sctp-refimpl/source/browse/trunk/COPYRIGHT>)

Copyright (c) 2001, 2002 Cisco Systems, Inc.
Copyright (c) 2002-12 Randall R. Stewart
Copyright (c) 2002-12 Michael Tuexen
All rights reserved.

Redistribution and use in source and binary forms, with or without modification, are permitted provided that the following conditions are met:

- o notice, this list of conditions and the following disclaimer.
- o notice, this list of conditions and the following disclaimer in the documentation and/or other materials provided with the distribution.

THIS SOFTWARE IS PROVIDED BY THE AUTHOR AND CONTRIBUTORS "AS IS" AND ANY EXPRESS OR IMPLIED WARRANTIES, INCLUDING, BUT NOT LIMITED TO, THE IMPLIED WARRANTIES OF MERCHANTABILITY AND FITNESS FOR A PARTICULAR PURPOSE ARE DISCLAIMED. IN NO EVENT SHALL THE AUTHOR OR CONTRIBUTORS BE LIABLE FOR ANY DIRECT, INDIRECT, INCIDENTAL, SPECIAL, EXEMPLARY, OR CONSEQUENTIAL DAMAGES (INCLUDING, BUT NOT LIMITED TO, PROCUREMENT OF SUBSTITUTE GOODS OR SERVICES; LOSS OF USE, DATA, OR PROFITS; OR BUSINESS INTERRUPTION) HOWEVER CAUSED AND ON ANY THEORY OF LIABILITY, WHETHER IN CONTRACT, STRICT LIABILITY, OR TORT (INCLUDING NEGLIGENCE OR OTHERWISE) ARISING IN ANY WAY

OUT OF THE USE OF THIS SOFTWARE, EVEN IF ADVISED OF THE POSSIBILITY OF SUCH DAMAGE.

wayland

URL: <http://wayland.freedesktop.org/>

Copyright © 2008–2012 Kristian Høgsberg

Copyright © 2010–2012 Intel Corporation

Copyright © 2011 Benjamin Franzke

Copyright © 2012 Collabora, Ltd.

Permission is hereby granted, free of charge, to any person obtaining a

copy of this software and associated documentation files (the "Software"),

to deal in the Software without restriction, including without limitation

the rights to use, copy, modify, merge, publish, distribute, sublicense,

and/or sell copies of the Software, and to permit persons to whom the

Software is furnished to do so, subject to the following conditions:

The above copyright notice and this permission notice (including the next

paragraph) shall be included in all copies or substantial portions of the

THE SOFTWARE IS PROVIDED "AS IS", WITHOUT WARRANTY OF ANY KIND, EXPRESS OR

IMPLIED, INCLUDING BUT NOT LIMITED TO THE WARRANTIES OF MERCHANTABILITY,

FITNESS FOR A PARTICULAR PURPOSE AND NONINFRINGEMENT. IN NO EVENT SHALL

THE AUTHORS OR COPYRIGHT HOLDERS BE LIABLE FOR ANY CLAIM, DAMAGES OR OTHER

LIABILITY, WHETHER IN AN ACTION OF CONTRACT, TORT OR OTHERWISE, ARISING

FROM, OUT OF OR IN CONNECTION WITH THE SOFTWARE OR THE USE OR OTHER

DEALINGS IN THE SOFTWARE.

The above is the version of the MIT "Expat" License used by X.org:

<http://cgit.freedesktop.org/xorg/xserver/tree/COPYING>

wayland-protocols

URL: <http://wayland.freedesktop.org/>

Copyright © 2008–2013 Kristian Høgsberg

Copyright © 2010–2013 Intel Corporation

Copyright © 2013 Rafael Antognolli

Copyright © 2013 Jasper St. Pierre

Copyright © 2014 Jonas Ådahl

Copyright © 2014 Jason Ekstrand

Copyright © 2014–2015 Collabora, Ltd.

Copyright © 2015 Red Hat Inc.

Permission is hereby granted, free of charge, to any person obtaining a

copy of this software and associated documentation files (the "Software"),

to deal in the Software without restriction, including without limitation

the rights to use, copy, modify, merge, publish, distribute, sublicense,

and/or sell copies of the Software, and to permit persons to whom the

Software is furnished to do so, subject to the following conditions:

The above copyright notice and this permission notice (including the next

paragraph) shall be included in all copies or substantial portions of the

THE SOFTWARE IS PROVIDED "AS IS", WITHOUT WARRANTY OF ANY KIND, EXPRESS OR

IMPLIED, INCLUDING BUT NOT LIMITED TO THE WARRANTIES OF MERCHANTABILITY,

FITNESS FOR A PARTICULAR PURPOSE AND NONINFRINGEMENT. IN NO EVENT SHALL

THE AUTHORS OR COPYRIGHT HOLDERS BE LIABLE FOR ANY CLAIM, DAMAGES OR OTHER

LIABILITY, WHETHER IN AN ACTION OF CONTRACT,

TORT OR OTHERWISE, ARISING FROM, OUT OF OR IN CONNECTION WITH THE SOFTWARE OR THE USE OR OTHER DEALINGS IN THE SOFTWARE.

The above is the version of the MIT "Expat" License used by X.org:

<http://cgit.freedesktop.org/xorg/xserver/tree/COPYING>

Web Animations JS

URL: <https://github.com/web-animations/web-animations-js>

WebRTC

URL: <http://www.webrtc.org>

Copyright (c) 2011, The WebRTC project authors. All rights reserved.

Redistribution and use in source and binary forms, with or without

modification, are permitted provided that the following conditions are

met:

* Redistributions of source code must retain the above copyright

notice, this list of conditions and the following disclaimer.

* Redistributions in binary form must reproduce the above copyright

notice, this list of conditions and the following disclaimer in

the documentation and/or other materials provided with the

distribution.

* Neither the name of Google nor the names of its contributors may

be used to endorse or promote products derived

from this software

without specific prior written permission.

THIS SOFTWARE IS PROVIDED BY THE COPYRIGHT HOLDERS AND CONTRIBUTORS

"AS IS" AND ANY EXPRESS OR IMPLIED WARRANTIES, INCLUDING, BUT NOT

LIMITED TO, THE IMPLIED WARRANTIES OF MERCHANTABILITY AND FITNESS FOR

A PARTICULAR PURPOSE ARE DISCLAIMED. IN NO EVENT SHALL THE COPYRIGHT

HOLDER OR CONTRIBUTORS BE LIABLE FOR ANY DIRECT, INDIRECT, INCIDENTAL,

SPECIAL, EXEMPLARY, OR CONSEQUENTIAL DAMAGES (INCLUDING, BUT NOT

LIMITED TO, PROCUREMENT OF SUBSTITUTE GOODS OR SERVICES; LOSS OF USE,

DATA, OR PROFITS; OR BUSINESS INTERRUPTION) HOWEVER CAUSED AND ON ANY

THEORY OF LIABILITY, WHETHER IN CONTRACT, STRICT LIABILITY, OR TORT

(INCLUDING NEGLIGENCE OR OTHERWISE) ARISING IN ANY WAY OUT OF THE USE

OF THIS SOFTWARE, EVEN IF ADVISED OF THE POSSIBILITY OF SUCH DAMAGE.

x86inc

URL:

<http://git.videolan.org/?p=x264.git;a=blob:f=common/x86/x86inc.asm>

```
.*****  
,  
*****
```

```
.* x86inc.asm
```

```
.*****  
,  
*****
```

```
.* Copyright (C) 2005-2011 x264 project
```

```
.*  
,
```

```
.* Authors: Loren Merritt <lorenm@u.washington.edu>
```

```
.* Anton Mitrofanov  
<BugMaster@narod.ru>
```

```
.* Jason Garrett-Glaser  
<darkshikari@gmail.com>
```

```
.*  
,
```

```
.* Permission to use, copy, modify, and/or distribute  
this software for any
```

```
.* purpose with or without fee is hereby granted,
```

provided that the above
;* copyright notice and this permission notice appear
in all copies.

```
.*  
,  
;* THE SOFTWARE IS PROVIDED "AS IS" AND THE  
AUTHOR DISCLAIMS ALL WARRANTIES  
;* WITH REGARD TO THIS SOFTWARE INCLUDING  
ALL IMPLIED WARRANTIES OF  
;* MERCHANTABILITY AND FITNESS. IN NO EVENT  
SHALL THE AUTHOR BE LIABLE FOR  
;* ANY SPECIAL, DIRECT, INDIRECT, OR  
CONSEQUENTIAL DAMAGES OR ANY DAMAGES  
;* WHATSOEVER RESULTING FROM LOSS OF USE,  
DATA OR PROFITS, WHETHER IN AN  
;* ACTION OF CONTRACT, NEGLIGENCE OR OTHER  
TORTIOUS ACTION, ARISING OUT OF  
;* OR IN CONNECTION WITH THE USE OR  
PERFORMANCE OF THIS SOFTWARE.  
.*  
*****  
,*  
*****
```

```
;  
; This is a header file for the x264ASM assembly  
language, which uses  
;  
; NASM/YASM syntax combined with a large number  
of macros to provide easy  
;  
; abstraction between different calling conventions  
(x86_32, win64, linux64).  
;  
; It also has various other useful features to simplify  
writing the kind of  
;  
; DSP functions that are most often used in x264.  
;  
;  
; Unlike the rest of x264, this file is available under an  
ISC license, as it  
;  
; has significant usefulness outside of x264 and we  
want it to be available  
;  
; to the largest audience possible. Of course, if you  
modify it for your own  
;  
; purposes to add a new feature, we strongly  
encourage contributing a patch  
;  
; as this feature might be useful for others as well.  
Send patches or ideas  
;  
; to x264-devel@videolan.org .
```

```
zlib  
URL: http://zlib.net/
```

```
/* zlib.h -- interface of the 'zlib' general purpose
```

compression library
version 1.2.4, March 14th, 2010

Copyright (C) 1995-2010 Jean-loup Gailly and Mark Adler

This software is provided 'as-is', without any
express or implied
warranty. In no event will the authors be held
liable for any damages
arising from the use of this software.

Permission is granted to anyone to use this
software for any purpose,
including commercial applications, and to alter it
and redistribute it
freely, subject to the following restrictions:

1. The origin of this software must not be
misrepresented; you must not
claim that you wrote the original software. If
you use this software
in a product, an acknowledgment in the product
documentation would be
appreciated but is not required.
2. Altered source versions must be plainly marked
as such, and must not be
misrepresented as being the original software.
3. This notice may not be removed or altered from
any source distribution.

Jean-loup Gailly
Mark Adler

```
*/
```

url_parse
URL: <http://mxr.mozilla.org/comm-central/source/mozilla/network/base/src/nsURLParsers.cpp>

Copyright 2007, Google Inc.
All rights reserved.

Redistribution and use in source and binary forms,

with or without

modification, are permitted provided that the following conditions are

met:

* Redistributions of source code must retain the above copyright

notice, this list of conditions and the following disclaimer.

* Redistributions in binary form must reproduce the above

copyright notice, this list of conditions and the following disclaimer

in the documentation and/or other materials provided with the

* Neither the name of Google Inc. nor the names of its

contributors may be used to endorse or promote products derived from

this software without specific prior written permission.

THIS SOFTWARE IS PROVIDED BY THE COPYRIGHT HOLDERS AND CONTRIBUTORS

"AS IS" AND ANY EXPRESS OR IMPLIED WARRANTIES, INCLUDING, BUT NOT

LIMITED TO, THE IMPLIED WARRANTIES OF MERCHANTABILITY AND FITNESS FOR

A PARTICULAR PURPOSE ARE DISCLAIMED. IN NO EVENT SHALL THE COPYRIGHT

OWNER OR CONTRIBUTORS BE LIABLE FOR ANY DIRECT, INDIRECT, INCIDENTAL,

SPECIAL, EXEMPLARY, OR CONSEQUENTIAL DAMAGES (INCLUDING, BUT NOT

LIMITED TO, PROCUREMENT OF SUBSTITUTE GOODS OR SERVICES; LOSS OF USE,

DATA, OR PROFITS; OR BUSINESS INTERRUPTION) HOWEVER CAUSED AND ON ANY

THEORY OF LIABILITY, WHETHER IN CONTRACT, STRICT LIABILITY, OR TORT

(INCLUDING NEGLIGENCE OR OTHERWISE) ARISING IN ANY WAY OUT OF THE USE

OF THIS SOFTWARE, EVEN IF ADVISED OF THE POSSIBILITY OF SUCH DAMAGE.

The file url_parse.cc is based on nsURLParsers.cc

from Mozilla. This file is

licensed separately as follows:

The contents of this file are subject to the Mozilla Public License Version

the License. You may obtain a copy of the License at <http://www.mozilla.org/MPL/>

Software distributed under the License is distributed on an "AS IS" basis,

WITHOUT WARRANTY OF ANY KIND, either express or implied. See the License

for the specific language governing rights and limitations under the

The Original Code is mozilla.org code.

The Initial Developer of the Original Code is Netscape Communications Corporation.

Portions created by the Initial Developer are Copyright (C) 1998

the Initial Developer. All Rights Reserved.

Contributor(s):

Darin Fisher (original author)

Alternatively, the contents of this file may be used under the terms of

either the GNU General Public License Version 2 or later (the "GPL"), or

the GNU Lesser General Public License Version 2.1 or later (the "LGPL"),

in which case the provisions of the GPL or the LGPL are applicable instead

of those above. If you wish to allow use of your version of this file only

under the terms of either the GPL or the LGPL, and not to allow others to

use your version of this file under the terms of the MPL, indicate your

decision by deleting the provisions above and replace them with the notice

and other provisions required by the GPL or the LGPL. If you do not delete

the provisions above, a recipient may use your version of this file under

the terms of any one of the MPL, the GPL or the LGPL.

V8 JavaScript Engine

URL: <http://code.google.com/p/v8>

This license applies to all parts of V8 that are not externally

maintained libraries. The externally maintained libraries used by V8

are:

- PCRE test suite, located in

test/mjsunit/third_party/regexp-pcre/regexp-pcre.js. This is based on the

test suite from PCRE-7.3, which is copyrighted by the University

of Cambridge and Google, Inc. The copyright notice and license

are embedded in regexp-pcre.js.

- Layout tests, located in

test/mjsunit/third_party/object-keys. These are

based on layout tests from webkit.org which are copyrighted by

Apple Computer, Inc. and released under a 3-clause BSD license.

- Strongtalk assembler, the basis of the files assembler-arm-inl.h,

assembler-arm.cc, assembler-arm.h, assembler-ia32-inl.h,

assembler-ia32.cc, assembler-ia32.h, assembler-x64-inl.h,

assembler-x64.cc, assembler-x64.h, assembler-mips-inl.h,

assembler-mips.cc, assembler-mips.h, assembler.cc and assembler.h.

This code is copyrighted by Sun Microsystems Inc. and released

under a 3-clause BSD license.

- Valgrind client API header, located at third_party/valgrind/valgrind.h

This is release under the BSD license.

These libraries have their own licenses; we recommend you read them,

as their terms may differ from the terms below.

Further license information can be found in LICENSE files located in

sub-directories.

Copyright 2014, the V8 project authors. All rights reserved.

Redistribution and use in source and binary forms, with or without

modification, are permitted provided that the following conditions are

met:

* Redistributions of source code must retain the above copyright

notice, this list of conditions and the following disclaimer.

* Redistributions in binary form must reproduce the above

copyright notice, this list of conditions and the following

disclaimer in the documentation and/or other materials provided

with the distribution.

* Neither the name of Google Inc. nor the names of its

contributors may be used to endorse or promote products derived

from this software without specific prior written permission.

THIS SOFTWARE IS PROVIDED BY THE COPYRIGHT HOLDERS AND CONTRIBUTORS

"AS IS" AND ANY EXPRESS OR IMPLIED WARRANTIES, INCLUDING, BUT NOT

LIMITED TO, THE IMPLIED WARRANTIES OF MERCHANTABILITY AND FITNESS FOR

A PARTICULAR PURPOSE ARE DISCLAIMED. IN NO EVENT SHALL THE COPYRIGHT

OWNER OR CONTRIBUTORS BE LIABLE FOR ANY DIRECT, INDIRECT, INCIDENTAL,

SPECIAL, EXEMPLARY, OR CONSEQUENTIAL DAMAGES (INCLUDING, BUT NOT

LIMITED TO, PROCUREMENT OF SUBSTITUTE GOODS OR SERVICES; LOSS OF USE,

DATA, OR PROFITS; OR BUSINESS INTERRUPTION) HOWEVER CAUSED AND ON ANY THEORY OF LIABILITY, WHETHER IN CONTRACT, STRICT LIABILITY, OR TORT (INCLUDING NEGLIGENCE OR OTHERWISE) ARISING IN ANY WAY OUT OF THE USE OF THIS SOFTWARE, EVEN IF ADVISED OF THE POSSIBILITY OF SUCH DAMAGE.

fdlibm

URL: <http://www.netlib.org/fdlibm/>

Copyright (C) 1993-2004 by Sun Microsystems, Inc. All rights reserved.

Developed at SunSoft, a Sun Microsystems, Inc. business.

Permission to use, copy, modify, and distribute this software is freely granted, provided that this notice is preserved.

Strongtalk

URL: <http://www.strongtalk.org/>

Copyright (c) 1994-2006 Sun Microsystems Inc. All Rights Reserved.

Redistribution and use in source and binary forms, with or without

modification, are permitted provided that the following conditions are

met:

- Redistributions of source code must retain the above copyright notice, this list of conditions and the following disclaimer.

- Redistribution in binary form must reproduce the above copyright notice, this list of conditions and the following disclaimer in the documentation and/or other materials provided with the distribution.

- Neither the name of Sun Microsystems or the names

of contributors may

be used to endorse or promote products derived from this software without specific prior written permission.

THIS SOFTWARE IS PROVIDED BY THE COPYRIGHT HOLDERS AND CONTRIBUTORS "AS

IS" AND ANY EXPRESS OR IMPLIED WARRANTIES, INCLUDING, BUT NOT LIMITED TO,

THE IMPLIED WARRANTIES OF MERCHANTABILITY AND FITNESS FOR A PARTICULAR

PURPOSE ARE DISCLAIMED. IN NO EVENT SHALL THE COPYRIGHT OWNER OR

CONTRIBUTORS BE LIABLE FOR ANY DIRECT, INDIRECT, INCIDENTAL, SPECIAL,

EXEMPLARY, OR CONSEQUENTIAL DAMAGES (INCLUDING, BUT NOT LIMITED TO,

PROCUREMENT OF SUBSTITUTE GOODS OR SERVICES; LOSS OF USE, DATA, OR

PROFITS; OR BUSINESS INTERRUPTION) HOWEVER CAUSED AND ON ANY THEORY OF

LIABILITY, WHETHER IN CONTRACT, STRICT LIABILITY, OR TORT (INCLUDING

NEGLIGENCE OR OTHERWISE) ARISING IN ANY WAY OUT OF THE USE OF THIS

SOFTWARE, EVEN IF ADVISED OF THE POSSIBILITY OF SUCH DAMAGE.

Extra bundled binaries

name License

libcap URL:

<https://sites.google.com/site/fullycapable/>

Unless otherwise *explicitly* stated, the following text describes the

licensed conditions under which the contents of this libcap release

may be used and distributed:

Redistribution and use in source and binary forms of libcap, with

or without modification, are permitted provided that the following

conditions are met:

notice, and this entire permission notice in its entirety,

including the disclaimer of warranties.

copyright notices, this list of conditions, and the following

disclaimer in the documentation and/or other materials provided

with the distribution.

products derived from this software without their specific prior

written permission.

ALTERNATIVELY, this product may be distributed under the terms of the

GNU General Public License (v2.0 - see below), in which case the

provisions of the GNU GPL are required INSTEAD OF the above restrictions.

(This clause is necessary due to a potential conflict

between the GNU GPL and the restrictions contained in a BSD-style

THIS SOFTWARE IS PROVIDED "AS IS" AND ANY EXPRESS OR IMPLIED

WARRANTIES, INCLUDING, BUT NOT LIMITED TO, THE IMPLIED WARRANTIES OF

MERCHANTABILITY AND FITNESS FOR A PARTICULAR PURPOSE ARE DISCLAIMED.

IN NO EVENT SHALL THE AUTHOR(S) BE LIABLE FOR ANY DIRECT, INDIRECT,

INCIDENTAL, SPECIAL, EXEMPLARY, OR CONSEQUENTIAL DAMAGES (INCLUDING,

BUT NOT LIMITED TO, PROCUREMENT OF SUBSTITUTE GOODS OR SERVICES; LOSS

OF USE, DATA, OR PROFITS; OR BUSINESS INTERRUPTION) HOWEVER CAUSED AND

ON ANY THEORY OF LIABILITY, WHETHER IN CONTRACT, STRICT LIABILITY, OR

TORT (INCLUDING NEGLIGENCE OR OTHERWISE) ARISING IN ANY WAY OUT OF THE

USE OF THIS SOFTWARE, EVEN IF ADVISED OF THE POSSIBILITY OF SUCH DAMAGE.

libnsspem

URL: <https://git.fedorahosted.org/cgi/nss-pem.git>

```
/* ***** BEGIN LICENSE BLOCK *****
```

```
* Version: MPL 1.1/GPL 2.0/LGPL 2.1
```

```
*
```

```
* The contents of this file are subject to the Mozilla Public License Version
```

```
* 1.1 (the "License"); you may not use this file except in compliance with
```

```
* the License. You may obtain a copy of the License at
```

```
* http://www.mozilla.org/MPL/
```

```
*
```

```
* Software distributed under the License is distributed on an "AS IS" basis,
```

```
* WITHOUT WARRANTY OF ANY KIND, either express or implied. See the License
```

```
* for the specific language governing rights and limitations under the
```

```
* License.
```

```
*
```

```
* The Original Code is the Netscape security libraries.
```

```
*
```

```
* The Initial Developer of the Original Code is
```

```
* Netscape Communications Corporation.
```

```
* Portions created by the Initial Developer are Copyright (C) 1994-2000
```

```
* the Initial Developer. All Rights Reserved.
```

```
*
```

```
* Contributor(s):
```

```
* Rob Crittenden (rcritten@redhat.com)
```

```
*
```

```
* Alternatively, the contents of this file may be used under the terms of
```

```
* either the GNU General Public License Version 2 or later (the "GPL"), or
```

```
* the GNU Lesser General Public License Version 2.1 or later (the "LGPL"),
```

```
* in which case the provisions of the GPL or the LGPL are applicable instead
```

```
* of those above. If you wish to allow use of your version of this file only
```

```
* under the terms of either the GPL or the LGPL, and
```

not to allow others to

* use your version of this file under the terms of the MPL, indicate your

* decision by deleting the provisions above and replace them with the notice

* and other provisions required by the GPL or the LGPL. If you do not delete

* the provisions above, a recipient may use your version of this file under

* the terms of any one of the MPL, the GPL or the LGPL.

* ***** END LICENSE BLOCK ***** */

Return to Documentation index.

© Opera TV AS 2015. Confidential information of Opera TV.

BSD LICENSE

Redistribution and use in source and binary forms, with or without modification, are permitted provided that the following conditions are met:

THIS SOFTWARE IS PROVIDED BY THE REGENTS AND CONTRIBUTORS "AS IS" AND ANY EXPRESS OR IMPLIED WARRANTIES, INCLUDING, BUT NOT LIMITED TO, THE IMPLIED WARRANTIES OF MERCHANTABILITY AND FITNESS FOR A PARTICULAR PURPOSE ARE DISCLAIMED. IN NO EVENT SHALL THE REGENTS OR CONTRIBUTORS BE LIABLE FOR ANY DIRECT, INDIRECT, INCIDENTAL, SPECIAL, EXEMPLARY, OR CONSEQUENTIAL DAMAGES (INCLUDING, BUT NOT LIMITED TO, PROCUREMENT OF SUBSTITUTE GOODS OR SERVICES; LOSS OF USE, DATA, OR PROFITS; OR BUSINESS INTERRUPTION) HOWEVER CAUSED AND ON ANY THEORY OF LIABILITY, WHETHER IN CONTRACT, STRICT LIABILITY, OR TORT (INCLUDING NEGLIGENCE OR OTHERWISE) ARISING IN ANY WAY OUT OF THE USE OF THIS SOFTWARE, EVEN IF ADVISED OF THE POSSIBILITY OF SUCH DAMAGE.

MIT LICENSE

Permission is hereby granted, free of charge, to any person obtaining

a copy of this software and associated documentation files (the

"Software"), to deal in the Software without restriction, including

without limitation the rights to use, copy, modify,

merge, publish,

distribute, sublicense, and/or sell copies of the Software, and to

permit persons to whom the Software is furnished to do so, subject to

the following conditions:

The above copyright notice and this permission notice shall be included

in all copies or substantial portions of the Software.

THE SOFTWARE IS PROVIDED "AS IS", WITHOUT WARRANTY OF ANY KIND,

EXPRESS OR IMPLIED, INCLUDING BUT NOT LIMITED TO THE WARRANTIES OF

MERCHANTABILITY, FITNESS FOR A PARTICULAR PURPOSE AND NONINFRINGEMENT.

IN NO EVENT SHALL THE AUTHORS OR COPYRIGHT HOLDERS BE LIABLE FOR ANY

CLAIM, DAMAGES OR OTHER LIABILITY, WHETHER IN AN ACTION OF CONTRACT,

TORT OR OTHERWISE, ARISING FROM, OUT OF OR IN CONNECTION WITH THE

SOFTWARE OR THE USE OR OTHER DEALINGS IN THE SOFTWARE.

This copy of the libpng notices is provided for your convenience. In case of

any discrepancy between this copy and the notices in the file png.h that is

included in the libpng distribution, the latter shall prevail.

COPYRIGHT NOTICE, DISCLAIMER, and LICENSE:

If you modify libpng you may insert additional notices immediately following

this sentence.

This code is released under the libpng license.

libpng versions 1.2.6, August 15, 2004, through 1.4.1, February 25, 2010, are

Copyright (c) 2004, 2006-2007 Glenn Randers-

Pehrson, and are

distributed according to the same disclaimer and license as libpng-1.2.5

with the following individual added to the list of Contributing Authors

Cosmin Truta

libpng versions 1.0.7, July 1, 2000, through 1.2.5 - October 3, 2002, are

Copyright (c) 2000-2002 Glenn Randers-Pehrson, and are

distributed according to the same disclaimer and license as libpng-1.0.6

with the following individuals added to the list of Contributing Authors

Simon-Pierre Cadieux

Eric S. Raymond

Gilles Vollant

and with the following additions to the disclaimer:

There is no warranty against interference with your enjoyment of the

library or against infringement. There is no warranty that our

efforts or the library will fulfill any of your particular purposes

or needs. This library is provided with all faults, and the entire

risk of satisfactory quality, performance, accuracy, and effort is with

the user.

libpng versions 0.97, January 1998, through 1.0.6, March 20, 2000, are

Copyright (c) 1998, 1999 Glenn Randers-Pehrson, and are

distributed according to the same disclaimer and license as libpng-0.96,

with the following individuals added to the list of Contributing Authors:

Tom Lane

Glenn Randers-Pehrson

Willem van Schaik

libpng versions 0.89, June 1996, through 0.96, May 1997, are

Copyright (c) 1996, 1997 Andreas Dilger

Distributed according to the same disclaimer and license as libpng-0.88,

with the following individuals added to the list of Contributing Authors:

John Bowler

Kevin Bracey

Sam Bushell

Magnus Holmgren

Greg Roelofs

Tom Tanner

libpng versions 0.5, May 1995, through 0.88, January 1996, are

Copyright (c) 1995, 1996 Guy Eric Schalnat, Group 42, Inc.

For the purposes of this copyright and license, "Contributing Authors"

is defined as the following set of individuals:

Andreas Dilger

Dave Martindale

Guy Eric Schalnat

Paul Schmidt

Tim Wegner

The PNG Reference Library is supplied "AS IS". The Contributing Authors

and Group 42, Inc. disclaim all warranties, expressed or implied,

including, without limitation, the warranties of merchantability and of

fitness for any purpose. The Contributing Authors and Group 42, Inc.

assume no liability for direct, indirect, incidental, special, exemplary,

or consequential damages, which may result from the use of the PNG

Reference Library, even if advised of the possibility of

such damage.

Permission is hereby granted to use, copy, modify, and distribute this

source code, or portions hereof, for any purpose, without fee, subject

to the following restrictions:

be misrepresented as being the original source.

source or altered source distribution.

The Contributing Authors and Group 42, Inc. specifically permit, without

fee, and encourage the use of this source code as a component to

supporting the PNG file format in commercial products. If you use this

source code in a product, acknowledgment is not required but would be

A "png_get_copyright" function is available, for convenient use in "about"

boxes and the like:

```
printf("%s",png_get_copyright(NULL));
```

Also, the PNG logo (in PNG format, of course) is supplied in the

files "pngbar.png.jpg" and "pngbar.jpg (88x31) and "pngnow.png.jpg" (98x31).

Libpng is OSI Certified Open Source Software. OSI Certified Open Source is a

certification mark of the Open Source Initiative.

Glenn Randers-Pehrson

glennrp at users.sourceforge.net

February 25, 2010

This software is based in part on the work of the FreeType Team.

The FreeType Project
LICENSE

2006-Jan-27

Copyright 1996-2002,
2006 by

David Turner, Robert Wilhelm, and
Werner Lemberg

Introduction

=====

The FreeType Project is distributed in several archive packages;

some of them may contain, in addition to the FreeType font engine,

various tools and contributions which rely on, or relate to, the

FreeType Project.

This license applies to all files found in such packages, and

which do not fall under their own explicit license. The license

affects thus the FreeType font engine, the test programs,

documentation and makefiles, at the very least.

This license was inspired by the BSD, Artistic, and IJG

(Independent JPEG Group) licenses, which all encourage inclusion

and use of free software in commercial and freeware products

alike. As a consequence, its main points are that:

o We don't promise that this software works. However, we will be

interested in any kind of bug reports. ('as is' distribution)

o You can use this software for whatever you

want, in parts or

full form, without having to pay us. ('royalty-free' usage)

o You may not pretend that you wrote this software. If you use

it, or only parts of it, in a program, you must acknowledge

somewhere in your documentation that you have used the

FreeType code. ('credits')

We specifically permit and encourage the inclusion of this

software, with or without modifications, in commercial products.

We disclaim all warranties covering The FreeType Project and

assume no liability related to The FreeType Project.

Finally, many people asked us for a preferred form for a

credit/disclaimer to use in compliance with this license. We thus

encourage you to use the following text:

""

Portions of this software are copyright <year> The FreeType

Project (www.freetype.org). All rights reserved.

""

Please replace <year> with the value from the FreeType version you

actually use.

Legal Terms

Throughout this license, the terms 'package', 'FreeType Project',

and 'FreeType archive' refer to the set of files originally

distributed by the authors (David Turner, Robert Wilhelm, and

Werner Lemberg) as the 'FreeType Project', be they named as alpha,

beta or final release.

'You' refers to the licensee, or person using the project, where

'using' is a generic term including compiling the project's source

code as well as linking it to form a 'program' or 'executable'.

This program is referred to as 'a program using the FreeType

engine'.

This license applies to all files distributed in the original

FreeType Project, including all source code, binaries and

documentation, unless otherwise stated in the file in its

original, unmodified form as distributed in the original archive.

If you are unsure whether or not a particular file is covered by

this license, you must contact us to verify this.

The FreeType Project is copyright (C) 1996-2000 by David Turner,

Robert Wilhelm, and Werner Lemberg. All rights reserved except as

specified below.

THE FREETYPE PROJECT IS PROVIDED 'AS IS' WITHOUT WARRANTY OF ANY

KIND, EITHER EXPRESS OR IMPLIED, INCLUDING, BUT NOT LIMITED TO,

WARRANTIES OF MERCHANTABILITY AND FITNESS FOR A PARTICULAR

PURPOSE. IN NO EVENT WILL ANY OF THE AUTHORS OR COPYRIGHT HOLDERS

BE LIABLE FOR ANY DAMAGES CAUSED BY THE USE OR THE INABILITY TO

USE, OF THE FREETYPE PROJECT.

This license grants a worldwide, royalty-free, perpetual and irrevocable right and license to use, execute, perform, compile, display, copy, create derivative works of, distribute and sublicense the FreeType Project (in both source and object code forms) and derivative works thereof for any purpose; and to authorize others to exercise some or all of the rights granted herein, subject to the following conditions:

- o Redistribution of source code must retain this license file ('FTL.TXT') unaltered; any additions, deletions or changes to the original files must be clearly indicated in accompanying documentation. The copyright notices of the unaltered, original files must be preserved in all copies of source files.

- o Redistribution in binary form must provide a disclaimer that states that the software is based in part of the work of the FreeType Team, in the distribution documentation. We also encourage you to put an URL to the FreeType web page in your documentation, though this isn't mandatory.

These conditions apply to any software derived from or based on the FreeType Project, not just the unmodified files. If you use our work, you must acknowledge us. However, no fee need be paid to us.

Neither the FreeType authors and contributors

nor you shall use the name of the other for commercial, advertising, or promotional purposes without specific prior written permission.

We suggest, but do not require, that you use one or more of the following phrases to refer to this software in your documentation or advertising materials: 'FreeType Project', 'FreeType Engine', 'FreeType library', or 'FreeType Distribution'.

As you have not signed this license, you are not required to accept it. However, as the FreeType Project is copyrighted material, only this license, or another one contracted with the authors, grants you the right to use, distribute, and modify it. Therefore, by using, distributing, or modifying the FreeType Project, you indicate that you understand and accept all the terms of this license.

There are two mailing lists related to FreeType:

- o freetype@nongnu.org

Discusses general use and applications of FreeType, as well as future and wanted additions to the library and distribution.

If you are looking for support, start in this list if you

haven't found anything to help you in the documentation.

- o freetype-devel@nongnu.org

Discusses bugs, as well as engine internals, design issues, specific licenses, porting, etc.

Our home page can be found at

<http://www.freetype.org>

--- end of FTL.TXT ---

MOZILLA PUBLIC
LICENSE

Version 1.1

1.0.1. "Commercial Use" means distribution or otherwise making the Covered Code available to a third party.

1.1. "Contributor" means each entity that creates or contributes to the creation of Modifications.

1.2. "Contributor Version" means the combination of the Original Code, prior Modifications used by a Contributor, and the Modifications made by that particular Contributor.

1.3. "Covered Code" means the Original Code or Modifications or the combination of the Original Code and Modifications, in each case including portions thereof.

1.4. "Electronic Distribution Mechanism" means a mechanism generally accepted in the software development community for the electronic transfer of data.

1.5. "Executable" means Covered Code in any form other than Source Code.

1.6. "Initial Developer" means the individual or entity identified

as the Initial Developer in the Source Code notice required by Exhibit

A.

1.7. "Larger Work" means a work which combines Covered Code or

portions thereof with code not governed by the terms of this License.

1.8. "License" means this document.

1.8.1. "Licensable" means having the right to grant, to the maximum

extent possible, whether at the time of the initial grant or

subsequently acquired, any and all of the rights conveyed herein.

1.9. "Modifications" means any addition to or deletion from the

substance or structure of either the Original Code or any previous

Modifications. When Covered Code is released as a series of files, a

Modification is:

A. Any addition to or deletion from the contents of a file

containing Original Code or previous Modifications.

B. Any new file that contains any part of the Original Code or previous Modifications.

1.10. "Original Code" means Source Code of computer software code

which is described in the Source Code notice required by Exhibit A as

Original Code, and which, at the time of its release under this

License is not already Covered Code governed by this License.

1.10.1. "Patent Claims" means any patent

claim(s), now owned or

hereafter acquired, including without limitation, method, process,

and apparatus claims, in any patent Licensable by grantor.

1.11. "Source Code" means the preferred form of the Covered Code for

making modifications to it, including all modules it contains, plus

any associated interface definition files, scripts used to control

compilation and installation of an Executable, or source code

differential comparisons against either the Original Code or another

well known, available Covered Code of the Contributor's choice. The

Source Code can be in a compressed or archival form, provided the

appropriate decompression or de-archiving software is widely available

for no charge.

1.12. "You" (or "Your") means an individual or a legal entity

exercising rights under, and complying with all of the terms of, this

License or a future version of this License issued under Section 6.1.

For legal entities, "You" includes any entity which controls, is

controlled by, or is under common control with You. For purposes of

this definition, "control" means (a) the power, direct or indirect,

to cause the direction or management of such entity, whether by

contract or otherwise, or (b) ownership of more than fifty percent

(50%) of the outstanding shares or beneficial ownership of such

entity.

2.1. The Initial Developer Grant.

The Initial Developer hereby grants You a world-wide, royalty-free,

non-exclusive license, subject to third party

intellectual property

claims:

(a) under intellectual property rights (other than patent or

trademark) Licensable by Initial Developer to use, reproduce,

modify, display, perform, sublicense and distribute the Original

Code (or portions thereof) with or without Modifications, and/or

as part of a Larger Work; and

(b) under Patents Claims infringed by the making, using or

selling of Original Code, to make, have made, use, practice,

sell, and offer for sale, and/or otherwise dispose of the

Original Code (or portions thereof).

(c) the licenses granted in this Section 2.1(a) and (b) are

effective on the date Initial Developer first distributes

Original Code under the terms of this License.

(d) Notwithstanding Section 2.1(b) above, no patent license is

granted: 1) for code that You delete from the Original Code; 2)

separate from the Original Code; or 3) for infringements caused

by: i) the modification of the Original Code or ii) the

combination of the Original Code with other software or devices.

2.2. Contributor Grant.

Subject to third party intellectual property claims, each Contributor

hereby grants You a world-wide, royalty-free, non-exclusive license

(a) under intellectual property rights (other than patent or

trademark) Licensable by Contributor, to

use, reproduce, modify,

display, perform, sublicense and distribute the Modifications

created by such Contributor (or portions thereof) either on an

unmodified basis, with other Modifications, as Covered Code

and/or as part of a Larger Work; and

(b) under Patent Claims infringed by the making, using, or

selling of Modifications made by that Contributor either alone

and/or in combination with its Contributor Version (or portions

of such combination), to make, use, sell, offer for sale, have

made, and/or otherwise dispose of: 1) Modifications made by that

Contributor (or portions thereof); and 2) the combination of

Modifications made by that Contributor with its Contributor

Version (or portions of such combination).

(c) the licenses granted in Sections 2.2(a) and 2.2(b) are

effective on the date Contributor first makes Commercial Use of

the Covered Code.

(d) Notwithstanding Section 2.2(b) above, no patent license is

granted: 1) for any code that Contributor has deleted from the

Contributor Version; 2) separate from the Contributor Version;

3) for infringements caused by: i) third party modifications of

Contributor Version or ii) the combination of Modifications made

by that Contributor with other software (except as part of the

Contributor Version) or other devices; or 4) under Patent Claims

infringed by Covered Code in the absence of Modifications made by

that Contributor.

3.1. Application of License.

The Modifications which You create or to which You contribute are

governed by the terms of this License, including without limitation

Section 2.2. The Source Code version of Covered Code may be

distributed only under the terms of this License or a future version

of this License released under Section 6.1, and You must include a

copy of this License with every copy of the Source Code You

distribute. You may not offer or impose any terms on any Source Code

version that alters or restricts the applicable version of this

License or the recipients' rights hereunder. However, You may include

an additional document offering the additional rights described in

Section 3.5.

3.2. Availability of Source Code.

Any Modification which You create or to which You contribute must be

made available in Source Code form under the terms of this License

either on the same media as an Executable version or via an accepted

Electronic Distribution Mechanism to anyone to whom you made an

Executable version available; and if made available via Electronic

Distribution Mechanism, must remain available for at least twelve (12)

months after the date it initially became available, or at least six

(6) months after a subsequent version of that particular Modification

has been made available to such recipients. You are responsible for

ensuring that the Source Code version remains available even if the

Electronic Distribution Mechanism is maintained by a third party.

3.3. Description of Modifications.

You must cause all Covered Code to which You contribute to contain a

file documenting the changes You made to create that Covered Code and

the date of any change. You must include a prominent statement that

the Modification is derived, directly or indirectly, from Original

Code provided by the Initial Developer and including the name of the

Initial Developer in (a) the Source Code, and (b) in any notice in an

Executable version or related documentation in which You describe the

origin or ownership of the Covered Code.

3.4. Intellectual Property Matters

(a) Third Party Claims.

If Contributor has knowledge that a license under a third party's

intellectual property rights is required to exercise the rights

granted by such Contributor under Sections 2.1 or 2.2,

Contributor must include a text file with the Source Code

distribution titled "LEGAL" which describes the claim and the

party making the claim in sufficient detail that a recipient will

know whom to contact. If Contributor obtains such knowledge after

the Modification is made available as described in Section 3.2,

Contributor shall promptly modify the LEGAL file in all copies

Contributor makes available thereafter and shall take other steps

(such as notifying appropriate mailing lists or newsgroups)

reasonably calculated to inform those who received the Covered

Code that new knowledge has been obtained.

(b) Contributor APIs.

If Contributor's Modifications include an application programming

interface and Contributor has knowledge of patent licenses which

are reasonably necessary to implement that API, Contributor must

also include this information in the LEGAL file.

(c) Representations.

Contributor represents that, except as disclosed pursuant to

Section 3.4(a) above, Contributor believes that Contributor's

Modifications are Contributor's original creation(s) and/or

Contributor has sufficient rights to grant the rights conveyed by

this License.

3.5. Required Notices.

You must duplicate the notice in Exhibit A in each file of the Source

Code. If it is not possible to put such notice in a particular Source

Code file due to its structure, then You must include such notice in a

location (such as a relevant directory) where a user would be likely

to look for such a notice. If You created one or more Modification(s)

You may add your name as a Contributor to the notice described in

Exhibit A. You must also duplicate this License in any documentation

for the Source Code where You describe recipients' rights or ownership

rights relating to Covered Code. You may choose to offer, and to

charge a fee for, warranty, support, indemnity or liability

obligations to one or more recipients of Covered Code. However, You

may do so only on Your own behalf, and not on behalf of the Initial

Developer or any Contributor. You must make it absolutely clear than

any such warranty, support, indemnity or

liability obligation is

offered by You alone, and You hereby agree to indemnify the Initial

Developer and every Contributor for any liability incurred by the

Initial Developer or such Contributor as a result of warranty,

support, indemnity or liability terms You offer.

3.6. Distribution of Executable Versions.

You may distribute Covered Code in Executable form only if the

requirements of Section 3.1-3.5 have been met for that Covered Code,

and if You include a notice stating that the Source Code version of

the Covered Code is available under the terms of this License,

including a description of how and where You have fulfilled the

obligations of Section 3.2. The notice must be conspicuously included

in any notice in an Executable version, related documentation or

collateral in which You describe recipients' rights relating to the

Covered Code. You may distribute the Executable version of Covered

Code or ownership rights under a license of Your choice, which may

contain terms different from this License, provided that You are in

compliance with the terms of this License and that the license for the

Executable version does not attempt to limit or alter the recipient's

rights in the Source Code version from the rights set forth in this

License. If You distribute the Executable version under a different

license You must make it absolutely clear that any terms which differ

from this License are offered by You alone, not by the Initial

Developer or any Contributor. You hereby agree to indemnify the

Initial Developer and every Contributor for any liability incurred by

the Initial Developer or such Contributor as a result of any such

terms You offer.

3.7. Larger Works.

You may create a Larger Work by combining Covered Code with other code

not governed by the terms of this License and distribute the Larger

Work as a single product. In such a case, You must make sure the

requirements of this License are fulfilled for the Covered Code.

If it is impossible for You to comply with any of the terms of this

License with respect to some or all of the Covered Code due to

statute, judicial order, or regulation then You must: (a) comply with

the terms of this License to the maximum extent possible; and (b)

describe the limitations and the code they affect. Such description

must be included in the LEGAL file described in Section 3.4 and must

be included with all distributions of the Source Code. Except to the

extent prohibited by statute or regulation, such description must be

sufficiently detailed for a recipient of ordinary skill to be able to

understand it.

This License applies to code to which the Initial Developer has

attached the notice in Exhibit A and to related Covered Code.

6.1. New Versions.

Netscape Communications Corporation ("Netscape") may publish revised

and/or new versions of the License from time to time. Each version

will be given a distinguishing version number.

6.2. Effect of New Versions.

Once Covered Code has been published under a particular version of the

License, You may always continue to use it under the terms of that

version. You may also choose to use such Covered Code under the terms

of any subsequent version of the License published by Netscape. No one

other than Netscape has the right to modify the terms applicable to

Covered Code created under this License.

6.3. Derivative Works.

If You create or use a modified version of this License (which you may

only do in order to apply it to code which is not already Covered Code

governed by this License), You must (a) rename Your license so that

the phrases "Mozilla", "MOZILLAPL", "MOZPL", "Netscape",

"MPL", "NPL" or any confusingly similar phrase do not appear in your

license (except to note that your license differs from this License)

and (b) otherwise make it clear that Your version of the license

contains terms which differ from the Mozilla Public License and

Netscape Public License. (Filling in the name of the Initial

Developer, Original Code or Contributor in the notice described in

Exhibit A shall not of themselves be deemed to be modifications of

this License.)

COVERED CODE IS PROVIDED UNDER THIS LICENSE ON AN "AS IS" BASIS,

WITHOUT WARRANTY OF ANY KIND, EITHER EXPRESSED OR IMPLIED, INCLUDING,

WITHOUT LIMITATION, WARRANTIES THAT THE COVERED CODE IS FREE OF

DEFECTS, MERCHANTABILITY, FIT FOR A PARTICULAR PURPOSE OR NON-INFRINGEMENT.

THE ENTIRE RISK AS TO THE QUALITY AND PERFORMANCE OF THE COVERED CODE

IS WITH YOU. SHOULD ANY COVERED CODE

PROVE DEFECTIVE IN ANY RESPECT,

YOU (NOT THE INITIAL DEVELOPER OR ANY OTHER CONTRIBUTOR) ASSUME THE

COST OF ANY NECESSARY SERVICING, REPAIR OR CORRECTION. THIS DISCLAIMER

OF WARRANTY CONSTITUTES AN ESSENTIAL PART OF THIS LICENSE. NO USE OF

ANY COVERED CODE IS AUTHORIZED HEREUNDER EXCEPT UNDER THIS DISCLAIMER.

8.1. This License and the rights granted hereunder will terminate

automatically if You fail to comply with terms herein and fail to cure

such breach within 30 days of becoming aware of the breach. All

sublicenses to the Covered Code which are properly granted shall

survive any termination of this License. Provisions which, by their

nature, must remain in effect beyond the termination of this License

shall survive.

8.2. If You initiate litigation by asserting a patent infringement

claim (excluding declaratory judgment actions) against Initial Developer

or a Contributor (the Initial Developer or Contributor against whom

You file such action is referred to as "Participant") alleging that:

(a) such Participant's Contributor Version directly or indirectly

infringes any patent, then any and all rights granted by such

Participant to You under Sections 2.1 and/or 2.2 of this License

shall, upon 60 days notice from Participant terminate prospectively,

unless if within 60 days after receipt of notice You either: (i)

agree in writing to pay Participant a mutually agreeable reasonable

royalty for Your past and future use of Modifications made by such

Participant, or (ii) withdraw Your litigation claim

with respect to

the Contributor Version against such Participant. If within 60 days

of notice, a reasonable royalty and payment arrangement are not

mutually agreed upon in writing by the parties or the litigation claim

is not withdrawn, the rights granted by Participant to You under

Sections 2.1 and/or 2.2 automatically terminate at the expiration of

the 60 day notice period specified above.

(b) any software, hardware, or device, other than such Participant's

Contributor Version, directly or indirectly infringes any patent, then

any rights granted to You by such Participant under Sections 2.1(b)

and 2.2(b) are revoked effective as of the date You first made, used,

sold, distributed, or had made, Modifications made by that

Participant.

8.3. If You assert a patent infringement claim against Participant

alleging that such Participant's Contributor Version directly or

indirectly infringes any patent where such claim is resolved (such as

by license or settlement) prior to the initiation of patent

infringement litigation, then the reasonable value of the licenses

granted by such Participant under Sections 2.1 or 2.2 shall be taken

into account in determining the amount or value of any payment or

license.

8.4. In the event of termination under Sections 8.1 or 8.2 above,

all end user license agreements (excluding distributors and resellers)

which have been validly granted by You or any distributor hereunder

prior to termination shall survive termination.

UNDER NO CIRCUMSTANCES AND UNDER NO LEGAL THEORY, WHETHER TORT

(INCLUDING NEGLIGENCE), CONTRACT, OR OTHERWISE, SHALL YOU, THE INITIAL

DEVELOPER, ANY OTHER CONTRIBUTOR, OR ANY DISTRIBUTOR OF COVERED CODE,

OR ANY SUPPLIER OF ANY OF SUCH PARTIES, BE LIABLE TO ANY PERSON FOR

ANY INDIRECT, SPECIAL, INCIDENTAL, OR CONSEQUENTIAL DAMAGES OF ANY

CHARACTER INCLUDING, WITHOUT LIMITATION, DAMAGES FOR LOSS OF GOODWILL,

WORK STOPPAGE, COMPUTER FAILURE OR MALFUNCTION, OR ANY AND ALL OTHER

COMMERCIAL DAMAGES OR LOSSES, EVEN IF SUCH PARTY SHALL HAVE BEEN

INFORMED OF THE POSSIBILITY OF SUCH DAMAGES. THIS LIMITATION OF

LIABILITY SHALL NOT APPLY TO LIABILITY FOR DEATH OR PERSONAL INJURY

RESULTING FROM SUCH PARTY'S NEGLIGENCE TO THE EXTENT APPLICABLE LAW

PROHIBITS SUCH LIMITATION. SOME JURISDICTIONS DO NOT ALLOW THE

EXCLUSION OR LIMITATION OF INCIDENTAL OR CONSEQUENTIAL DAMAGES, SO

THIS EXCLUSION AND LIMITATION MAY NOT APPLY TO YOU.

The Covered Code is a "commercial item," as that term is defined in

48 C.F.R. 2.101 (Oct. 1995), consisting of "commercial computer

software" and "commercial computer software documentation," as such

terms are used in 48 C.F.R. 12.212 (Sept. 1995). Consistent with 48

C.F.R. 12.212 and 48 C.F.R. 227.7202-1 through 227.7202-4 (June 1995),

all U.S. Government End Users acquire Covered Code with only those

rights set forth herein.

This License represents the complete agreement concerning subject

matter hereof. If any provision of this License is held to be

unenforceable, such provision shall be reformed only to the extent

necessary to make it enforceable. This License shall be governed by

California law provisions (except to the extent applicable law, if

any, provides otherwise), excluding its conflict-of-law provisions.

With respect to disputes in which at least one party is a citizen of,

or an entity chartered or registered to do business in the United

States of America, any litigation relating to this License shall be

subject to the jurisdiction of the Federal Courts of the Northern

District of California, with venue lying in Santa Clara County,

California, with the losing party responsible for costs, including

without limitation, court costs and reasonable attorneys' fees and

expenses. The application of the United Nations Convention on

Contracts for the International Sale of Goods is expressly excluded.

Any law or regulation which provides that the language of a contract

shall be construed against the drafter shall not apply to this

License.

As between Initial Developer and the Contributors, each party is

responsible for claims and damages arising, directly or indirectly,

out of its utilization of rights under this License and You agree to

work with Initial Developer and Contributors to distribute such

responsibility on an equitable basis. Nothing herein is intended or

shall be deemed to constitute any admission of liability.

Initial Developer may designate portions of the Covered Code as

"Multiple-Licensed". "Multiple-Licensed"

means that the Initial

Developer permits you to utilize portions of the Covered Code under

Your choice of the NPL or the alternative licenses, if any, specified

by the Initial Developer in the file described in Exhibit A.

EXHIBIT A -Mozilla Public License.

"The contents of this file are subject to the Mozilla Public License

Version 1.1 (the "License"); you may not use this file except in

compliance with the License. You may obtain a copy of the License at

<http://www.mozilla.org/MPL/>

Software distributed under the License is distributed on an "AS IS"

basis, WITHOUT WARRANTY OF ANY KIND, either express or implied. See the

License for the specific language governing rights and limitations

under the License.

The Original Code is

The Initial Developer of the Original Code is

Portions created by _____ are Copyright (C) _____

----- All Rights Reserved.

Contributor(s):

Alternatively, the contents of this file may be used under the terms

of the _____ license (the "[_____] License"), in which case the

provisions of [_____] License are applicable instead of those

above. If you wish to allow use of your version of this file only

under the terms of the [_____] License and not to

allow others to use

your version of this file under the MPL, indicate your decision by

deleting the provisions above and replace them with the notice and

other provisions required by the [___] License. If you do not delete

the provisions above, a recipient may use your version of this file

under either the MPL or the [___] License."

[NOTE: The text of this Exhibit A may differ slightly from the text of

the notices in the Source Code files of the Original Code. You should

use the text of this Exhibit A rather than the text found in the

Original Code Source Code for Your Modifications.]

22.5

Obavijesti

Možete dobiti obavijest o dostupnosti novog softvera za televizor koji se može preuzeti ili o drugim temama u vezi sa softverom.

Čitanje obavijesti...

- 1 - Pritisnite , odaberite **Sve postavke** i pritisnite **OK**.
- 2 - Odaberite **Ažuriraj softver > Obavijesti**.
- 3 - Ako se prikaže obavijest, možete je pročitati ili odabrati jednu od dostupnih obavijesti.
- 4 - Po potrebi više puta pritisnite **◀** (lijevo) kako biste zatvorili izbornik.

Specifikacije

23.1

Zaštita okoliša

Specifikacije proizvoda

32PFS6402

- Razred energetske učinkovitosti: A
- Vidljiva veličina zaslona: 80 cm / 32 inča
- Potrošnja dok je napajanje uključeno (W): 34 W
- Godišnja potrošnja energije (kWh) *: 50 kWh
- Potrošnja energije u stanju pripravnosti (W) **: 0,30 W
- Rezolucija zaslona (pikseli): 1920 x 1080p

43PUS64x2

- Razred energetske učinkovitosti: A
- Vidljiva veličina zaslona: 108 cm / 43 inča
- Potrošnja dok je napajanje uključeno (W): 67 W
- Godišnja potrošnja energije (kWh) *: 98 kWh
- Potrošnja energije u stanju pripravnosti (W) **: 0,30 W
- Rezolucija zaslona (pikseli): 3840 x 2160p

49PUS64x2

- Razred energetske učinkovitosti: A
- Vidljiva veličina zaslona: 123 cm / 49 inča
- Potrošnja dok je napajanje uključeno (W): 87 W
- Godišnja potrošnja energije (kWh) *: 127 kWh
- Potrošnja energije u stanju pripravnosti (W) **: 0,30 W
- Rezolucija zaslona (pikseli): 3840 x 2160p

55PUS64x2

- Razred energetske učinkovitosti: A
- Vidljiva veličina zaslona: 139 cm / 55 inča
- Potrošnja dok je napajanje uključeno (W): 91 W
- Godišnja potrošnja energije (kWh) *: 133 kWh
- Potrošnja energije u stanju pripravnosti (W) **: 0,30 W
- Rezolucija zaslona (pikseli): 3840 x 2160p

* Godišnja potrošnja energije u kWh na temelju potrošnje televizora koji radi 4 sata dnevno 365 dana godišnje. Stvarna potrošnja energije ovisi o načinu na koji se televizor koristi.

** Kada se televizor isključi pomoću daljinskog upravljača i nijedna funkcija nije aktivna.

Kraj uporabe

Odlaganje starog proizvoda i baterija

Proizvod je proizveden od vrlo kvalitetnih materijala i komponenti, pogodnih za recikliranje i ponovnu uporabu.



Kada je na proizvod pričvršćen ovaj znak prekrizene kante za smeće, to znači da proizvod pokriva smjernica EU-a 2012/19/EU.



Upoznajte se s lokalnim sustavom odvojenog prikupljanja električnih i elektroničkih proizvoda.

Ponašajte se u skladu s lokalnim propisima i ne odlažite proizvode s uobičajenim kućanskim otpadom. Ispravno odlaganje starih proizvoda pomaže u sprječavanju potencijalnih negativnih posljedica za okoliš i ljudsko zdravlje.

Proizvod sadrži baterije koje su obuhvaćene direktivom EU-a 2006/66/EC koje se ne smiju odlagati s drugim kućanskim otpadom.



Saznajte koji su lokalni propisi o odvojenom prikupljanju baterija jer ispravno odlaganje pomaže u sprječavanju negativnih posljedica za okoliš i ljudsko zdravlje.

23.2

Snaga

Specifikacije proizvoda mogu se promijeniti bez prethodne najave. Više detalja za ovaj proizvod potražite na web-mjestu www.philips.com/support

Snaga

- Strujno napajanje: AC 220 - 240 V, +/-10 %.
- Temperatura okoline: 5 °C do 35 °C
- Značajke za uštedu energije: Ekološki način rada, isključenje zaslona (za radio), programiranje automatskog isključivanja, izbornik s ekološkim postavkama.

Informacije o potrošnji energije potražite u poglavlju Specifikacije proizvoda.

Oznaka napajanja navedena na pločici proizvoda

predstavlja potrošnju energije ovog proizvoda tijekom uobičajene uporabe u kućanstvu (IEC 62087 izdanje 2). Oznaka najvećeg napajanja, navedena u zagradama, predstavlja najvišu sigurnu vrijednost (IEC 60065 izdanje 7.2).

23.3

Operativni sustav

Android OS:

Android Lollipop 5.1

23.4

Prijem

- Antenski ulaz: 75 oma, koaksijalni (IEC75)
- Frekvencijski pojas prijemnika: Hyperband, S-Channel, UHF, VHF
- DVB: DVB-T2 (podrška za HEVC), DVB-C (kabelski) QAM
- Reprodukcijski analognog videozapisa: SECAM, PAL
- Reprodukcijski digitalnog videozapisa: MPEG2 SD/HD (ISO/IEC 13818-2), MPEG4 SD/HD (ISO/IEC 14496-10)
- Reprodukcijski digitalnog zvuka (ISO/IEC 13818-3)
- Ulaz za satelitsku antenu: 75 ohma, F
- Raspon ulaznih frekvencija: 950 do 2150MHz
- Raspon ulazne razine: 25 do 65 dBm
- DVB-S/S2 QPSK, brzina protoka 2 do 45 M simbola, SCPC i MCPC
- LNB: DiSEqC 1.0, podrška za 1 do 4 LNB uređaja, izbor polariteta 14/18 V, odabir pojasa 22 kHz, Tone burst način rada, LNB napon maks. 300 mA

23.5

Vrsta zaslona

Duljina dijagonale zaslona

- 32PFS6402 : 80 cm / 32 inča

Rezolucija zaslona

- 1920 x 1080p

23.6

Rezolucija zaslona

Videoformati

Rezolucija — brzina osvježavanja

- 480i – 60 Hz
- 480p – 60 Hz
- 576i – 50 Hz
- 576p – 50 Hz
- 720p – 50 Hz, 60 Hz
- 1080i – 50 Hz, 60 Hz

- 1080p – 24 Hz, 25 Hz, 30 Hz

Računalni formati

Rezolucije (među ostalima)

- 640 x 480p – 60 Hz
- 800 x 600p – 60 Hz
- 1024 x 768p – 60 Hz
- 1280 x 768p – 60 Hz
- 1360 x 765p – 60 Hz
- 1360 x 768p – 60 Hz
- 1280 x 1024p – 60 Hz
- 1920 x 1080p – 60 Hz

23.7

Dimenzije i mase

32PFS6402

- bez postolja televizora:

Širina 726,5 mm – visina 438,7 mm – dubina 76,8 mm – masa ± 5,63 kg

- s postoljem televizora:

Širina 726,5 mm – visina 483,3 mm – dubina 168,7 mm – masa ± 5,89 kg

43PUS64x2

- bez postolja televizora:

Širina 968,2 mm – visina 575,7 mm – dubina 76,8 mm – masa ± 9,38 kg

- s postoljem televizora:

Širina 968,2 mm – visina 623,3 mm – dubina 204,2 mm – masa ± 9,69 kg

49PUS64x2

- bez postolja televizora:

Širina 1099,2 mm – visina 645,3 mm – dubina 78,6 mm – masa ± 11,01 kg

- s postoljem televizora:

Širina 1099,2 mm – visina 699,7 mm – dubina 213,2 mm – težina ± 11,31 kg

55PUS64x2

- bez postolja televizora:

Širina 1239,2 mm – visina 724,7 mm – dubina 84,8 mm – masa ± 16 kg

- s postoljem televizora:

Širina 1239,2 mm – visina 779,5 mm – dubina 231,7 mm – masa ± 16,3 kg

23.8

Mogućnost povezivanja

Bočna strana televizora

- HDMI 3 – ARC
- HDMI 4 – MHL – ARC
- USB 2 – USB 3.0 (plava)
- USB 3 – USB 2.0
- 1 Common Interface utor: CI+/CAM
- Slušalice – stereo mini priključnica od 3,5 mm

Stražnja strana televizora

- Audio ulaz (DVI na HDMI) – stereo mini priključak od 3,5 mm
- SCART: Audio L/R, CVBS ulaz, RGB
- YPbPr: Y Pb Pr, Audio L/R

Donja strana televizora

- HDMI 1 ulaz
- HDMI 2 ulaz
- USB 1 – USB 2.0
- Audio izlaz – optički Toslink
- LAN mreža – RJ45
- Antena (75 oma)
- Satelitski tuner

- MPEG-4 AVC (H.264) je podržan do High Profile @ L5.1.
- H.265 (HEVC) je podržan do Main / Main 10 Profile, razina 5.1
- VC-1 je podržan do Advanced Profile @ L3.

Podržani softver multimedijskog poslužitelja (DMS)

- Možete koristiti bilo koji DLNA V1.5 certificirani softver medijskog poslužitelja (klasa DMS).
- Možete koristiti Philips TV Remote App (iOS i Android) na mobilnim uređajima.

Radne značajke se mogu razlikovati ovisno o značajkama mobilnog uređaja i softvera koji se koristi.

23.9

Zvuk

- wOOx
- HD Stereo
- Izlazna snaga (RMS): 16 W
- Dolby Digital Plus®
- DTS 2.0 + Digital out™

23.10

Multimedija

Priključnice

- USB 2.0 / USB 3.0
- Ethernet LAN RJ-45
- Wi-Fi 802.11a/b/g/n (ugrađeni)
- BT2.1 + EDR i BT4.0 + BLE

Podržani USB sustavi datoteka

- FAT 16, FAT 32, NTFS

Formati reprodukcije

- Datoteke: 3GP, AVCHD, AVI, MPEG-PS, MPEG-TS, MPEG-4, Matroska (MKV), Quicktime (MOV, M4V, M4A), Windows Media (ASF/WMV/WMA)
- Video kodek: MPEG-1, MPEG-2, MPEG-4 Part 2, MPEG-4 Part 10 AVC (H264), H.265 (HEVC), VC-1, WMV9
- Audio kodek: AAC, HE-AAC (v1/v2), AMR-NB, Dolby Digital, Dolby Digital Plus, DTS Premium Sound™, MPEG-1/2/2.5 Layer I/II/III (obuhvaća MP3), WMA (v2 to v9.2), WMA Pro (v9/v10)
- Titlovi:
 - Formati: SAMI, SubRip (SRT), SubViewer (SUB), MicroDVD (TXT), mplayer2 (TXT), TMLayer (TXT)
 - Kodiranje znakova: UTF-8, Srednja Europa i Istočna Europa (Windows-1250), ćirilica (Windows-1251), grčki (Windows-1253), turski (Windows-1254), Zapadna Europa (Windows-1252)
- Kodek za slike: JPEG, PNG, BMP
- Ograničenja:
 - Maksimalna podržana ukupna brzina za multimedijске datoteke je 30 Mb/s.
 - Maksimalna podržana brzina videozapisa za multimedijске datoteke je 20 Mb/s.

Pomoć i podrška

24.1

Registracija televizora

Registrirajte svoj televizor i uživajte u nizu prednosti, uključujući punu podršku (uz sadržaje za preuzimanje), privilegirani pristup informacijama o novim proizvodima, ekskluzivne ponude i popuste, šansu za osvajanje nagrada i čak sudjelovanje u posebnim anketama o novim izdanjima.

Idite na www.philips.com/welcome

24.2

Korištenje pomoći

Ovaj televizor nudi pomoć na zaslonu .

Otvaranje Pomoći

1 - Pritisnite  HOME.

2 - Odaberite Postavke > Pomoć > Korisnički priručnik.

Kako biste Pomoć čitali kao knjigu, odaberite **Knjiga**. Kako biste potražili ključnu riječ, odaberite **Ključna riječ**.

Također možete otvoriti  Pomoć u izborniku Početak ili izborniku televizora.

Prije izvršenja uputa u Pomoći, zatvorite Pomoć.

Za neke aktivnosti, kao što je Teletekst, tipke u boji imaju specifične funkcije i ne mogu otvoriti Pomoć.

Pomoć za televizor na tabletu, pametnom telefonu ili računalu

Kako biste lakše izvršili šire sljedove uputa, možete preuzeti Pomoć televizora u PDF formatu kako biste mogli čitati na pametnom telefonu, tabletu ili računalu. Umjesto toga, možete ispisati bitne stranice pomoći s računala.

Kako biste preuzeli Pomoć (korisnički priručnik), posjetite www.philips.com/support

24.3

Rješavanje problema

Uključivanje i daljinski upravljač

Televizor se ne uključuje

- Iskopčajte kabel za napajanje iz naponske utičnice. Pričekajte jednu minutu, a zatim ga ponovo ukopčajte.
- Provjerite je li kabel za napajanje čvrsto povezan.

Zvuk škripanja prilikom pokretanja ili isključivanja

Kada televizor uključujete, isključujete ili stavljate u stanje pripravnosti, čuje se škripanje kućišta. Škripanje je normalno i nastaje uslijed normalnog širenja i skupljanja televizora dok se hladi i zagrijava. To ne utječe na rad.

Televizor ne reagira na daljinski upravljač

Televizoru je potrebno neko vrijeme za pokretanje. U to vrijeme televizor ne reagira na daljinski upravljač ili kontrole na kućištu. To je normalno ponašanje. Ako televizor i dalje ne bude reagirao na daljinski upravljač, možete provjeriti radi li daljinski upravljač pomoću fotoaparata mobilnog telefona. Stavite telefon u način rada fotoaparata i usmjerite daljinski upravljač prema objektivu fotoaparata. Ako pritisnete bilo koju tipku na daljinskom upravljaču i primijetite infracrveno LED treperenje kroz objektiv fotoaparata, to znači da daljinski upravljač radi. Treba provjeriti televizor.

Ako ne primijetite treperenje, možda je daljinski upravljač pokvaren ili su baterije u njemu gotovo prazne.

Ova metoda provjere daljinskog upravljača nije moguća s daljinskim upravljačima koji se bežično uparuju s televizorom.

Televizor se vraća u stanje pripravnosti nakon što prikaže zaslon pokretanja s logotipom tvrtke Philips

Ako televizor iskopčate i ponovo ukopčate u izvor napajanja dok je u stanju pripravnosti, prikazat će se početni zaslon, a televizor će se vratiti u stanje pripravnosti. To je normalno ponašanje. Kako biste televizor ponovo aktivirali iz stanja pripravnosti, pritisnite  na daljinskom upravljaču ili televizoru.

Indikator stanja pripravnosti stalno bljeska

Iskopčajte kabel za napajanje iz naponske utičnice. Pričekajte 5 minuta prije ponovnog ukopčavanja kabela za napajanje. Ako se bljeskanje ponovo pojavi, obratite se korisničkoj službi tvrtke Philips.

Kanali

Tijekom instalacije nije pronađen nijedan digitalni kanal

Pogledajte tehničke specifikacije kako biste provjerili podržava li televizor DVB-T ili DVB-C u vašoj državi. Provjerite jesu li svi kabeli ispravno povezani i je li odabrana odgovarajuća mreža.

Prethodno instalirani kanali nisu na popisu kanala

Provjerite je li odabran odgovarajući popis kanala.

Slika

Nema slike / izobličena slika

- Provjerite je li antena ispravno povezana s televizorom.
- Provjerite je li odgovarajući uređaj odabran kao izvor prikaza.
- Provjerite je li vanjski uređaj ili izvor ispravno povezan.

Zvuk se čuje, ali nema slike

- Provjerite jesu li postavke slike ispravno postavljene.

Loš prijem antenskih signala

- Provjerite je li antena ispravno povezana s televizorom.
- Zvučnici, neuzemljeni audio uređaji, neonska svjetla, visoke zgrade i drugi veliki objekti utječu na kvalitetu prijema. Ako je moguće, pokušajte poboljšati kvalitetu prijema tako da promijenite smjer antene ili odmaknete uređaje od televizora.
- Ako je slab prijam samo jednog kanala, precizno ugodite taj kanal.

Loša slika s uređaja

- Provjerite je li uređaj ispravno povezan.
- Provjerite jesu li postavke slike ispravno postavljene.

Postavke slike mijenjaju se nakon određenog vremena

Provjerite je li opcija **Mjesto** postavljena na **Dom**. Postavke možete promijeniti i spremite u ovom načinu rada.

Prikazat će se reklamni natpis

Provjerite je li opcija **Mjesto** postavljena na **Dom**.

Slika ne odgovara zaslону

Promijenite format slike.

Format slike mijenja se sukladno raznim kanalima

Odaberite format slike koji nije "Automatski".

Položaj slike nije ispravan

Slika s nekih uređaja možda neće moći ispravno stati na zaslon. Provjerite izlazni signal s povezanog uređaja.

Slika s računala nije stabilna

Provjerite koristi li računalo podržanu rezoluciju i brzinu osvježavanja.

Zvuk

Nema zvuka ili loša kvaliteta zvuka

Ako ne otkrije nikakav audiosignal, televizor automatski isključuje audioizlaz – to ne ukazuje na kvar.

- Provjerite jesu li postavke zvuka ispravno postavljene.
 - Provjerite jesu li svi kabeli ispravno povezani.
 - Provjerite je li glasnoća isključena ili postavljena na nulu.
 - Provjerite je li audio izlaz televizora povezan s audio ulazom sustava kućnog kina. Zvuk bi se trebao čuti sa zvučnika sustava kućnog kina.
 - Neki uređaji možda će zahtijevati ručno omogućavanje HDMI audio izlaza. Ako je HDMI audio već omogućen, ali još uvijek ne čujete zvuk, pokušajte promijeniti digitalni audio format uređaja na PCM (Pulse Code Modulation). Upute potražite u dokumentaciji isporučenoj s uređajem.
-

HDMI i USB

HDMI

- Imajte na umu da podrška za HDCP (High-bandwidth Digital Content Protection) može produljiti vrijeme koje je televizoru potrebno da prikaže sadržaj s HDMI uređaja.
- Ako televizor ne prepoznaje HDMI uređaj i ne prikazuje se slika, postavite neki drugi pa ponovo vratiti ovaj izvor.
- Ako se čuje isprekidani zvuk, provjerite jesu li postavke izlaza s HDMI uređaja ispravne.
- Ako koristite HDMI-na-DVI adapter ili HDMI-na-DVI kabel, pazite da dodatni audio kabel bude priključen na AUDIO IN (samo minipriključak), ako je dostupan.

HDMI EasyLink ne radi

- Provjerite jesu li HDMI uređaji kompatibilni sa standardom HDMI-CEC. EasyLink značajke rade samo s uređajima koji podržavaju HDMI-CEC.

Ne prikazuje se ikona za glasnoću

- Kad je povezan HDMI-CEC audio uređaj i koristite daljinski upravljač televizora za promjenu glasnoće uređaja, takvo ponašanje je normalno.

Ne prikazuju se fotografije, videozapisi i glazba s USB uređaja

- Provjerite je li USB uređaj za pohranu postavljen na standard "Mass Storage Class" kako je opisano u dokumentaciji uređaja.
- Provjerite je li USB uređaj za pohranu kompatibilan s

televizorom.

- Provjerite podržava li televizor audiodatoteke i slikovne datoteke.

Isprekidana reprodukcija datoteka s USB uređaja

- Radne značajke prijenosa USB uređaja za pohranu mogu ograničavati brzinu prijenosa podataka na televizor, što dovodi do slabe reprodukcije.

Wi-Fi

Wi-Fi mreža nije pronađena ili u njoj postoje

smetnje

- Mikrovalne pećnice, DECT telefoni ili drugi Wi-Fi 802.11b/g/n uređaji u blizini mogu ometati bežičnu mrežu.
- Ako u relativnoj blizini televizora postoji puno bežičnih usmjerivača (npr. živite u stambenoj zgradi), preporučujemo odabir frekvencije usmjerivača od 5 GHz (802.11ac).
- Provjerite dopuštaju li vatrozidovi u mreži pristup bežičnoj vezi televizora.
- Kako biste osigurali jednostavnu instalaciju bežične mreže, nemojte skrivati naziv usmjerivača tako da isključite prikaz SSID-a.
- Ako bežična mreža u vašem domu ne radi ispravno, pokušajte koristiti žičanu mrežu.

Wi-Fi mrežna veza je spora

- Za uporabu usmjerivača potrebna je brza (širokopojasna) internetska veza.
- Ograničite broj uređaja koji koriste isti usmjerivač.
- U korisničkom priručniku za bežični usmjerivač potražite informacije o dometu u zatvorenom prostoru, brzini prijenosa i drugim čimbenicima kvalitete signala.

DHCP

- Ako uspostavljanje veze ne uspije, možete provjeriti DHCP (Dynamic Host Configuration Protocol) postavku usmjerivača. DHCP treba biti uključen.

Bluetooth

Uparivanje onemogućeno

- Provjerite je li uređaj u načinu za uparivanje. Pročitajte korisnički priručnik uređaja.
- Usmjerivač i bežični zvučnik držite što je bliže moguće televizoru.
- Velika količina bežične aktivnosti – stanovi s mnogim bežičnim usmjerivačima – može ograničiti bežičnu vezu.
- Pokušavate li upariti više uređaja s televizorom istovremeno, mogli biste naići na poteškoće.

Bluetooth je izgubio vezu

- Bežični zvučnik uvijek stavite na udaljenost manju od 5 metra od televizora.

Usklađivanje zvuka i slike Bluetooth uređaja

- Prije nego što kupite bežični Bluetooth zvučnik,

informirajte se o njegovoj kvaliteti usklađivanja zvuka i slike. Ne rade svi Bluetooth uređaji ispravno. Zatražite savjet od prodavača.





Internet

Internet ne radi

- Ako je veza s usmjerivačem ispravna, provjerite vezu usmjerivača s internetom.

Pogrešan jezik izbornika

Vratite jezik na onaj koji želite.

- 1 - Pritisnite .
- 2 - Odaberite ikonu  (postavke) i pritisnite **OK**.
- 3 - Pritisnite 5 puta  (dolje).
- 4 - Pritisnite 3 puta  (desno), odaberite svoj jezik i pritisnite **OK**.
- 5 - Pritisnite  BACK kako biste zatvorili izbornik.

24.4

Pomoć na mreži

Kako biste riješili bilo koji problem vezan uz televizor tvrtke Philips, možete se obratiti našoj podršci na mreži. Možete odabrati svoj jezik i unijeti broj modela svog proizvoda.

Posjetite www.philips.com/support.

Na web-stranici podrške možete pronaći telefonski broj u svojoj državi na koji nas možete kontaktirati, kao i odgovore na česta pitanja. U nekim državama možete putem mreže razgovarati s jednim od naših suradnika i postaviti pitanje izravno ili putem e-pošte. Možete preuzeti novi softver za televizor ili priručnik koji ćete čitati na računalu.

24.5

Podrška i popravak

Za podršku i popravak možete nazvati službu za podršku potrošačima u svojoj državi. Naši servisni inženjeri pobrinut će se za popravak ako je potreban.

Telefonski broj pronaći ćete u tiskanoj dokumentaciji isporučenoj s televizorom.

Prema potrebi, posjetite naše web-mjesto www.philips.com/support i odaberite državu.

Broj modela i serijski broj televizora

Od vas će se možda zatražiti da ostavite broj modela i serijski broj televizora. Te brojeve možete pronaći na naljepnici na ambalaži ili na naljepnici uređaja sa

stražnje strane ili na donjem dijelu televizora.

▲ Upozorenje

Ne pokušavajte popraviti televizor sami. To može dovesti do ozbiljne ozljede, nepopravljivog kvara televizora ili poništenja jamstva.

Sigurnost i održavanje

Sigurnost

Važno

Prije korištenja televizora s razumijevanjem pročitajte sve sigurnosne upute. Ako zbog nepridržavanja uputa dođe do oštećenja, jamstvo neće vrijediti.

Rizik od strujnog udara ili požara

- Televizor nikada ne izlažite kiši ili vodi. Posude s tekućinom, na primjer vaze, ne stavljajte blizu televizora. Ako se tekućina prolje po televizoru, odmah ga iskopčajte iz utičnice. Od korisničke podrške tvrtke Philips zatražite da prije uporabe provjeri televizor.
- Televizor, daljinski upravljač i baterije nemojte izlagati prekomjernoj toplini. Nikada ih nemojte stavljati blizu zapaljenih svijeća, otvorenog plamena ili drugih izvora topline, uključujući izravnu sunčevu svjetlost.
- Ne stavljajte predmete u ventilacijske i druge otvore na televizoru.
- Nikada nemojte stavljati teške predmete na kabel napajanja.
- Nemojte potezati utikače za napajanje. Olabavljeni utikači mogu uzrokovati iskrenje ili požar. Pazite da se kabel napajanja ne zateže prilikom zakretanja zaslona televizora.
- Kako biste iskopčali televizor, utikač za napajanje na televizoru mora se iskopčati. Prilikom iskopčavanja obavezno vucite utikač, a nikada kabel. Osigurajte potpun pristup utikaču, kabelu za napajanje i utičnici u svakom trenutku.

Rizik od ozljede ili oštećenja televizora

- Za podizanje i nošenje televizora težeg od 25 kg potrebne su dvije osobe.
- Ako televizor montirate na postolje, koristite samo isporučeno postolje. Postolje dobro pričvrstite za televizor. Postavite televizor na vodoravnu površinu koja može nositi težinu televizora i postolja.
- Prilikom montaže na zid koristite zidni nosač koji može nositi težinu televizora. Tvrtka TP Vision ne

snosi odgovornost za nepravilnu montažu na zid koja može uzrokovati nezgode, ozljede ili štetu.

- Dijelovi ovog proizvoda napravljeni su od stakla. Njima pažljivo rukujte kako biste izbjegli ozljede ili oštećenje.

Opasnost od oštećenja televizora!

Prije ukopčavanja televizora u zidnu utičnicu, provjerite odgovara li napon napajanja naponu navedenom na stražnjoj strani televizora. Nemojte ukopčavati televizor ako se napon razlikuje.

Rizik od ozljede djece

Kako biste spriječili prevrtanje televizora i ozljede djece, provedite ove mjere opreza:

- Nikada ne stavljajte televizor na površinu pokrivenu tkaninom ili drugim materijalom koji se može izvući.
- Pripazite da nijedan dio televizora ne visi iznad ruba površine.
- Televizor ne stavljajte na visoko pokućstvo (na primjer, police za knjige), a da i taj komad pokućstva i televizor ne pričvrstite za zid ili neki drugi odgovarajući potporanj.
- Upoznajte djecu s opasnostima koje im prijete ako se penju na pokućstvo kako bi dosegli televizor.

Opasnost od gutanja baterija!

U daljinskom upravljaču možda se nalaze okrugle baterije koje mala djeca lako mogu progutati. Te baterije uvijek držite izvan dohvata djece.

Rizik od pregrijavanja

Nikada nemojte postavljati televizor u skućeni prostor. Obavezno ostavite prostor od najmanje 10 cm oko televizora radi ventilacije. Pazite da zavjese ili drugi predmeti nikada ne prekrivaju otvore za ventilaciju televizora.

Grmljavinsko nevrijeme

Prije grmljavinskog nevremena iskopčajte televizor iz naponske utičnice i antenske priključnice. Tijekom grmljavinskog nevremena ne dirajte nijedan dio televizora, kabela za napajanje ili antenskog kabela.

Rizik od oštećenja sluha

Izbjegavajte korištenje slušalica pri velikoj glasnoći ili duže vremensko razdoblje.

Niske temperature

Ako se televizor transportira pri temperaturama nižima od 5°C, prije ukopčavanja u strujnu utičnicu raspakirajte televizor i pričekajte da se njegova temperatura izjednači sa sobnom temperaturom.

Vlažnost

U rijetkim slučajevima, ovisno o temperaturi i vlazi, s unutarnje strane prednje staklene ploče (kod nekih modela) televizora može se pojaviti kondenzacija. Kako biste to spriječili, televizor nemojte izlagati izravnoj sunčevoj svjetlosti, toplini niti visokoj razini vlage. Ako dođe do kondenzacije, ona će sama nestati nakon nekoliko sati rada televizora. Kondenzacija neće oštetiti televizor niti uzrokovati kvar.

25.2

Briga za zaslon

- Nikada nemojte dodirivati, gurati, trljati niti udarati zaslon nekim predmetom.
- Prije čišćenja isključite televizor iz naponske utičnice.
- Televizor i okvir čistite mekom, vlažnom krpom uz nježno brisanje. Nastojte ne dodirivati LED diode Ambilight osvjetljenja na stražnjoj strani televizora. Za čišćenje televizora nikada nemojte koristiti tvari kao što su alkohol, kemikalije ili sredstva za čišćenje kućanstva.
- Kako biste izbjegli deformacije i izbljeđivanje boje, kapi vode obrišite što je prije moguće.
- Izbjegavajte statične slike što je moguće više. Statične su slike one slike koje ostaju na zaslonu duže vremensko razdoblje. Statične slike uključuju zaslonske izbornike, crne trake, prikaze vremena itd. Ako morate koristiti statične slike, smanjite kontrast i svjetlinu kako biste izbjegli oštećenje zaslona.

Odredbe uporabe

26.1

Odredbe uporabe – televizor

2016 © TP Vision Europe B.V. Sva prava pridržana.

Ovaj je proizvod proizvela i plasirala na tržište tvrtka TP Vision Europe B.V. ili neka od njezinih podružnica – u nastavku ovog dokumenta "TP Vision". TP Vision daje jamstvo za televizor uz koji je bila priložena ova knjižica. Philips i Philipsov emblem registrirani su zaštitni znakovi tvrtke Koninklijke Philips N.V.

Specifikacije se mogu promijeniti bez prethodne obavijesti. Zaštitni znakovi vlasništvo su tvrtke Koninklijke Philips N.V ili odgovarajućih vlasnika. TP Vision zadržava pravo izmjene proizvoda u bilo koje vrijeme bez obveze prilagodbe ranijih isporuka u skladu s time.

Smatra se da je pisani materijal koji se isporučuje s televizorom i priručnik pohranjen u memoriji televizora ili preuzet s web-mjesta tvrtke Philips www.philips.com/support pogodan za predviđenu namjenu sustava.

Materijal u ovom priručniku smatra se odgovarajućim za namijenjenu uporabu sustava. Ako se proizvod ili njegovi pojedini moduli i postupci koriste za svrhe koje ovdje nisu navedene, potrebno je zatražiti potvrdu njihove valjanosti i prikladnosti. TP Vision jamči da sam materijal ne krši prava nijednog patenta registriranog u Sjedinjenim Američkim Državama. Nema nikakvog drugo izričitog ili impliciranog jamstva. TP Vision nije odgovoran ni za kakve pogreške u sadržaju ovog dokumenta ni za eventualne probleme nastale kao posljedica sadržaja navedenog u njemu. Pogreške koje se prijave tvrtki Philips ispraviti će se i objaviti na web-mjestu podrške tvrtke Philips što je moguće prije.

Odredbe jamstva – Rizik od ozljede, oštećenja televizora ili poništenja jamstva!
Nikada nemojte sami pokušavati popraviti televizor. Koristite televizor i dodatnu opremu samo onako kako propisuje proizvođač. Znak opreza otisnut na stražnjoj strani televizora ukazuje na rizik od strujnog udara. Nikada nemojte skidati poklopac televizora. Ako trebate servis ili popravak, obavezno kontaktirajte službu za korisnike tvrtke Philips. Telefonski broj pronaći ćete u tiskanoj dokumentaciji isporučenoj s televizorom. Prema potrebi, posjetite naše web-mjesto www.philips.com/support i odaberite državu. Svi postupci izričito zabranjeni u ovom priručniku i sve prilagodbe ili preinake koje nisu preporučene ili odobrene u ovom priručniku automatski poništavaju jamstvo.

Karakteristike piksela

Ovaj LCD/LED uređaj ima velik broj piksela u boji. Iako ima najmanje 99,999 % funkcionalnih piksela, na zaslonu se stalno mogu pojavljivati crne ili svijetle točke (crvene, zelene, plave). To je strukturno svojstvo zaslona (unutar okvira uobičajenih industrijskih standarda), a ne kvar.

CE sukladnost

Ovim putem tvrtka TP Vision Europe B.V. izjavljuje da je ovaj televizor sukladan osnovnim zahtjevima i drugim primjenjivim odredbama Direktiva 2014/53/EU (RED), 2009/125/EC (ekološki dizajn), 2010/30/EU (energetske oznake) i 2011/65/EC (RoHS).

Sukladnost EMF standardima

TP Vision proizvodi i prodaje mnoge potrošačke proizvode koji, poput svih elektroničkih uređaja, općenito mogu odašiljati i primati elektromagnetske signale. Jedno je od glavnih poslovnih načela tvrtke TP Vision poduzeti sve moguće zdravstvene i sigurnosne mjere pri uporabi naših proizvoda, poštivati sve mjerodavne pravne propise i pridržavati se svih EMF standarda koji su na snazi u vrijeme proizvodnje uređaja.

Tvrtka TP Vision razvija, proizvodi i prodaje samo uređaje koji ne izazivaju posljedice štetne po zdravlje. Tvrtka TP Vision jamči da su njezini proizvodi, prema danas dostupnim znanstvenim istraživanjima, sigurni ako se koriste na pravilan način i u predviđene svrhe. Tvrtka TP Vision aktivno sudjeluje u razvoju međunarodnih EMF i sigurnosnih standarda, što nam omogućuje da predvidimo razvoj novih standarda i odmah ih integriramo u svoje proizvode.

26.2

Odredbe uporabe – Galerija aplikacija

Kako biste pronašli više informacija, u izborniku **Pomoć** odaberite **Ključne riječi** i potražite **Odredbe uporabe**, **Galerija aplikacija**.

Autorska prava

27.1

MHL

MHL, Mobile High-Definition Link i logotip MHL zaštitni su znakovi ili registrirani zaštitni znakovi tvrtke MHL, LLC.



27.2

HDMI

Pojmovi HDMI i HDMI High-Definition Multimedia Interface, kao i HDMI logotip zaštićeni su znakovi ili registrirani zaštićeni znakovi tvrtke HDMI Licensing LLC u Sjedinjenim Državama i drugim državama.



27.3

Dolby Audio

Proizvedeno uz licencu tvrtke Dolby Laboratories. Dolby, Dolby Audio i simbol dvostrukog slova D zaštitni su znakovi Dolby Laboratories.



27.4

DTS 2.0+Digital Out™

Za DTS patente pogledajte <http://patents.dts.com>. Proizvedeno pod licencom tvrtke DTS Licensing Limited. DTS, simbol i DTS u kombinaciji sa simbolom registrirani su zaštitni znakovi, a DTS 2.0+Digital Out zaštitni je znak tvrtke DTS, Inc. © DTS, Inc. Sva prava pridržana.



27.5

Microsoft

Windows Media

Windows Media registrirani je zaštitni znak ili zaštitni znak tvrtke Microsoft Corporation u Sjedinjenim Državama i/ili drugim državama.



Microsoft PlayReady

Vlasnici sadržaja koriste Microsoft PlayReady™ tehnologiju za pristup sadržaju kako bi zaštitili svoje intelektualno vlasništvo, što obuhvaća i sadržaj zaštićen autorskim pravom. Ovaj uređaj koristi tehnologiju PlayReady za pristup sadržaju s PlayReady i/ili WMDRM zaštitom. Ako uređaj ne uspije ispravno provesti ograničenje korištenja sadržaja, vlasnici sadržaja mogu zatražiti od tvrtke Microsoft opoziv mogućnosti uređaja da pristupa sadržaju s PlayReady zaštitom. Opoziv ne bi trebao utjecati na nezaštićeni sadržaj ili sadržaj zaštićen drugim tehnologijama za pristup sadržaju. Vlasnici sadržaja mogu zatražiti od vas da nadogradite PlayReady kako biste pristupili njihovom sadržaju. Ako odbijete nadogradnju, nećete moći pristupiti sadržaju koji zahtijeva nadogradnju.

27.6

Wi-Fi Alliance

Wi-Fi®, logotip Wi-Fi CERTIFIED, logotip Wi-Fi registrirani su zaštitni znakovi udruženja Wi-Fi Alliance.



Kensington

(ako je primjenjivo)

Kensington i Micro Saver zaštitni su znakovi tvrtke ACCO World Corporation registrirani u Sjedinjenim Američkim Državama, dok je u više država diljem svijeta postupak registracije u tijeku.



Drugi zaštitni znakovi

Svi ostali registrirani ili neregistrirani zaštitni znakovi pripadaju odgovarajućim vlasnicima.

Izjava o odricanju od odgovornosti za usluge i/ili softver trećih strana

Usluge i/ili softver trećih strana mogu se promijeniti, obustaviti ili ukinuti bez prethodne najave. TP Vision ne preuzima nikakvu odgovornost u takvim situacijama.

Indeks

A

Ambilight, postavke 54
Antenski priključak 7
Aplikacija, glasovno pretraživanje 9
Aplikacije 40
Audioopis 63
Automatsko isključivanje 62
Automatsko izjednačavanje glasnoće 53
Ažuriraj softver 80

B

Bas 52
Baterije, daljinski upravljač 10
Bežična mreža 34
Bluetooth 28
Bluetooth, odabir uređaja 29
Bluetooth, uklanjanje uređaja 29
Bluetooth, uparivanje 28
Boja 48
Briga za zaslon 209
Brzo postavljanje slike 52

C

CAM moduli za satelitske kanale 12

D

Daljinski upravljač, IC senzor 10
Daljinski upravljač, pregled 8
DMR, Digital Media Renderer 36

E

EasyLink 25
Ekološke postavke 57

F

Format slike 51
Fotoaparati, povezivanje 32
Fotografije, videozapisi i glazba 65

G

Gama 50
Glasnoća slušalica 52
Glasovno pretraživanje, aplikacija 9
Gledanje televizije 18

H

HDMI MHL 24
HDMI, ARC 24
HDMI-DVI povezivanje 25

I

Igrača konzola, povezivanje 29
Instalacija mreže 34
Instalacija satelita 12
Internetska memorija, brisanje 35
Isključivanje 11
Izbornik Početak 38

K

Kamkorder, povezivanje 32
Kanal 17
Kanal, instalacija satelitskih 12
Kanal, klasifikacija prema dobnoj skupini 19
Kanal, popis kanala, filtriranje 18

Kanal, popis kanala, otvaranje 18
Kanal, popis kanala, pretraživanje 18
Kanal, popis kanala, više informacija 17
Kanal, prelazak na kanal 18
Klasifikacija prema dobnoj skupini 19
Kontrast 49
Kontrast, dinamički kontrast 50
Kontrast, kontrast videozapisa 50
Kopiranje popisa kanala 17
Kopiranje popisa kanala, kopiranje 17
Kopiranje popisa kanala, prijenos 17
Kopiranje popisa kanala, trenutna verzija 17
Kraj uporabe 201

L

Logotip Philips, svjetlina 58

M

Mjerač vremena za isključivanje 57
MPEG smanjenje smetnji 51
Mreža, bežično 34
Mreža, Očisti internetsku memoriju 36
Mreža, postavke 35
Mreža, povezivanje 34
Mreža, prikaz postavki 35
Mreža, uključivanje Wi-Fi veze 36
Mreža, Wi-Fi Smart Screen 36
Mreža, WPS 34
Mreža, žična 35
Mreža, WPS s PIN kodom 34
Mreže, statički IP 35
Mreže, WoWLAN 35
Mrežni naziv televizora 36
Multi View 79
Multimedijske datoteke, s pohrane u oblaku 65
Multimedijske datoteke, s računala ili NAS uređaja 65
Multimedijske datoteke, s USB pogona 65

N

Naglašavanje boje 49
Napajanje 6
Način rada kontrasta 50

O

Obavijesti 200
Odabir videozapisa 20
Odlaganje televizora ili baterija 201
Odredbe uporabe 210
Odredbe uporabe, galerija aplikacija 37
Osobe oštećena sluha 62
Osobe oštećena sluha 62
Osobe slabijeg vida 62
Oštrina 49

P

Pause TV 71
Podaci TV vodiča 68
Podrška na mreži 206
Postavke za Android 37
Prilagodena temperatura boje 50
Problem, HDMI priključak 205
Problem, USB priključak 205
Problemi, daljinski upravljač 204

Problemi, jezik izbornika 206
Problemi, slika 205
Problemi, zvuk 205
Programi, preporuke 76

R

Računalo, povezivanje 33
Roditeljski nadzor 19

S

Sada na TV-u 76
Satelit, dodavanje satelita 13
Satelit, paketi kanala 12
Satelit, ručno ažuriranje kanala 13
Satelit, uklanjanje satelita 13
Satelit, Unicable 13
Satelitski, ručna instalacija 14
Satelitsko povezivanje 7
Sigurnosne upute 208
Slušalice, povezivanje 29
Služba za potrošače 206
Smanjenje šuma 51
Smještaj, smještaj televizora 6
Smještaj, udaljenost za gledanje 6
Stanje pripravnosti 11
Stil slike 48
Stil zvuka 52
Super Resolution 50
Svjetlina 49

T

Teletext 22
Temperatura boja 49
Trgovina Google Play 41
TV na zahtjev 76

U

Uključivanje 11
Unicable 13
Univerzalni pristup 62
Upravljač za igranje, povezivanje 30
USB Flash pogon 32
USB tipkovnica 31
USB tvrdi disk, instalacija 30

V

Video na zahtjev 77
Visoki tonovi 52
Vodič za mogućnost povezivanja 24

W

Wi-Fi 34

Y

YPbPr veza, savjeti 25

Z

Za osobe slabijeg vida 63
Zaključavanje aplikacije 41
Zvuk, automatsko izjednačavanje glasnoće 53

Ž

Žična mreža 35



All registered and unregistered trademarks are property of their respective owners.
Specifications are subject to change without notice.
Philips and the Philips' shield emblem are trademarks of Koninklijke Philips N.V.
and are used under license from Koninklijke Philips N.V.
2017 © TP Vision Europe B.V. All rights reserved.

philips.com