

Table of contents

1	Important	3	7	Connections (DVD, receiver, ...)	37
1.1	Safety	3	7.1	Connections overview	37
1.2	Care of the screen	3	7.2	About connecting	38
1.3	Recycling	3	7.3	Connect your devices	40
			7.4	Connections setup	44
			7.5	Preparing for digital services	45
2	Your TV	4	8	Technical data	46
2.1	Television overview	4	9	Troubleshooting	47
2.2	Product highlights	5	10	Index	49
3	Getting started	5			
3.1	Position the TV	5			
3.2	Wall mounting - VESA	5			
3.3	Remote control batteries	9			
3.4	Antenna cable	9			
3.5	Connect the mains	9			
3.6	First time installation	97			
4	Use your TV	10			
4.1	Switch on or off - Standby	10			
4.2	Watch TV	11			
4.3	Watch channels from a digital receiver	11			
4.4	Watch connected devices	11			
4.5	Watch a DVD	12			
4.6	Select a Teletext page	12			
4.7	Change Ambilight mode	13			
5	Use more of your TV	14			
5.1	Remote Control	14			
5.2	TV menu overview	17			
5.3	Picture and sound settings	19			
5.4	Ambilight	23			
5.5	Teletext	23			
5.6	Create favourite channel lists	25			
5.7	Electronic Programme Guide	26			
5.8	Timers and locks	27			
5.9	Subtitles	28			
5.10	View and play photos, MP3...	29			
5.11	Listen to digital radio channels	31			
5.12	Software update	31			
6	Channel installation	34			
6.1	Automatic channel installation	34			
6.2	Manual channel installation	35			
6.3	Rearrange stored channels	35			
6.4	Automatic channel management	36			
6.5	Digital reception test	36			
6.6	Factory settings	36			

Register your product and get support at
www.philips.com/welcome.

2007 © Koninklijke Philips Electronics N.V. All rights reserved. Specifications are subject to change without notice. Trademarks are the property of Koninklijke Philips Electronics N.V. or their respective owners.

Philips reserves the right to change products at any time without being obliged to adjust earlier supplies accordingly.

The material in this manual is believed adequate for the intended use of the system. If the product, or its individual modules or procedures, are used for purposes other than those specified herein, confirmation of their validity and suitability must be obtained. Philips warrants that the material itself does not infringe any United States patents. No further warranty is expressed or implied.

Warranty

No components are user-serviceable. Do not open or remove covers to the inside of the product. Repairs may only be done by Philips Service Centres and official repairshops. Failure to do so shall void any warranty, stated or implied. Any operation expressly prohibited in this manual, any adjustments, or assembly procedures not recommended or authorised in this manual shall void the warranty.

Pixel characteristics

This LCD product has a high number of colour pixels. Although it has effective pixels of 99,999% or more, black dots or bright points of light (red, green or blue) may appear constantly on the screen. This is a structural property of the display (within common industry standards) and is not a malfunction.

Open source software

This television contains open source software. Philips hereby offers to deliver or make available, upon request, for a charge no more than the cost of physically performing source distribution, a complete machine-readable copy of the corresponding source code on a medium customarily used for software interchange.

This offer is valid for a period of 3 years after the date of purchase of this product. To obtain the source code, write to

Philips Innovative Applications N.V.
Ass. to the Development Manager
Pathoekeweg 11
B-8000 Brugge
Belgium

Compliance with EMF

Koninklijke Philips Electronics N.V. manufactures and sells many products targeted at consumers, which, like any electronic apparatus, in general have the ability to emit and receive electromagnetic signals.

One of Philips' leading Business Principles is to take all necessary health and safety measures for our products, to comply with all applicable legal requirements and to stay well within the EMF standards applicable at the time of producing the products.

Philips is committed to develop, produce and market products that cause no adverse health effects.

Philips confirms that if its products are handled properly for their intended use, they are safe to use according to scientific evidence available today.

Philips plays an active role in the development of international EMF and safety standards, enabling Philips to anticipate further developments in standardisation for early integration in its products.

Mains fuse (UK only)

This TV is fitted with an approved moulded plug. Should it become necessary to replace the mains fuse, this must be replaced with a fuse of the **same value as indicated** on the plug (example **10A**).

1. Remove fuse cover and fuse.
2. The replacement fuse must comply with BS 1362 and have the ASTA approval mark. If the fuse is lost, contact your dealer in order to verify the correct type.
3. Refit the fuse cover.

In order to maintain conformity to the EMC directive, the mains plug on this product must not be detached from the mains cord.

Copyrights



VESA, FDMI and the VESA Mounting Compliant logo are trademarks of the Video Electronics Standards Association.



Manufactured under license from Dolby Laboratories. 'Dolby', 'Pro Logic' and the double D symbol , are trademarks of Dolby Laboratories.



Manufactured under license from BBE Sound, Inc. Licensed by BBE, Inc under one or more of the following US patents: 5510752, 5736897. BBE and BBE symbol are registered trademarks of BBE Sound Inc.

Windows Media is either a registered trademark or trademark of Microsoft Corporation in the United States and/or other countries

® Kensington and MicroSaver are registered US trademarks of ACCO World Corporation with issued registrations and pending applications in other countries throughout the world. All other registered and unregistered trademarks are the property of their respective owners.

1 Important

Read this user manual before you start to use this product.

Pay attention to this section and closely follow the instructions. The warranty does not apply to damage caused by not taking into account the instructions.

1.1 Safety

- To avoid short circuit, do not expose the product to rain or water.
- To avoid a risk of fire or electric shock do not place naked flame sources (e.g. lighted candles) close to the TV.
- Leave a space of at least 10cm (4 inches) all around the TV for ventilation.
- Keep away from radiators or other heat sources.
- Do not install the TV in a confined space such as a book case. Make sure that curtains, cupboards and so on cannot obstruct the air flow through the ventilation slots.
- Make sure the TV can not fall down. Place the TV on a solid and flat surface and only use the stand provided with the TV.
- To prevent damaging the mains cord which may cause a fire or electric shock, do not place the TV on the cord or anything else that can pinch the cord.
- When mounted on a swivel stand or VESA wall bracket avoid force coming on the mains plugs. Partly loosened mains plugs can cause arcing or fire.

1.2 Care of the screen

- Unplug the TV before cleaning.
- Clean the surface with a soft damp cloth. Do not apply any other substance (chemical or household cleaning agent). This may damage the screen.
- Do not touch, push or rub or strike the screen with anything hard as this may scratch, mar or damage the screen permanently.
- To avoid deformations and colour fading, wipe off water drops as soon as possible.

- Stationary images
Avoid stationary images as much as possible. If you can not, reduce screen contrast and brightness to prevent damage to the screen. Stationary images are images that remain on the screen for a long time. Examples of stationary images are: on screen menus, teletext pages, black bars, stock market information, TV channel logos, time displays, and so on.

1.3 Recycling

- Take the packaging to your local recycling centre.
- Dispose old batteries safely according local regulations.
- This product is designed and manufactured for material recycling and re-use.
- This product should not be disposed with other household waste. Inform yourself or ask your dealer about local environmentally safe recycling and local regulations. Uncontrolled waste disposal harms the environment and human health. (EEC 2002/96/EC)



2 Your TV

This section gives you an overview of the controls and functions of this TV.

2.1 Television overview

Side controls

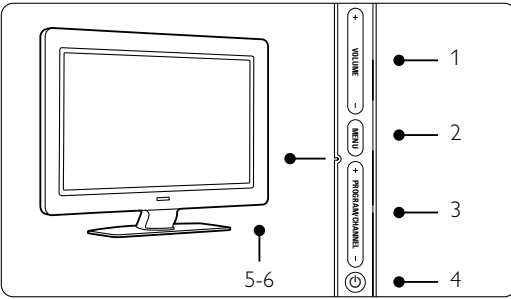

- 1 Volume up and down
- 2 Menu
- 3 Program or Channel up and down
- 4 Power switch
- 5 Led indicator (Blue: On; Red: Standby)
- 6 Remote control sensor

Side connectors

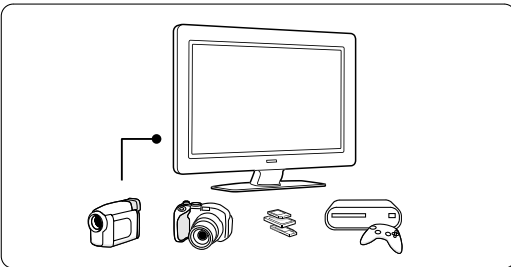

To connect a camera, game console, headphone or a USB memory device.

Back connectors

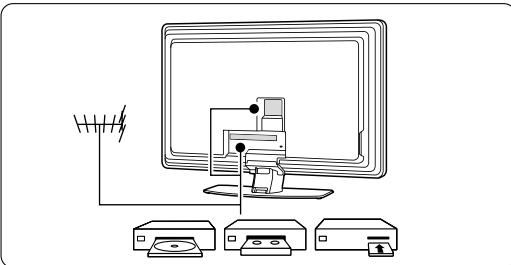

To connect the antenna, DVD, VCR or other device.

Remote control

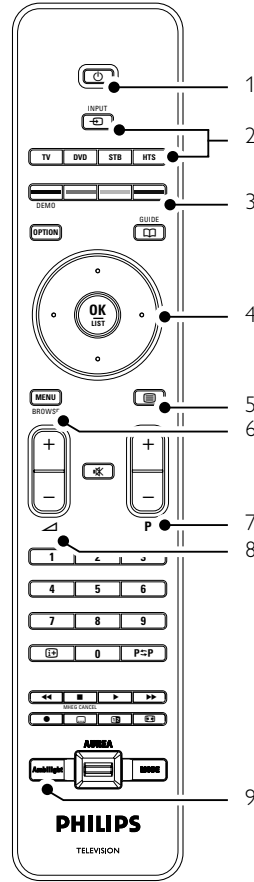

- 1 Standby or On
- 2 DVD, STB, ... device selection
- 3 Colour keys
- 4 Navigation key (up, down, left, right) OK
- 5 Teletext key
- 6 Menu key
- 7 Programme up or down
- 8 Volume up or down
- 9 Ambilight on or off

Find more on your remote control in section 5.1 **Remote control overview.**

2.2 Product highlights

Your new TV is equipped with some of the most modern audio or video innovations. Your TV offers the following advantages ...

Full High Definition LCD display

A full HD resolution of 1920x1080p, the highest resolution of HD sources. It offers a brilliant flicker-free progressive scan picture with optimum brightness and superb colours.

Ambilight

For a more relaxed viewing experience and improved perceived picture quality.

Perfect Pixel HD

Offers perfect picture quality from any source.

100Hz Clear LCD

100Hz Clear LCD results in superior sharpness of motion reproduction, better black level, high contrast with a flicker-free, quiet image and a larger viewing angle.

DVB-T integrated tuner

Next to normal analogue TV broadcast your TV receives digital terrestrial TV and radio broadcasts.

Electronic Programme Guide - EPG

The EPG shows the scheduled digital TV programmes on screen. The guide can remind you when programmes start, switch the TV on, etc.

HDMI connectors

3 HDMI connectors for highest quality high definition connectivity.

USB connection

Multimedia connection for instantly view or play your photos or music.

3 Getting started

This section helps you with the positioning and the first time installation of the TV.

3.1 Position the TV

⚠ Warning

Carefully read the safety precautions in section 1.1 Safety before you position the TV.

Large screen TVs are heavy. Carry and handle the TV with at least two persons.

Connect your devices first before you position your TV or mount it on the wall.

The ideal viewing distance for watching TV is three times its diagonal screensize.

For ideal viewing conditions, position the TV where light does not fall directly on the screen.

Best Ambilight effect is watched in a room with dimmed lighting conditions.

For the best Ambilight effect, position the TV 10 to 20 cm away from the wall. Position the TV where sunlight does not fall directly on the TV.

Kensington Security Slot

Your TV is equipped with a Kensington Security Slot at the back of the TV for an anti-theft lock. An anti-theft Kensington lock has to be purchased separately.

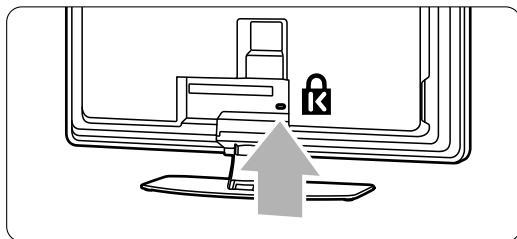

3.2 Wall mounting

You can wall mount the TV with the supplied wall mount bracket.

3.2.1 Unmounting the TV stand

The TV stand should be unmounted from the TV to allow the TV to be wall mounted.

- 1 Unscrew the 4 screws that secure the stand to the TV.

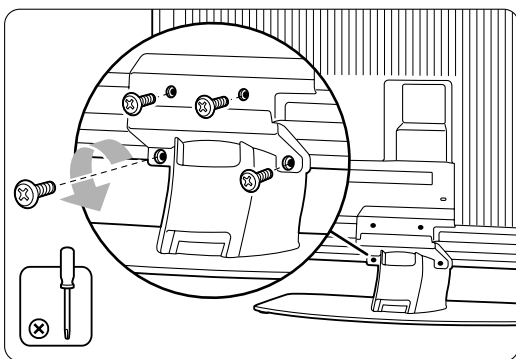

- 2 Lift the TV from the stand.

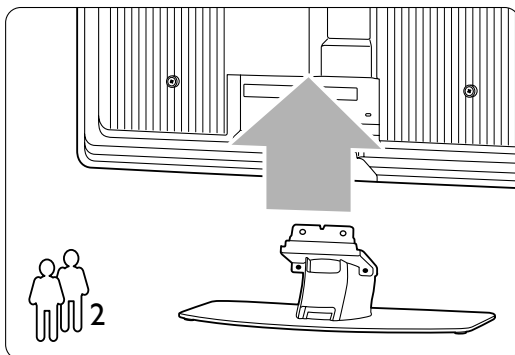

3.2.2 Mounting the wall mount bracket

⚠ Caution

Wall mounting the TV requires special skills that should only be performed by qualified personnel. Wall mounting the TV should meet safety standards according to the TV's weight.

Koninklijke Philips Electronics N.V. bears no responsibility for improper mounting or mounting that results in accident or injury.

Read also the safety precautions in section 1.1 Safety before you position the TV.

- 1 Collect the parts for wall mounting.

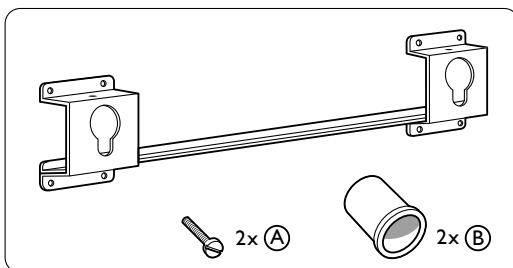

- 2 Insert just a little bit both security screws in the wall mount bracket.

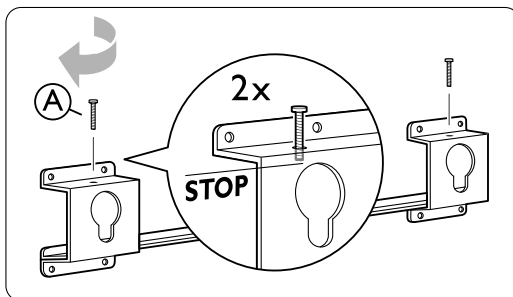

- 3 Verify the presence of the 4 plastic discs at the back of the TV.

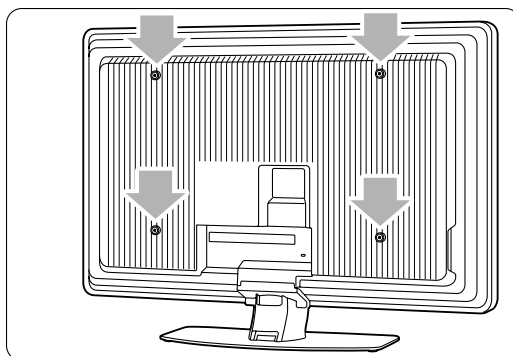

- 4** Mount the 2 spacers **(B)** on the 2 lower discs at the back of the TV.

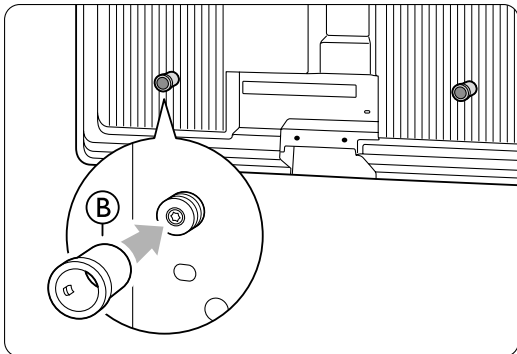

- 5** Calculate your TV's ideal position.

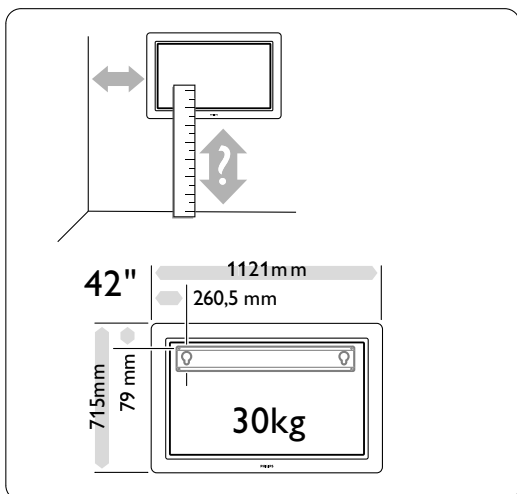

- 6** Position and level the wall mount bracket and fix the bracket firmly to the wall.

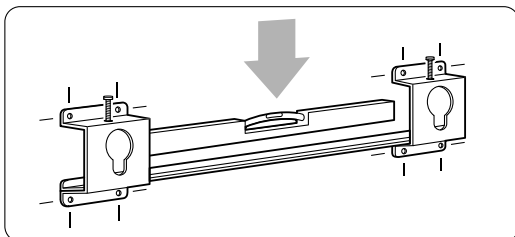

- 7** Connect all cables.
See section **7 Connections**.

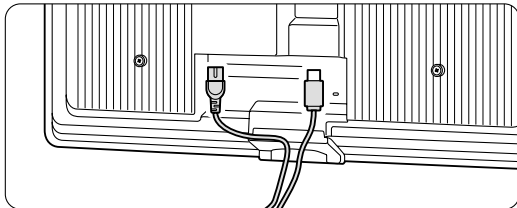

- 8** Lift the TV into the wall mount bracket.

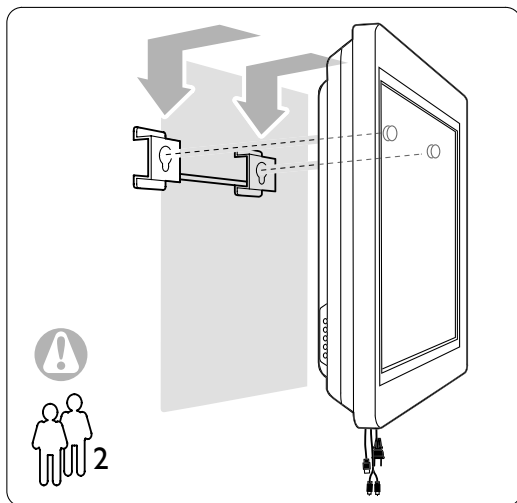

- 9** Secure the TV in the bracket by screwing in the 2 already fitted screws **(A)**.

3.2.3 VESA compliant mounting

⚠ Caution

Use a VESA compliant bracket that meets safety standards according to the TV's weight. Closely follow the instructions that come with your VESA compliant bracket to mount the TV.

Koninklijke Philips Electronics N.V. bears no responsibility for improper mounting or mounting that results in accident or injury.

The TV is prepared for VESA compliant mounting. This bracket is not included.

Use a VESA compliant bracket with code **VESA MIS-F, 600, 400, 8.**

Prepare the TV for VESA compliant mounting.

- 1** Locate the VESA screwholes on the back of the TV.

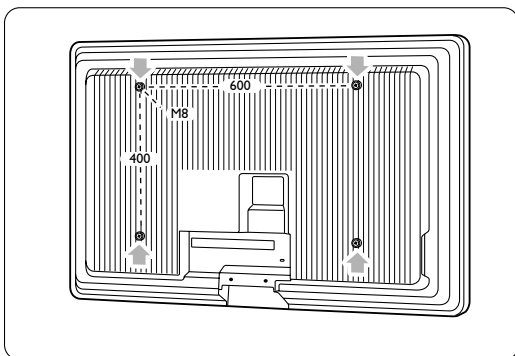

- 2** Should the plastic discs obstruct the VESA bracket, you can unscrew these 4 discs.

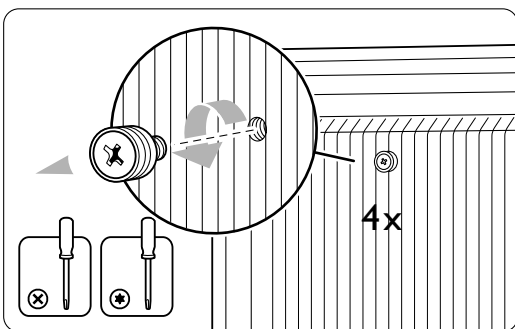

3.3 Remote control batteries

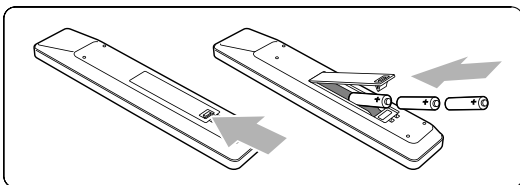

- 1 Open the battery cover on the back of the remote control.
- 2 Insert the 3 batteries supplied (Type AAA-LR03-1,5V). Make sure the **+** and **-** ends of the batteries line up correctly (inside of case is marked.)
- 3 Close the cover.

Note

Remove the batteries if you don't use the remote control for a long time.

3.4 Antenna cable

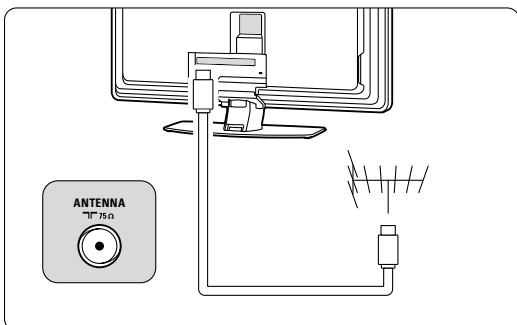

- 1 Locate the antenna connection at the back of the TV.
- 2 Insert the antenna cable tightly into the antenna socket **Antenna**.

3.5 Connect the mains cord

- 1 Verify that your mains voltage corresponds with the voltage printed on the sticker at the back of the TV. Do not insert the mains cord if the voltage is different.
- 2 Insert the mains cord tightly.

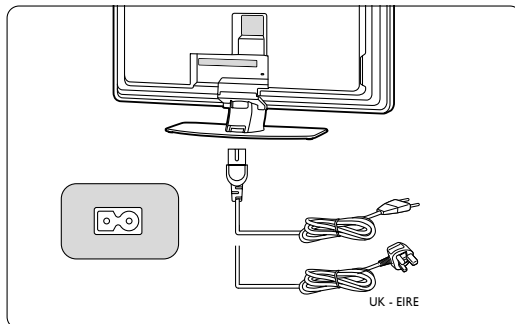

The TV is never powered off completely unless the mains cord is physically unplugged. Therefore the mains plug must be accessible at all time.

3.6 First time installation

The first time, and only the first time, the mains cord is inserted, the installation procedures starts up automatically. Follow the instructions on screen.



Tips



- If you notice you have selected a wrong language, press the red key on the remote control to return to the language selection menu.
- To rearrange the stored channels, see section **6.3 Rearrange stored channels**.

4 Use your TV

Learn how to operate your TV for daily use.

4.1 Switch on or off - Standby



To switch on the TV:

- Press  **Power** at the right side of the TV if the standby led is off.
- Press  on the remote control if the standby led is on.

To switch to standby:

- Press  on the remote control.

To switch on from standby without remote control:

- Press  **Power** at the side of the TV to switch off first and press  **Power** again to switch on.

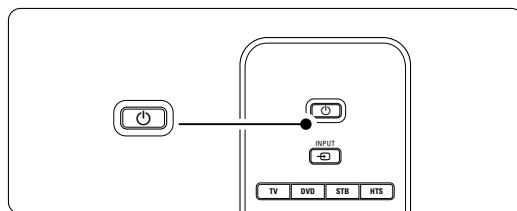
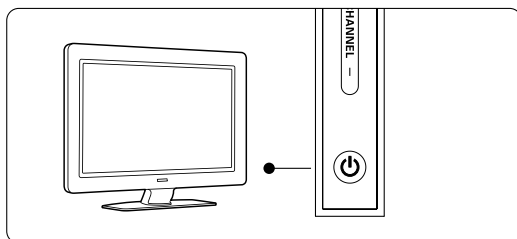

To switch off:

- Press  **Power** at the side of the TV.

Note

Energy consumption contributes to air and water pollution. As long as the mains cord is plugged in, the TV consumes energy. This TV has a very low standby power consumption.

4.2 Watch TV

4.2.1 Switch channels

- To switch TV channels:
 - Press a number (1 to 999) or press **P+** or **P-** on your remote control.
 - Press **Program/Channel -** or **+** on the side controls of the TV.
- Press **P⇄P** to return to the previously viewed TV channel.

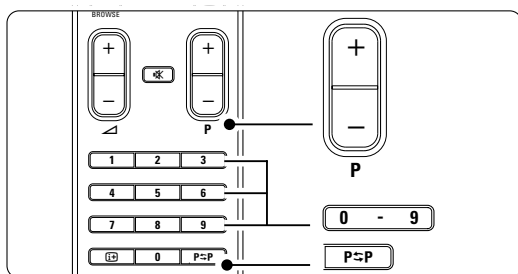

4.2.2 Adjust volume

- To adjust the volume:
 - Press **+ or -** on the remote control
 - Press **Volume + or -** on the side controls of your TV.
- To mute the sound:
 - Press **Mute** on the remote control
 - Press **Mute** again to restore the sound.

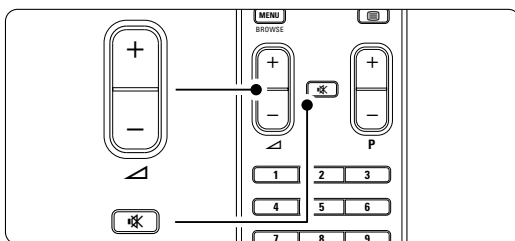

4.3 Watch channels from a digital receiver

- Switch on the digital receiver.
The picture from your receiver might appear automatically on your screen.
- Use the remote control of your digital receiver to select TV channels.

If the picture does not appear:

- Press **Input** on the remote control.

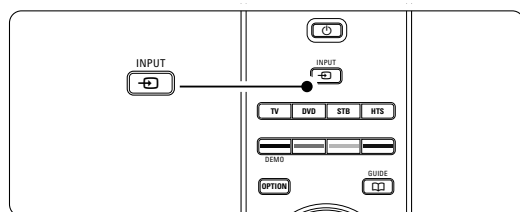

- Press **Input** repeatedly to select the device. Wait a few seconds until the picture appears.
- Press **OK**.
- Use the remote control of the digital receiver to select TV channels.

4.4 Watch connected devices

- Switch on the device.
The picture from your device might appear automatically.

If the picture does not appear:

- Press **Input** on the remote control.
- Press **Input** repeatedly to select the device. Wait a few seconds until the picture appears.
- Press **OK**.
- Use the remote control of your device to select TV channels.

4.5 Watch a DVD

- 1 Insert a DVD disc in your player.
- 2 Press **Play** ►.
The picture from your player appears automatically on your screen.

If the picture does not appear:

- 1 Press **INPUT** on the remote control.

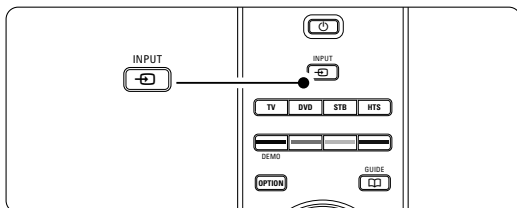

- 2 Press **INPUT** repeatedly to select the DVD player. Wait a few seconds until the picture appears.
- 3 Press **OK**.
- 4 Press **Play** ►.

4.6 Select a Teletext page

Most TV channels broadcast information via Teletext.

To watch Teletext:

- 1 Press **Teletext**.
The main index page appears.

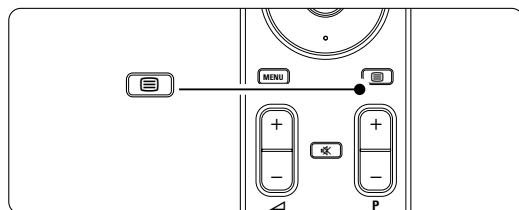

- 2 To select a page of your choice:
 - Enter the page number with the number keys.
 - Press **P-** or **P+** or navigation key up or down to view the next or the previous page.
 - Press a colour key to select one of the colour coded items at the bottom of the screen.

Tip

Press **P↔P** to return to the previously viewed page.

- 3 Press **Teletext** again to switch Teletext off.

Note

Only for UK: some digital TV channels offer dedicated digital text services (for example BBC1).

For more information on teletext, see section **5.5 Teletext**.

4.7 Change Ambilight mode

You can choose among three Ambilight modes and change the light intensity:

- **Relaxed**
Sets Ambilight to change soft and smoothly with the images on screen.
- **Moderate**
Sets Ambilight between Relaxed and Dynamic.
- **Dynamic**
Sets Ambilight to change quick and responsive.

To change the Ambilight mode:

- 1** Press **Ambilight** to switch on or off.

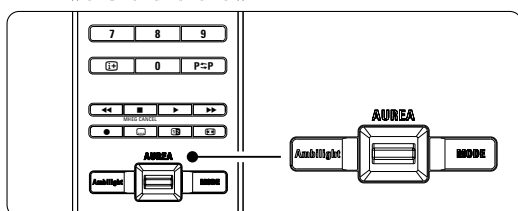

- 2** Press **Mode** repeatedly to toggle through the Ambilight modes.
- 3** Press **OK**.

For more information on Ambilight, see section [5.4 Ambilight](#).

Tip

To fully enjoy Ambilight, switch off or dim the room lights.

To change the light intensity of Ambilight:

- 1** Slide the **Aurea Ambilight** switch up or down to change the light intensity.

TV standby with Ambilight

When the TV is in standby, you can switch Ambilight on.

- 1** Press **Ambilight** on the remote control when the TV is in standby.
- 2** Press **Mode** repeatedly to select the available colours.

5 Use more of your TV

This section deals with the more advanced use of your TV:

- how to use the menus
- to adjust the picture, sound and Ambilight settings
- more about Teletext
- how to create favourite channel lists



- the advantages of Electronic Programme Guide
- how to set locks and timers
- to set subtitles and select a subtitle language
- how you can view your photos or play your favourite music from a USB memory device.

5.1 Remote control

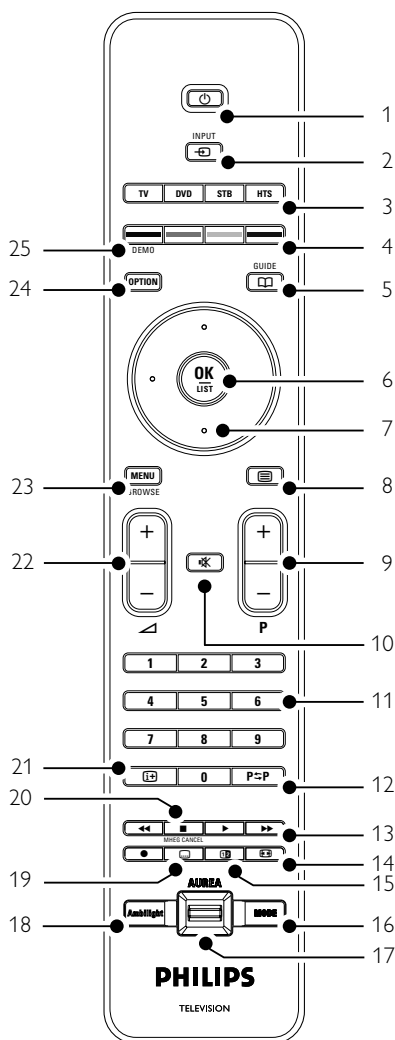
5.1.1 Remote control overview



- Standby** To switch the TV on or back to standby.
- Input** To select a connected device or to return to TV.
- TV DVD STB HTS** To control connected devices.
- Colour keys**
 - Easy selection of teletext pages.
 - Easy selection of tasks.
- Guide** To switch on or off the Electronic Programme Guide.
- OK/List**
 - To display the channel list.
 - To activate a setting.
- Navigation keys (up, down, left, right)** To navigate the menu.
- Teletext** To switch teletext on or off.
- +P- Channel up or down** To switch to the next or previous channel in the channel list.
- Mute** To mute the sound or restore it.
- Number keys** To select a TV channel.
- Previous channel** To return to the previously viewed channel
- Audio and video keys** To use with connected devices.
- Widescreen Picture format** To select a picture format.
- Dual screen** To show teletext on the right and the picture on the left of the screen.
- Mode** To toggle through the Ambilight modes
- Ambilight AUREA** To change the light intensity of Ambilight

- 18 **Ambilight**
To switch Ambilight on or off.
- 19 **Subtitles** 
To activate or deactivate the subtitle mode.
- 20 **MHEG cancel (only for UK)**
To cancel only Digital text or Interactive services.
- 21 **On screen information** 
To show channel or programme information if available.
- 22 **Volume up or down** 
To adjust the volume.
- 23 **Menu**
To switch the menu on or off.
- 24 **Option**
To switch the Quick access menu on or off.
- 25 **Demo**
To switch the Demo menu on and to get a demonstration of the features of the TV.

See section **10 Index** to find the section in the manual about a specific remote control key.

5.1.2 Operate other Audio/Video devices

This TV remote control can operate DVD devices, Set-Top Boxes and Home Theater Systems of Philips and many other brands. If the keys do not operate the selected device, a setup is required to programme the remote control for your specific brand and type of device.

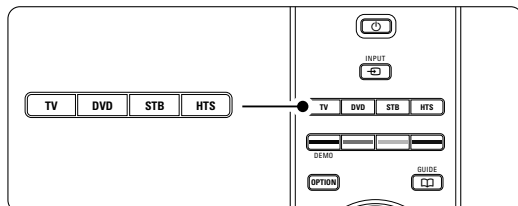

5.1.3 Set to operate a particular device

There are two ways to programme the remote control for a device of a particular manufacturer: You can enter a manufacturer's code or start an auto-search.

The manufacturer's setup codes contain:

- for **DVD**: DVD, DVD-R, HDD DVD-R, Blu-ray
- for **STB**: Satellite tuners, Settop box tuners/decoders, Cable tuners/decoders
- for **HTS**: Home Theater Systems, Audio/Video systems

The setup codes for most used Philips devices are:

DVD	001	Factory pre-set Philips DVD
DVD-R	004	Philips DVD-recorder
DVD-Harddisk	005	Philips DVD-Recorder Harddisk
BluRay	006	Philips HD BluRay player
STB (39)	002	Factory pre-set Philips Set-Top Box
STB (40)	007	(for some Philips Set-Top Boxes)
HTS	003	Factory pre-set Philips Home Theater System

There is a wider selection of Philips devices that can be programmed.

For other manufacturer's entry codes tables, see the end of this manual.

Note:

The remote control might not be compatible with all types of DVD, Set-Top Boxes and Home Theater Systems

Enter the setup code directly

1 Press the **DVD, STB** or **HTS** key for 4 seconds to select the device mode you need.

The selected mode key will light up constantly.

2 Enter the three-number code for the type and brand of your device. Most brands have more than one entry code.

If you entered the correct code, all mode keys will blink to confirm the selection.

If you entered a wrong code, all mode keys will light up for 2 seconds. Repeat Step 2 with a different code.

3 Point the remote control at the device, and press **⏻** to test if the code is correct for your device.

If successful try whether all functions can be operated. If not successful, or if not all functions can be operated, repeat Step 1 and 2 with one of the other setup codes for your manufacturer.

Automatic search of all codes

If you are not successful in finding the correct brand or code, you can try an automatic search of all codes. The automatic search might take several minutes.

If after the automatic search no code is successful, the remote control will likely not be able to operate your particular device. In such case, use the device's own remote control.

1 Switch on the device you want the TV remote control to set up for.

2 Point the remote control to the device.

3 To select the device mode you need, press the **DVD, STB** or **HTS** key for 4 seconds.

The selected mode key will light up constantly.

4 Press **OK** to start the automatic search.

Every two seconds, when a new code is sent, the **⏻** key will blink.

Keep pointing the remote control to the device.

5 When the device switches off, press **OK** to stop the search.

6 Press **⏻** to switch on your device.

7 Use the remote control keys to try if all functions can be operated.

If not all functions can be operated, press **OK** again to continue the automatic search for a correct code.

8 If all functions can be operated, press the currently selected device mode key to confirm and to quit the automatic search.

ⓘ Note:

To pause the automatic search, press **OK**. Press the navigation key up or down to search for the codes one by one backward or forward to locate the

correct code for your device or press **OK** again to continue the automatic search.

5.1.4 Operate DVD, Set-Top Box and Home Theater devices

1 Press the **DVD, STB** or **HTS** key to set the remote control to operate the device you need.

2 Use the TV remote control to operate the device.

If the keys do not operate the selected device, a setup is required to programme the remote control for your specific brand and type of device. See section 5.1.3

3 Press the **TV** key to return to normal TV mode. When not used, the remote control will switch back to TV mode after 30 seconds.

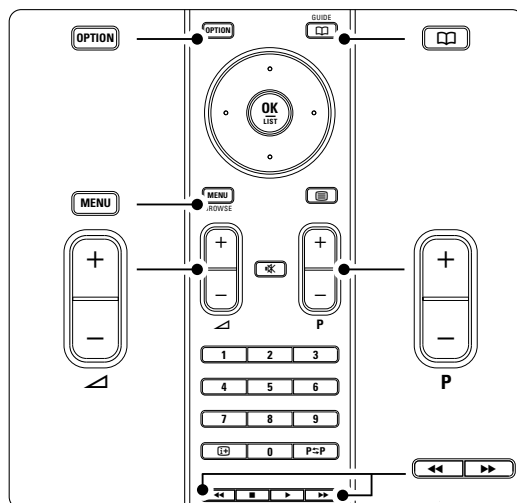

When the remote control is selected for a particular device all keys have the same function except the keys mentioned here.

- **DVD player, DVD recorder, DVD-HDD**
Option key = DVD System menu
Menu key = DVD Disc menu
P+/- = DVD Next/Previous track
- **Philips DVD Recorder (setup code 004)**
◀◀ key = DVD previous track
▶▶ key = DVD next track
- **Philips DVD recorder with HDD (setup code 005)**
Option key = DVD-R HDD Disc menu
Menu key = DVD-R HDD browser
◀◀ key = DVD-R HDD previous track
▶▶ key = DVD-R HDD next track

- **Philips Blu-ray Disc player (setup code 006)**
Option key = BD Home screen
Ⓛ key = BD Content menu
Menu key = BD Disc menu
- **Digital or Satellite receiver**
 No change of functions.
- **Home Theatre System**
Option key = HTS Set up
Menu key = HTS Disc menu
↙ key = HTS volume
P+/- = HTS Next/Previous

5.1.5 Keep the remote in the chosen mode permanently

If you operate a device selecting the **DVD**, **STB** or **HTS** key, the remote control will return to TV mode if you do not use it for 30 seconds. You can also set up the remote control to stay in the selected mode permanently.

- 1 Press the **TV** key to be in TV mode.
- 2 Press **OK** and **Ⓛ** at the same time for 4 seconds.
 The **Ⓛ** key will blink for 1 second to confirm. From now on the remote control will stay in the selected device mode.
- 3 Press the **TV**, **DVD**, **STB** or **HTS** key to operate the device you need.
 The **Ⓛ** key will blink a few times to confirm the selection.

5.1.6 Remote control entry codes tables

See the end of this manual.

5.2 TV menu overview

With the on screen menus you install your TV, adjust picture, sound and Ambilight settings and access features. This section gives an overview of the menus and describes how to navigate.

5.2.1 The menu

- 1 Press **Menu** on the remote control to show the main menu.
- 2 Press **Menu** to quit the menu.

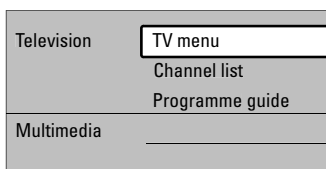
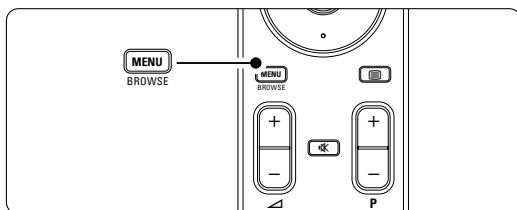

The main menu offers the following items:

- **TV menu**
 Select this menu for installation, picture and sound settings, Ambilight and other feature settings.
- **Channel list**
 Select this item to show the Channel list. Create your Favourite channel lists here.
- **Programme guide**
 Available when digital channels are installed, this item shows information about the digital programmes. According to the type of Electronic Programme Guide, you can also access the table of scheduled Digital TV programmes and easily select and tune to a desired programme. See section 5.7 **Electronic Programme Guide**.
- **Multimedia**
 Select this item to view photos or play music stored on a USB device. See section 5.10 **View and play photos, MP3, ...**

5.2.3 Quick access menu

The Quick access menu gives direct access to some often needed menu items.

When digital channels are installed and broadcasted the relevant digital options are shown in the menu.

- 1** Press **Option** on the remote control.
- 2** Press navigation key up or down to select an option.
- 3** Press **OK** to show the selected option menu.
- 4** Press navigation key up, down, left, right to adjust the settings in the menu.
- 5** Press **Option** to quit the menu.

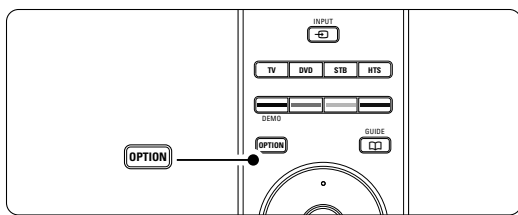

- **Audio language**
See section 5.3.5 Adjust sound settings.
- **Subtitle language**
See section 5.9.3 Select a digital subtitle language.
- **Subtitles**
See section 5.9 Subtitles.
- **Picture format**
See section 5.3.4 Widescreen picture format.
- **Equalizer**
See section 5.3.5 Adjust sound settings.
- **Clock**

Display the clock

- 1** Press **OK** to display the clock permanently.
- 2** Press **Option** and press navigation key up or down to select Clock again.
- 3** Press **OK** to hide the clock.

Quick access
Audio language
Subtitle language
Subtitle
Picture format
Equalizer
Clock

5.3 Picture and Sound settings

This section describes how to adjust picture and sound in the menus.

5.3.1 Settings assistant

Use the Settings assistant to guide you through basic picture, sound and Ambilight settings in an easy way.

- 1** Press **Menu** on the remote control and select TV menu > TV settings > **Settings assistant** and press navigation key right to enter.
- 2** Press **OK**.
- 3** Press the green key on the remote control to start the assistant.
- 4** Press navigation key left or right to select the left or right side to make your choice.
- 5** Press the green key to go to the next setting. You will go through several settings. When finished the TV will ask you to store these settings.
- 6** Press the green key to store all your settings.
- 7** Press **Menu** to quit the menu.

5.3.2 Reset to standards

Sets the TV to one of the predefined settings. Each setting combines picture, sound and Ambilight.

- 1** Press **Menu** on the remote control and select TV menu > TV settings > **Reset to standard** and press navigation key right to enter the list.
- 2** Press navigation key up or down to select a setting.
- 3** Press the green key to store your selection.
- 4** Press **Menu** to quit the menu.

Standard settings: Current, Natural, Vivid, Movie

5.3.3 Picture settings

This section describes how to adjust all picture settings.

- 1** Press **Menu** on the remote control and select TV menu > TV settings > **Picture** and press navigation key right to enter the list.
- 2** Press navigation key up or down to select a setting.

TV settings	Picture
Settings assistant	Contrast
Reset to standard	Brightness
Picture	Colour
Sound	Hue
Ambilight	Sharpness
	Tint
	Perfect Pixel HD
	HD Natural Motion
	100 Hz Clear LCD
	Dynamic contrast
	Noise reduction
	MPEG artefact red.
	Colour enhanc ...
	Active control
	Picture format

- **Contrast**
Changes the level of bright parts in the picture but keeps the dark parts unchanged.
- **Brightness**
Changes the level of light of the total picture.
- **Colour**
Changes the level of saturation.
- **Hue**
If NTSC is broadcasted, this level compensates the colour variations.
- **Sharpness**
Changes the level of sharpness of fine details.
- **Tint**
Sets the colours to Normal, Warm (reddish) or Cool (bluish). Select Custom to make a setting of your own in the Custom tint menu.
- **Custom tint**
If Custom is selected in the Tint menu you can make a setting of your own here.
Press the green key to select each bar to change the value of:
 - R-WP red whitepoint
 - G-WP green whitepoint
 - B-WP blue whitepoint
 - R-BL red blacklevel
 - G-BL green blacklevel

- **Perfect Pixel HD**
Enables or disables Perfect Pixel HD, the most ideal picture setting.
- **HD Natural Motion**
Reduces the field and line flicker and reproduces smooth movement especially in movies.
Set the level to Minimum, Maximum or Off.
- **100 Hz Clear LCD**
Switches 100 Hz Clear LCD on or off.
- **Dynamic contrast**
Enhances the contrast in the picture as the image on the screen changes.
Set the level to Minimum, Medium, Maximum or Off. The level medium is recommended.
- **Noise reduction**
Filters out and reduces the noise in the picture.
Set the level to Minimum, Medium, Maximum or Off.
- **MPEG artefact reduction**
Smoothens the transitions on digital pictures.
Switches MPEG artefact reduction on or off.
- **Colour enhancement**
Makes the colours more vivid and improves the resolution of details in bright colours.
Set the level to Minimum, Medium, Maximum or Off.
- **Active control**
Corrects all incoming signals in order to provide the best picture possible.
Switches Active control on or off.
- **Picture format**
See section 5.3.4 Widescreen picture format.

5.3.4 Widescreen picture format

Avoid black bars on the sides or on top and bottom of the picture. Change the picture format to a format that fills the screen.

- 1 Press  to switch on the Picture format menu.

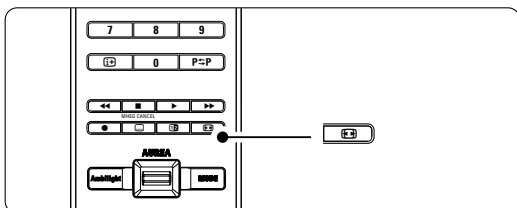

- 2 Press navigation key up or down to select an available picture format.
- 3 Press navigation key up to shift the picture upwards to make partly covered subtitles visible.

Tip

The Auto format setting is recommended for minimal distortion .

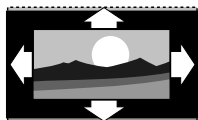

Auto format (Not for PC.)

Enlarges the picture automatically to fill the screen. Subtitles remain visible.

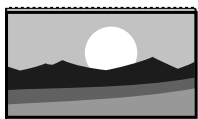

Super zoom (Not for HD.)

Removes the black bars on the side of 4:3 broadcasts. There is a minimal distortion.



4:3 (Not for HD.)

Shows the classical 4:3 format.

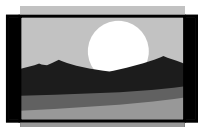

Movie expand 14:9

(Not for HD.) Scales classical 4:3 format to 14:9.

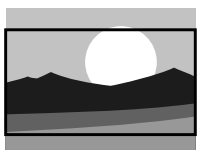

Movie expand 16:9

(Not for HD.) Scales classical 4:3 format to 16:9.



Wide screen

Stretches 4:3 format to 16:9.

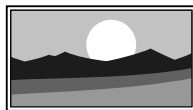

Unscaled

(Only for HD and PC.) Maximum sharpness. Distortion may appear on borders. Black bars may appear with pictures from your PC.

Note

Do not forget to name the connection in the Connection menu. See section 7.4.3 Naming your devices.

5.3.5 Sound settings

This section describes how to adjust all sound settings.

- 1 Press **Menu** on the remote control and select TV menu > TV settings > **Sound** and press navigation key right to enter the list.
- 2 Press navigation key up or down to select a setting.

TV settings	Sound
Settings assistant	Equalizer
Reset to standard	Volume
Picture	Balance
Sound	Audio language
Ambilight	Dual I/II
	Mono/Stereo
	Surround mode
	Headphone volume
	Auto volume level...
	Delta volume
	Auto surround

- **Equalizer**

Changes the bass and treble of the sound. Select each bar to change the setting. See also section **5.2.3 Quick access menu.**

- **Volume**

Changes the volume.

When adjusting the volume with  a volume bar appears. If you don't want it to appear go to TV menu > Installation > **Preferences** and press navigation key right to enter the list and select Volume bar off.

- 1 Press navigation key up or down to select **Volume bar.**
- 2 Press navigation key right to enter.
- 3 Select **On** to activate the temporarily display of the volume bar when adjusting the volume.

- **Balance**

Sets the balance of the left and right loudspeakers to fit best your listening position.

- **Audio language**

A list of audio languages for the current programme may be available when digital channels are installed and broadcasted. See also section 5.2.3 Quick access menu. To permanently change the audio language, see section **6 Channel installation.**

- **Dual I/II**

If broadcasted, you can choose between two different languages.

- **Mono/stereo**

If stereo broadcasting is available, you can select Mono or Stereo per TV channel.

- **Surround mode**

To select a more spatial sound if broadcasted or if available from a connected device.

- **Headphone volume**

Changes the volume of the headphone. You can mute the TV speakers with  on the remote control.

- **Automatic volume leveller**

Reduces sudden volume differences like at the beginning of commercials or when switching from one channel to another. Select on or off.

- **Delta volume**

Levels out volume differences between channels or connected devices.

- 1 Switch to the channel or device you want to level out the volume difference.
- 2 Select **Delta volume** in the Sound menu and change the volume level.

- **Auto surround**

Switches the TV automatically to the best surround sound mode broadcasted. Select on or off.

5.4 Ambilight

This section describes how to adjust Ambilight settings.

- 1 Press **Menu** on the remote control and select TV menu > TV settings > **Ambilight** and press navigation key right to enter the list.
- 2 Press navigation key up or down to select a setting.

TV settings	Ambilight
Settings assistant	Ambilight
Reset to standard	Brightness
Picture	Mode
Sound	Separation
Ambilight	Colour boost

- **Ambilight**
Switches Ambilight on or off.
- **Brightness**
Changes the light output of Ambilight.
- **Mode**
You can choose among three Ambilight modes: **Relaxed, Moderate, Dynamic**. See section 4.7 **Change Ambilight mode**.
- **Separation**
Sets the level of difference in colour between the left, right, top and bottom side of the TV.
Separation off shows a dynamic but mono colour Ambilight.
- **Colour boost**
Amplifies the colours for a more dynamic effect.

⚠ Caution

To avoid bad infrared remote control reception, place your devices out of sight of Ambilight.

5.5 Teletext

Your TV has a 1200 pages memory that stores broadcasted teletext pages and subpages to reduce waiting time.

To select a teletext page see section 4.6 **Select a Teletext page**.



5.5.1 Select pagenumber subpages

A teletext page number can hold several subpages. The pages are shown on a bar next to the main pagenumber.

- 1 Press .
- 2 Select a teletext page.
- 3 Press navigation key left or right to select a subpage.

5.5.2 Select T.O.P. teletext broadcasts

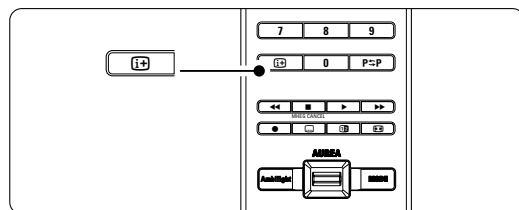

T.O.P. teletext (Table of Pages) is not broadcast by all TV channels. You can easily jump from one subject to another without using pagenumbers.

- 1 Press .
- 2 Press .
- 3 Use navigation key left, right or up, down to select a subject.
- 4 Press **OK** to view the page.



5.5.3 Dual screen teletext

View the TV channel and teletext next to each other.

- 1 Press  for Dual screen teletext.
- 2 Press  again to show normal teletext.
- 3 Press  to switch off teletext.

5.5.4 Search teletext

Quickly jump to a subject linked to a series of pagenumbers or search for specific words in teletext pages.

- 1 Press .
- 2 Press **OK** to highlight the first word or number.
- 3 Press navigation key left, right or up, down to jump to the next word or number on the page.
- 4 Press **OK** to search a page which holds the highlighted word or number.
- 5 Press navigation key up until no word or number is highlighted to quit Search.

5.5.5 Enlarge teletext pages

For a more comfortable reading, you can enlarge the teletext page.

- 1 Press  and select a teletext page.
- 2 Press **Option** on the remote control to enlarge the top part of the page.
- 3 Press **Option** again to view the enlarged lower part of the page.
- 4 Press navigation key up or down to scroll through the enlarged page.
- 5 Press **Option** again to return to the normal page size.

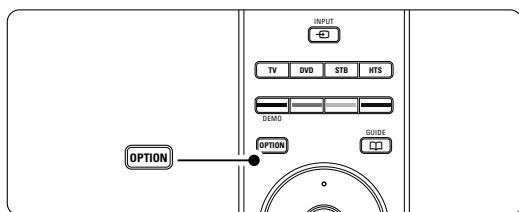

5.5.6 Teletext menu

With the options in the teletext menu you can reveal hidden info, let cycle subpages automatically and change the character setting.

- **Reveal**
Hide or unhide hidden information on a page, such as solutions to riddles or puzzles.
- **Cycle subpages**
If subpages are available for the selected page, you can make subpages cycle automatically.
- **Language**
Some languages use a different set of characters. Switch to the other group to show the text correctly.

- 1 Press .
- 2 Press **Menu**.

Teletext menu	
Reveal	Off
Cycle subpages	Off
Language	Gr. II

- 3 Press navigation key up or down to select an option.
- 4 Press **OK** to change a setting.
- 5 Press **Menu** to quit the teletext menu.
- 6 Press  to switch off teletext.

5.5.7 Digital text services (UK only)

Some digital TV broadcasters offer dedicated digital text or interactive services (for example BBC1) on their digital TV channels. These services work as normal Teletext with the number, colour and navigation keys to select and navigate.

- 1 Press .
- 2 Press navigation key left, right or up, down to select or highlight items.
- 3 Press one of the colour keys to select an option.
- 4 Press **OK** to confirm or activate.
- 5 Press **MHEG Cancel** to cancel Digital text or interactive services.

Caution

Digital text services are blocked when subtitles are broadcasted and Subtitle On is set in the Features menu. See section **5.9 Subtitles**.

5.5.8 Teletext 2.5

If broadcasted by the TV channel this teletext offers more colours and better graphics.

Teletext 2.5 is switched on as a factory setting.

- 1 Press **Menu** on the remote control and select TV menu > Installation > Preferences > **Teletext 2.5** and press navigation key right to enter the list.
- 2 Select on or off.

5.6 Create favourite channel lists

View the All channels list or set up a Favourite list of your own with your preferred TV channels and radio stations. For example, each member of your family can create his or her own favourite list.

5.6.1 Select a favourite list

Learn how to select one of the favourite channel lists.

- 1 Press **OK**.

The first time after you have finished the installation, the All channels list is shown. In other situations, it brings up the last selected favourite list.

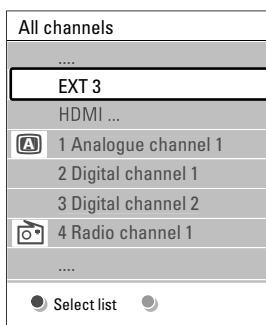

- 2 Press the red key to show all favourite lists.
- 3 Press navigation key up or down to select a list.
- 4 Press **OK**.
The selected favourite list appears.
- 5 Press **OK** again to quit.

5.6.2 To set up a favourite list

Create or modify your own favourite list.

- 1 Press **OK**.
The last selected list appears.
- 2 Press the red key to show all favourite lists.
- 3 Press navigation key up or down to select a list.
- 4 Press **OK**.
- 5 Press the green key to enter the Edit mode.
The selected list brings up a full channel list.
- 6 Press navigation key up or down to highlight a channel.
- 7 Press **OK** to mark (or unmark) the highlighted channel. The channel is added to (or removed from) the selected list.
- 8 Press the green key again to leave the Edit mode.
The modified channel list appears again.

5.6.3 Select a channel from a favourite list

- 1 Press **OK**.
The last selected channel list appears.
- 2 Use navigation key up or down to highlight a channel.
- 3 Press **OK**.
The TV tunes to that channel.

Tip

- Use **-P+** to go through the TV channels of the selected favourite list.
- With the number keys you can still select channels which are not marked as favourite.

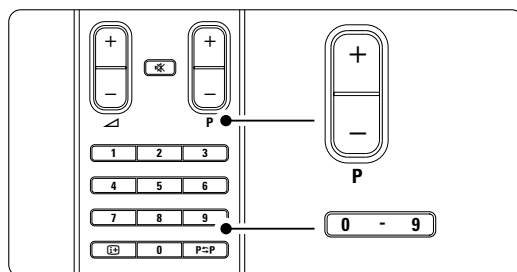

5.7 Electronic Programme Guide - EPG -

The Electronic Programme guide is an on screen guide to scheduled digital TV programmes. You can navigate, select and view programmes by time, title or genre. There are two types of EPG, 'Now and Next' and '7 or 8 day' EPG.

When digital channels are installed and broadcasted, EPG is available. 'Now and Next' is always available but the '7 or 8 day' EPG is only available in some countries.

With the EPG menu you can ...

- see a list of current broadcasted programmes
- see the next programme
- group programmes by genre
- set reminders when programmes will start
- set up preferred EPG channels
- etc.

5.7.1 Switch on EPG



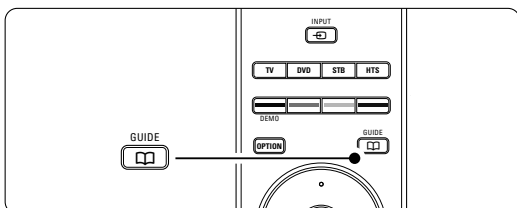

- 1 Press .



The following type of EPG appears:

'Now and Next' EPG

Detailed information about the current programme is shown.

26	BBC1	Tue., 12 Sep	09:17
Title : Commonwealth Games			
Info: 7:50 - 12:30 : 280 min			
 Exit	 Next		
Press -P+ to change channel.			

Or

'7 or 8 day' EPG

It may take some time to receive the EPG data. The list of TV programmes will show

Programme guide		Tue., 12 Sep	
	Around	09:55	Next
BBC ONE	07:50 Commonwealth	12:30	Commonwealth
BBC TWO	09:50 Tweenies	10:15	Something Special
five	09:00 The Wright Stuff	10:30	Trisha Goddard
BBC THREE	05:32 This is BBC THREE	12:00	This is BBC THREE
BBC FOUR	05:32 This is BBC FOUR	12:00	This is BBC FOUR
abc1	09:20 Moonlighting	10:15	Daddio

 Remind 13:50 Anastasia
  Watch
  Jump to ...
  Info 0010 - EEN

- 2 Use the colour keys to activate the available actions at the bottom of the screen.
 - **Next:** to show information about the next programme.
 - **Remind:** to mark or unmark a programme as a reminder.
 - **Watch:** to watch or listen to a current programme.
 - **Jump to...:** to jump to the next or previous day.
 - **Info:** to display information on a selected programme (if available).
- 3 Press  to quit the EPG.

5.7.2 More on '7 or 8 day' EPG

Search by genre, scheduled reminders, etc. are managed in the Programme guide menu.

- 1 Press  on the remote control.
- 2 Press **Menu**.

The Programme guide menu appears.

Programme guide	What's on
What's on	12:30 South Today
Search by genre	11:50 Working Lunch
Scheduled remind...	11:55 Melrose Place
Preferred EPG ch...	13:00 In aller Freund
Acquire EPG data	

- 3 Press navigation key up or down to select a menu option.
- 4 Press navigation key right to enter.
- 5 Press navigation key up or down to make a selection.
- 6 Press **OK** to activate or press the green key to watch
- 7 Press  to quit the EPG.

Note

Only channels marked as Preferred EPG channels appear in the Programme guide menu.

5.8 Timers and locks

This section describes how to switch the TV on or off at a specified time and to lock or unlock the TV.

5.8.1 Automatically switch to standby

Sleeptimer switches the TV to standby after a time.

- 1 Press **Menu** on the remote control and select TV menu > Features > **Sleeptimer** and press navigation key right to enter the sleeptimer bar.
- 2 Press navigation key up or down to set the time up to 180 minutes in steps of 5 minutes. If set to 0 minutes, the Sleeptimer is switched off.

You can always switch off your TV earlier or reset the time during countdown.

5.8.2 Automatically switch the TV on

On timer switches the TV on automatically to a specified channel at a specified time, from standby.

- 1 Press **Menu** on the remote control and select TV menu > Features > **On timer** and press navigation key right to enter the On timer menu.
- 2 Use navigation key left, right or up, down to select and enter the menu items one by one to set a channel, a day of the week or daily, and a starting time.
- 3 Press **OK** to confirm.
- 4 Press **Menu** to quit the menu.

Tip

To switch off the On timer, select **Off** in the On timer menu.

5.8.3 Lock TV channels and programmes

Lock TV channels and/or programmes from connected devices to prevent children from watching them. Lock and unlock with a four number code.

Set or change your code

- 1 Press **Menu** on the remote control and select TV menu > Features > **Set or Change code** and press navigation key right to enter your code.
- 2 Enter your code with the number keys.
The **Features** menu reappears with a message confirming that your code has been created or changed.

Did you forget your code ?

- 1 Select **Change code**.
- 2 Press navigation key right.
- 3 Enter the overriding code 8-8-8-8.
- 4 Enter a new personal code.
- 5 Confirm your new entered code.
The previous code is erased and the new code is stored.

5.8.4 Activate or deactivate Child lock

If your code is set, you can lock all channels and devices, lock a specific channel or device, set a time after which all channels and devices are locked or set the age of your child for parental rating when digital channels are installed and broadcasted.

- 1 Press **Menu** on the remote control and select TV menu > Features > **Child lock** and press navigation key right to enter your code.
- 2 Enter your code with the number keys.
- 3 Select one of the options.
- 4 Press navigation key right.

Lock or unlock all channels and connected devices

- 1 Select **Lock** or **Unlock**.
- 2 Press **OK**.

Lock a certain programme or all channels from a certain time

Child lock	Custom lock
Lock	Lock after
Custom lock	Channel lock
Unlock	Parental rating

- 1 Select **Custom lock**.
- 2 Press navigation key right to enter the Custom lock menu.
- 3 Press navigation key right again to enter the Lock after menu.
- 4 Select **On** to switch on the Timer lock.
- 5 Press navigation key left.
- 6 Select **Time**.
- 7 Press navigation key right.
- 8 Enter the time with navigation key up or down and right.
- 9 Press **OK**.

Lock one or more channels and connected devices

- 1 Select **Custom lock**.
- 2 Press navigation key right to enter.
- 3 Press navigation key up or down to select **Channel lock**.
- 4 Press navigation key right.
- 5 Press navigation key up or down to select the channel(s) you want to lock or unlock.
- 6 Each time press **OK** to lock or unlock the channel.

Set an age rating to a digital programme



Some digital broadcasters have their programmes rated (depending on your country). When the rating is higher than your child's age, the programme will be locked.

- 1 Select **Custom lock**.
- 2 Press navigation key right to enter.
- 3 Press navigation key up or down to select **Parental rating**.
- 4 Press navigation key right.
- 5 Press navigation key up or down to select an age rating.
- 6 Press **Menu** to quit the Child lock menu.

5.9 Subtitles

For each TV channel, subtitles can be set, coming from Teletext or DVB-T (digital) broadcasts. If digital channels are installed and broadcasted, you can select your preferred subtitle language.

5.9.1 Subtitling from analogue TV channels

- 1 Select an analogue TV channel.
- 2 Press  to switch on Teletext.
- 3 Enter the three number pagenumber of the subtitle page.
- 4 Press  to switch off Teletext.

Note

The Teletext subtitle page of analogue channels must be stored for each TV channel separately.

5.9.2 Activate or deactivate subtitling

- 1 Press **Menu** on the remote control and select TV menu > Features > **Subtitle** and press navigation key right to enter the list.

TV menu	Features
TV settings	Subtitle
Features	Subtitle language
Installation	Sleeptimer
Software update	Child lock
	Set/Change code
	On timer
	Common interface
	Demo

- 2 Press navigation key up or down to select **On** to show the subtitles always or **On during mute** to show the subtitles only when the sound is muted with the  key on the remote control.
- 3 Press navigation key left to return to the Features menu.

Tip

Select the Subtitle menu directly with **Option** on the remote control. See section 5.2.3 **Quick access menu**.

5.9.3 Select a digital subtitle language

If subtitle broadcasting is available with digital channels, you can select a preferred subtitle language out of a list of broadcasted languages. The preferred subtitle language set in the Installation menu is overruled temporarily.

- 1 Press **Menu** on the remote control and select TV menu > Features > **Subtitle language** and press navigation key right to enter the list of available languages.
- 2 Press navigation key up or down to select a subtitle language.
- 3 Press **OK**.

Tip

Select the Subtitle language menu directly with **Option** on the remote control. See section 5.2.3 **Quick access menu**.

5.10 View and play: photos, MP3, ...

Watch pictures or listen to music stored on a USB device (not supplied with the TV). Watch your pictures as a slideshow or listen to a self made music playlist.

Note

Philips can not be held responsible if your USB device is not supported nor shall Philips accept any liability for damage or loss of stored data.

5.10.1 Insert a USB device

Insert a device at the side of the TV while the TV is switched on.

The main menu appears automatically and the name of the USB device is highlighted next to **Multimedia**.

Television	TV menu Channel list Programme guide
Multimedia	

5.10.2 Remove the USB device

Caution

To avoid damaging the USB device always quit the menu on screen and wait five seconds before you remove the USB device.

- 1 Press **Menu** to quit the menu.
- 2 Remove the USB device.

5.10.3 View your pictures

The Multimedia menu shows the files you have stored on your USB device.

- 1 Press navigation key right to enter the Multimedia menu.
Picture is highlighted.

USB	Picture
Picture	Afrika_2001
Music	Paris_2006
	My_car.jpg
	Jean.jpg
	Mary.jpg

- 2 Press navigation key right to enter the Picture folder.
- 3 Press navigation key up or navigation key down to select a picture or a picture album on the USB device.

Picture	Afrika_2001
Afrika_2001	Kenya.jpg
Paris_2005	Congo.jpg
My_car.jpg	Victoria.jpg
Jean.jpg	Dakar.jpg
Mary.jpg	Cairo.jpg

Afrika_2001	Afrika_2001
Kenya.jpg	 Kenya.jpg
Congo.jpg	
Victoria.jpg	
Dakar.jpg	
Cairo.jpg	

- 4 Press **OK** to view the picture or to start a slideshow of the pictures in the album.
- 5 Press **OK** to pause the slideshow. Press again to restart.
- 6 Press one of the colour keys on the remote control to perform the corresponding function shown at the bottom of the screen.
Press the blue key to stop the show and to see more functions.
If the function bar at the bottom disappeared, press any colour key to let it reappear.
- 7 Press navigation key left and select another picture or another album.

Slideshow settings

- **Details / More details**
Shows the picture name, date, size and next picture in the slideshow.
- **Transitions**
Shows the list of available transition styles of the pictures.
Press navigation key up or down to select and press **OK** to activate.
- **Slide time**
Sets the time lag for the picture transitions:
Short, Medium or Long.
- **Rotate**
To rotate a picture.
- **Zoom**
Show a list of available zoom magnifications to select.
- **Start/Show**
To stop and restart the slideshow.

5.10.4 Thumbnails

View the pictures of a selected album in an overview.

- 1 Select a picture album.
- 2 Press navigation key right to enter the picture list.
- 3 Press the green key.
- 4 Press navigation key up or down, left or right to highlight a picture.
- 5 Press **OK** to view the picture.
- 6 Press navigation key left to return to the thumbnail overview.
- 7 Press the green key again to go back to the picture list.

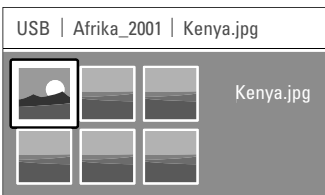

5.10.6 Slideshow with background music

Watch a slideshow of your stored pictures accompanied with your stored background music.

- 1 Select an album of songs first and press **OK**.
- 2 Highlight the Picture folder and select an album of pictures and press **OK**.

5.10.5 Listen to music

Find your songs in the Music album of the Multimedia menu.

- 1 Highlight **Music** in the Multimedia menu.
- 2 Press navigation key right to enter the Music folder.
- 3 Press navigation key up or down to select a song or a music album.
- 4 Press **OK** to play the selected song or to play a song followed by the next song in the same album.

Music settings

- **Details**
Shows the file name.
- **Repeat one/all**
Repeat all songs in the album until you stop a song or only repeat the one song selected until you stop the song.
- **Shuffle**
Play songs in a random sequence.

5.11 Listen to radio channels

If digital broadcasting is available, digital radio channels will be installed during installation.

To listen to a digital radio channel:

- 1** Press **OK** on the remote control.
The **All channels** menu is displayed.
- 2** Use the number keys to select a radio channel available from channel number 400 onwards.
To reorder see section **6.3.3 Reorder the channels**.
- 3** Press **OK**.

5.12 Software update

Philips continuously tries to improve its products. It may be recommended for you to update the TV's software. To update your TV software you need a USB Memory device (not supplied).

Note

The device must have at least 48Mb free space. Make sure the write protection is turned off. Some USB devices do not work with our TV. Contact your dealer.

5.12.1 Update assistant

The Update assistant helps you to update the TV's software.

TV identification

The TV will identify itself to your USB memory device.

- 1** Press **Menu**.
- 2** Press navigation key right.
- 3** Press navigation key up or down to select **Software update**.
- 4** Press navigation key right.

TV menu	Software update
TV settings	Update assistant
Features	Current software...
Installation	Local updates
Software update	Announcement

- 5** Press navigation key up or down to select **Update assistant**.
- 6** Press navigation key right.
- 7** Press **OK** to activate.
- 8** Insert a USB memory device to the USB connector at the side of the TV.
The main menu appears.
- 9** Press the green key to proceed.
A message appears the TV has successfully written the identification file to the USB memory device.
- 10** Press the green key again to finish.
- 11** Remove the USB memory device from the TV.

5.12.2 Software download from the PC to the USB device

- 1 Insert the USB memory device into a PC linked to the internet.
- 2 Locate and open the file "update.htm" on your USB device.
- 3 Read the instructions on screen and click on the **Send ID** button.
The software update is downloaded on the USB memory device.
- 4 Remove the USB memory device from your PC.

5.12.3 Transfer of the downloaded software update to the TV

The downloaded software on the USB memory device must now be uploaded to your TV.

⚠ Caution

- Do not remove the USB memory device during the software update.
- If a power drop occurs during the update, do not remove the USB memory device from the TV.
The TV will continue the update as soon as the power comes back.

- 1 Insert the USB memory device to the USB connector at the side of the TV.

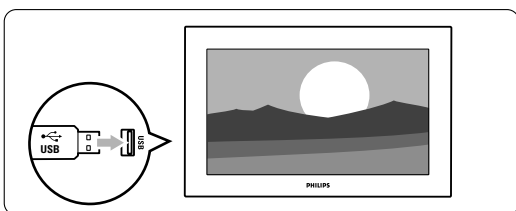

- 2 The TV switches off. The screen stays black for about 10 seconds. Wait and do not use the power switch  on the TV.

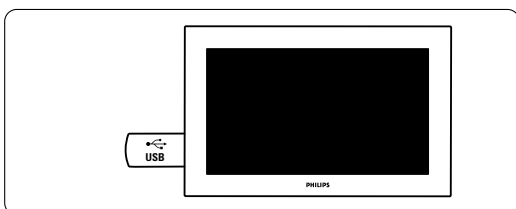

- 3 The update process starts automatically. Please wait.

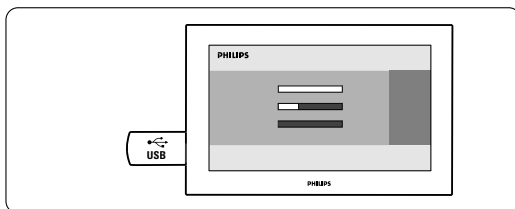

The update is finished when the message 'Operation successful' appears on the screen.

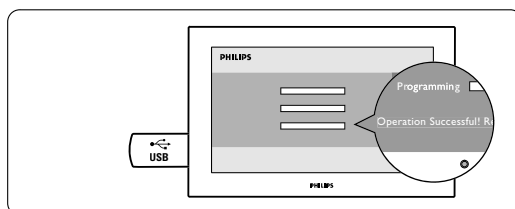

- 4 Remove the USB memory device from the TV.

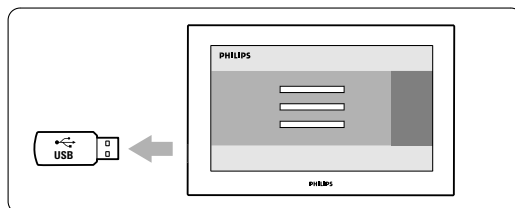

- 5 Press  on the remote control.

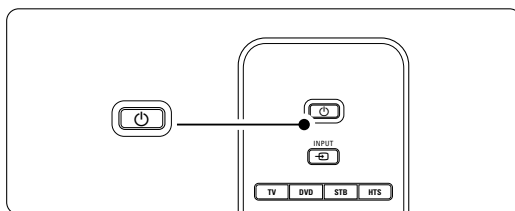

⚠ Note

Do not press more than once and do not use the Power  switch on the TV.

- 6** The TV switches off. The screen stays black for about 10 seconds. Please, wait.

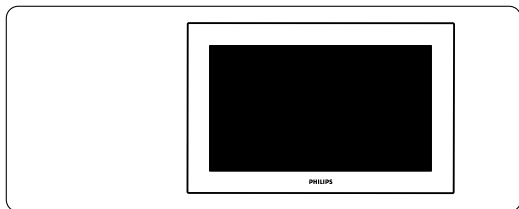

- 7** The TV switches back on again. The update is done.

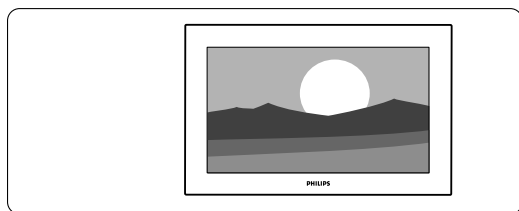

5.12.4 Verify the current software version

Updating software is only possible if the version of the new available software is different from the current one. You can verify your current software version.

- 1** Select **Software update** in the TV menu.
- 2** Press navigation key right.
- 3** Press navigation key up or down to select **Current software info**.

The version and the description of the current software appears.

5.12.5 Software update by digital broadcast (DVB-T)

Your TV might receive new software from the digital broadcast system automatically.

If you receive an update message on screen it is strongly advised to update the software immediately - select **Now**.

Select **Later**, if you want to be reminded later on.

Select **Cancel** to quit the update (not recommended). If you cancelled the update you can still update yourself from the TV menu > Software update > Local update.

6 Channel installation

The first time you switched on your TV you've selected the language of the TV menus and all the available channels have been installed.

This chapter will help you if you find it necessary to re-do the initial installation or if you want to tune in a new analogue TV channel.

Notes:

- You do not have to follow every step described if it is not necessary.
- Re-installation will modify the All channels list and new added channels will not be added to any favourite list.

6.1 Automatic installation

This section describes how to search for and store all available channels automatically.

Step 1 Menu language

Sets the language of the TV menus.

Go to a next step if your language settings are correct.

- 1 Press **Menu** on the remote control and select TV menu > Installation > **Languages** and press navigation key right to enter **Menu language**.
- 2 Press navigation key up or down to select your language.
- 3 Press **OK** to confirm.
- 4 Press navigation key left to return to the Installation menu.

Installation	Languages
Languages	Menu language
Country	Preferred audio
Time zone	Preferred subtitles
Channel install...	Hearing impaired
Preferences	
Connections	
...	

The Languages menu also offers the following language settings when digital channels are installed and broadcasted.

• Preferred audio

Select one of the available audio languages as preferred language.

• Preferred subtitles

Select one of the available subtitle languages as preferred language. See section **5.9 Subtitles**.

• Hearing impaired

Select **On** to display the hearing impaired subtitle version of your preferred audio or subtitle language when available.

Step 2 Select your country

Select the country where you are located. The TV will install and arrange the TV channels according to your country.

- 1 Press navigation key down to select **Country**.
- 2 Press navigation key right to enter the list.
- 3 Press navigation key up or down to select your country.
- 4 Press navigation key left to return to the Installation menu.

Step 3 Time zone selection

Only available for countries with different time zones.

- 1 Press navigation key down to select **Time zone**.
- 2 Press navigation key right to enter the list.
- 3 Press navigation key up or down to select your time zone.
- 4 Press navigation key left to return to the Installation menu.

Step 4 Install TV and radio channels

Your TV will search for and store all available digital and non-digital TV channels and all available digital radio channels.

- 1 Press navigation key down to select **Channel installation**.
- 2 Press navigation key right to enter the Channel installation menu.
Automatic installation is highlighted.
- 3 Press navigation key right to select **Start now**.
- 4 Press **OK**.
- 5 Press the green key to start.

The installation may take a few minutes.

- 6 When the channel search is completed, press the red key to return to the Installation menu.
- 7 Press **Menu** to quit the TV menu.

Tip

When digital TV channels are found, the list of installed channels may show some empty channel numbers.

If you want to rename, reorder or uninstall stored channels, see section **6.3 Rearrange channels**.

6.2 Analogue: Manual installation

You can tune-in analogue TV channels channel by channel manually with Manual installation.

6.2.1 Select the system

- 1 Press **Menu** on the remote control and select TV menu > Installation > Channel installation > **Analogue: Manual installation**.
- 2 Press navigation key right to enter the Manual installation menu.
System is highlighted.
- 3 Press navigation key right to enter the System list.
- 4 Press navigation key up or down to select your country or part of the world where you are now located.
- 5 Press navigation key left to return to the Manual installation menu.

Channel install...	Analogue: Manual...
Automatic install...	System
Installation update	Search
Digital: Test recept...	Fine tune
Analogue: Manual...	Store current ch...
Rearrange	Store as new ch...

6.2.2 Search for and store a new channel

- 1 Press **Menu** on the remote control and select TV menu > Installation > Channel installation > Analogue: manual installation > **Search**.
- 2 Press navigation key right to enter the Search menu.
- 3 Press the red key to enter the frequency yourself or press the green key to search for a next channel.

Tip

If you know the frequency, enter the three numbers of the frequency with the number keys of the remote control.

- 4 Press navigation key left when the new channel has been found.
- 5 Select **Store as new channel** to store the new channel under a new channel number.
- 6 Press navigation key right to enter.
- 7 Press **OK**.
Done appears.
- 8 Press **Menu** to quit the channel installation menu.

6.2.3 Fine tune a channel

Fine tune a found channel when the reception is poor:

- 1 Press **Menu** on the remote control and select TV menu > Installation > Channel installation > Analogue: manual installation > **Fine tune**.
- 2 Press navigation key right to enter the Fine tune menu.
- 3 Press navigation key up or down to adjust the frequency
- 4 Press navigation key left when you finished fine tuning.
- 5 Select **Store current channel** to store the fine tuned channel under the current channel number.
- 6 Press navigation key right to enter.
- 7 Press **OK**.
Done appears.
- 8 Press **Menu** to quit the Channel installation menu.

6.3 Rearrange stored channels

To rename, reorder, uninstall or reinstall stored channels.

6.3.1 Rename a channel

Assign or change a channel name to a channel for which a name has not yet been entered.

- 1 Press **Menu** on the remote control and select TV menu > Installation > Channel installation > **Rearrange**.
- 2 Press navigation key right to enter the channel list.
- 3 Press navigation key up or down in the channel list to select the channel you want to rename.
- 4 Press the red key.
- 5 Press navigation key left or right to select a character or up or down to change the characters. Space, numbers and other special characters are located between **z** and **A**.
- 6 Press the green key or **OK** to finish.

Tip

With the yellow key all characters can be deleted. With the blue key you can delete the character which is highlighted.

6.3.2 Uninstall or reinstall a channel

To uninstall a stored channel so that it is no longer possible to tune to.

Reinstall an earlier uninstalled channel.

- 1 Press **Menu** on the remote control and select TV menu > Installation > Channel installation > **Rearrange**.
- 2 Press navigation key right to enter the channel list.
- 3 Press navigation key up or down in the channel list to select the channel you want to uninstall or reinstall.
- 4 Press the green key to uninstall or reinstall the channel.
- 5 Press **Menu** to quit the menu.

6.3.3 Reorder the channels

Change the order of the stored channels.

- 1 Press **Menu** on the remote control and select TV menu > Installation > Channel installation > **Rearrange**.
- 2 Press navigation key right to enter the channel list.
- 3 Press navigation key up or down in the channel list to select the channel you want to reorder.
- 4 Press the yellow key to move up the highlighted channel in your channel list.
- 5 Press the blue key to move down the highlighted channel in your channel list.
- 6 Press **Menu** to quit the menu.

6.4 Automatic channel management

Once a day, at 3 AM, all available TV channels are updated automatically. The update is done if your TV is in standby.

Earlier stored channels not found by the update will be removed from the channel list.

You can do this update yourself anytime.

- 1 Press **Menu** on the remote control and select TV menu > Installation > Channel installation > **Installation update**.
- 2 Press navigation key right to enter the Installation update menu.
- 3 Press **OK**.
- 4 Press the green key to start.
The update starts and may take a few minutes.
- 5 When the update is completed, press the red key to return to the Channel installation menu.
- 6 Press **Menu** to quit the menu.

6.5 Digital reception test

If you receive Digital TV broadcasting you can check the quality and signal strength of a specific channel.

- 1 Select a channel.
- 2 Press **Menu** on the remote control and select TV menu > Installation > Channel installation > **Digital: Test reception**.
- 3 Press navigation key right to enter
- 4 Press **OK**.
The channel frequency, the network name, the signal quality and strength appear.
- 5 Press the green key to start or directly enter the frequency of the channel you want to test.
If the signal quality and strength are poor, reposition the antenna.
- 6 Press the yellow key to store the frequency if the signal quality and strength are good.
- 7 Press the red key to return to the Channel installation menu.
- 8 Press **Menu** to quit the menu.

Tip

To achieve the best results, contact a specialised antenna installer.

6.6 Factory settings

If you are lost in the picture, sound and Ambilight settings, you can reset the TV to the factory settings of picture, sound and Ambilight

- 1 Press **Menu** on the remote control and select TV menu > Installation > **Factory settings**.
- 2 Press navigation key right to enter the Factory settings menu.
- 3 Press **OK**.
- 4 Press **Menu** to quit the menu.

Note

The channel installation settings are not changed.

7 Connections

7.1 Connection overview

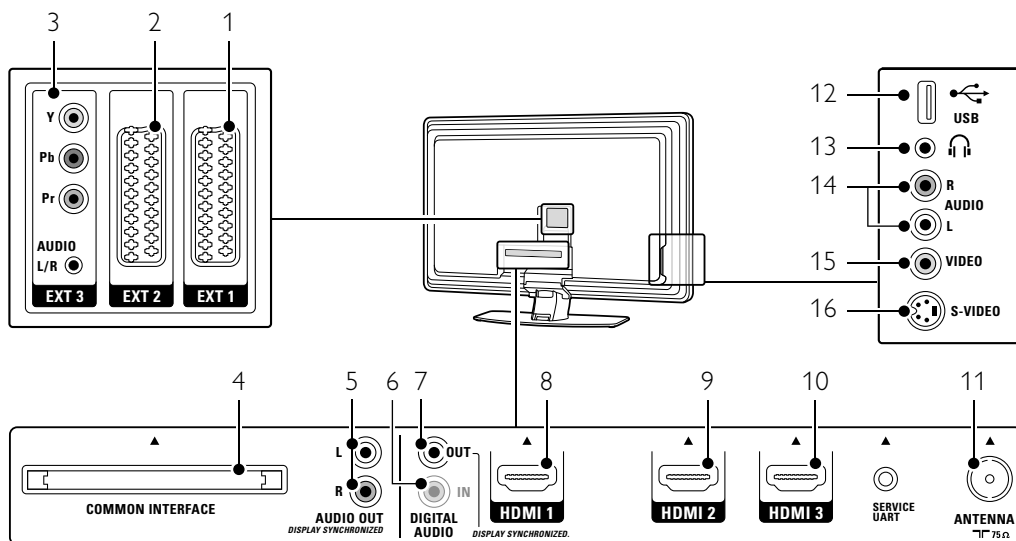

Back connectors

- 1 **EXT1**
Scart connector for DVD, VCR, digital receiver, game console, etc.
- 2 **EXT2**
Second scart connector.
- 3 **EXT3**
Component Video Y Pb Pr and Audio L/R connectors for DVD, digital receiver or game console, etc.
- 4 **Common Interface**
Slot for Conditional Access Modules (CAM)
- 5 **Audio Out L/R**
Sound output cinch connectors for a Home Theatre System, etc.
- 6 **Digital Audio In** (if present)
Sound input cinch connector for use with any of the HDMI connectors with a HDMI to DVI adaptor.
- 7 **Digital Audio Out**
Sound output cinch connector for a Home Theatre System, etc.
- 8 **HDMI 1 In**
HDMI in connector for Blu-ray Disc player, HD digital receiver or HD game console, etc.

- 9 **HDMI 2 In**
Second HDMI in connector.
- 10 **HDMI 3 In**
Third HDMI in connector.
- 11 **Antenna input**

Side connectors

- 12 **USB**
USB connector.
- 13 **Headphones**
Stereo Mini Jack.
- 14 **Audio L/R in**
Audio L/R for camcorder, game console, etc.
- 15 **Video**
Video input cinch connector to be used together with Audio L/R connectors for camcorder, game console, etc.
- 16 **S-Video**
S-Video input connector to be used together with Audio L/R connectors for camcorder, game console, etc.

7.2 About connecting

Learn here how to make the best connection for your device.

Six connections are ready to use at the back of the TV - EXT1, EXT2, EXT3, HDMI1, HDMI2 and HDMI3. Connect your device with the highest possible quality connection. Look for the highest quality connection on your device. Use that connection to your TV.

Connection set up

When connecting is done the TV needs to know what connections you made, which device is connected to which connector. Use the TV menu to do this. See section 7.4 Connection set up.

7.2.1 HDMI - Highest quality ★★★★★

A HDMI connection has the best picture and sound quality. One cable combines video and audio signals. Use HDMI for HD (High Definition) TV signals. HDMI can offer easy operation of your devices by the touch of one button when these devices have HDMI with CEC. A device connected with HDMI to the TV can only send out audio and video signals to your TV. The device cannot receive or record audio and video from your TV.

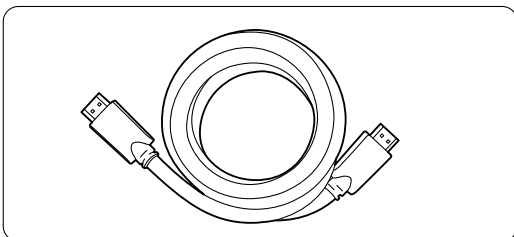

HDMI cable (max. 5m)

⊕ Tip

Use a HDMI / DVI adaptor in case your device has only a DVI connection. An extra audio cable is needed to complete this connection.

⊖ Note

HDMI supports HDCP (High-bandwidth Digital Contents Protection). HDCP is a copy protection signal that comes with HD content (DVD disc or Blu-ray Disc).

7.2.2 HDMI with CEC (if present)

HDMI with Consumer Electronics Control (CEC) adds to the normal HDMI advantages. It offers easy operation of the TV and connected devices. These devices also have to be equipped with HDMI with CEC.

- 1 Press **Menu** on the remote control and select TV menu > Installation > **Preferences** and press navigation key right to enter the list.
- 2 Press navigation key up or down to select **HDMI-control**.
- 3 Press navigation key right to enter.
- 4 Select **On** to activate HDMI with CEC.

⊖ Note

HDMI with CEC might not work with other brands.

One touch play

Insert a DVD disc to watch and your TV will switch on from standby and show the DVD programme automatically when you start playing the disc.

- 1 Press **Play ▶** on the device.
The TV is switched on from standby.

System standby

Switches off all devices with the TV remote control.

- 1 Press **⏻** on the TV remote control for a few seconds.
All devices will switch to standby.

7.2.3 YPbPr - Higher quality ★★★★

Use the Component Video YPbPr connections together with the Audio L/R mini jack. Match the cable colours when you connect. YPbPr can handle HD TV signals.

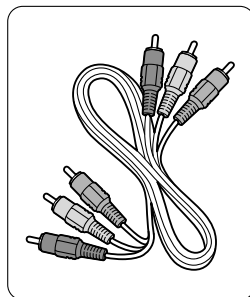

Component Video YPbPr cable
- Red, Green, Blue

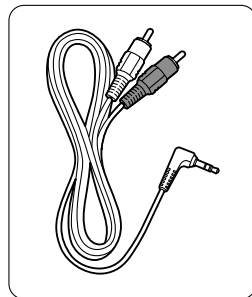

Audio L/R to Stereo mini jack cable

7.2.4 Scart - Good quality ★★★

One cable combines video and audio signals. Scart connectors can handle RGB video but no HD TV signals.

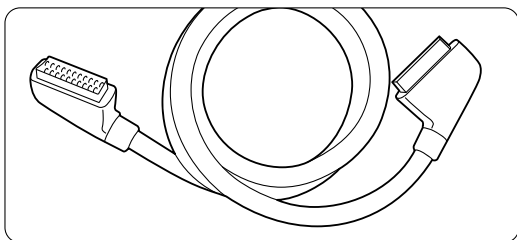

Scart cable

7.2.7 Display synchronised audio out

For the best match of image and sound in speech on screen, connect a Home Theatre System to Audio Out L/R or Digital Audio outputs.

See diagrams 7.3.4 and 7.3.8.

Do not connect the audio signal of a DVD player, digital receiver or other audio/video device directly to the Home Theatre System.

7.2.5 S-Video - Good quality ★★

Use a S-Video cable together with an Audio L/R (cinch) cable. Match the cable colours when you connect.

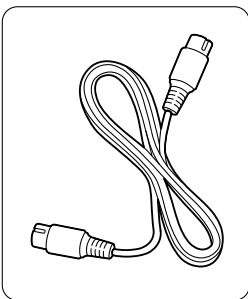

An S-Video cable

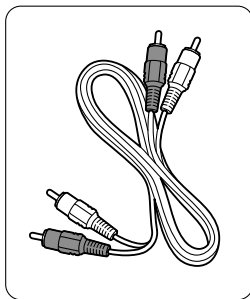
Audio L/R cable
- Red, White**7.2.6 Video** - Basic quality ★

Use a Video (cinch) cable together with an Audio L/R (cinch) cable. Match the cable colours when you connect

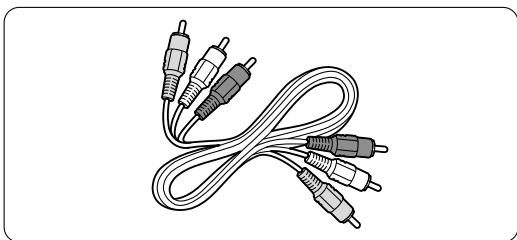
Combined Video - yellow and Audio L/R cable
- red and white

7.3 Connect your devices

The connections shown in this section are recommendations for the most used cases. Other solutions may be possible.

7.3.1 DVD player

Use a scart cable to connect the device to the EXT1 input at the back of the TV.

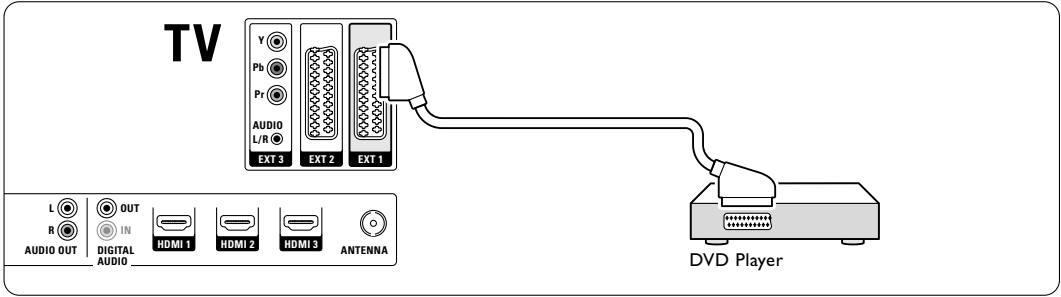

7.3.2 DVD Recorder or Digital Receiver

Use a scart cable and 2 antenna cables.

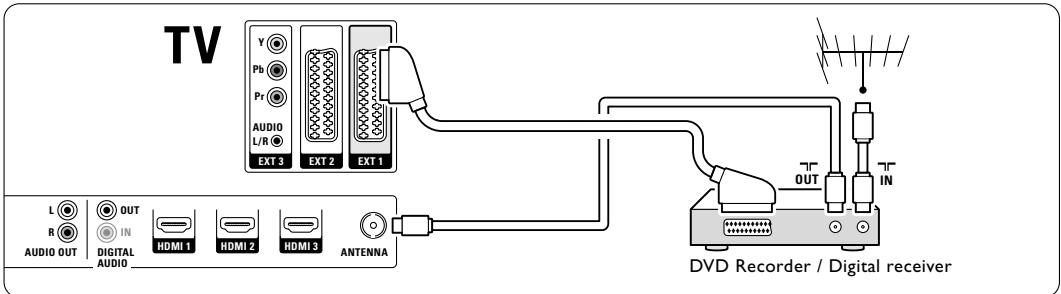

7.3.3 DVD Recorder and Digital Receiver

Use 3 scart cables and 3 antenna cables.

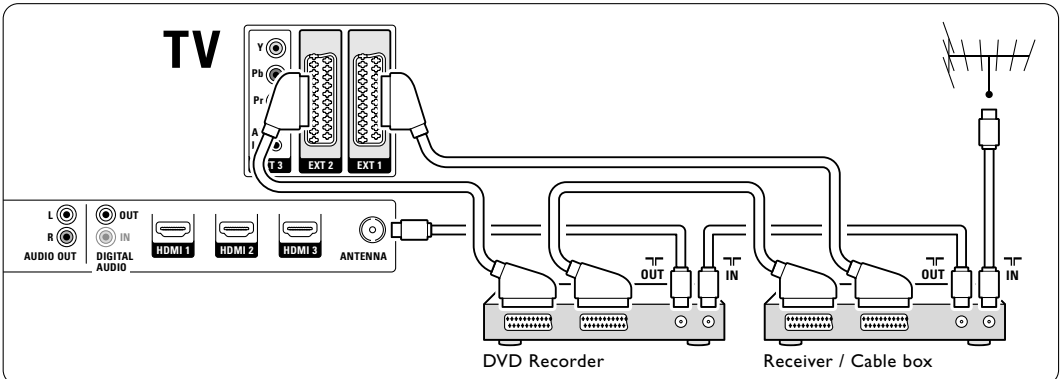

7.3.4 DVD Recorder and Home Theatre System

Use a scart cable, 2 antenna cables and 1 digital audio (cinch) cable.

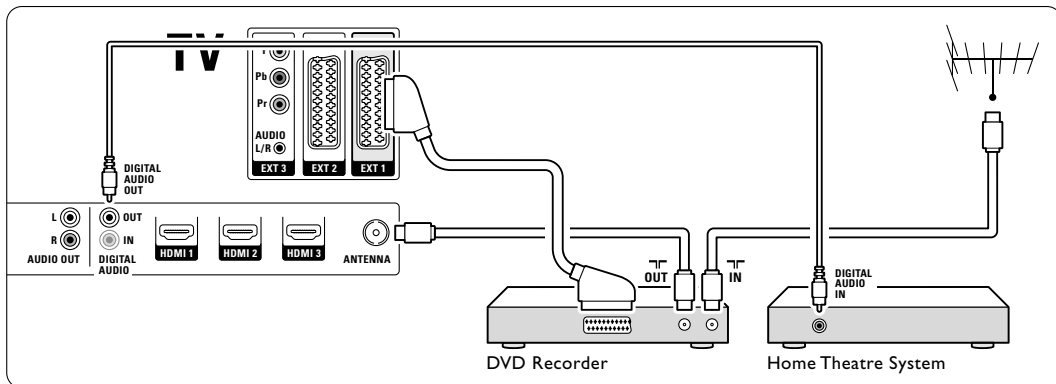

7.3.5 DVD Recorder and DVD Home Theatre System

Use 2 scart cables, 2 antenna cables and 1 digital audio (cinch) cable.

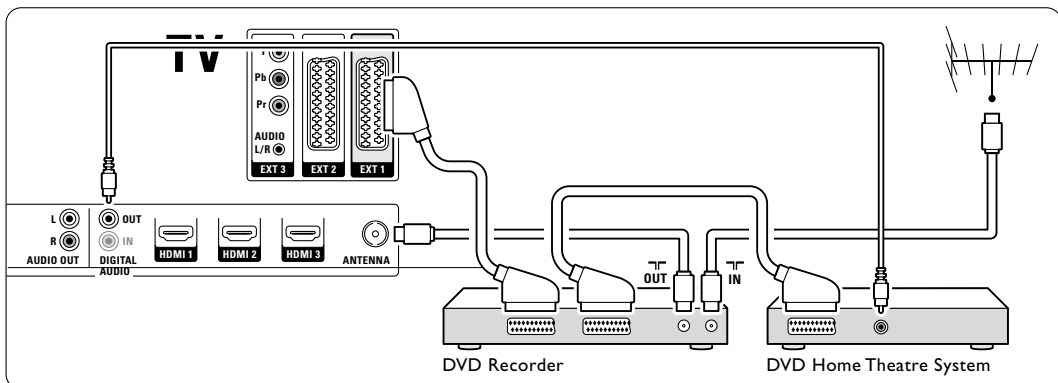

7.3.6 Satellite receiver

Use a scart cable and 2 antenna cables.

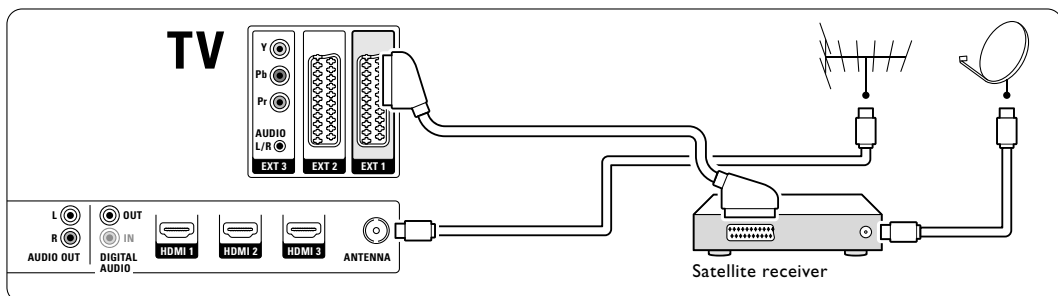

7.3.7 HD Digital receiver / HD satellite receiver

Use a HDMI cable and 2 antenna cables.

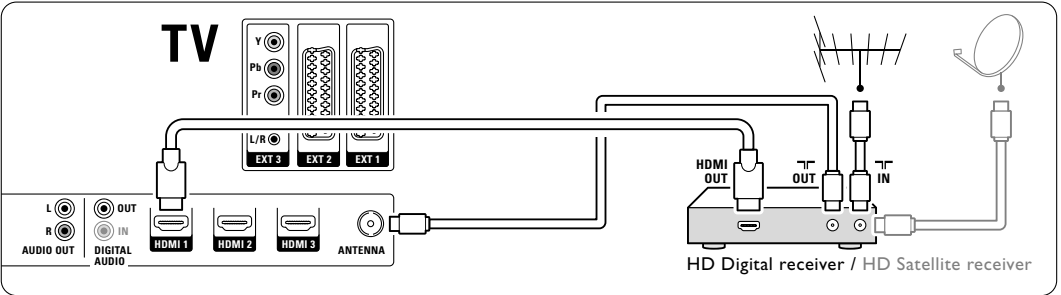

7.3.8 DVD-R, Home Theatre System and Digital receiver

Use 3 scart cables, 3 antenna cables and 1 audio (cinch) cable.

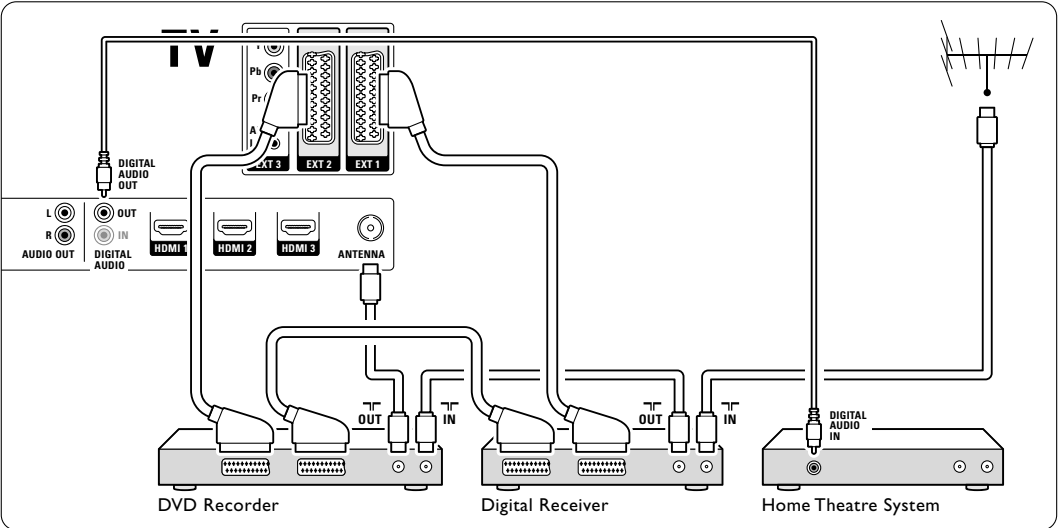

7.3.9 Blu-ray Disc player

Use a HDMI cable.

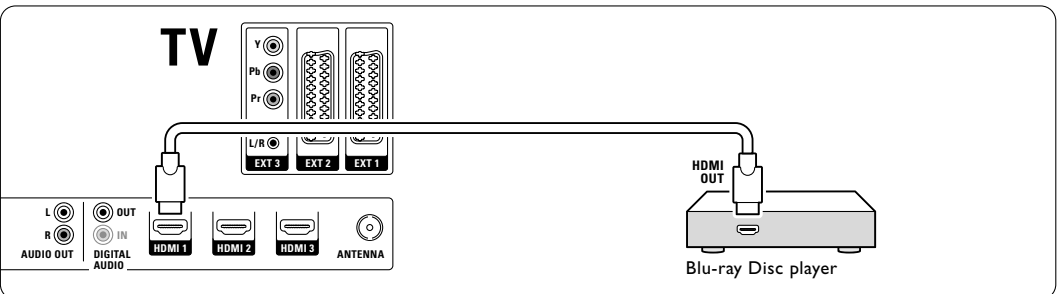

7.3.10 Game console

The most practical connection for a game console is at the side of the TV. More qualitative connections are at the back of the TV.

Connected at the side of the TV

Use the Video and Audio L/R (cinch) connectors.

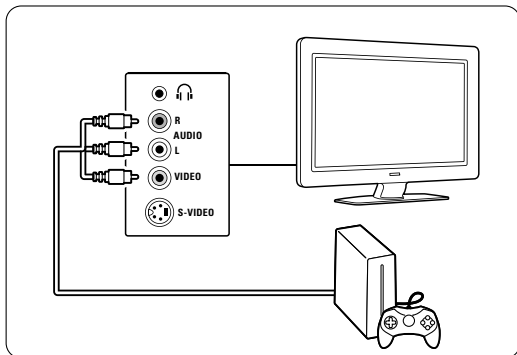

Connected at the back of the TV

Use a HDMI or the YPbPr (EXT3) input for HD quality.

7.3.11 Camcorder

The most practical connection for a camcorder is at the side of the TV. More qualitative connections are at the back of the TV.

Connected at the side of the TV

Use the Video and Audio L/R (cinch) connectors or use the S-Video and Audio L/R connectors.

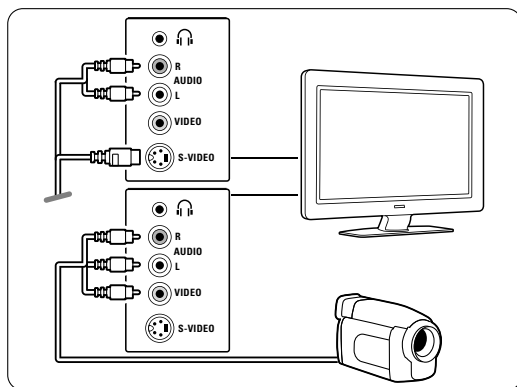

Connected at the back of the TV

Use a HDMI or the YPbPr (EXT3) input for HD quality.

7.3.12 Personal Computer

The best connection for a PC is at the back of the TV. A more practical connection, but only for viewing photos and films from your PC, is the connection at the side of the TV.

⚠ Caution

Before connecting the PC, set the PC monitor refresh rate to 60Hz.

Connected at the back of the TV

Use the DVI connection of your PC to connect to a HDMI connection of the TV. Use a HDMI to DVI cable or a HDMI-to-DVI-adaptor.

Add an audio cable with a Stereo mini jack for sound. Connect the Stereo mini jack to **EXT3** on the TV.

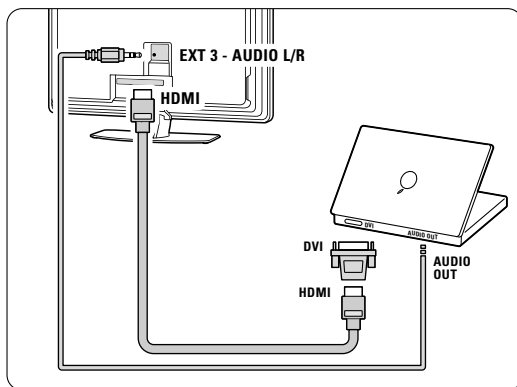

In the Connections menu, link this **EXT3** audio to the HDMI connector you are using. See section **7.4 Connections setup**.

Connected at the side of the TV

If your PC has no DVI connection, use the S-Video and Audio L/R (cinch) connectors at the side of the TV. This connection is only suited for applications like Windows Media Center or similar.

⚡ Tip

Change the TV picture format to **Unscaled** in the Picture format menu for maximal picture sharpness. See section **5.3.4. Widescreen picture format**.

For supported PC monitor resolutions, see section **8 Technical data**.

7.4 Connections setup

When all devices have been connected the TV needs to know what connections you have made, which device is connected to which connector.

7.4.1 Digital Audio In (if present)

If you use the Digital Audio In connection, assign this connection, in the menu, to the device from where the sound comes from.

- 1 Press **Menu** on the remote control and select TV menu > Installation > Connections > **Digital Audio In**.
- 2 Press navigation key right to enter the list.
- 3 Press navigation key up or down to select the connector used by the device.

Connections	DIGITAL AUDIO IN
...	None
EXT 3	EXT 1
HDMI 1	EXT 2
HDMI 2	EXT 3
HDMI 3	HDMI 1
Side	HDMI 2
AUDIO IN L/R	HDMI 3
DIGITAL AUDIO IN	Side

7.4.2 Audio In L/R

If you use the Audio In L/R connection, assign this connection, in the menu, to the device from where the sound comes from.

- 1 Press **Menu** on the remote control and select TV menu > Installation > Connections > **Audio In L/R**.
- 2 Press navigation key right to enter the list.
- 3 Press navigation key up or down to select the connector used by the device.

Connections	AUDIO IN L/R
EXT 2	None
EXT 3	EXT 3
HDMI 1	HDMI 1
HDMI 2	HDMI 2
HDMI 3	HDMI 3
Side	
AUDIO IN L/R	

7.4.3 Naming your devices

Name the connected devices for easy selection and best signal handling.

Assign the type of device (DVD, VCR, Game ...) to the connector you use for that device.

- 1 Press **Menu** on the remote control and select TV menu > Installation > Connections > **EXT1**.
- 2 Press navigation key right to enter the list.
- 3 Press navigation key up or down to select the type of device.
- 4 Press **Menu** to quit the menu.

Connections	EXT 1
EXT 1	None
EXT 2	DVD
EXT 3	Blu-ray
HDMI 1	HDD/DVDR
HDMI 2	HD rec.
HDMI 3	Game
Side	VCR
...	...

7.4.4 Decoder channels

Decoders that decode an antenna channel are connected to **EXT1** or **EXT2** (scart).

You have to assign the TV channel as a channel to be decoded. Then assign the connection where the decoder is connected.

- 1 Press **Menu** on the remote control and select TV menu > Installation > Decoder > **Channel**.
- 2 Press navigation key right to enter the list.
- 3 Press navigation key up or down to select the channel to decode.
- 4 Press navigation key left and go back to select **Status**.
- 5 Press navigation key up or down to select the connector used by the decoder.
- 6 Press **Menu** to quit the menu.

7.5 Preparing for digital services

Scrambled digital TV channels can be decoded with a Conditional Access Module (CAM) and a Smart card provided by a digital TV service operator. The CAM may enable several services depending on the operator you choose (e.g. Pay TV).

Contact your digital TV service operator for more information and terms.

7.5.1 Insert a Conditional Access Module - CAM

⚠ Warning

Switch off your TV before inserting a CAM. Look on the CAM for the correct inserting direction. Inserting the module incorrectly may damage the CAM and your TV.

- 1 Gently insert the CAM into the **Common Interface** slot at the back of your TV as far as it will go.
- 2 Leave the CAM in the Common Interface slot permanently.

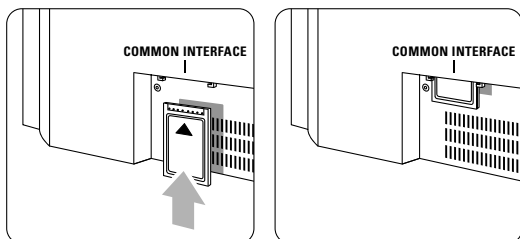

It may take a few minutes before a CAM is activated. Removing the CAM will deactivate the digital TV service.

7.5.2 Common interface menu

From this menu you access the CAM service you have installed. The applications and their function, the content and the messages on screen come from the CAM service provider.

- 1 Press **Menu** on the remote control and select TV menu > Features > **Common interface**. This menu option is available when a CAM is inserted and has made contact with the provider.

8 Technical data

Picture / Display

- Display type: LCD Full HD W-UXGA
- Panel resolution: 1920x1080p
- Perfect Pixel HD picture enhancement
- 1080p 24/25/30/50/60Hz processing
- 100 Hz Clear LCD

Supported display resolutions

- Computer formats

Resolution	Refresh rate
640 × 480	60Hz
800 × 600	60Hz
1024 × 768	60Hz
1280 × 768	60Hz
1360 × 768	60Hz
1920 × 1080i	60Hz
1920 × 1080p	60Hz
- Video formats

Resolution	Refresh rate
480i	60Hz
480p	60Hz
576i	50Hz
576p	50Hz
720p	50Hz, 60Hz
1080i	50Hz, 60Hz
1080p	24Hz, 25Hz, 30Hz
1080p	50Hz, 60Hz

Tuner / Reception / Transmission

- Antenna input: 75ohm coaxial (IEC75)
- TV system: DVD COFDM 2K/8K
- Video playback: NTSC, SECAM, PAL
- DVD: DVB Terrestrial
(see selected countries on the TV typeplate)

Dimensions and weights (approx.)

TV model	42PFL9900D/10
- width	1121 mm
- height	715 mm
- depth	125 mm
- weight	30 kg
TV + stand	
- width	1121 mm
- height	780 mm
- depth	256 mm
- weight	33 kg

Sound

- Sound system:
 - Virtual Dolby Digital
 - BBE

Multimedia

- Connections: USB
- Playback formats: MP3, LPCM, Slideshow (.alb) JPEG.

Remote control

- Type: RC4490
- Batteries: 3 Size AAA- LR03 type

Connectivity

- EXT1 (scart): Audio L/R, CVBS in/out, RGB
- EXT2 (scart): Audio L/R, CVBS in/out, RGB, S-video in/out
- EXT3: Y Pb Pr, Audio L/R in (mini jack)
- HDMI 1 In
- HDMI 2 In
- HDMI 3 In
- HDMI-control 1.3a
- Analog Audio L/R out - display synchronised
- Digital Audio in (coaxial-cinch-S/PDIF) (if present)
- Digital Audio out (coaxial-cinch-S/PDIF) - display synchronised
- Side: Audio L/R in, Video (CVBS) in, S-Video Headphone out (stereo mini jack), USB

Power

- Mains power: AC 220-240V (±10%)
- Power and standby power consumption:
See technical specification on www.philips.com
- Ambient temperature: 5°C - 35°C

Specifications are subject to change without notice.
For more specification details of this product see www.philips.com/support.

9 Troubleshooting

Television and remote control

The TV does not switch on

- Verify the mains cord connection.
- Verify if the batteries of the remote control are flat or weak. Verify their + / - orientation. You can use the keys on the TV to switch the TV on.
- Unplug the mains cord, wait for one minute and plug in the mains again.

The TV does not react on the remote control

- Verify if the batteries of the remote control are not empty or weak. Verify their + / - orientation.
- Clean the remote control and TV sensor lens.
- Use the side control keys to change some of the basic settings of picture and sound.
 - 1 Press **Volume** - and + to adjust the volume.
 - 2 Press **Program/Channel** - and + to go through the channels marked as favourites.
 - 3 Press **Menu** to show the main menu. Press **Program/Channel** - and + to select and adjust picture and sound menu items.

The red light on the TV blinks

- Unplug the mains cord for half a minute and insert it again. Verify if there is enough space for ventilation. Wait until the TV has cooled down. When the TV does not restart to standby and the blinking occurs again, call our Customer Support Centre.

You forgot your code to unlock Child lock

- See section **5.8.3 Set code / Change code**.

Wrong language in the TV menu ?

Follow these steps to change the language.

- 1 Press **Menu** on the remote control.
- 2 Press navigation key right.
- 3 Use navigation down to highlight the third line.
- 4 Press navigation key right three times.
- 5 Press navigation key up or down to select your language.
- 6 Press **OK**.
- 7 Press **Menu** to quit the menus.

TV channels

Some TV channels are gone

- Verify if the correct channel list is chosen.
- A channel could be uninstalled in the **Rearrange** menu.

No digital channels found during installation

- Verify if the TV supports DVB-T in your country. See the list of countries on the TV typeplate.

Picture

There is no picture

- Verify if the antenna is connected properly.
- Verify if the correct device is selected.

The sound is on, but there is no picture

- Verify the contrast or brightness setting in the menu.

The TV picture is poor

- Verify if the antenna is connected properly.
- Loudspeakers, non-earthed audio devices, neon lights, high buildings or mountains can influence the picture quality. Try to improve the picture by changing the antenna direction or place devices away from the TV.
- Verify if the correct TV system is chosen in the Manual installation menu.
- If only a certain channel is poor, try to fine tune this channel in the **Fine tune** menu. See section **6.2.3**.

The picture has poor colour

- Verify the colour settings in the Picture menu. Select any of the Reset to standard settings in the **Reset to standard** menu. See section **5.3.2**.
- Verify the connections and cables of the connected devices.

The TV did not remember my settings when I switch back on

- Verify if the TV is set to **Home** in the TV menu > Installation > Preferences > **Location** menu.

The picture does not fit the screen, it is too big or too small

- Select a more fitting picture format in the Picture format menu. See section **5.3.4 Widescreen picture format**.
- Name your connected device in the Connections menu to obtain the best signal handling. See section **7.4.3 Naming your devices**.

The picture position on screen is not correct

- Some picture signals from some devices do not fit the screen correctly. You can shift the picture with the navigation key on the remote control. Check the signal output of the device.

Sound

There is a picture but no sound

- Verify the volume is not set to 0.
- Verify the sound has not been muted with the  key.
- Verify if all cables are connected properly.
- If no sound signal is detected, the TV automatically switches off the sound. This is proper operation and does not indicate malfunction.

The sound is poor

- Verify if the sound is set to Stereo.
- Verify the Equalizer settings.
- Select any of the Reset to standards settings in the **Reset to standard** menu. See section 5.3.2.

The sound comes from one speaker only

- Verify if the Balance is not set to extreme left or right.

HDMI connections

Trouble with devices connected with HDMI

- The HDMI - HDCP procedure might take a few seconds before the TV shows the picture from a device.
- If the TV does not recognise the device and the screen shows no picture, try switching from one device to another and back again to restart the HDCP procedure.
- If sound interruptions occur persistently, see the user manual of the device to verify the output settings. If that does not help, connect an additional audio cable.
- If an HDMI-to-DVI adaptor is used, verify if an additional audio connection is in place to complete the DVI connection.

USB connection

The TV does not show the USB device content

- Set your device (camera) to 'Mass Storage Class' compliant.
- The USB device may need specific driver software. Unfortunately this software can not be downloaded to your TV.

I can not see my files in the Multimedia menu.

- Not all audio and picture files are supported. See section 8 **Technical data**.

Audio and picture files do not playback smoothly

- The transfer performance of the USB device limits the transfer rate.

Personal computer

The PC display on my TV is not stable or is not synchronised

- Verify if the correct resolution mode is selected on your PC. See section 8 **Technical data**.

If your problem is not solved

Switch your TV off and on again. If the problem is not solved, call the Customer Support Centre or consult our website www.philips.com/support.

See the Customer Support Centre telephone numbers on the last page of this user manual.

Please, have the TV Model and Product Number ready before you call.

You can find these numbers on the packaging label or on the typelabel on the back and bottom of the TV.

Warning

Never try to repair the TV yourself.

10 Index

100 Hz Clear LCD 20

A

Active Control 20
Ambilight
 menu / settings 23
 modes 23
Analogue
 manual installation 35
 TV channels 34
Antenna
 cable 9
 connect 9
 with devices 37
Auto format 21
Automatic installation 34
Auto surround 22
Automatic Volume Leveler 22

B

Balance
 sound 22
Batteries 3,9
Blacklevel 20
Blu-ray 37,38,42
Brightness 20
 ambilight 23

C

CA module 37,45
Cable
 HDMI 38
 Scart 39
 YPbPr 38
 S-Video 39
 Video 39
Camcorder 43
Camera (photo) 43
Care of the screen 3
Change code 27
Channel
 all channels list 25
 favourite list 25
 installation 34
 lock 27
 management 36
 previous 14
 rearrange 35

Channel
 store / install 35
Child lock 27
Clock 19
Code 27
Colour enhancement 20
Colour
 boost 23
 menu 20
 keys 4,14
Common interface (CAM)
 menu 45
 slot 37,45
Connection
 best 38
 overview 37
 set up 38,43
Contrast 20
Country
 selection 34
Custom colour 23
Custom lock 27
Custom tint 20

D

Decoder
 channel 44
Delta volume 22
Device
 connecting 38
 naming 44
 watch 11
Digital
 audio out 37
 subtitle language 28
 receiver 38
 text services 24
 test reception 36
Dual I/II 22
Dual screen 14
DVB-T 5
DVD
 connect 40
 playback 11
 player 40
 recorder 40
Dynamic contrast 20

E

Electronic Programme Guide 26
Equalizer 22
External 1,2,3 (EXT) 37

F

Factory settings 36
Favourite channel lists 25
Fine tune 35

G

Game console 43

H

HDCP 38
HDMI
 connection 37
HD digital receiver 42
HD natural motion 20
Headphone
 connect 4,37
 volume 22
Hearing impaired 34
Home
 location 47
Home theatre system 41
Hue 20

I

Installation
 automatic 34
 manual 35
 menu 34
 update 36

K

Kensington Security Slot 5
Key(s)
 colour 14
 on TV 4
 on remote control 4,14

L

Language
 menu 34
 audio 22
 subtitle 28
Locks 27

M

Mains cord 10
Menu key 17
Mono 22
Movie expand 21
MPEG artefact reduction 20
Music 30
Mute key 14

N

Naming devices 44
Noise reduction 20

O

OK key 14
On timer 27

P

Perfect Pixel HD 20
Personal Computer
 connect 43
 display resolutions 46
Photo viewer 29
Picture
 format 20
 menu 20
Position the TV 5
Power 10
Programme up/down 14

Q

Quick access menu 19

R

Radio channel 31
Rearrange channels 35
Recorder 40
Recycling 3
Remote control
 batteries 9
 overview 14
Rename 35
Reorder 35
Reset to standards 19

S

Safety 3
Satellite receiver 41
Scart connection 38
Screen cleaning 3
Search
 channels 32
 teletext pages 21

Set code 27
Settings assistant 19
Sharpness 20
Sleeptimer 27
Software update 31
Sound
 menu 22
 surround mode 22
Standby 14,27
Super zoom 21
Stationary images 3
Stereo 22
Subtitle 28
 shift 21
Switch on 10

T

Table of Pages T.O.P 23
Technical data 46
Teletext 23
 teletext 2.5 24
 digital 24
 dual screen 23
 menu 24
 page 23
Time zone 34
Timers 27
Tint 20
Troubleshooting 47
TV settings menu 19

U

USB
 connector 37
 device 29
 photo viewer 29

V

VCR
 connect 40
Video cable 39
Video formats 46
Volume
 key 14
 menu 22

W

Whitepoint 20
Widescreen picture format 21

Y

YPbPr 38