

# PHILIPS

## Television

### Quick Start Guide

8217 series

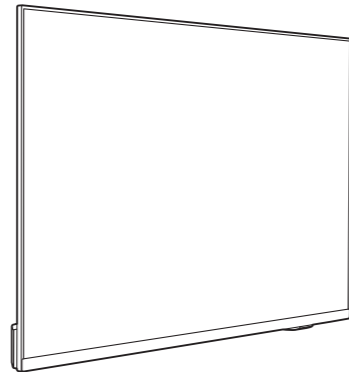

43"/50"/55"  
65"

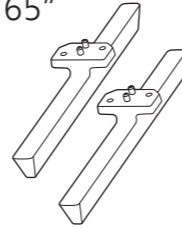

70"

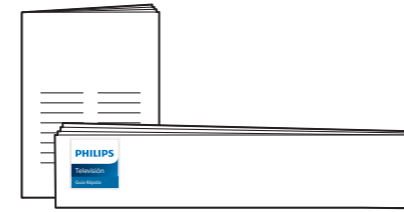
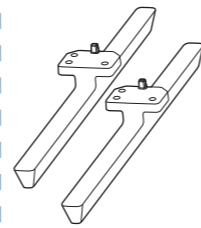

• 43"/50"/55"/65": x4  
• 70": x6

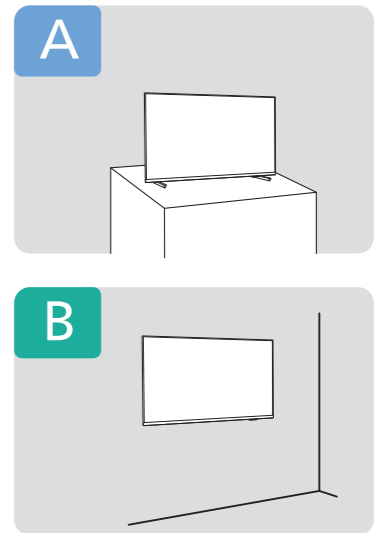
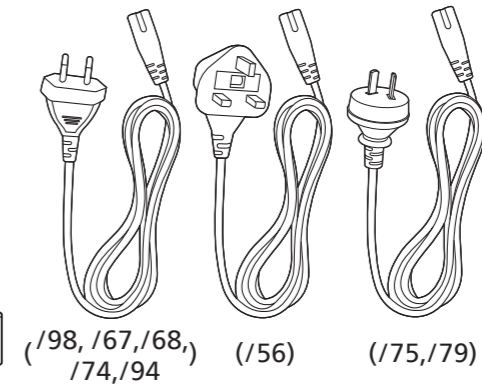
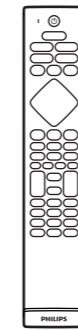

A

43"/50"/55"

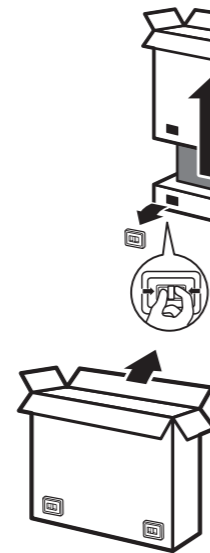
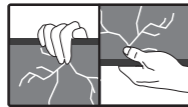
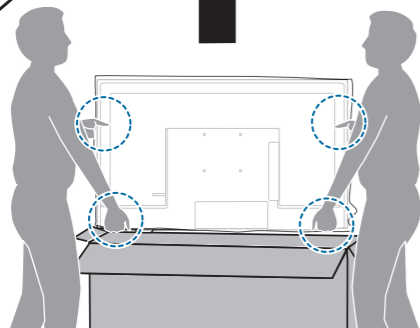
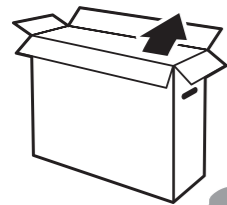

65"/70"

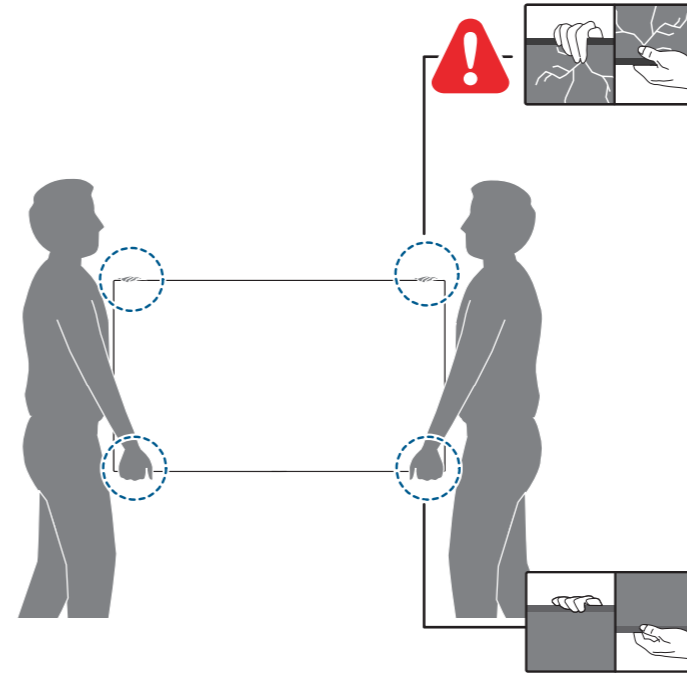

1

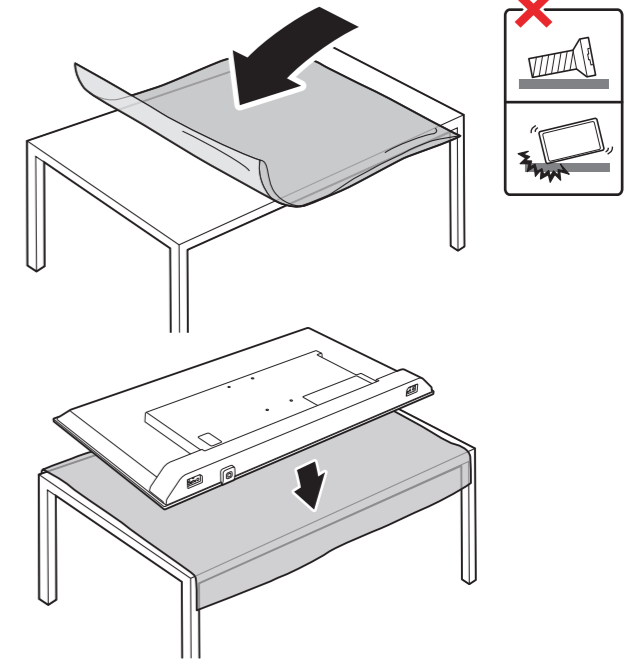

2

R + L

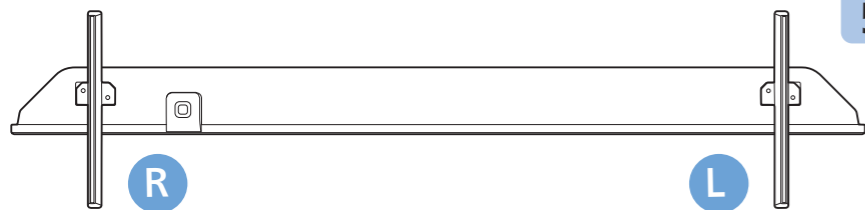

43"/50"  
55"/65"

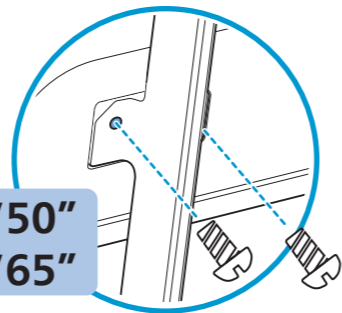

70"

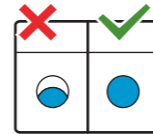
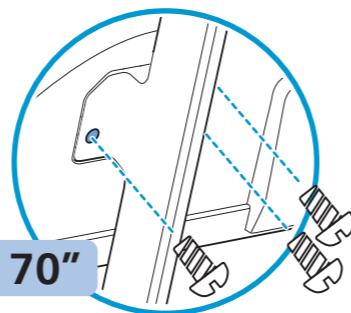

3

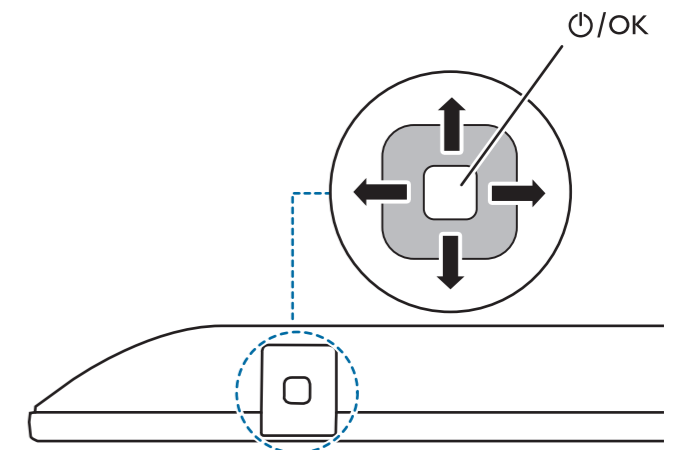
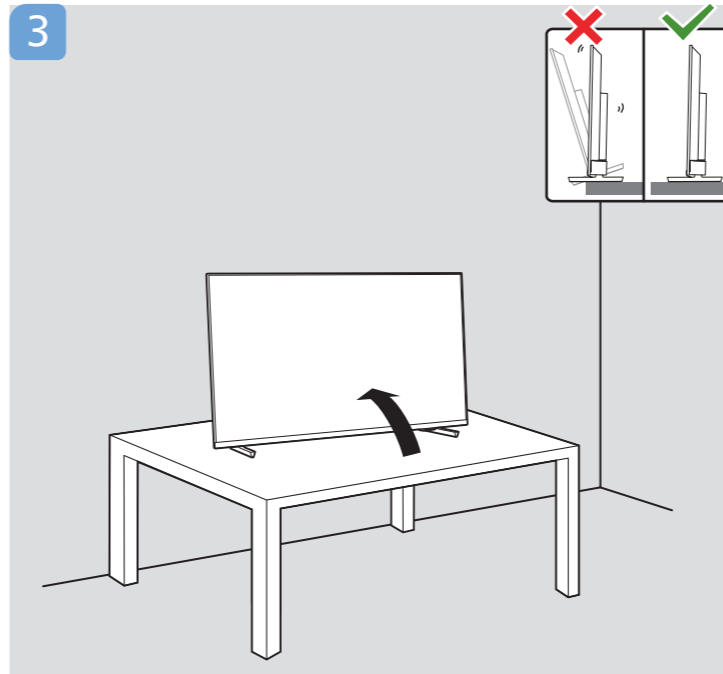



**English** Read the safety instructions.

**Bahasa Malaysia** Baca arahan Keselamatan.

**Bahasa Indonesia** Baca petunjuk keselamatan.

**Deutsch** Lesen Sie die Sicherheitshinweise.

**Français** Lisez les consignes de sécurité.

**Português** Leia as instruções de segurança.

**ภาษาไทย** โปรดอ่านคำแนะนำด้านความปลอดภัย

**Tiếng Việt** Hãy đọc chỉ dẫn an toàn.

**简体中文** 请阅读安全说明。

**العربية** قراءة تعليمات السلامة.



Register your product and get support at [www.philips.com/TVsupport](http://www.philips.com/TVsupport)

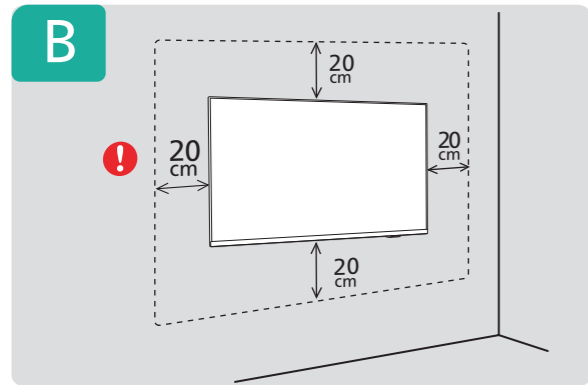
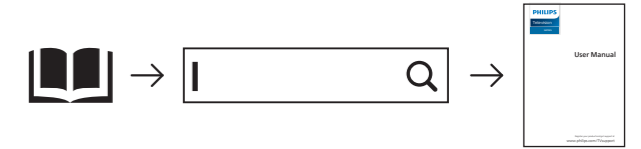

**Wall Mount dimensions (x, y)**



- 43" 100x200mm M6 (L: 8mm~11mm) 108 cm
- 50" 100x200mm M6 (L: 10mm~20mm) 126 cm
- 55" 200x300mm M6 (L: 10mm~20mm) 139 cm
- 65" 300x300mm M6 (L: 20mm~25mm) 164 cm
- 70" 300x300mm M8 (L: 10mm~20mm) 177 cm

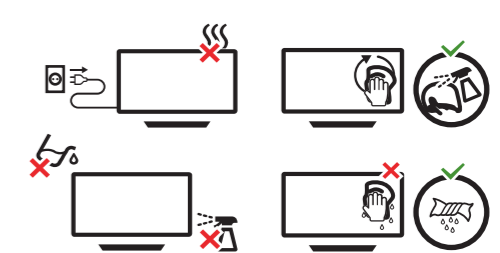
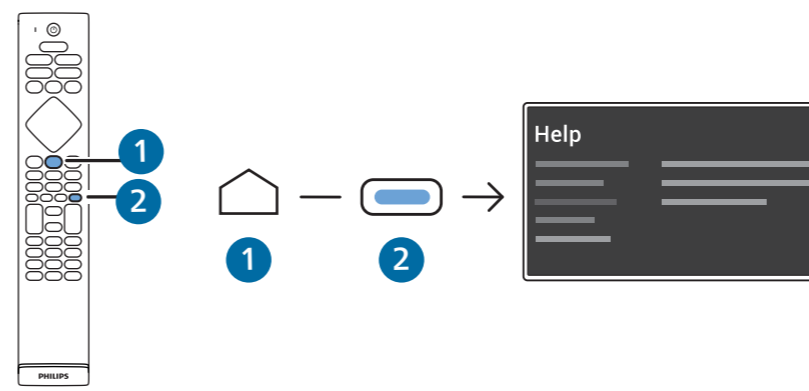
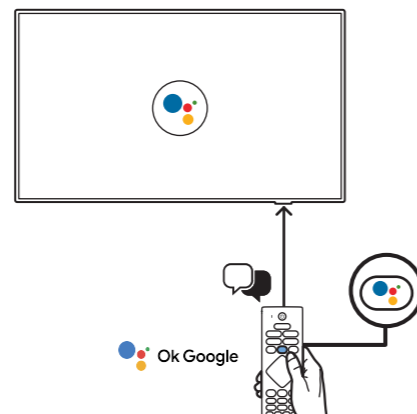
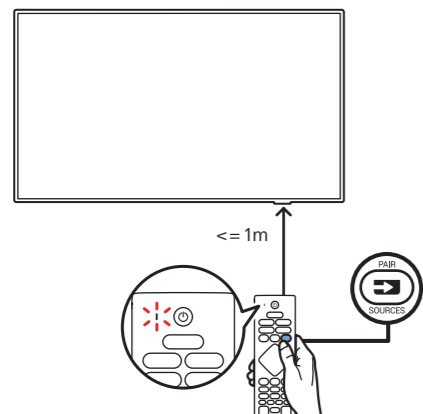
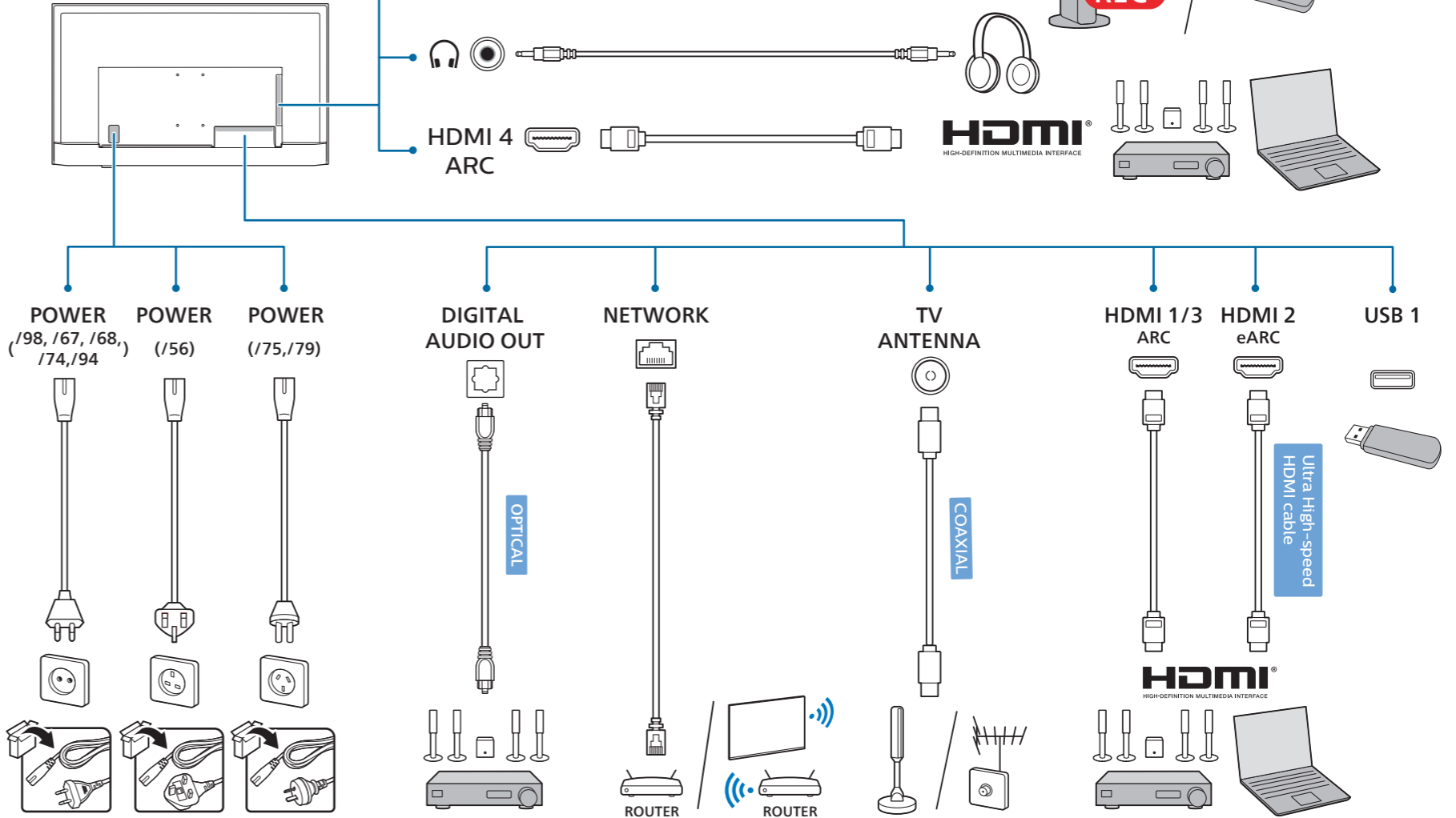
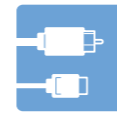
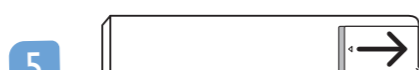
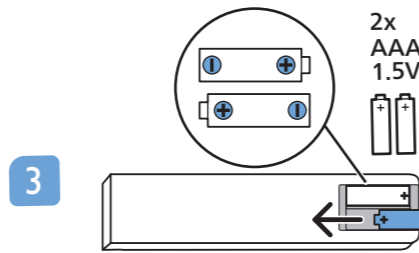
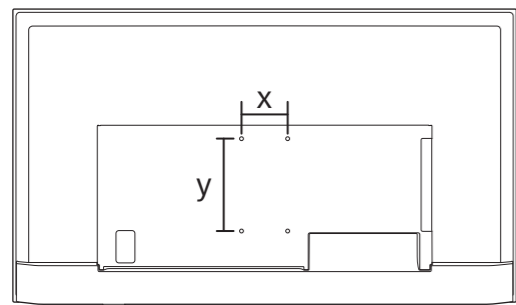

All registered and unregistered trademarks are property of their respective owners. Specifications are subject to change without notice. Philips and the Philips' shield emblem are trademarks of Koninklijke Philips N.V. and are used under license from Koninklijke Philips N.V. This product has been manufactured by and is sold under the responsibility of TP Vision Europe B.V., and TP Vision Europe B.V. is the warrantor in relation to this product. 2022 © TP Vision Europe B.V. All rights reserved. [www.philips.com/welcome](http://www.philips.com/welcome)