

Registre su producto y obtenga asistencia en
www.philips.com/TVsupport

32PHG4503/77
43PFG5503/77

PHILIPS



English Read the safety instructions.

Español Lea la información de seguridad.

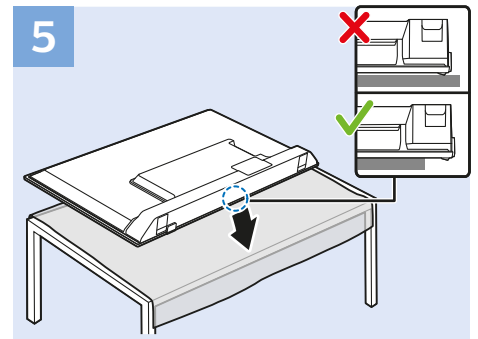
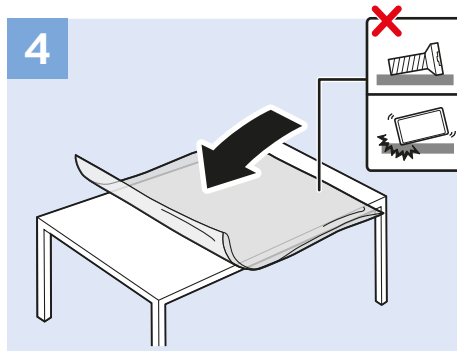
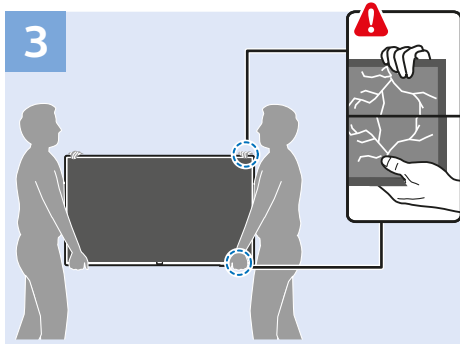
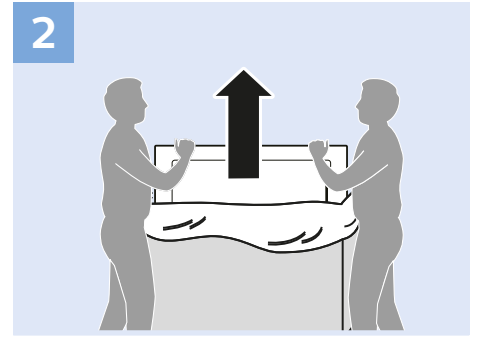
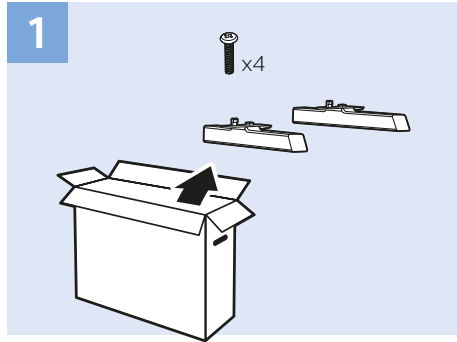
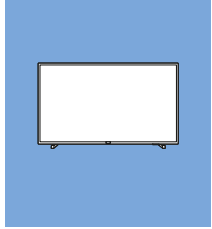

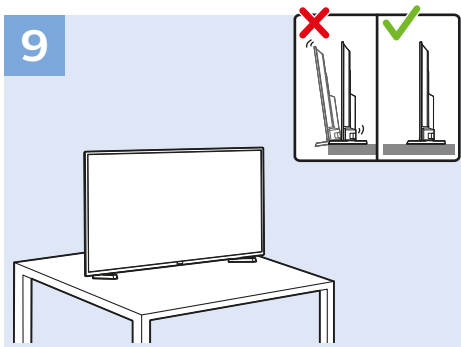
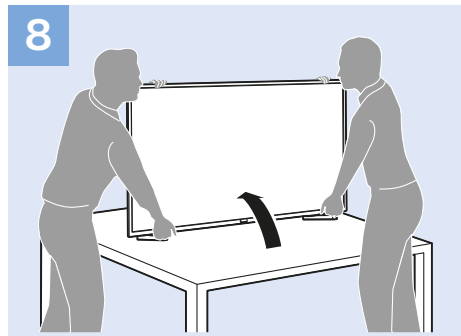
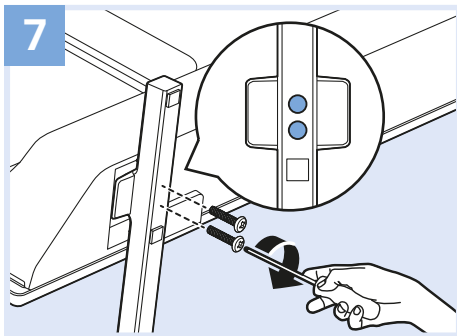
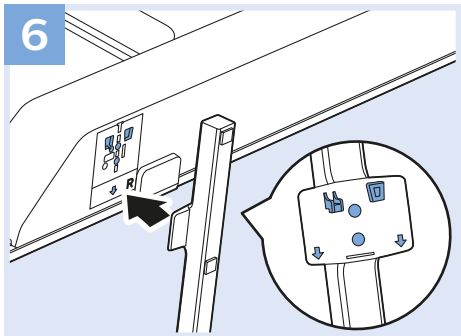

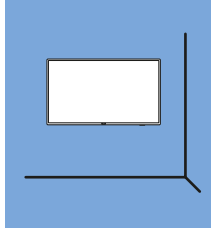

32"

VESA (x) 100 mm M4



80 cm

43"

VESA (x, y) 200x100 mm M6



108 cm

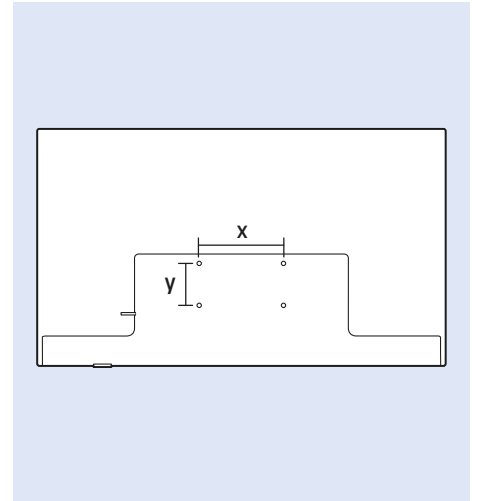
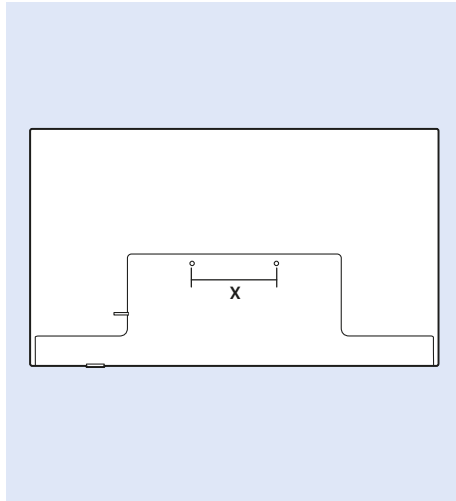

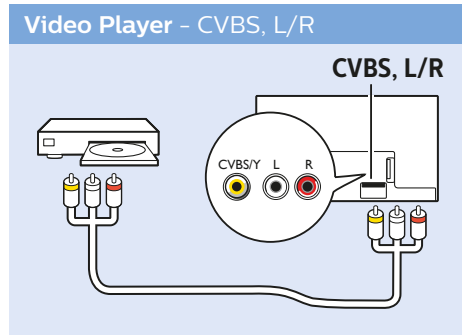
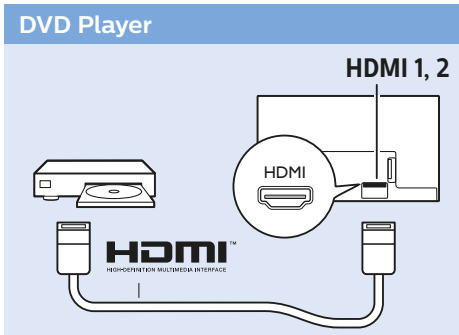
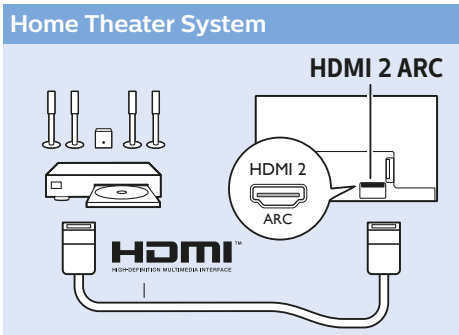
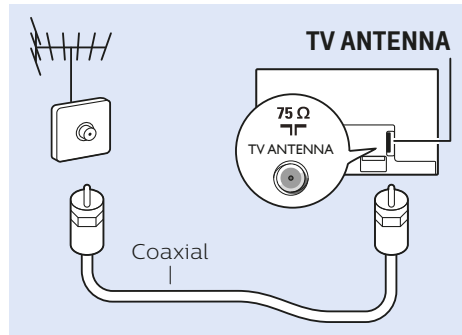
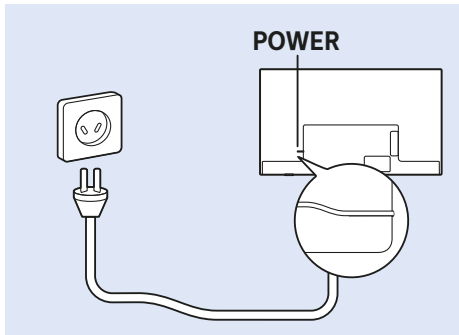
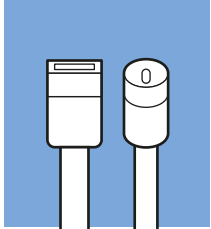

Digital Audio System - HDMI ARC

HDMI 2 ARC

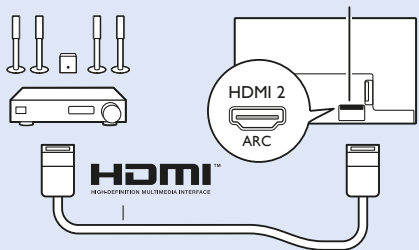

Digital Audio System - OPTICAL

SPDIF OUT

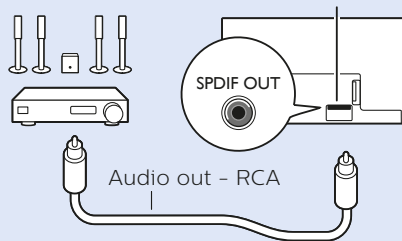

Computer - HDMI

HDMI 1, 2

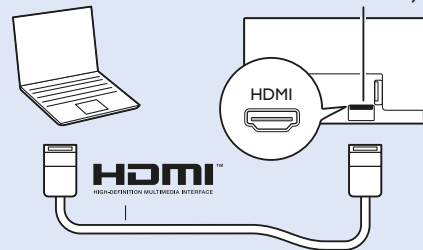

Headphones

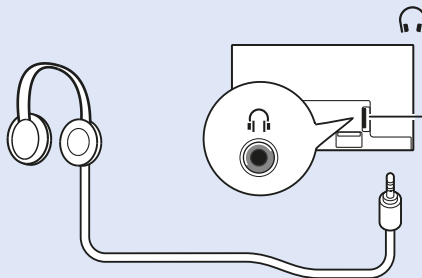
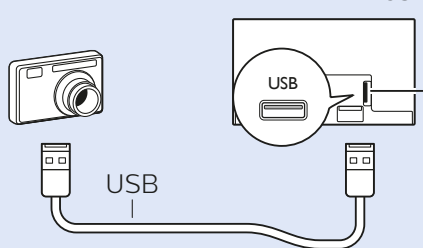

Photo Camera

USB



USB Flash Drive

USB

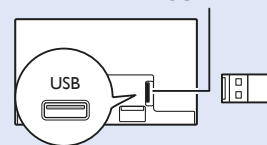

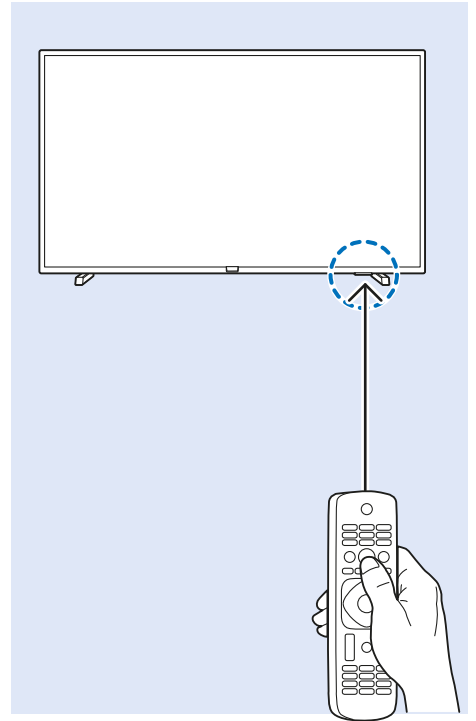
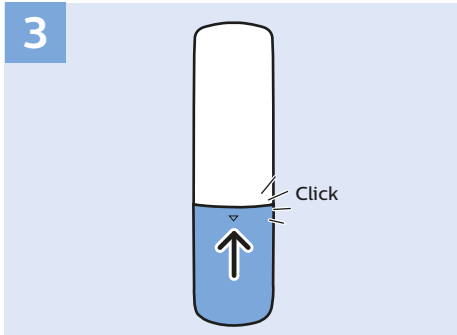
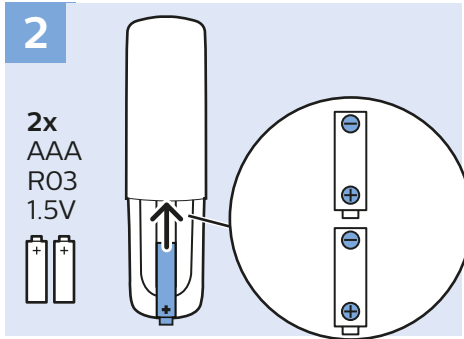
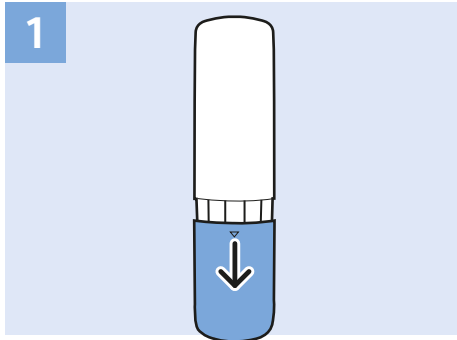
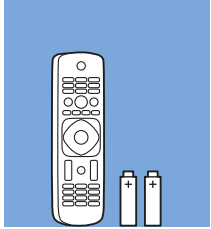

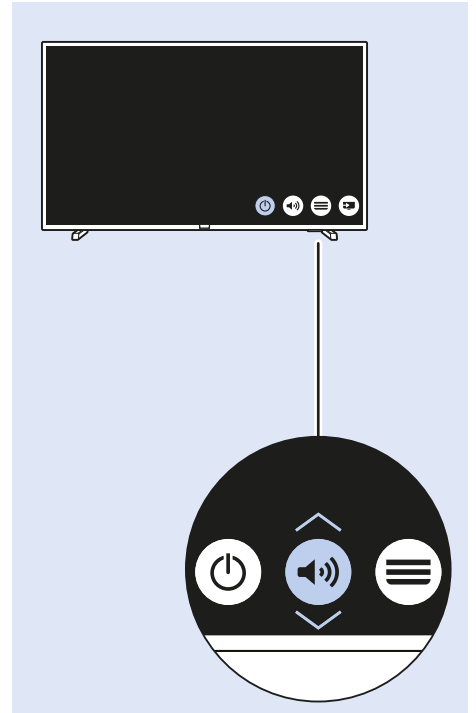
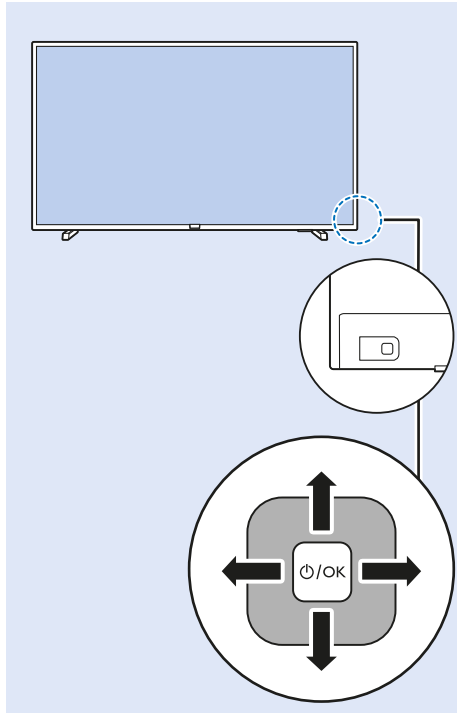
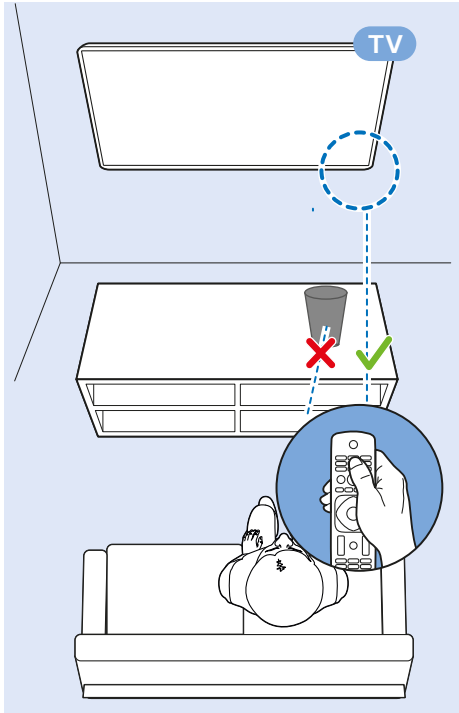

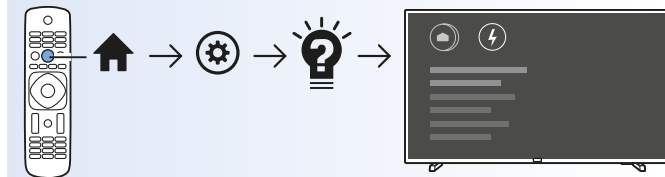

www.philips.com/TVsupport



PHILIPS



All registered and unregistered trademarks are property of their respective owners.
Specifications are subject to change without notice.
Philips and the Philips' shield emblem are trademarks of Koninklijke Philips N.V.
and are used under license from Koninklijke Philips N.V.
2018 © TP Vision Europe B.V. All rights reserved.

[philips.com](https://www.philips.com)