

**PHILIPS**

Television

6916 Series

# User Manual

39PHT6916

Register your product and get support at  
[www.philips.com/TVsupport](http://www.philips.com/TVsupport)

---

# Contents

<b>1 What's new</b>	<b>4</b>	<b>9 Connect your Android TV</b>	<b>22</b>
1.1 Home and channels	4	9.1 Network and Internet	22
1.2 Apps and Live TV	4	9.2 Google Account	23
<b>2 Setting Up</b>	<b>5</b>	9.3 Home Screen	23
2.1 Read Safety	5	<b>10 Apps</b>	<b>25</b>
2.2 TV Stand and Wall Mounting	5	10.1 About Apps	25
2.3 Tips on Placement	5	10.2 Google Play	25
2.4 Power Cable	5	10.3 Start or Stop an App	26
2.5 Antenna Cable	5	10.4 Settings for Apps	26
<b>3 Remote Control</b>	<b>6</b>	10.5 Manage Apps	27
3.1 Key Overview	6	<b>11 Settings</b>	<b>28</b>
3.2 Pair Your Remote Control to TV	7	11.1 TV options	28
3.3 Voice Search	7	11.2 Picture Settings	28
3.4 IR Sensor	7	11.3 Sound Settings	29
3.5 Batteries	7	11.4 Power Settings	30
3.6 Cleaning	8	11.5 Advanced Options	30
<b>4 Switching On and Off</b>	<b>9</b>	11.6 Other settings	31
<b>5 Channels</b>	<b>10</b>	11.7 Reset TV Settings	32
5.1 About Channels and Switch Channels	10	11.8 Restart	32
5.2 Channel Lists	10	11.9 Clock, Region, and Language Settings	32
5.3 Watching channels	10	11.10 Accessibility Settings	33
5.4 Favourite Channels	11	<b>12 Videos, Photos, Music &amp; Text</b>	<b>34</b>
5.5 Text / Teletext	12	12.1 From a USB Connection	34
5.6 Interactive TV	12	12.2 Play your Videos	34
<b>6 Channel Installation</b>	<b>14</b>	12.3 View your Photos	34
6.1 Antenna Installation	14	12.4 Play your Music	35
6.2 Update Channels	14	12.5 View your Text	35
6.3 Reception Quality	14	<b>13 TV Guide</b>	<b>36</b>
6.4 Analog Manual Scan	14	13.1 What You Need	36
6.5 Channel Scan or Store Type	14	13.2 TV Guide Data	36
6.6 Channel Skip	14	<b>14 Recording and Pause TV</b>	<b>37</b>
6.7 Channel Move	15	14.1 Recording	37
6.8 Channel Sort	15	14.2 Pause TV	37
6.9 Channel Edit	15	<b>15 Smartphones and Tablets</b>	<b>39</b>
6.10 Analog Channel Fine Tune	15	15.1 Google Cast	39
6.11 Clear Channel List	15	<b>16 Netflix</b>	<b>40</b>
<b>7 Connect Devices</b>	<b>16</b>	<b>17 Amazon Prime Video</b>	<b>41</b>
7.1 About Connections	16	<b>18 Software</b>	<b>42</b>
7.2 Home Theatre System - HTS	17	18.1 Update Software	42
7.3 Video Device	17	18.2 Software Version	42
7.4 Audio Device	18	18.3 Open Source Licenses	42
7.5 USB Hard Drive	18	<b>19 Specifications</b>	<b>43</b>
7.6 USB Flash Drive	19	19.1 Environmental	43
<b>8 Bluetooth®</b>	<b>21</b>	19.2 Power	43
8.1 What You Need	21	19.3 Operating System	43
8.2 Pairing a Device	21	19.4 Reception	43
8.3 Select a Device	21	19.5 Display Type	43
8.4 Rename a Device	21	19.6 Display Input Resolution	43
8.5 Remove a Device	21	19.7 Connectivity	44

19.8 Sound	44
19.9 Multimedia	44
<b>20 Help and Support</b>	<b>45</b>
20.1 Register your TV	45
20.2 Troubleshooting	45
20.3 Online Help	47
20.4 Support and Repair	47
<b>21 Safety and Care</b>	<b>48</b>
21.1 Safety	48
21.2 Screen Care	49
<b>22 Terms of Use</b>	<b>50</b>
<b>23 Copyrights</b>	<b>51</b>
23.1 HDMI	51
23.2 HEVC	51
23.3 Dolby Audio	51
23.4 DTS-HD	51
23.5 Wi-Fi Alliance	51
23.6 Kensington	51
23.7 Other Trademarks	51
<b>24 Disclaimer</b>	<b>53</b>
<b>Index</b>	<b>54</b>

# What's new

## Home and channels

### The Home launcher

Press **Home** on your remote control to get your new Android Home screen. From here you can decide what to watch by browsing entertainment options from app and live TV. Your Home has channels to let you discover great contents from your favourite apps. You can also add additional channels or find new apps to get more contents.

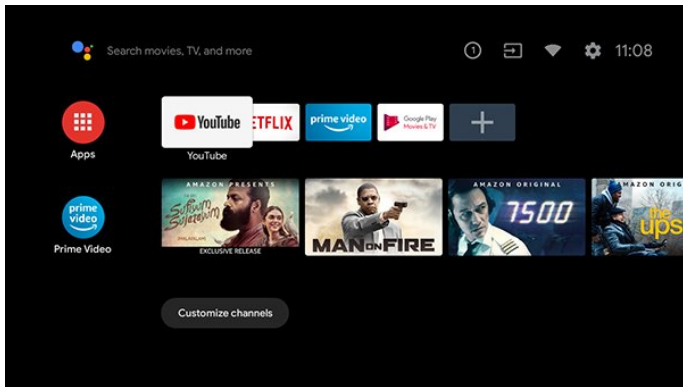

### “Play Next” channel

You can always know what to watch next from **Play Next** channel on the Home screen. Start watching from where you left off and get notifications about new episodes in the **Play Next** channel. Press and hold **Select** on a movie or TV show to add it directly to the **Play Next** channel.

### Accessing settings from Home

You can access **Settings** menu via the icon at the top right corner.

### Accessing MENU from Home

To open the quick menu with typical TV functions.

1. Press **SOURCES** and select TV source.
2. Press **MENU** to open the quick menu.

### Accessing USB flash drive from Home

To view the files from the USB flash drive, you need to add the MMP (MultiMediaPlayer) app to the Home page first. Press **Home**, clicking the **Apps** icon at the left end of the **Apps** row. You can add **MMP** apps from the **Apps** page.

### System bar on Home screen

The **System bar** on the top of Home screen contains following features.

- **Search button**: to trigger Google search with voice or text input.
- **Notifications**: to provide you the messages about

your Smart TV system.

- **Input source**: to launch the input source list and switch to any of the connected devices.
- **Settings**: to access all setting menu and adjust the TV settings.
- **Clock**: to indicate the system clock.

## Apps and Live TV

### Favourite Apps on the first row

You can find more apps in the **Apps** page which can be opened by clicking the **Apps** icon at the left end of the **Apps** row. You can also add more apps as favourite from the **Apps** page, such as the **Live TV** and **MMP** (MultiMediaPlayer).



# Setting Up

## 2.1

## Read Safety

Read the safety instructions first before you use the TV.

## 2.2

## TV Stand and Wall Mounting

### TV Stand

You can find the instructions for mounting the TV stand in the Quick Start Guide that came with the TV. In case you lost this guide, you can download it from [www.philips.com/TVsupport](http://www.philips.com/TVsupport).

Use the model number of the TV to look for the Quick Start Guide to download.

### Wall Mounting

Your TV is also prepared for a VESA-compliant wall mount bracket (sold separately).

Use the following VESA code when purchasing the wall mount . . .

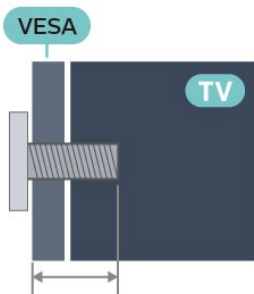

- 39PHx6916
- VESA MIS-F 200x200, M6 (Min.: 10mm, Max.:15mm)

#### Caution

Wall mounting the TV requires special skills and should only be performed by qualified personnel. The TV wall mounting should meet safety standards according to the TV's weight. Also read the safety precautions before positioning the TV. TP Vision Europe B.V. bears no responsibility for improper mounting or any mounting that results in accident or injury.

## 2.3

## Tips on Placement

- Position the TV where light does not shine directly on the screen.
- The ideal distance to watch TV is 2 to 5 times its diagonal screen size. When seated, your eyes should be level with the centre of the screen.
- When wall mounted, position the TV up to 15 cm away from the wall.

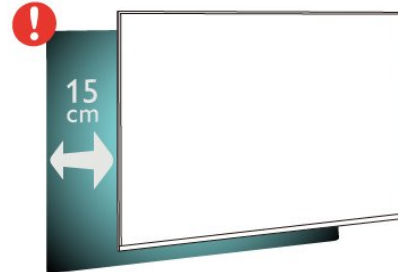

#### Note:

Please keep the TV away from dust-producing sources such as stoves. It is suggested to clean the dust regularly to avoid getting dust into the TV.

## 2.4

## Power Cable

- Make sure that the power plug, in the wall socket, is accessible at all times.
- When you unplug the power cable, always pull the plug, never pull the cable.

Although this TV has a very low standby power consumption, unplug the power cable to save energy if you do not use the TV for a long period of time.

## 2.5

## Antenna Cable

Insert the antenna plug firmly into the Antenna socket at the back of the TV.

You can connect your own antenna or an antenna signal from an antenna distribution system. Use an IEC Coax 75 Ohm RF antenna connector.

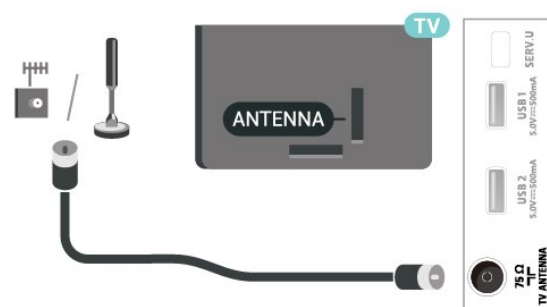

# Remote Control

## 3.1

### Key Overview

#### Top



#### 1 - Power (Standby / On)

To switch the TV on or back to Standby.

#### 2 - Voice microphone

#### 3 - MENU

To open the Quick Menu with typical TV functions.

#### 4 - AD / INFO

- Short press to access the Audio Description and toggle to switch on and off.
- Long press to open programme information.

#### 5 - SOURCES / PAIR

- To open or close the Sources menu.
- To pair the remote control to the TV.

#### 6 - Google Assistant™

- To launch the Google Assistant™.
- While Google Assistant™ is not supported, press to start voice search.

\* Note: Google Assistant™ is only available in selected countries.

#### 1 - OK key

To confirm a selection or setting. To open the channel list while watching TV.

#### 2 - Navigation keys

To navigate up, down, left or right.

#### 3 - Back

- To return to previous menu.
- To go back to the previous App/Internet page.

#### 4 - Playback and Record

- Play, to playback.
- Pause, to pause playback
- Stop, to stop playback
- Rewind, to rewind
- Fast forward, to go fast forward
- Record, to start recording

#### 5 - EXIT

- To return to previous menu.
- To go back to the previous App/Internet page.

#### 6 - Home

To open the Home menu.

#### 7 - Colour keys

Follow the on-screen instructions.

#### Bottom

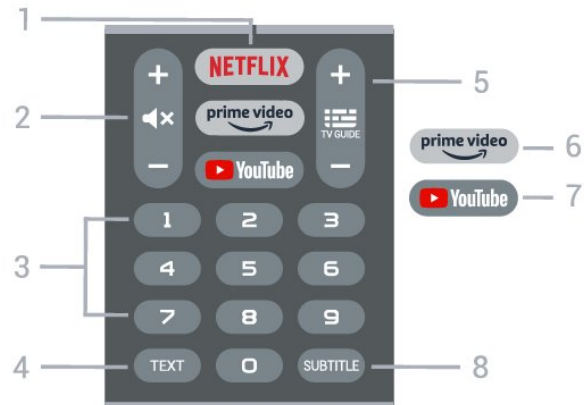

#### 1 - NETFLIX

To open the Netflix App directly. With the TV switched on or from standby.

- If you have a Netflix membership subscription, you can enjoy Netflix on this TV. Your TV must be connected to the Internet.
- To open Netflix, press NETFLIX to open the Netflix App. You can open Netflix immediately from a TV in standby.

[www.netflix.com](http://www.netflix.com)

#### 2 - Mute / Volume

Press in middle to mute the sound or to restore it. Press + or - to adjust the volume level.

#### 3 - Number keys

To select a channel directly.

#### Middle

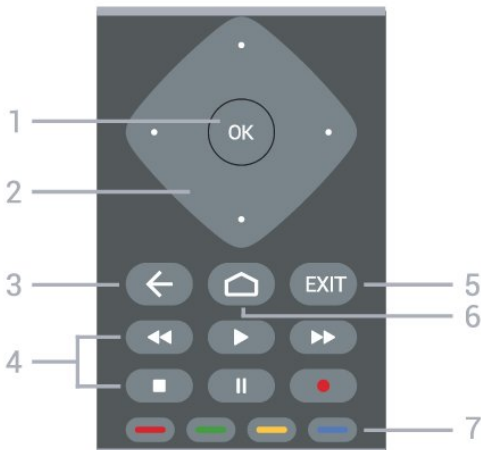

#### 4 - TEXT

To open or close Text/Teletext.

#### 5 - TV GUIDE / Channel

- Press in middle to open or close TV Guide.
- Press + or - to switch to the next or previous channel in the channel list. To open the next or previous page in Text/Teletext.

#### 6 - Amazon Prime Video

To launch the Amazon Prime Video App.

#### 7 - YouTube

To open the YouTube App directly.

#### 8 - SUBTITLE

To open Subtitle page.

---

### 3.2

## Pair Your Remote Control to TV

This remote control uses both Bluetooth® and IR (infrared) to send its commands to the TV.

- You can use this remote control via IR (infrared) for most operations.
- To use advanced operation like voice search and remote control keyboard, you need to pair (link) the TV with the remote control.

When you start the initial TV installation, the TV invites you to long press the **PAIR** key, and by doing so, the pairing will be done.

#### Note:

- 1 - Once the remote control has entered pairing mode successfully, the blue LED indicator ring around the microphone on the front side of the remote control starts blinking.
- 2 - The remote control must be kept close to the TV (within 1m distance) during pairing in order to ensure success.
- 3 - If the TV does not launch the voice control field when press **Google Assistant™**, pairing was unsuccessful.
- 4 - It is advisable to wait until the set has fully started up and launched all background processes before pairing mode is entered as the toast message containing further instructions may appear too late, thereby negatively impacting the pairing procedure.

#### Pairing again

If the pairing with the remote control was lost, you can pair the TV with the remote control again.

You can simply long press the **PAIR** key (approximate for 3 seconds) for pairing.

---

### 3.3

## Voice Search

You can search for videos, music or anything else on the Internet by simply using your voice. You can speak into the microphone on the remote control.

You need to pair the remote control to the TV before use voice search.

To use Voice...

- 1 - Press **Google Assistant™** on remote control, the blue light on the remote control lights up and the search field opens, the microphone is active.
- 2 - Speak out what you are looking for with clear pronunciation. You can speak for 10 seconds before the microphone switches off. It might take some time for the results to appear.
- 3 - In the list of search results, you can select the item you want.

---

### 3.4

## IR Sensor

The TV can receive commands from a remote control that uses IR (infrared) to send commands. If you use such a remote control, always make sure you point the remote control at the infrared sensor on the front of the TV.

#### Warning

Do not put any objects in front of IR sensor of the TV, it may block the IR signal.

---

### 3.5

## Batteries

If the TV does not react on a key press on the remote control, the batteries might be empty.

To replace the batteries, open the battery compartment on the back-bottom of the remote control.

- 1 - Slide the battery door in the direction shown by the arrow.
- 2 - Replace the old batteries with 2 type **AAA-1.5V** batteries. Make sure the + and the - ends of the batteries line up correctly.
- 3 - Reposition the battery door and slide it back until it clicks.

Remove the batteries if you are not using the remote control for a long time. Safely dispose of your old batteries according to the end of use directions.

For more information, in [Help](#), select [Keywords](#) and look up [End of use](#).

---

3.6

## Cleaning

Your remote control is treated with a scratch-resistant coating.

To clean the remote control, use a soft damp cloth. Never use substances such as alcohol, chemicals or household cleaners on the remote control.



---

# Switching On and Off

Make sure the TV is connected to the mains AC power. The indicator light at the bottom of the TV lights up.

## Switch on

Press **Power** on the remote control to switch the TV on. You can also press the small joystick key on the bottom of the TV to switch the TV on in case you can't find the remote control or its batteries are empty.

## Switch to standby

To switch the TV to standby, press **Power** on the remote control. You can also press the small joystick key on the bottom of the TV.



In standby mode, the TV is still connected to the mains power but consumes very little energy.

To switch off the TV completely, disconnect the power plug.

When disconnecting the power plug, always pull the power plug, never the cord. Ensure that you have full access to the power plug, power cord and outlet socket at all times.

---

# Channels

---

## 5.1

### About Channels and Switch Channels

#### To watch TV channels

- Press **SOURCES**, and the TV tunes to the last viewed input. Press **SOURCES** again and select TV source to watch TV.
- Press **Home** > **Live TV** and press **OK**.
- Press **Channel +** or **Channel -** to switch channels.
- If you know the channel number, type in the number with the number keys. Press **OK** after you entered the number to switch channels.

#### To switch to a channel from a channel list

- While watching a TV channel, press **OK** to open the channel lists.
- The channel list can have several pages with channels. To view the next or previous page, follow the on-screen instruction.
- To close the channel lists without switching channels, press **Back**.

#### Radio channels

If digital broadcasting is available, digital radio stations are installed during installation. Switch to a radio channel just like you switch to a TV channel.

TV may not work properly with some operators of digital television, non-compliance with requirements of the standard in full.

---

## 5.2

### Channel Lists

---

#### About Channel Lists

After a channel installation, all channels appear on the channel list. Channels are shown with their name if this information is available.

With a channel list selected, press **Navigation keys** up or down to select a channel, then press **OK** to watch the selected channel.

#### Radio stations

If digital broadcasting is available, digital radio stations are installed during installation. Switch to a radio channel just like you switch to a TV channel.

TV may not work properly with some operators of digital television, non-compliance with requirements of the standard in full.

---

### Open a Channel List

Next to the list with all channels, you can select a filtered list or you can select one of the favourite lists you created.

#### To open the current channel list...

- 1 - While watching TV, press **OK** to open the current channel list.
- 2 - Press **Back** to close the channel list.

---

### Search for a Channel

You can search for a channel to find it in a long list of channels.

#### To search for a channel...

- 1 - Press **OK** to open the current channel list.
- 2 - Press **Yellow key** for **Select more**.
- 3 - Select **Find** and press **OK** to open a text field. You can use the remote control keyboard (if available) or the on-screen keyboard to enter text.
- 4 - Enter a number, a name or part of a name and press **OK**. The TV will search for matching channel names in the list you selected.

Search results are listed as a channel list - see the list name at the top. The search results disappear once you select another channel list or close the list with search results.

---

### Channel List sorting

You can do channel list sorting with all channels. You can set the channel list to show only TV channels or only Radio stations. For Antenna channels you can set the list to show the Free-to-Air or the Scrambled channels.

#### To set a filter on a list with all channels...

- 1 - Press **OK** to open the current channel list.
- 2 - Press **Yellow key** for **Select more**.
- 3 - Select **Sort** and press **OK**.
- 4 - Select the filter you want and press **OK** to activate. The name of the filter appears as part of the channel list name on top of the channel list.
- 5 - Press **Back** to close the channel list.

---

## 5.3

### Watching channels

---

## Tune to a Channel

To start watching TV channels...

1 - Press **SOURCES**. The TV tunes to the last viewed input.

2 - Press **SOURCES** again and select TV source to watch TV.

Alternatively, you can select **Live TV** from the Home screen.

### Switch Channels

To switch channels, press **Channel +** or **Channel -**. If you know the channel number, type in the number with the number keys. Press **OK** after you entered the number to switch immediately.

If the information is available from the Internet, the TV shows the current programme name and details followed by the next programme name and details.

You can also tune to channels from a **Channel List** by pressing **OK**.

---

## Parental Controls

### Lock and Unlock a Channel

To prevent children from watching a channel, you can lock a channel. To watch a locked channel, you must enter the 4 digit PIN code first. You cannot lock programmes from connected devices.

To lock or unlock a channel...

1 - Press **MENU > Settings > Channel > Parental Controls** and press **OK**.

2 - Enter your PIN code if necessary.

3 - Select **Channel Blocked** and press **OK**.

4 - Press **Navigation keys up or down** to select the channel you want to lock or unlock, and press **OK**.

5 - A locked channel is marked with a lock icon.

6 - Press **Back**, repeatedly if necessary, to close the menu.

---

### Programme Restrictions

To prevent children from watching a programme that may not be suitable for them, you can set a rating.

Digital channels can have their programmes rated. When the rating of a programme is equal to or higher than the rating you have set, the programme will be locked. To watch a locked programme, you must enter the PIN code first.

To set a rating...

1 - Press **MENU > Settings > Channel > Parental Controls** and press **OK**.

2 - Enter your PIN code if necessary.

3 - Select **Programme Restrictions** and press **OK**.

4 - Select **On** to set the rating.

5 - Select **Ratings** and press **OK**.

6 - Set the restrictions for your children.

7 - Press **Back**, repeatedly if necessary, to close the menu.

To switch off the parental rating, select **None**.

However, in some countries you must set a rating.

For some broadcasters/operators, the TV only locks programmes with a higher rating. The parental rating is set for all channels.

---

### Inputs Blocked

To prevent from using connected devices, you can lock an input source. To connect a locked input source, you must enter the 4 digit PIN code first.

To lock or unlock an input source...

1 - Press **MENU > Settings > Channel > Parental Controls** and press **OK**.

2 - Enter your PIN code if necessary.

3 - Select **Input Blocked** and press **OK**.

4 - Press **Navigation keys up or down** to select the source you want to lock or unlock, and press **OK**.

5 - A locked source is marked with a lock icon.

6 - Press **Back**, repeatedly if necessary, to close the menu.

---

### Change PIN

Set new or reset PIN code. The PIN code is used to lock or unlock channels or programmes.

1 - Press **MENU > Settings > Channel > Parental Controls** and press **OK**.

2 - Enter your PIN code if necessary.

3 - Select **Change PIN** and press **OK**.

4 - Enter the current PIN code and new PIN code.

5 - Press **Back**, repeatedly if necessary, to close the menu.

---

## 5.4

## Favourite Channels

---

### About Favourite Channels

In a favourite channel list, you can collect the channels you like.

You can create 4 different lists of favourite channels for easy channel zapping.

With a Favourites List selected, press the **Navigation keys up or down** to select a channel, then press **OK** to watch the selected channel.

---

## Edit a Favourites List

To create a favourite channels list...

- 1 - While watching TV, press **OK** to open the current channel list.
- 2 - Press **Blue** key for **Favourites List**.
- 3 - Press **Yellow** key for **Select list**, select the list of **Favourites1** to **Favourites4** you want to add.
- 4 - While watching TV, press **MENU > Channels**.
- 5 - Select **Add to my favourites** and press **OK**.

To remove a channel from the favourites list...

- 1 - Select the list of **Favourites1** to **Favourites4** you want to edit.
- 2 - Press **Navigation** keys up or down to select a channel, press **Blue** key for **Delete** to remove the channel from the favourite channel list.

---

5.5

## Text / Teletext

---

### Text Pages

To open Text/Teletext press **TEXT**, while you are watching TV channels.

To close Text, press **TEXT** again.

#### Select a Text page

To select a page . . .

- 1 - Enter the page number with the number keys.
- 2 - Use the **Navigation** keys to navigate.
- 3 - Press a colour key to select a colour-coded subject at the bottom of the screen.

#### Text sub-pages

A Text page number can hold several subpages. The subpage numbers are shown on a bar next to the main page number.

To select a subpage, press **Navigation** keys left or right.

---

## Text Setup

### Text language

Some digital TV broadcasters have several Text languages available.

To set your primary and secondary Text language . . .

- 1 - Select **MENU > TV options > Advanced Options > Teletext** and press **Navigation** keys right to enter the menu.
- 2 - Select **Digital Teletext Language** or **Decoding Page Language** and press **OK**.

3 - Select your preferred Text languages.

4 - Press **Back**, repeatedly if necessary, to close the menu.

---

5.6

## Interactive TV

---

### About iTV

With interactive TV, some digital broadcasters combine their normal TV programme with information or entertainment pages. On some pages, you can respond to a programme or vote, do online shopping or pay for a video-on-demand programme.

#### HbbTV . . .

Interactive TV is sometimes referred to as Digital Text or Red button. But each system is distinct.

Visit the broadcaster's Internet website for more information.

---

### What You Need

Interactive TV is only available on digital TV channels. To enjoy the full benefits of Interactive TV, you need a high-speed (broadband) Internet connection to the TV.

#### HbbTV

If a TV channel offers HbbTV pages, you must first switch on HbbTV in the TV settings to view the pages.

To switch on the HBBTV support

**MENU > TV options > Advanced options > HbbTV settings**

---

### Use iTV

#### Open iTV pages

Most channels that offer HbbTV or iTV invite you to press the colour key or **OK** key to open their interactive programme.

#### Navigate iTV pages

You can use the arrow and colour keys, the number keys and the **Back** key to navigate the iTV pages. You can use the **Play**, **Pause** and **Stop** keys to watch videos within iTV pages.

#### Close iTV pages

Most iTV pages inform you which key to use to close.

To force an iTV page to close, switch to the next TV channel and press **Back**.

---

# Channel Installation

---

## 6.1

### Antenna Installation

- 1 - Press **MENU** > **TV options** > **Settings** > **Channel** and press **OK**.
- 2 - Select **Channels** > **Channel Scan** and press **OK**.

Alternatively, you can perform the channel scan by...

**MENU** > **Navigation Keys up** > **Channels** > **New Channels Available**

---

## 6.2

### Update Channels

#### Automatic Channel Update

If you receive digital channels, you can set the TV to automatically update these channels.

Once a day, the TV updates the channels and stores new channels. The TV must be in standby to automatically update channels. You can switch off automatic update.

To switch off the automatic update...

- 1 - Press **MENU** > **TV options** > **Settings** > **Channel**.
- 2 - Enter your PIN code if necessary.
- 3 - Select **Auto Channel Update** and press **OK**.
- 4 - Press **Back**, repeatedly if necessary, to close the menu.

In certain countries, the Automatic channel update is done while watching TV or on any moment when the TV is in standby.

---

#### Manual Channel Update

You can always start a channel update yourself.

To start a channel update manually...

- 1 - Press **MENU** > **TV options** > **Settings** > **Channel** > **Channels** > **Channel Scan** and press **OK**.
- 2 - Enter your PIN code if necessary.
- 3 - Select **Search for Channels** and press **OK** to update channels. This can take a few minutes.
- 4 - Press **Back**, repeatedly if necessary, to close the menu.

### Reception Quality

You can check the quality and signal strength of a digital channel. If you have your own antenna, you can reposition the antenna to try and improve the reception.

To check the reception quality of a digital channel...

- 1 - Press **MENU** > **TV options** > **Settings** > **Channel** > **Channels** > **Single RF Scan** and press **OK**.
  - 2 - Select **RF Channel**.
  - 3 - Press **Navigation keys left or right** to select a channel and press **OK**. The signal level and signal quality is shown for this channel.
  - 4 - Press **Back**, repeatedly if necessary, to close the menu.
- 

## 6.4

### Analog Manual Scan

Analog TV channels can be manually installed.

To install analog channels manually...

- 1 - Press **MENU** > **TV options** > **Settings** > **Channel** > **Channels** and press **OK**.
  - 2 - Select **Analog Manual Scan** and press **OK**.
- 

## 6.5

### Channel Scan or Store Type

You can set the channel type for scanned or stored.

To set the channel scan type...

- 1 - Press **MENU** > **TV options** > **Settings** > **Channel** > **Channels** and press **OK**.
- 2 - Select **Channel Scan Type** and press **OK**.
- 3 - Select the scan type you want and press **OK**.
- 4 - Press **Back**, repeatedly if necessary, to close the menu.

To set the channel store type...

- 1 - Press **MENU** > **TV options** > **Settings** > **Channel** > **Channels** and press **OK**.
- 2 - Select **Channel Store Type** and press **OK**.
- 3 - Select the store type you want and press **OK**.
- 4 - Press **Back**, repeatedly if necessary, to close the menu.

---

6.6

## Channel Skip

You can skip the channels you do not want to watch.

To set the skipped channels ...

- 1 - Press **MENU** > **TV options** > **Settings** > **Channel** > **Channels** and press **OK**.
- 2 - Select **Channel Skip** and press **OK**.
- 3 - Select the channels you want to skip and press **OK**. The check mark is shown.
- 4 - Press **Back**, repeatedly if necessary, to close the menu.

---

6.7

## Channel Move

You can change the channels order as you like.

To move channels ...

- 1 - Press **MENU** > **TV options** > **Settings** > **Channel** > **Channels** and press **OK**.
- 2 - Select **Channel Move** and press **OK**.
- 3 - Follow the on-screen description to select.
- 4 - Press **Back**, repeatedly if necessary, to close the menu.

---

6.8

## Channel Sort

You can sort the channels by genre.

To sort the channels ...

- 1 - Press **MENU** > **TV options** > **Settings** > **Channel** > **Channels** and press **OK**.
- 2 - Select **Channel Sort** and press **OK**.
- 3 - Follow the on-screen description to select.
- 4 - Press **Back**, repeatedly if necessary, to close the menu.

---

6.9

## Channel Edit

You can edit the channels from the channel list.

To edit the channels ...

- 1 - Press **MENU** > **TV options** > **Settings** > **Channel** > **Channels** and press **OK**.
- 2 - Select **Channel Edit** and press **OK**.
- 3 - Use the **Navigation** keys to select the channel and press **Yellow** key for **Select**.
- 4 - Follow the on-screen instruction.

5 - Press **Back**, repeatedly if necessary, to close the menu.

---

6.10

## Analog Channel Fine Tune

Analog TV channels can be manually fine tuned.

To fine tune a channel...

- 1 - Press **MENU** > **TV options** > **Settings** > **Channel** > **Channels** and press **OK**.
- 2 - Select **Analog Channel Fine-tune** and press **OK**.
- 3 - You can fine tune the channel.
- 4 - Press **Back**, repeatedly if necessary, to close the menu.

---

6.11

## Clear Channel List

You can clear all channels and leave all other TV settings untouched.

To clear channel list...

- 1 - Press **MENU** > **TV options** > **Settings** > **Channel** > **Channels** and press **OK**.
- 2 - Select **Clear Channel List** and press **OK**.
- 3 - Select **OK** to clear the current channel list.
- 4 - Press **Back**, repeatedly if necessary, to close the menu.

# Connect Devices

## About Connections

### Connectivity Guide

Always connect a device to the TV with the highest quality connection available. Also, use good quality cables to ensure a good transfer of picture and sound.

When you connect a device, the TV recognizes its type and gives each device a correct type name. You can change the type name if you wish. If a correct type name for a device is set, the TV automatically switches to the ideal TV settings when you switch to this device in the Sources menu.

### Antenna port

If you have a Set-top box (a digital receiver) or Recorder, connect the antenna cables to run the antenna signal through the Set-top box and/or Recorder first before it enters the TV. In this way, the antenna and the Set-top box can send possible additional channels to the Recorder to record.

### HDMI ports

#### HDMI Quality

An HDMI connection has the best picture and sound quality. One HDMI cable combines video and audio signals. Use an HDMI cable for TV signal.

For best signal quality transfer, use a High speed HDMI cable and do not use an HDMI cable longer than 5 m.

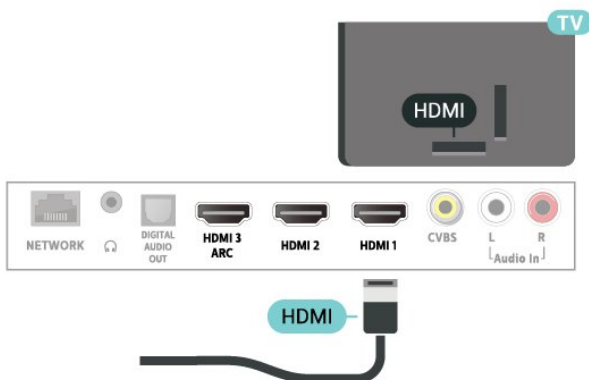

#### Copy protection

HDCP (High-bandwidth Digital Content Protection) is

a copy protection signal that prevents copying content from a DVD disc or Blu-ray Disc. Also referred to as DRM (Digital Rights Management).

#### HDMI ARC

Only HDMI 3 connection on the TV has HDMI ARC (Audio Return Channel).

If the device, typically a Home Theatre System (HTS), also has the HDMI ARC connection, connect it to HDMI 3 on this TV. With the HDMI ARC connection, you do not need to connect the extra audio cable that sends the sound of the TV picture to the HTS. The HDMI ARC connection combines both signals.

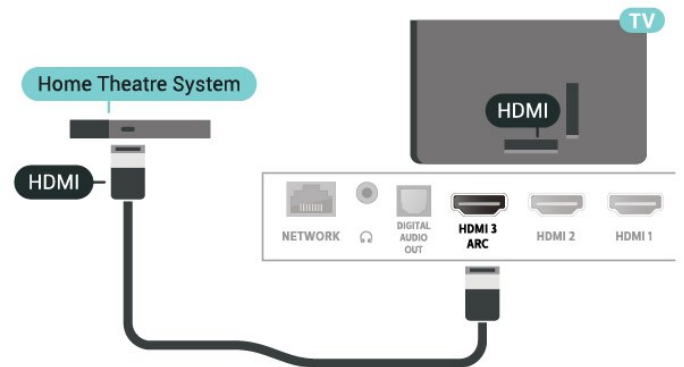

#### HDMI CEC

An HDMI connection has the best picture and sound quality. One HDMI cable combines video and audio signals. Use an HDMI cable for High Definition (HD) TV signals. For best signal quality transfer, use a High speed HDMI cable and do not use an HDMI cable longer than 5 m.

Connect HDMI CEC-compatible devices to your TV, you can operate them with the TV remote control.



HDMI CEC (Consumer Electronic Control) must be switched on on the TV and the connected device.

#### Switch on CEC

Allow the TV to control HDMI device.

MENU > TV options > Settings > Device Preferences > Inputs > HDMI control.



## Device auto power off

Turn off the HDMI devices with the TV.

MENU > TV options > Settings > Device Preferences > Inputs > Device auto power off.

## TV auto power on

Power on the TV with HDMI devices.

MENU > TV options > Settings > Device Preferences > Inputs > TV auto power on.

## CEC Device List

Check the connected HDMI CEC device list.

MENU > TV options > Settings > Device Preferences > Inputs > CEC device list.

### Note:

- HDMI CEC might not work with devices from other brands.
- The HDMI CEC functionality has different names on different brands. Some examples are: Anynet, Aquos Link, Bravia Theatre Sync, Kuro Link, Simplink and Viera Link. Not all brands are fully compatible with EasyLink. Example HDMI CEC branding names are property of their respective owners.

7.2

## Home Theatre System - HTS

### Connect with HDMI ARC

Use an HDMI cable to connect a Home Theatre System (HTS) to the TV. You can connect a Philips Soundbar or an HTS with a built-in disc player.

#### HDMI ARC

If your Home Theatre System has an HDMI ARC connection, you can use HDMI ARC connection on the TV to connect. With HDMI ARC, you do not need to connect the extra audio cable. The HDMI ARC connection combines both signals. Since HDMI 3 on the TV can offer the Audio Return Channel (ARC) signal, the TV can only send the ARC signal to this HDMI connection.

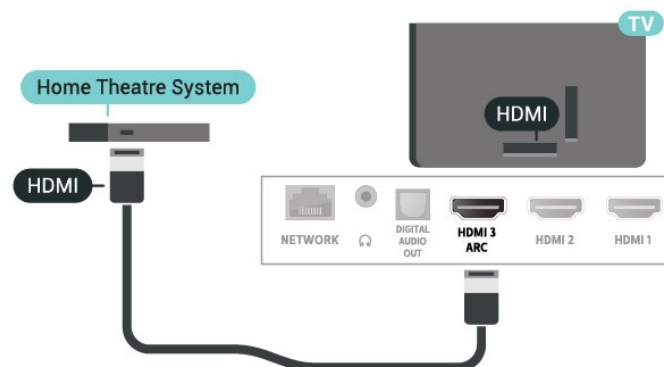

### Audio to video synchronisation (sync)

If the sound does not match the video on screen, you can set a delay on most Home Theatre Systems with a disc player to match the sound with the video.

## Connect with HDMI

Use an HDMI cable to connect a Home Theatre System (HTS) to the TV. You can connect a Philips Soundbar or an HTS with a built-in disc player.

If the Home Theatre System has no HDMI ARC connection, add an optical audio cable to send the sound of the TV picture to the Home Theatre System.

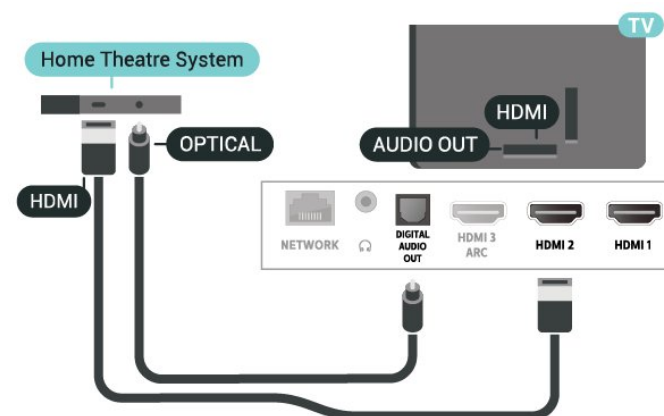

### Audio to video synchronisation (sync)

If the sound does not match the video on screen, you can set a delay on most Home Theatre Systems with a disc player to match the sound with the video.

7.3

## Video Device

### HDMI

Use a **High speed HDMI** cable to connect with best picture and sound quality.

For best signal quality transfer, use a High speed HDMI cable and do not use an HDMI cable longer than 5 m.

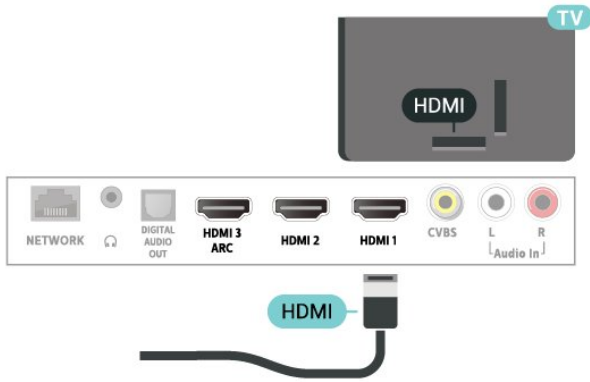

## Copy protection

HDMI ports support HDCP (High-bandwidth Digital Content Protection). HDCP is a copy protection signal that prevents copying content from a DVD disc or Blu-ray Disc. Also referred to as DRM (Digital Rights Management).

## Composite

AV IN - Composite Video is a standard quality connection.

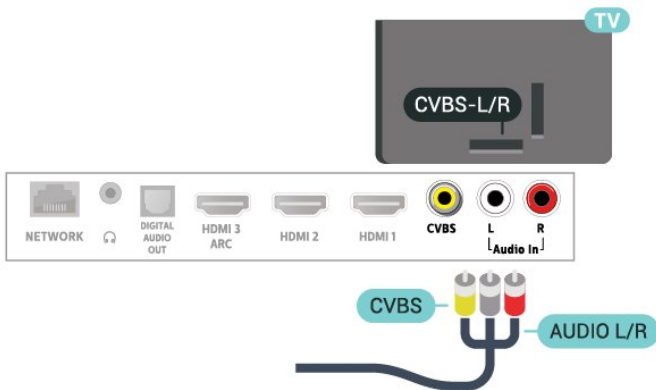

7.4

## Audio Device

### Digital Audio Out - Optical

Audio Out - Optical is a high quality sound connection.

This optical connection can carry 5.1 audio channels. If your device, typically a Home Theatre System (HTS), has no HDMI ARC connection, you can use this connection with the Audio In - Optical connection on the HTS. The Audio Out - Optical connection sends the sound from the TV to the HTS.

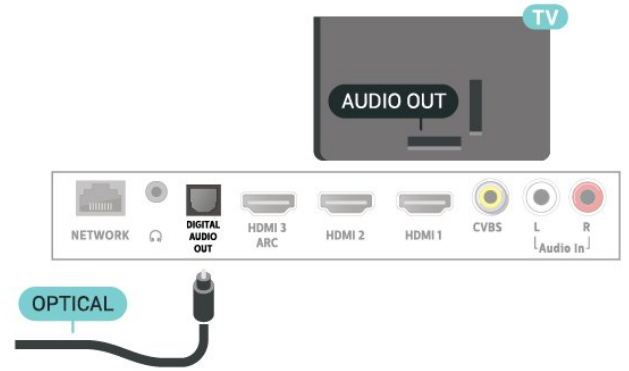

## Headphones

You can connect a set of headphones to the headphone connector on the back of the TV. The connection is a mini-jack 3.5mm. You can adjust the volume of the headphones separately.

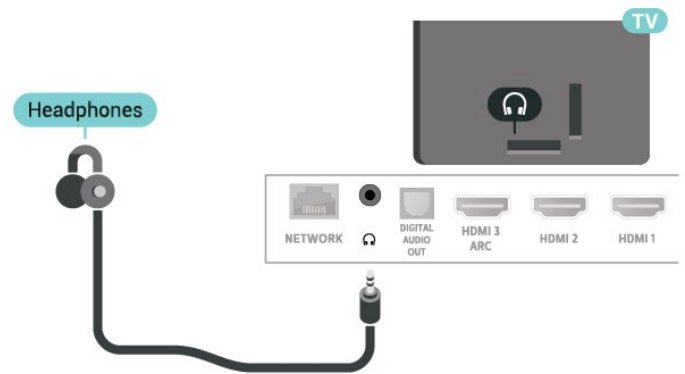

7.5

## USB Hard Drive

### What You Need

If you connect a USB Hard Drive, you can pause or record digital TV broadcasts. The TV broadcast must be a digital broadcast (DVB broadcasts or similar).

#### Minimum Disk Space

- To Pause

To pause a broadcast, you need a USB 2.0 compatible Hard Drive with a minimum of 4GB disk space.

- To Record

To pause and record a broadcast, you need a minimum of 250GB disk space.

---

## Installation

Before you can pause or record a broadcast, you must connect and format a USB Hard Drive. Formatting removes all files from the USB Hard Drive.

- 1 - Connect the USB Hard Drive to one of the USB connections on the TV. Do not connect another USB device to the other USB ports when formatting.
- 2 - Switch on the USB Hard Drive and the TV.
- 3 - When the TV is tuned to a digital TV channel, press **Pause**. Trying to pause will start the formatting.

Follow the instructions on screen.

When the USB Hard Drive is formatted, leave it connected permanently.

Note: The maximum supported hard drive partition size is 2 TB.

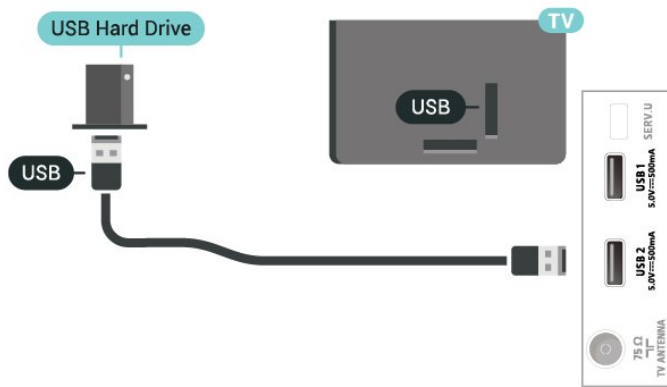

### Warning

The USB Hard Drive is formatted exclusively for this TV, you cannot use the stored recordings on another TV or PC. Do not copy or change recording files on the USB Hard Drive with any PC application. This will corrupt your recordings. When you format another USB Hard Drive, the content on the former will be lost. A USB Hard Drive installed on your TV will need reformatting for use with a computer.

---

## Formatting

Before you can pause or record a broadcast, or store apps, you must connect and format a USB Hard Drive. Formatting removes all files from the USB Hard Drive.

### Warning

The USB Hard Drive is formatted exclusively for this TV, you cannot use the stored recordings on another TV or PC. Do not copy or change recording files on the USB Hard Drive with any PC application. This will corrupt your recordings. When you format another USB Hard Drive, the content on the former will be lost. A USB Hard Drive installed on your TV will need

reformatting for use with a computer.

Note: The maximum supported hard drive partition size is 2 TB.

### To format a USB Hard Drive...

#### If you use FAT32 USB device:

- 1 - Connect the FAT32 USB Hard Drive to one of the USB connections on the TV. Do not connect another USB device to the other USB ports when formatting.
- 2 - Switch on the USB Hard Drive and the TV.
- 3 - Press **Home**. Select the **Settings** icon from the top-right corner and press **OK**.
- 4 - Select **Device Preferences > Storage > USB drive > Erase & format as removable storage > Format** and press **OK**. Don't remove the drive while formatting.
- 5 - The **USB drive is formatted** notice appears.

#### If you use non-FAT32 USB device:

- 1 - Connect the exFAT USB Hard Drive to one of the USB connections on the TV. Do not connect another USB device to the other USB ports when formatting.
- 2 - Switch on the USB Hard Drive and the TV.
- 3 - Press **Home**. The **Issue with USB drive** notice appears.
- 4 - Select the **Notifications** icon from the top-right corner and press **OK**.
- 5 - Select **Issue with USB drive > Set up as device storage > Format**, and press **OK**. Don't remove the drive while formatting.
- 6 - When the formatting is completed, select **Move now** and press **OK**. Don't remove the drive while the data moving.
- 7 - When the data moving is completed, the **Home** page opens.
- 8 - Select the **Settings** icon from the top-right corner and press **OK**.
- 9 - Select **Device Preferences > Storage > USB drive > Erase & format as removable storage > Format** and press **OK**. Don't remove the drive while formatting.
- 10 - The **USB drive is formatted** notice appears.

#### Note:

- Removable storage (FAT32) is for PVR, Timeshift, viewing videos, pictures, and playing music.
- Device storage is for Apps installation.

---

## 7.6

## USB Flash Drive

You can view photos or play your music and videos from a connected USB flash drive.

Insert a USB flash drive in one of the **USB** connections on the TV while the TV is switched on.

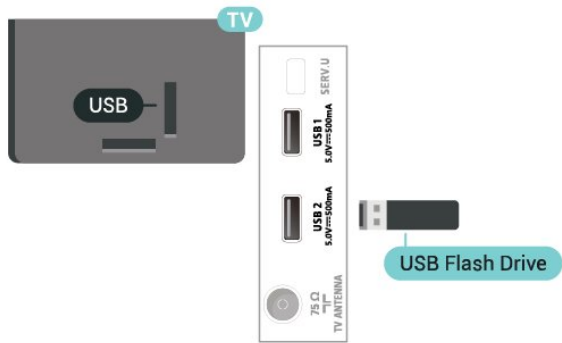

To view the files from the USB flash drive, you need to add the MMP (MultiMediaPlayer) app to the Home page first. Press **Home**, clicking the Apps icon at the left end of the Apps row. You can add MMP apps from the Apps page.

To stop watching the USB flash drive content, press **EXIT** or select another activity.

To disconnect the USB flash drive, exit the MMP before you pull out the flash drive.

### Ultra HD on USB

You can view photos in Ultra HD resolution from a connected USB device or flash drive. The TV will downscale the resolution if the resolution of the photo is higher.

---

# Bluetooth®

---

## 8.1

## What You Need

You can connect a wireless device with Bluetooth® to this TV – a wireless speaker or headphones.

To enable the TV audio on a wireless speaker, you must pair the wireless speaker with the TV. The TV can only play the sound on one speaker at a time.

### Attention

Before you purchase a wireless Bluetooth® speaker system, please find out more about the newest models and look for a device with a low latency rating. Ask your dealer for advice.

### Disclaimer:

Due to the transmission limitations of Bluetooth® wireless technology, a slight sound delay might occur when you hear audio from your Bluetooth® headphone or Bluetooth® speakers.

When this occur, you might see the character moving his or her mouth but there is a slight delay in spoken dialog accompany it – commonly known as lip Sync error.

## 8.2

---

## Pairing a Device

Position the wireless speaker within a distance of 5 meters from the TV. Read the user manual of the device for specific information on pairing and on wireless range. Make sure the Bluetooth® setting on TV is switched on.

Once a wireless speaker is paired, you can select it to play the TV sound. When a device is paired, you do not need to pair it again unless you remove the device.

To pair a Bluetooth® device with the TV...

- 1 - Switch on the Bluetooth® device and place it within range of the TV.
- 2 - Press **MENU > TV options > Settings > Remote & Accessories** and press **OK**.
- 3 - Select **Pair** and press **OK**. Follow the instructions on screen. You will pair the device with the TV and the TV will store the connection. You might need to unpair a paired device first if the maximum number of paired devices was reached.
- 4 - Press **Back**, repeatedly if necessary, to close the menu.

### Note:

Only one Bluetooth® sound output can be paired at a time, if you would like to pair another Bluetooth® speaker or headphones, please un-pair the current one first.

## 8.3

---

## Select a Device

To select a wireless device...

- 1 - Press **MENU > TV options > Settings > Remote & Accessories** and press **OK**.
- 2 - In the list, select the wireless device and press **OK**.
- 3 - Press **Back**, repeatedly if necessary, to close the menu.

## 8.4

---

## Rename a Device

To rename a wireless device...

- 1 - Press **MENU > TV options > Settings > Remote & Accessories** and press **OK**.
- 2 - In the list, select the wireless device and press **OK**.
- 3 - Select **Change name** and press **OK**.
- 4 - Enter a new name for the device.
- 5 - Press **Back**, repeatedly if necessary, to close the menu.

## 8.5

---

## Remove a Device

You can connect or disconnect a wireless Bluetooth® device. You can also remove a wireless Bluetooth® device. If you remove a Bluetooth® device, the device will be unpaired.

To remove or disconnect a wireless device...

- 1 - Press **MENU > TV options > Settings > Remote & Accessories** and press **OK**.
- 2 - In the list, select the wireless device and press **OK**.
- 3 - Select **Unpair** and press **OK**.
- 4 - Press **Back**, repeatedly if necessary, to close the menu.

# Connect your Android TV

## Network and Internet

### Home Network

To enjoy the full capabilities of your Philips Android TV, your TV must be connected to the Internet.

Connect the TV to a home network with a high-speed Internet connection. You can connect your TV wirelessly or wired to your network router.

### Connect to Network

#### Wireless Connection

##### What You Need

To connect the TV to the Internet wirelessly, you need a Wi-Fi router with a connection to the Internet.

Use a high-speed (broadband) connection to the Internet.



##### Turn Wi-Fi On or Off

MENU > TV options > Settings > Network & internet > Wi-Fi.

##### Make the Connection

MENU > TV options > Settings > Network & internet > Wi-Fi.

- 1 - In the list of found networks, select on your wireless network. If your network is not in the list because the network name is hidden (you switched off the SSID broadcast of the router), select **Add new network** to enter the network name yourself.
- 2 - Follow the on-screen instruction.
- 3 - A message will be shown when the connection is successful.

### Problems

#### Wireless network not found or distorted

- Microwave ovens, DECT phones or other Wi-Fi 802.11b/g/n devices in your proximity might disturb the wireless network.
- Make sure that the firewalls in your network allow access to the TV's wireless connection.
- If the wireless network does not work properly in your home, try the wired network installation.

#### Internet does not work

- If the connection to the router is OK, check the router connection to the Internet.

#### The PC and Internet connection are slow

- Look in your wireless router's user manual for information on indoor range, transfer rate and other factors of signal quality.
- Use a high-speed (broadband) Internet connection for your router.

#### DHCP

- If the connection fails, you can check the DHCP (Dynamic Host Configuration Protocol) setting of the router. DHCP should be switched on.

#### Wired Connection

##### What You Need

To connect the TV to the Internet, you need a network router with a connection to the Internet. Use a high-speed (broadband) connection to the Internet.

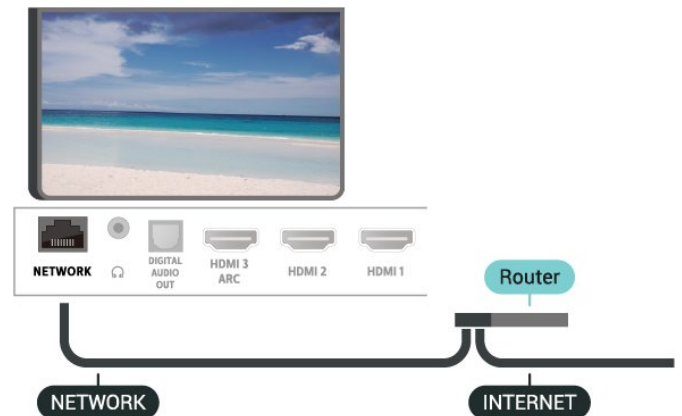

##### Make the Connection

- 1 - Connect the router to the TV with a network cable (Ethernet cable\*\*).
- 2 - Make sure that the router is switched on.
- 3 - The TV constantly searches for the network connection.
- 4 - A message will be shown when the connection is successful.

If the connection fails, you can check the DHCP setting of the router. DHCP should be switched on.

\*\*To fulfill EMC regulations, use a shielded FTP Cat. 5E Ethernet cable.

---

## Network Settings

### Proxy settings

MENU > TV options > Settings > Network & internet > Proxy settings.

Enter a valid proxy hostname manually by selecting Manual.

### Network Configuration - IP settings

MENU > TV options > Settings > Network & internet > IP settings.

If the connection fails, you can check the DHCP setting of the router.

Alternatively, if you are an advanced user and want to install your network with static IP addressing, set the TV to Static IP.

---

9.2

## Google Account

### Sign In

To enjoy the full capabilities of your Philips Android TV, you can sign in to Google with your Google Account.

By signing in you'll be able to play your favourite games across phone, tablet and TV. You'll also get customised video and music recommendations on your TV home screen as well as access to YouTube, Google Play and other apps.

### Sign In

Use your existing **Google Account** to sign in to Google on your TV. A Google Account consists of an email address and a password. If you don't have a Google Account yet, use your computer or tablet to create one (accounts.google.com). To play games with Google Play, you need a Google+ profile. If you did not sign in during the first TV installation, you can always sign in later.

To sign in after the TV installation...

- 1 - Select **Settings**.
- 2 - Select **Account & Sign-In** and press **OK**.
- 3 - Select **Sign In** and press **OK**.
- 4 - Select **Use your remote** and press **OK**.
- 5 - With the on-screen keyboard, enter your email address and press **OK**.
- 6 - Enter your password and press **OK** to sign in.

7 - Press **Navigation keys** left repeatedly if necessary, to close the menu.

---

## Android Settings

You can set or view several Android specific settings or information. You can find the list of apps installed on your TV and the storage space they need. You can set the language you like to use with Voice Search. You can configure the onscreen keyboard or allow apps to use your location. Explore the different Android settings. You can go to [www.support.google.com/androidtv](http://www.support.google.com/androidtv) for more information on these settings.

To open these settings...

- 1 - Select **Settings** and press **OK**.
- 2 - Explore the different Android settings.
- 3 - Press **Back** if necessary, to close the menu.

---

9.3

## Home Screen

### About the Home Screen

To enjoy the benefits of your Android TV, connect the TV to the Internet.

Like on your Android smartphone or tablet, the Home screen is the centre of your TV. From the Home screen you can decide what to watch by browsing entertainment options from app and live TV. Your Home has channels to let you discover great contents from your favourite apps. You can also add additional channels or find new apps to get more contents.

The Home screen is organised in channels...

### Apps

Your favourite Apps are placed on the first row. You can find more apps in the Apps page which can be opened by clicking the **Apps** icon at the left end of the **Apps** row. You can also add more apps as favourite from the Apps page.

### Live TV

Live TV channel shows the currently running programmes from the installed channels.

### Play Next channel

You can always know what to watch next from **Play Next** channel on the Home screen. Start watching from where you left off and get notifications about new episodes in the **Play Next** channel. Press and hold **Select** on a movie or TV show to add it directly to the **Play Next** channel.

### Google Play Movies & TV channel

Rent movies or TV shows on this channel from Google Play Movies & TV.

#### YouTube channel

This channel contains your Recommended, Subscriptions or Trending YouTube videos.

#### Customize channels

Click the **Customize channels** button to add and remove channels from your Home screen.

See also [www.support.google.com/androidtv](http://www.support.google.com/androidtv)

---

## Open the Home Screen

To open the Home screen and open an item...

- 1 - Press **Home**.
- 2 - Select an item and press **OK** to open or start it.
- 3 - Press **Back** continuously or press **Home** can go back to Home screen.

When opening the Home screen, the background application/content playback will stop. You have to select the application or content from the Home screen to resume.



---

# Apps

---

## 10.1

## About Apps

You can find your favourite Apps on **Apps** row in the Home menu.

Like apps on your smartphone or tablet, the apps on your TV offer specific functions for an enriched TV experience. Apps like YouTube, games, video stores or weather forecasts (a.o.).

Apps can come from the **Google Play™ Store** . To get you started, some practical apps are pre-installed on your TV.

To install apps from the **Google Play™ Store** , the TV must be connected to the Internet. You must sign in with a Google Account to use the Google Play apps and **Google Play™ Store** .

## 10.2

---

## Google Play

---

### Movies and TV

With **Google Play Movies & TV** , you can rent or buy movies and TV shows to watch on TV.

#### What You Need

- your TV must be connected with the Internet
- you must sign in with your Google Account on TV
- add a credit card to your Google Account to purchase movies and TV shows

To rent or buy a movie or TV show...

- 1 - Press **Home**.
- 2 - Select **Google Play Movies & TV**.
- 3 - Select a movie or TV show and press **OK**.
- 4 - Select the purchase you want and press **OK**. You will be taken through the purchase procedure.

To watch a rented or bought movie or TV show...

- 1 - Press **Home**.
- 2 - Select **Google Play Movies & TV**.
- 3 - Select the movie or TV show from your library in the app, select the title and press **OK**.
- 4 - You can use the **Stop**, **Pause**, **Rewind** or **Fast forward** keys on the remote control.
- 5 - To stop the **Movies & TV** app, press **Back** repeatedly or press **EXIT**.

If the App is not on you Home screen, you can add via the Apps page or by the **Add app to favourites** item on the **Apps** row. Some Google Play products and features aren't available in all countries.

Find more information on [www.support.google.com/androidtv](http://www.support.google.com/androidtv)

---

## Music

With **YouTube Music**, you can play your favourite music on TV.

You can buy new music on your computer or mobile device. Or, on your TV, you can sign up for All Access, the Google Play Music subscription. Alternatively, you can play the music you already own, stored on your computer.

#### What You Need

- your TV must be connected with the Internet
- you must sign in with your Google Account on TV
- add a credit card to your Google Account to take a music subscription

To start **YouTube Music**...

- 1 - Press **Home**.
- 2 - Select **YouTube Music**.
- 3 - Select the music you want and press **OK**.
- 4 - To stop the Music app, press **Back** repeatedly or press **EXIT**.

If the App is not on you Home screen, you can add via the Apps page or by the **Add app to favourites** item on the **Apps** row. Some Google Play products and features aren't available in all countries.

Find more information on [support.google.com/androidtv](http://support.google.com/androidtv) or [support.google.com/youtubemusic](http://support.google.com/youtubemusic)

---

## Games

With **Google Play Games**, you can play games on TV. Online or offline.

You can see what your friends are playing currently or you can join the game and compete. You can track your achievements or start wherever you left off.

#### What You Need

- your TV must be connected with the Internet
- you must sign in with your Google Account on TV
- add a credit card to your Google Account to purchase new games

Start the **Google Play Games** app to select and install new game apps on your TV. Some games are free of charge. A message appears if a particular game needs a gamepad to play the game.

To start or stop a **Google Play Game**...

- 1 - Press **Home**.
- 2 - Select **Google Play Games**.
- 3 - Select a game to play or select a new game to install and press **OK**.

4 - When done, press **Back** repeatedly or press **EXIT** or stop the app with its dedicated exit/stop button.

If the App is not on your Home screen, you can add via the Apps page or by the **Add app to favourites** item on the **Apps** row. Some Google Play products and features aren't available in all countries.

Find more information on [www.support.google.com/androidtv](http://www.support.google.com/androidtv)

---

## Google Play Store

From the Google Play Store you can download and install new apps. Some apps are free of charge.

### What You Need

- your TV must be connected with the Internet
- you must sign in with your Google Account on TV
- add a credit card to your Google Account to purchase apps

### To install a new app...

- 1 - Press **Home**.
- 2 - Select **Google Play Store** and press **OK**.
- 3 - Select the app you want to install and press **OK**.
- 4 - To close the **Google Play Store**, press **Back** repeatedly or press **EXIT**.

### Parental controls

In the Google Play Store, you can hide apps according to users/buyers maturity. You need to enter a PIN code to select or change the level of maturity.

### To set the parental control...

- 1 - Press **Home**.
- 2 - Select **Google Play Store** and press **OK**.
- 3 - Select **Settings > Parental controls**.
- 4 - Select the level of maturity you want.
- 5 - On request, enter the PIN code.
- 6 - To close the **Google Play Store**, press **Back** repeatedly or press **EXIT**.

If the App is not on your Home screen, you can add via the Apps page or by the **Add app to favourites** item on the **Apps** row. Some Google Play products and features aren't available in all countries.

Find more information on [www.support.google.com/androidtv](http://www.support.google.com/androidtv)

---

## Payments

To make a payment on Google Play on TV, you must add a form of payment - a credit card (outside the United States) - to your Google Account. When you purchase a movie or TV show, you will be charged on this credit card.

### To add a credit card ...

- 1 - On your computer, go to [accounts.google.com](http://accounts.google.com) and sign in with the Google Account you will use with Google Play on TV.
- 2 - Go to [wallet.google.com](http://wallet.google.com) to add a card to your Google Account.
- 3 - Enter your credit card data and accept the terms and conditions.

---

## 10.3

## Start or Stop an App

You can start an app from the Home screen.

### To start an app...

- 1 - Press **Home**.
- 2 - Move to **Apps** row, select the app you want and press **OK**.
- 3 - To stop an app, press **Back** or press **EXIT** or stop the app with its dedicated exit/stop button.

When opening the Home screen, the background application/content playback will stop. You have to select the application or content from the Home screen to resume.

---

## 10.4

## Settings for Apps

**MENU > TV options > Settings > Apps.**

### Restricted Profile

You can restrict the use of certain apps by switching the TV to a restricted profile. The Home menu will only show the apps you allowed. You need a PIN code to switch out of the restricted profile.

**With the TV switched to a restricted profile you cannot...**

- Find or open apps which are marked as Not allowed
- Access the Google Play Store
- Purchase through Google Play Movies & TV, nor Google Play Games
- Use third-party apps that don't use the Google sign-in

**With the TV switched to a restricted profile you**

can...

- Watch content already rented or purchased from Google Play Movies & TV
- Play games already purchased and installed from Google Play Games
- Access the following settings: Wi-Fi network, Speech and Accessibility
- Add Bluetooth® accessories

The Google Account on TV will stay logged in. Using a restricted profile doesn't change the Google Account.

---

10.5

## Manage Apps

If you stop an app and return to the Home menu, the app is not really stopped. The app is still running in the background to be readily available when you start it again. To run fluently, most apps need to save some data in the cache memory of the TV. It might be good to stop an app completely or clear the cache data of a particular app to optimise the overall performance of apps and to keep memory usage low on your Android TV. Also, it is best to uninstall apps that you are not using anymore.

---

# Settings

---

## TV options

Press **MENU** to select one of below menus, then press **OK**.

### Picture mode

Select one of preset picture styles for ideal picture viewing.

### Display mode

Select one of preset picture format which fits the screen.

### Speakers

Set the TV to play the sound on TV or on the connected audio system.

### Power

Set the timers for saving energy.

### Manual OAD Download

Scan to search for an Over-the-air software update.  
Note: OAD is for Thailand, Malaysia, and Vietnam only.

### Advanced options

Adjust advanced settings.

### Settings

View settings menu.

---

## Picture Settings

---

### Picture Mode

Select a style

**MENU > TV options > Picture mode.**

For easy picture adjustment, you can select a preset picture style.

- User - The picture preferences you set during the first start up.
- Standard - Most energy conscious setting - Factory setting
- Vivid - Ideal for daylight viewing

- Sport - Ideal for sport
- Movie - Ideal for watching movies with original studio effect
- Game\* - Ideal for playing games
- Energy saving - Ideal for saving energy

\* Picture style - Game is not available for some video sources.

---

## Display Mode

If the picture is not filling the whole screen, if black bars are showing on the top or bottom or at both sides, you can adjust the picture to fill the screen completely.

To select one of the basic settings to fill the screen...

**MENU > TV options > Display mode.**

### Automatic

Automatically zooms in the picture to fit the screen with original aspect ratio. No content lost visible.

### Full

Automatically enlarges the picture to fill the screen. Picture distortion is minimal, subtitles remain visible. Not suitable for PC input. Some extreme picture content can still show black bars. Picture content aspect ratio may change.

### Super zoom

Remove the black bars on the sides of 4:3 broadcasts. Not recommended for HD or PC.

### Unscaled

Provide maximum detail for PC.

### 4:3

Display the classic 4:3 format.

### Movie expand 14:9

Scale 4:3 format to 14:9. Not recommended for HD or PC.

### Movie expand 16:9

Scale 4:3 format to 16:9. Not recommended for HD or PC.

### Wide screen

Stretches the picture to a 16:9 format.

---

## Other Picture Settings

MENU > TV options > Settings > Device preference > Picture and press OK.

### Backlight

Adjust the video backlight intensity.

### Brightness

Set the level of brightness of the picture signal.

**Note:** Setting of brightness much away from reference value (50) may result lower contrast.

### Contrast

Adjust the contrast value of the picture.

### Saturation

Adjust the colour saturation value of the picture.

### HUE

Adjust the hue value of the picture.

### Sharpness

Adjust the level of sharpness in fine detail of the picture.

### Gamma

Set a non-linear setting for picture luminance and contrast. This is a setting intended for expert users.

### Color Temperature

Set the picture to a preset color temperature or adjust the setting yourself.

### Advanced Video

set the advance settings.

- DNR
- MPEG NR
- Adaptive Luma Control
- Local Contrast Control
- DI Film Mode
- Blue Stretch
- Game Mode
- PC Mode
- HDMI RGB Range

### Color Tuner

Fine tune the color setting yourself.

### 11 Point White Balance Correction

Customise the whitepoint balance based on the selected colour temperature of the picture.

### Reset to default

Reset the current picture settings to default.

11.3

---

## Sound Settings

---

### Sound Style

MENU > TV options > Settings > Device preference > Sound > Sound style > and press OK.

For easy sound adjustment, you can select a preset setting with sound style.

- User - The sound preferences you set during the first start up.
- Standard - Most neutral sound setting
- Vivid - Ideal for travel channel or animal channel
- Sport - Ideal for sport
- Movie - Ideal for watching movies
- Music - Ideal for listening to music
- News - Ideal for speech
- Auto - Automatic sound based on the audio content.

---

### Other Sound Settings

MENU > TV options > Settings > Device preference > Sound and press OK.

#### Balance, Bass, Treble

Adjust the levels of these options according to your personal preference.

#### Sound Surround

Switch on or off the surround sound.

#### Equalizer Detail

Adjust the level of equaliser for your preference.

#### Speakers

Set the TV to play the sound on TV or on the connected audio system

You can select where you want to hear the TV sound and how you want to control it.

- If you select **External audio system**, you permanently switch off the TV speakers.
- If you select **TV speakers**, the TV speakers are always on. All the sound related settings (Bass, Treble, Surround mode etc) are applicable to this mode.

Alternatively, you can change the setting from MENU > TV options > Speakers.

#### Speaker Delay

Adjust the audio sync delay to synchronise the audio to the video.

#### Digital Output

Digital output settings are available for optical and

HDMI ARC sound signals.

Set the audio out signal of the TV to fit the sound capabilities of the connected Home Theatre System.

### SPDIF Delay

For some Home Theatre Systems you might need to adjust the audio sync delay to synchronise the audio to the video. Select 0 if a sound delay is set on your Home Theatre System.

### Auto Volume Control

Adjust large sound level differences between channels and inputs automatically.

### Advanced sound settings

set the advance settings.

- Dolby audio processing

### Reset to Default

Reset the current sound settings to default.

---

11.4

## Power Settings

MENU > TV options > Power.

### Set Sleep timer

Power > Sleep timer.

TV switches to standby mode automatically after a preset time.

### Set screen off to save energy consumption

Power > Picture off.

Select Picture off, the TV screen is switched off, to switch the TV screen back on, press any key on the remote control.

### Set TV switch off timer

Power > Switch off timer.

Select Switch off timer, the TV switches off automatically at a preset time to save energy.

### No signal auto power off

Power > No signal auto power off.

Press **Navigation keys** up or down to set the value. Select **Off** to deactivate the automatic switch off.

\* If you use the TV as a monitor or use a digital receiver to watch TV (a Set-Top Box - STB) and you do not use the remote control of the TV, you should

deactivate this automatic switch off, to set the value to **Off**.

---

11.5

## Advanced Options

### Audio Soundtracks

MENU > TV options > Advanced Options > Soundtracks.

Set the audio soundtracks based on the channel audio.

Note: This is for DTV only.

---

### HBBTV Settings

Note: This is for Singapore, Australia, and New Zealand only.

MENU > TV options > Advanced Options > HBBTV settings.

#### Switch on HbbTV

HBBTV settings > On.

#### Set the HbbTV History Tracking

HBBTV settings > Do Not Track.

Set the options according to your preference.

#### Set the HbbTV Cookies

HBBTV settings > Cookie Settings.

Set the options according to your preference.

#### Set other options

HBBTV settings > Persistent Storage, Block Tracking Sites, or Device ID.

Select one of the options and switch it to on or off.

#### Reset HbbTV Device ID

HBBTV settings > Reset Device ID.

You can reset your TV unique device identifier. A new identifier will be created. This will replace your Device ID with a new identifier.

---

## Subtitle

MENU > TV options > Advanced Options > Subtitle.

Digital channels can offer several subtitle languages for a programme. You can set a preferred primary and secondary subtitle language. If subtitles in one of these languages are available, the TV will show the subtitles you selected.

Press **SUBTITLE** key on the remote control to display the subtitle page.

---

## Teletext

MENU > TV options > Advanced Options > Teletext.

Some digital TV broadcasters have several Text languages available.

---

## OAD

MENU > TV options > Advanced Options > OAD.

Set the Over-the-air software update auto download to on or off.

Note: OAD is for Thailand, Malaysia, and Vietnam only.

---

## Postal Code

MENU > TV options > Advanced Options > Postal Code.

The Early Warning System (EWS) is to warn the general public when the natural disasters are detected within the postal code area.

The TV will display the respective warning messages/alerts when triggered by the Broadcasters.

Note: This is for Indonesia only.

---

## Auto Sleep

MENU > TV options > Advanced Options > Auto Sleep.

TV switches to sleep mode automatically after a preset time if the TV does not receive any command from remote control.

---

---

## System information

MENU > TV options > Advanced Options > System information.

To check the system information, including Signal level, Frequency, Service ID, and etc.

---

11.6

## Other settings

---

### Device Preferences

MENU > TV options > Settings > Device Preferences.

#### Keyboard

Set the on-screen keyboard type.

#### Inputs

Rename the Inputs name.

#### Storage

Check the device storage.

#### Home screen

Customize the home screen. You can enable or disable the video and audio previews. Reorder the apps and games. Read the Open-source licenses.

#### Retail mode

Switch on or of the retail mode. If you set the retail mode to on. You can set the retail message type and demo.

#### Google Assistant

Adjust the settings for Google Assistant. You can also view the Open-source licenses.

#### Chromecast built-in

Adjust the settings for Chromecast built-in. You can view the Open-source licenses and the version number.

#### Screen saver

Adjust the screen saver setting for your preference.

#### Location

Set the location status.

#### Usage & Diagnostics

Set to on for automatically send diagnostic information to Google, such as crash reports and usage data from your device, apps and Chromecast built in.

---

## Remote and Accessories

MENU > TV options > Settings > Remote and Accessories.

You can select the stored Bluetooth® connection from the list.

If you cannot find your accessory, select **Add accessory** to search for Bluetooth® connections.

---

11.7

## Reset TV Settings

Reset all settings value to original TV settings

MENU > TV options > Settings > Device Preferences > Reset.

This will erase all data from your device's internal storage, including: your Google account, system app data, download apps, and settings.

---

11.8

## Restart

MENU > TV options > Settings > Device Preferences > About > Restart

**Note:**

- Disconnect the external USB hard disc before rebooting.
- Wait for few seconds, the TV restart automatically.

This will remove unnecessary data and information in the memory.

If your TV runs low performance when using Apps, such as the video and audio are not synchronised or the App is running slow, reboot your TV for better performance.

---

11.9

## Clock, Region, and Language Settings

---

### Menu language

Change the language of the TV menu

MENU > TV options > Settings > Device Preferences > Language.

---

## Audio Language

Set audio preference language

MENU > TV options > Settings > Channel > Audio Language, Second Audio Language.

Digital TV channels can broadcast audio with several spoken languages for a programme. You can set a preferred primary and secondary audio language. If audio in one of these languages is available, the TV will switch to this audio.

---

### Subtitle Language

Digital broadcasts can have subtitles for their programmes.

Set subtitle preference language

MENU > TV options > Advanced Options > Subtitle.

Digital channels can offer several subtitle languages for a programme. You can set a preferred primary and secondary subtitle language. If subtitles in one of these languages are available, the TV will show the subtitles you selected.

Press **SUBTITLE** key on the remote control to display the subtitle page.

Set teletext preference language

MENU > TV options > Advanced Options > Teletext.

Some digital TV broadcasters have several Text languages available.

---

## Clock

MENU > TV options > Settings > Device Preferences > Date & time.

Correct clock automatically

Automatic date & time > Use network-provided time.

- The standard setting for the TV clock is automatic. The time information comes from the broadcasted UTC - Coordinated Universal Time information.

Correct clock manually

Automatic date & time > Off.



Select **Set date** and **Set time** to adjust the value.

**Note:**

- If none of the automatic settings display the time correctly, you can set the time manually.
- If you schedule recordings from the TV Guide, we recommend not to change the time and date manually.

Set time zone or set a time offset for your region

**Date & time** > **Set time zone**.

Select the time zone of your preference.

---

## Timer

Set TV switch on or off timer

**MENU** > **TV options** > **Settings** > **Device Preferences** > **Timer**.

Set **Power on time type** or **Power off type** to **On** or **Once**.

---

11.10

## Accessibility Settings

**MENU** > **TV options** > **Settings** > **Device Preferences** > **Accessibility**.

With **Audio description** switched on, the TV is prepared for use of the deaf, hard of hearing, blind or partially sighted people.

**Accessibility for blind or partially sighted people**

**Audio description** > **On**.

Digital TV channels can broadcast special audio commentary describing what is happening on screen.

**Visually impaired**

- Set the speaker, headphone volume of the normal audio with the audio commentary.
- Set the extra audio effects in the commentary audio.

**Accessibility for hearing impaired people**

**Hearing impaired** > **On**.

- Some digital TV channels broadcast special audio and subtitles adapted for the hard of hearing or deaf people.
- Switched on, the TV automatically switches to the adapted audio and subtitles, if available.

---

# Videos, Photos, Music & Text

---

## From a USB Connection

You can view your photos or play your music and videos from a connected USB flash drive.

With the TV switched on, plug in a USB flash drive to one of the USB connections.

- 1 - Press **Home**, select **MMP** from the Apps list and press **OK**.
- 2 - Use **Navigation keys** to select the file type.
- 3 - Follow the on-screen instructions to play the files.

## Play your Videos

### Play a video

- 1 - Press **Home**, select **MMP** from the Apps list and press **OK**.
- 2 - Use **Navigation keys** to select **Video**.
- 3 - Select one of the videos, and press **OK** to play.

### During the video playback...

- Press **MENU** to show the options.

### Play, Pause

Press **OK** to play or pause the video.

### Repeat

Play videos repeatedly or once.

### Show Info

Display the information of the video file.

### Screen Mode

Adjust the screen mode.

### Picture Settings

Adjust the picture settings.

### Sound Settings

Adjust the sound settings.

### Last Memory

When set to **On**, you can play the video where you left last time. Set to **Off** to turn off the function.

### Seek

Jump to the playback time as you entered.

---

# View your Photos

---

## View Photos

### View a photo

- 1 - Press **Home**, select **MMP** from the Apps list and press **OK**.
- 2 - Use **Navigation keys** to select **Photo**.
- 3 - Select one of the photos, and press **OK**.

When browsing photo thumbnails, press **MENU** to...

### Sort

Sort the photo files by your preference.

### Media type

Sort the files by media type.

### Thumbnail size

Change the thumbnail viewing size.

### Copy

Copy the file and place it to your preferred folder.

### Paste

Place the copied file to your preferred folder.

### Delete

Delete the selected file.

### Recursive parser

Select from the **Recursive parser** or **Normal parser**.

### Photo Frame

Select to start the Photo Frame mode.

---

## Photo Options

When viewing photo files, press **MENU** to...

### Play

Press **OK** to play the photos.

### Repeat

View the pictures repeatedly or once only.

### Shuffle on, Shuffle off

View the pictures in sequential order, or at random.

### Rotate

Rotate the image direction.

### Zoom

Zoom in the image.

### Show info

Display the information of the picture file.

### Photo Frame image

Set the picture as Photo Frame image.

When playing slideshow, press **MENU** to...

### Pause

Press **OK** to pause the photos.

### Repeat

View the pictures repeatedly or once only.

### Shuffle on, Shuffle off

View the pictures in sequential order, or at random.

### Duration

Set the speed of the slideshow.

### Effect

Set the transition from one picture to the next.

### Show info

Display the information of the picture file.

### Photo Frame image

Set the picture as Photo Frame image.

---

12.4

## Play your Music

### Play music

1 - Press **Home**, select **MMP** from the Apps list and press **OK**.

2 - Use **Navigation keys** to select **Audio**.

3 - Select one of the audio, and press **OK** to play.

### During the audio playback...

• Press **MENU** to show the options.

### Play, Pause

Press **OK** to play or pause the music.

### Repeat

Play music repeatedly or once.

### Shuffle On, Shuffle Off

Play audio in sequential order, or at random.

### Show Info

Display the information of the music file.

### Hide Spectrum

Hide the spectrum when play the music.

### Lyric Options

Select the options when the lyrics are available.

### Picture Off

Close the screen when play the music for energy saving.

### Sound Settings

Adjust the sound settings.

---

12.5

## View your Text

### View text

1 - Press **Home**, select **MMP** from the Apps list and press **OK**.

2 - Use **Navigation keys** to select **Text**.

3 - Select one of the text file, and press **OK** to preview.

### During the preview...

• Each file lasts 3 seconds for preview. Press **OK** to pause the preview to read.

• Press **MENU** to show the options.

### Play, Pause

Press **OK** to play or pause the text file preview.

### Repeat

Preview the text files repeatedly or once.

### Shuffle On, Shuffle Off

Preview the text files in sequential order, or at random.

### Font

Adjust the text **Size**, **Style**, and **Color**.

### Show Info

Display the information of the text file.

# TV Guide

---

## 13.1

### What You Need

With the TV Guide you can view a list of the current and scheduled TV programmes of your channels. Depending on where the TV guide information (data) is coming from, analogue and digital channels or only digital channels are shown. Not all channels offer TV Guide information.

The TV can collect TV Guide information for the channels that are installed on the TV. The TV cannot collect the TV Guide information for channels viewed from a digital receiver or decoder.

---

## 13.2

### TV Guide Data

MENU > Navigation keys up  
> Channels > Program Guide.

The TV Guide receives information (data) from broadcasters. In some regions and for some channels, TV Guide information might not be available. The TV can collect TV Guide information for the channels that are installed on the TV. The TV cannot collect the TV Guide information from channels viewed from a digital receiver or decoder.

---

# Recording and Pause TV

---

## 14.1

### Recording

---

#### What You Need

You can record a digital TV broadcast and watch it later.

To record a TV programme you need...

- a connected USB Hard Drive formatted on this TV
- digital TV channels installed on this TV
- to receive channel information for the on screen TV Guide
- a reliable TV clock setting. If you reset the TV clock manually, recordings may fail.

You cannot record when you are using Pause TV.

In terms enforcement of copyright legislation, some DVB providers can apply different restriction by means of DRM (Digital Right Management) technology. In case of broadcasting protected channels, recording, record validity or number of views may be restricted. Recording may be completely prohibited. In case of trying to record a protected broadcasting or play back an expired recording, an error message can appear.

#### Note:

Recording function is only for digital TV broadcast. It is not possible to record content from external devices (e.g. HDMI).

---

### Record a Programme

---

#### Record Now

To record the programme you are watching right now, press **Record** on the remote control. The recording will start immediately.

To stop the recording, press **Stop**.

When TV Guide data is available, the programme you are watching will be recorded from the moment you pressed the recording key until the programme ends. If no TV Guide data is available, the recording will only last 30 minutes. You can adjust the end time of the recording in the list of **Recordings**.

---

### Schedule a Recording

You can schedule a recording of an upcoming programme for today or a few days from today (maximum of 8 days away). The TV will use the data from the TV Guide to start and end the recording.

To record a programme...

- 1 - Press **MENU** > **Navigation keys down** > **Record** > **Schedule list** and press **OK**.
- 2 - Press **Record** key on the remote control.
- 3 - Follow the on-screen instruction. Use **Navigation keys** to select and set the settings.
- 4 - Select **Add** and press **OK**.

---

### List of Recordings

You can view and manage your recordings in the list of recordings.

To open the list or recordings...

- 1 - Press **MENU** > **Navigation keys down** > **Record** > **Record list** and press **OK**.
- 2 - With a recording selected in the list, you can use the colour keys to remove the recording or show the recording information.
- 3 - Press **Back** to close the menu.

Broadcasters can limit the number of days a recording can be viewed. When this period expires, the recording will be marked as expired. A recording in the list can show the number of days before it expires.

When a scheduled recording was prevented by the broadcaster or when the broadcast was interrupted, a recording is marked as **Failed**.

---

### Watch a Recording

To watch a recording...

- 1 - Press **MENU** > **Record** > **Record list** and press **OK**.
- 2 - In the list of recordings, press **OK** to play the recording.
- 3 - You can use the **Playback keys** for pause, play, rewind, fast forward, or stop.
- 4 - To switch back to watch TV, press **EXIT**.

---

## 14.2

### Pause TV

---

## What You Need

You can pause a digital TV broadcast and resume watching it a bit later.

To pause a TV programme you need...

- a connected USB Hard Drive formatted on this TV
- digital TV channels installed on this TV
- to receive channel information for the on screen TV Guide

With the USB Hard Drive connected and formatted, the TV continuously stores the TV broadcast you are watching. When you switch to another channel, the broadcast of the former channel is cleared. Also when you switch the TV to standby the broadcast is cleared.

You cannot use Pause TV when you are recording.

---

## Pause a Programme

To pause and resume a broadcast...

- To pause a broadcast, press **Pause**. A progress bar at the bottom of the screen appears briefly.
- To call up the progress bar, press **Pause** again.
- To resume watching, press **Play**.

With the progress bar on screen, press **Rewind** or press **Forward** to select from where you want to start viewing the paused broadcast. Press these keys repeatedly to change speed.

You can pause a broadcast for a maximum time span of 90 minutes.

To switch back to the live TV broadcast, press **Stop**.

---

## Replay

Since the TV stores the broadcast you are watching, you can mostly replay the broadcast for a few seconds.

To replay a current broadcast...

- 1 - Press **Pause**
- 2 - Press **Rewind**. You can press it repeatedly to select from where you want to start viewing the paused broadcast. Press these keys repeatedly to change speed. At one point you will reach the start of the broadcast storage or the maximum time span.
- 3 - Press **Play** to watch the broadcast again.
- 4 - Press **Stop** to watch the broadcast live.

# Smartphones and Tablets

---

## Google Cast

---

### What You Need

If an app on your mobile device has Google Cast, you can cast your app on this TV. On the mobile app, look for the Google Cast icon. You can use your mobile device to control what's on TV. Google Cast works on Android and iOS.

Your mobile device must be connected to the same Wi-Fi home network as your TV.

### Apps with Google Cast

New Google Cast apps come available every day. You can already try it with YouTube, Chrome, Netflix, Photowall ... or Big Web Quiz for Chromecast. See also [google.com/cast](http://google.com/cast)

Some Google Play products and features aren't available in all countries.

Find more information on [www.support.google.com/androidtv](http://www.support.google.com/androidtv)

---

## Cast to Your TV

To cast an app to the TV screen...

- 1 - On your smartphone or tablet, open an app that supports Google Cast.
- 2 - Tap the Google Cast icon.
- 3 - Select the TV you would like to cast to.
- 4 - Press play on your smartphone or tablet. What you selected should start playing on TV.

# Netflix

If you have a Netflix membership subscription, you can enjoy Netflix on this TV. Your TV must be connected to the Internet. In your region, Netflix might only come available with future software updates.

To open Netflix, press **NETFLIX** on the remote control to open the Netflix App. You can open Netflix immediately from a TV in standby.

[www.netflix.com](http://www.netflix.com)



# Amazon Prime Video

With an Amazon prime membership, you gain access to thousands of popular movies and TV show, including exclusive Prime Originals.

Press the **prime video** key on your remote control or the app icon to open the Amazon Prime Video app. Your TV must be connected to the Internet to use the app. For more information about Amazon Prime Video, please visit [www.primevideo.com](http://www.primevideo.com).

# Software

---

## Update Software

### Local Updates

You need a computer with a high-speed Internet connection and a USB flash drive to upload the software on the TV. Use a USB flash drive with at least 2GB free space. Make sure that write protection is switched off.

- 1 - Press **Home** > **Settings** > **Device Preferences** > **System update** > **Local Updates** and press **OK**.
- 2 - Follow the instructions on screen.

### Update from Internet

If the TV is connected to the Internet, you may receive a message to update the TV software. You need a high-speed (broadband) Internet connection. If you receive this message, we recommend you to carry out the update.

- 1 - Press **Home** > **Settings** > **Device Preferences** > **System update** > **Internet** and press **OK**.
- 2 - Follow the instructions on screen.

## Software Version

To view the current TV software version...

- 1 - Select **MENU** > **TV options** > **Settings** > **Device Preferences** > **About**.
- 2 - The version, release notes and creation date are shown. Also, the Netflix ESN Number is shown if available.
- 3 - Press **Back** if necessary, to close the menu.

## Open Source Licenses

To view the Open-source licenses...

- 1 - Select **MENU** > **TV options** > **Settings** > **Channel**.
- 2 - Select **Open Source Licenses** and press **OK**.
- 3 - Press **Back** if necessary, to close the menu.

# Specifications

## Environmental

### End of Use

#### Disposal of your old product and batteries

Your product is designed and manufactured with high quality materials and components, which can be recycled and reused.



When this crossed-out wheeled bin symbol is attached to a product it means that the product is covered by the European Directive 2012/19/EU.



Please inform yourself about the local separate collection system for electrical and electronic products.

Please act according to your local rules and do not dispose of your old products with your normal household waste. Correct disposal of your old product helps to prevent potential negative consequences for the environment and human health.

Your product contains batteries covered by the European Directive 2006/66/EC, which cannot be disposed with normal household waste.



Please find out for yourself about the local rules on separate collection of batteries because correct disposal will help to prevent negative consequences for the environment and human health.

## Power

Product specifications are subject to change without notice. For more specification details of this product, see [www.philips.com/TVsupport](http://www.philips.com/TVsupport)

#### Power

- Mains power: AC 110–240V +/-10%
- Ambient temperature: 5°C to 35°C

#### When testing the standby power consumption:

- Wake-On-Lan (WoWLAN) must be turned off.
- Wait at least 10 minutes to enter the stable state before the power consumption testing for standby mode.

## Operating System

Android OS:

Android Pie 9

## Reception

- Aerial input: 75 ohm coaxial (IEC75)
- Tuner bands: Hyperband, UHF, VHF
- DVB: DVB-T2
- Video playback: NTSC, SECAM, PAL
- Digital video playback: MPEG2 SD/HD (ISO/IEC 13818-2), MPEG4 SD/HD (ISO/IEC 14496-10)
- Digital audio playback (ISO/IEC 13818-3)

## Display Type

#### Diagonal screen size

- 39PHx6916: 98 cm / 39 inch

#### Display resolution

- 39PHx6916: 1366 x 768

## Display Input Resolution

#### Supported input resolution - Video

##### Resolution — Refresh rate

- 480i - 60 Hz
- 480p - 60 Hz
- 576i - 50 Hz
- 576p - 50 Hz
- 720p - 24 Hz, 25 Hz, 30 Hz, 50 Hz, 60 Hz

- 1080i – 50 Hz, 60 Hz
- 1080p – 24 Hz, 25 Hz, 30 Hz, 50 Hz, 60 Hz

**Note:**

- Video supported timings also include field/frame rate 23.976Hz, 29.97Hz and 59.94Hz
- Some resolutions may not be supported in all input sources.

**Supported input resolution – Computer (HDMI Input only)**

Resolutions (amongst others)

- 640 x 480 – 60Hz
- 800 x 600 – 60Hz
- 1024 x 768 – 60Hz
- 1280 x 800 – 60Hz
- 1280 x 960 – 60Hz
- 1280 x 1024 – 60Hz
- 1366 x 768 – 60Hz

---

19.7

## Connectivity

**TV Side**

- SERV.U: "SERV.U" is for customer service to analyze when any defect happens.
- USB 1: USB 2.0
- USB 2: USB 2.0
- Antenna (75 ohm)

**TV Rear**

- Network LAN: RJ45
- Headphones: Stereo mini-jack 3.5mm
- Digital Audio out: Optical
- HDMI 3 in: ARC
- HDMI 2 in
- HDMI 1 in
- CVBS: CVBS, Audio L/R

---

19.8

## Sound

- Sound Surround
- 5 Band Equalizer
- Output power (RMS): 16W
- Dolby® Audio
- DTS HD®

---

19.9

## Multimedia

**Connections**

- USB 2.0
- Ethernet LAN RJ-45
- Wi-Fi 802.11n (built-in)

**Supported USB file systems**

- FAT 16, FAT 32

**Playback formats**

- Containers: PS, TS, M2TS, TTS, AVCHD, MP4, M4V, MKV, ASF, AVI, 3GP, Quicktime
- Video Codecs : AVI, MKV, HEVC, H264/MPEG-4 AVC, MPEG-1, MPEG-2, MPEG-4, WMV9/VC1, VP9, HEVC (H.265)
- Audio Codecs : MP3, WAV, AAC, WMA (v2 up to v9.2), WMA-PRO (v9 and v10)
- Subtitles :
  - Formats : SRT, SUB, TXT, SMI
- Image Codecs : JPEG, GIF, PNG, BMP, HEIF
- Limitations :
  - Maximum supported total bit rate for a media file is 30Mbps.
  - Maximum supported video bit rate for a media file is 20Mbps.
  - MPEG-4 AVC (H.264) is supported up to High Profile @ L5.1.
  - H.265 (HEVC) is supported upto Main / Main 10 Profile up to Level 5.1

**Supported media server software (DMS)**

- You can use any DLNA V1.5 certified media server software (DMS class).

Performance may vary, depending on the capabilities of the mobile device and the software used.

---

# Help and Support

---

## 20.1

## Register your TV

Register your TV and enjoy a range of benefits including full support (including downloads), privileged access to information about new products, exclusive offers and discounts, the chance to win prizes and even participate in special surveys about new releases.

Go to [www.philips.com/TVsupport](http://www.philips.com/TVsupport)

## 20.2

## Troubleshooting

### Switch On and Remote Control

#### The TV does not switch on

- Disconnect the power cable from the power outlet. Wait for one minute then reconnect it.
- Make sure that the power cable is securely connected.

#### Creaking sound at startup or switch off

When you are switching the TV on, off or to standby, you hear a creaking sound from the TV chassis. The creaking sound is due to the normal expansion and contraction of the TV as it cools and warms up. This does not affect performance.

#### TV does not respond to the remote control

The TV requires some time to start up. During this time, the TV does not respond to the remote control or TV controls. This is normal behaviour. If the TV continues to be unresponsive to the remote control, you can check if the remote control is working by means of a mobile phone camera. Put the phone in camera mode and point the remote control to the camera lens. If you press any key on the remote control and you notice the infra red LED flicker through the camera, the remote control is working. The TV needs to be checked. If you do not notice the flickering, the remote control might be broken or its batteries are low. This method of checking the remote control is not possible with remote controls which are wirelessly paired with the TV.

The TV goes back to standby after showing the

### Philips startup screen

When the TV is in standby, a Philips startup screen is displayed, then the TV returns to standby mode. This is normal behaviour. When the TV is disconnected and reconnected to the power supply, the startup screen is displayed at the next startup. To switch on the TV from standby, press power key on the remote control or on the TV.

### The standby light keeps on blinking

Disconnect the power cable from the power outlet. Wait 5 minutes before you reconnect the power cable. If the blinking reoccurs, contact Philips TV Consumer Care.

---

## Channels

### No digital channels found during the installation

See the technical specifications to make sure that your TV supports digital channels in your country. Make sure that all cables are properly connected and that the correct network is selected.

### Previously installed channels are not in the channel list

Make sure that the correct channel list is selected.

---

## Picture

### No picture / distorted picture

- Make sure that the antenna is properly connected to the TV.
- Make sure that the correct device is selected as the display source.
- Make sure that the external device or source is properly connected.

### Sound but no picture

- Change to other video sources and then change back to current source, then do picture style restore in Picture settings or do Factory reset in General settings option.

### Poor antenna reception

- Make sure that the antenna is properly connected to the TV.
- Loud speakers, unearthed audio devices, neon lights, high buildings and other large objects can influence reception quality. If possible, try to improve the reception quality by changing the antenna direction or moving devices away from the TV.
- If reception on only one channel is poor, fine-tune this channel with Manual Installation.

### Poor picture from a device

- Make sure that the device is connected properly.

Make sure the device's output video setting is the highest possible resolution if applicable.

- Restore picture style or change to other picture styles.

**Picture settings change after a while**

Make sure that **Retail mode** is set to **Off**. You can change and save settings in this mode.

**A commercial banner appears**

Make sure that **Retail mode** is set to **Off**. Press **MENU > TV options > Settings > Device Preferences > Retail mode** and press **OK**.

**Picture does not fit the screen**

- Change to a different picture format.
- Change **Display mode** to **Automatic**.

**Picture position is incorrect**

- Picture signals from some devices may not fit the screen correctly. Check the signal output of the connected device.
- Change **Display mode** to **Automatic**.

**Computer picture is not stable**

- Make sure that your PC uses the supported resolution and refresh rate.
- Make sure HDMI video source is not supported HDR content.

---

## Sound

**No sound or poor sound quality**

If no audio signal is detected, the TV automatically switches the audio output off — this does not indicate malfunction.

- Make sure that the sound settings are correctly set.
- Make sure that all cables are properly connected.
- Make sure that the volume is not muted or set to zero.
- Make sure that the TV audio output is connected to the audio input on the Home Theatre System. Sound should be heard from the HTS speakers.
- Some devices may require you to manually enable HDMI audio output. If HDMI audio is already enabled, but you still do not hear audio, try changing the digital audio format of the device to PCM (Pulse Code Modulation). Refer to the documentation accompanying your device for instructions.

---

## HDMI and USB

**HDMI**

- Note that HDCP (High-bandwidth Digital Content Protection) support can delay the time taken for a TV to display content from an HDMI device.
- If the TV does not recognise the HDMI device and no picture is displayed, switch the source from one device to another and back again.
- If the picture and sound of a device connected to HDMI is distorted, connect the device to another HDMI port on TV and power reboot your source device.
- If there are intermittent sound disruptions, make sure that output settings from the HDMI device are correct.
- If you use an HDMI-to-DVI adapter or HDMI-to-DVI cable, make sure that an additional audio cable is connected to AUDIO IN (mini-jack only), if available.

**HDMI EasyLink does not work**

- Make sure that your HDMI devices are HDMI-CEC compatible. EasyLink features only work with devices that are HDMI-CEC compatible.

**No volume icon shown**

- When an HDMI-CEC audio device is connected and you use the TV Remote Control to adjust the volume level from the device, this behaviour is normal.

**Photos, videos and music from a USB device do not show**

- Make sure that the USB storage device is set to Mass Storage Class compliant, as described in the storage device's documentation.
- Make sure that the USB storage device is compatible with the TV.
- Make sure that the audio and picture file formats are supported by the TV.

**Choppy playback of USB files**

- The transfer performance of the USB storage device may limit the data transfer rate to the TV which causes poor playback.

---

## Network

**Wi-Fi network not found or distorted**

- Microwave ovens, DECT phones or other Wi-Fi 802.11b/g/n devices in your proximity might disturb the wireless network.
- Make sure that the firewalls in your network allow access to the TV's wireless connection.
- If the wireless network does not work properly in your home, try the wired network installation.

**Internet does not work**

- If the connection to the router is OK, check the router connection to the Internet.

**The PC and Internet connection are slow**

- Look in your wireless router's user manual for

information on indoor range, transfer rate and other factors of signal quality.

- Use a high-speed (broadband) Internet connection for your router.

#### DHCP

- If the connection fails, you can check the DHCP (Dynamic Host Configuration Protocol) setting of the router. DHCP should be switched on.

---

## Bluetooth®

#### Unable to pair

- Make sure the device is in pairing mode. Read the user manual of the device.
- Keep the wireless speaker as close to the TV as possible.
- Trying to pair several devices with the TV at the same time, may not work.

#### Bluetooth® lost connection

- Always position the wireless speaker within a range of 5 meters from the TV.

#### Bluetooth® Audio and Video synchronisation

- Before you purchase a wireless Bluetooth® speaker, inform yourself about its quality of Audio to Video synchronisation, commonly called 'lip sync'. Not all Bluetooth® devices perform correctly. Ask your dealer for advice.

---

## Wrong Menu Language

Change the language back to your language.

1 - Press **MENU** > **TV**

**options** > **Settings** > **Device Preferences** and press **OK**.

2 - Select on the language you need and press **OK**.

3 - Press **Back**, repeatedly if necessary, to close the menu.

---

20.3

## Online Help

To solve any Philips TV related problem, you can consult our online support. You can select your language and enter your product model number.

Go to [www.philips.com/TVsupport](http://www.philips.com/TVsupport)

On the support site you can find your country's telephone number to contact us as well as answers to frequently asked questions (FAQs). In some countries, you can chat with one of our collaborators and ask your question directly or send a question by email. You can download new TV software or the manual to read on your computer.

---

20.4

## Support and Repair

For support and repair, call the Consumer Care hotline in your country. Our service engineers will take care of a repair, if necessary.

Find the telephone number in the printed documentation that came with the TV.

Or consult our

website [www.philips.com/TVsupport](http://www.philips.com/TVsupport) and select your country if needed.

#### TV model number and serial number

You might be asked to provide the TV product model number and serial number. Find these numbers on the packaging label or on the type label on the back or bottom of the TV.

#### Warning

Do not attempt to repair the TV yourself. This may cause severe injury, irreparable damage to your TV or void your warranty.

---

# Safety and Care

---

## 21.1

### Safety

---

#### Important

Read and understand all safety instructions before you use the TV. If damage is caused by failure to follow instructions, the warranty does not apply.

---

#### Risk of Electric Shock or Fire

- Never expose the TV to rain or water. Never place liquid containers, such as vases, near the TV. If liquids are spilt on or into the TV, disconnect the TV from the power outlet immediately. Contact Philips TV Consumer Care to have the TV checked before use.
- Never expose the TV, remote control or batteries to excessive heat. Never place them near burning candles, naked flames or other heat sources, including direct sunlight.
- Never insert objects into the ventilation slots or other openings on the TV.
- Never place heavy objects on the power cord.
- Avoid force coming onto power plugs. Loose power plugs can cause arcing or fire. Ensure that no strain is exerted on the power cord when you swivel the TV screen.
- To disconnect the TV from the mains power, the power plug of the TV must be disconnected. When disconnecting the power, always pull the power plug, never the cord. Ensure that you have full access to the power plug, power cord and outlet socket at all times.

---

#### Risk of Injury or Damage to the TV

- Two people are required to lift and carry a TV that weighs more than 25 kg or 55 lbs.
- If you mount the TV on a stand, only use the supplied stand. Secure the stand to the TV tightly. Place the TV on a flat, level surface that can support the weight of the TV and the stand.
- When wall mounted, ensure that the wall mount can safely bear the weight of the TV set. TP Vision bears no responsibility for improper wall mounting that results in accident, injury or damage.
- Parts of this product are made of glass. Handle with care to avoid injury or damage.

Risk of damage to the TV !

Before you connect the TV to the power outlet, ensure that the power voltage matches the value printed on the back of the TV. Never connect the TV to the power outlet if the voltage is different.

---

#### Stability Hazards

A television set may fall, causing serious personal injury or death. Many injuries, particularly to children, can be avoided by taking simple precautions such as:

- ALWAYS ensure the television set is not overhanging the edge of the supporting furniture.
- ALWAYS use cabinets or stands or mounting methods recommended by the manufacturer of the television set.
- ALWAYS use furniture that can safely support the television set.
- ALWAYS educate children about the dangers of climbing on furniture to reach the television set or its controls.
- ALWAYS route cords and cables connected to your television so they cannot be tripped over, pulled or grabbed.
- NEVER place a television set in an unstable location.
- NEVER place the television set on tall furniture (for example, cupboards or bookcases) without anchoring both the furniture and the television set to a suitable support.
- NEVER place the television set on cloth or other materials that may be located between the television set and supporting furniture.
- NEVER place items that might tempt children to climb, such as toys and remote controls, on the top of the television or furniture on which the television is placed.

If the existing television set is going to be retained and relocated, the same considerations as above should be applied.

---

#### Risk of Batteries

- Do not ingest the battery. Chemical burn hazard.
- The remote control may contain a coin/button cell battery. If the coin/button cell battery is swallowed, it can cause severe internal burns in just 2 hours and can lead to death.
- Keep new and used batteries away from children.
- If the battery compartment does not close securely, stop using the product and keep it away from children.
- If you think batteries might have been swallowed or placed inside any part of the body, seek immediate medical attention.
- Risk of fire or explosion if the battery is replaced by an incorrect type.
- Replacement of a battery with an incorrect type that



can defeat a safeguard (for example, in the case of some lithium battery types).

- Disposal of a battery into fire or a hot oven, or mechanically crushing or cutting of a battery, that can result in an explosion.
- Leaving a battery in an extremely high temperature surrounding environment that can result in an explosion or the leakage of flammable liquid or gas.
- A battery subjected to extremely low air pressure that may result in an explosion or the leakage of flammable liquid or gas.

---

## Risk of Overheating

Never install the TV in a confined space. Always leave a space of at least 10 cm or 4 inches around the TV for ventilation. Ensure curtains or other objects never cover the ventilation slots on the TV.

---

## Lightning Storms

Disconnect the TV from the power outlet and antenna before lightning storms.

During lightning storms, never touch any part of the TV, power cord or antenna cable.

---

## Risk of Hearing Damage

Avoid using earphones or headphones at high volumes or for prolonged periods of time.

---

## Low Temperatures

If the TV is transported in temperatures below 5°C or 41°F, unpack the TV and wait until the TV temperature reaches room temperature before connecting the TV to the power outlet.

---

## Humidity

In rare occasions, depending on temperature and humidity, minor condensation can occur on the inside of the TV glass front (on some models). To prevent this, do not expose the TV to direct sunlight, heat or extreme humidity. If condensation occurs, it will disappear spontaneously while the TV is playing for a few hours.

The condensation moisture will not harm the TV or cause malfunction.

## Screen Care

- Never touch, push, rub or strike the screen with any object.
- Unplug the TV before cleaning.
- Clean the TV and frame with a soft damp cloth and wipe gently. Never use substances such as alcohol, chemicals or household cleaners on the TV.
- To avoid deformations and colour fading, wipe off water drops as quickly as possible.
- Avoid stationary images as much as possible.

Stationary images are images that remain onscreen for extended periods of time. Stationary images include onscreen menus, black bars, time displays, etc. If you must use stationary images, reduce screen contrast and brightness to avoid screen damage.

# Terms of Use

2021 © TP Vision Europe B.V. All rights reserved.

This product was brought to the market by TP Vision Europe B.V. or one of its affiliates, hereinafter referred to as TP Vision, which is the manufacturer of the product. TP Vision is the warrantor in relation to the TV with which this booklet was packaged. Philips and the Philips Shield Emblem are registered trademarks of Koninklijke Philips N.V.

Specifications are subject to change without notice. Trademarks are the property of Koninklijke Philips N.V or their respective owners. TP Vision reserves the right to change products at any time without being obliged to adjust earlier supplies accordingly.

The written material packaged with the TV and the manual stored in the memory of the TV or downloaded from the Philips website [www.philips.com/TVsupport](http://www.philips.com/TVsupport) are believed to be adequate for the intended use of the system.

The material in this manual is believed adequate for the intended use of the system. If the product, or its individual modules or procedures, are used for purposes other than those specified herein, confirmation of their validity and suitability must be obtained. TP Vision warrants that the material itself does not infringe any United States patents. No further warranty is expressed or implied. TP Vision cannot be held responsible neither for any errors in the content of this document nor for any problems as a result of the content in this document. Errors reported to Philips will be adapted and published on the Philips support website as soon as possible.

Terms of warranty - Risk of injury, damage to TV or void of warranty!

Never attempt to repair the TV yourself. Use the TV and accessories only as intended by the manufacturer. The caution sign printed on the back of the TV indicates risk of electric shock. Never remove the TV cover. Always contact Philips TV Customer Care for service or repairs. Find the telephone number in the printed documentation that came with the TV. Or consult our website [www.philips.com/TVsupport](http://www.philips.com/TVsupport) and select your country if needed. Any operation expressly prohibited in this manual, or any adjustments and assembly procedures not recommended or authorised in this manual, shall void the warranty.

Pixel characteristics

This TV product has a high number of colour pixels. Although it has effective pixels of 99.999% or more, black dots or bright points of light (red, green or blue) may appear constantly on the screen. This is a structural property of the display (within common industry standards) and is not a malfunction.

TP Vision is committed to developing, producing and marketing products that cause no adverse health effects. TP Vision confirms that, as long as its products are handled properly for their intended use, they are safe to use according to scientific evidence available today. TP Vision plays an active role in the development of international safety standards, enabling TP Vision to anticipate further developments in standardisation for early integration in its products.

# Copyrights

23.1

## HDMI

The terms HDMI and HDMI High-Definition Multimedia Interface, and the HDMI Logo are trademarks or registered trademarks of HDMI Licensing LLC in the United States and other countries.



23.2

## HEVC

Covered by one or more claims of the HEVC patents listed at [patentlist.accessadvance.com](http://patentlist.accessadvance.com).  
Future proof with advanced HEVC decoding.



23.3

## Dolby Audio

Dolby, Dolby Audio, and the double-D symbol are trademarks of Dolby Laboratories Licensing Corporation. Manufactured under license from Dolby Laboratories. Confidential unpublished works. Copyright © 1992–2021 Dolby Laboratories. All rights reserved.



23.4

## DTS-HD

For DTS patents, see <http://patents.dts.com>. Manufactured under license from DTS Licensing Limited. DTS, the Symbol, DTS and the Symbol together, DTS-HD, and the DTS-HD logo are registered trademarks or trademarks of DTS, Inc. in the United States and/or other countries. © DTS, Inc. ALL RIGHTS RESERVED.



23.5

## Wi-Fi Alliance

Wi-Fi®, the Wi-Fi CERTIFIED logo, the Wi-Fi logo are registered trademarks of the Wi-Fi Alliance.



23.6

## Kensington

(If applicable)

Kensington and Micro Saver are registered US trademarks of ACCO World Corporation with issued registrations and pending applications in other countries throughout the world.



## Other Trademarks

All other registered and unregistered trademarks are the property of their respective owners.

# Disclaimer

Disclaimer regarding services and/or software offered by third parties

Services and/or software offered by third parties may be changed, suspended, or terminated without prior notice. TP Vision does not bear any responsibility in these sorts of situations.

# Index

<b>A</b>	
Accessibility settings	33
Age Rating	11
Android Settings	23
Antenna	5
Antenna, Manual Installation	14
Apps	25
Audio Language	32
Automatic Channel Update	14
<b>B</b>	
Bluetooth	21
Bluetooth, Devices	21
Bluetooth, Remove device	21
Bluetooth, Select device	21
<b>C</b>	
Channel	10
Channel Install, Antenna	14
Channel List	10
Channel List sorting	10
Channel List, open	10
Channel Lists	10
Channel, age rating	11
Channel, Automatic Channel Update	14
Channel, Clear Channel List	15
Channel, Installation	14
Channel, Manual channel update	14
Channel, switch to a channel	10
Channel, TV guide	36
Channel, Update	14
Connectivity Guide	16
Consumer Care	47
Contact Philips	47
<b>D</b>	
Digital Text	12
Display mode	28
Disposal of TV or batteries	43
<b>E</b>	
Eco Settings	30
End of use	43
<b>H</b>	
HbbTV	12
Home	23
<b>I</b>	
Input blocked	11
Interactive TV	12
Interactive TV, about	12
<b>I</b>	
iTV	12
<b>L</b>	
Lock channel	11
<b>M</b>	
Manual Installation	14
Media	34
Media files, from a USB drive	34
<b>N</b>	
Network connection	22
Network, setting	23
Network, Wired	22
Network, Wireless	22
<b>O</b>	
Online support	47
<b>P</b>	
Parental Controls	11
Parental Rating	11
Pause TV	37
Photos, Videos and Music	34
Picture Setting	28
Picture, picture format	28
Power cable	5
Problems, Channel	45
Problems, Connection, Internet	46
Problems, Connection, Wi-Fi	46
Problems, HDMI Connection	46
Problems, Picture	45
Problems, Remote control	45
Problems, Sound	46
Problems, USB Connection	46
Problems, Wrong menu language	47
Product Fiche	43
<b>R</b>	
Radio station	10
Reception Quality	14
Recording	37
Register your product	45
Remote control, batteries	7
Repair	47
<b>S</b>	
Safety Instructions	48
Screen care	49
Search for a Channel	10
Set PIN Code	11
Software, Update	42
Sound Style	29
Sound, style setting	29
Subtitle Language	32
Support, online	47
Switching On	9
<b>T</b>	
Teletext	12
Test Reception	14
Text	12
Text language, Primary	12
Text language, Secondary	12
Troubleshooting	45
TV Guide	36
TV Guide Data	36
TV placement	5
TV, standby	9
<b>U</b>	
USB Hard Drive, disk space	18

## V

Viewing distance	5
------------------	---

## W

Watch TV	10
Wi-Fi	22
Wired connection	22
Wireless connection	22



All registered and unregistered trademarks are property of their respective owners.  
Specifications are subject to change without notice.  
Philips and the Philips' shield emblem are trademarks of Koninklijke Philips N.V. and are used under license from Koninklijke Philips N.V.  
This product has been manufactured by and is sold under the responsibility of TP Vision Europe B.V., and TP Vision Europe B.V. is the warrantor in relation to this product.  
2022©TP Vision Europe B.V. All rights reserved.

[www.philips.com/welcome](http://www.philips.com/welcome)