

Register your product and get support at  
[www.philips.com/welcome](http://www.philips.com/welcome)

5231 series

**PHILIPS**



English - Read the safety instructions.

Български - Прочетете инструкциите за безопасност.

Čeština - Přečtěte si bezpečnostní pokyny.

Hrvatski - Pročitajte sigurnosne upute.

Dansk - Læs sikkerhedsforskrifterne.

Deutsch - Lesen Sie die Sicherheitshinweise.

Ελληνικά - Διαβάστε τις οδηγίες ασφαλείας.

Eesti - Lugege ohutusnõudeid.

Español - Lea las instrucciones de seguridad.

Français - Lisez les consignes de sécurité.

Gaeilge - Léigh na treoracha sábháilteachta.

Bahasa Indonesia - Baca petunjuk keselamatan.

Italiano - Leggere le istruzioni di sicurezza.

Қазақша - Қорғаныстық нұсқаулар.

Latviešu - Izlasiet drošības norādījumus.

Lietuvių - Perskaitykite saugos instrukcijas.

Македонски - Прочитајте ги безбедносните инструкции.

Magyar - Olvassa el a biztonsági utasításokat.

Bahasa Malaysia - Baca arahan keselamatan.

Nederlands - Lees de veiligheidsvoorschriften.

Norsk - Les sikkerhetsforskriftene.

Polski - Zapoznaj się z instrukcjami bezpieczeństwa.

Português - Leia as instruções de segurança.

Română - Citiți instrucțiunile de siguranță.

Русский - Читайте инструкции по технике безопасности.

Srpski - Pročitajte bezbednosna uputstva.

Slovenščina - Preberite varnostna navodila.

Slovenský - Prečítajte si bezpečnostné pokyny.

Suomi - Lue turvaohjeet.

Svenska - Läs säkerhetsinstruktionerna.

ภาษาไทย - โปรดอ่านคำแนะนำด้านความปลอดภัย

Türkçe - Güvenlik talimatlarını okuyun.

Українська - Читайте інструкції з техніки безпеки.

Қыргызча - Коопсуздук техникасы боюнча нускаманы окуңуз.

Tiếng Việt - Hãy đọc chỉ dẫn an toàn.

简体中文 - 请阅读安全说明。

繁體中文 - 請閱讀安全說明。

العربية قراءة تعليمات السلامة.

עברית קראו את הוראות הבטיחות

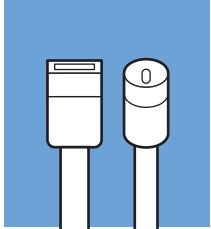

[www.philips.com/connectivityguide](http://www.philips.com/connectivityguide)

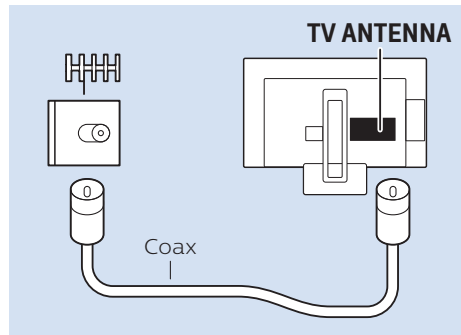
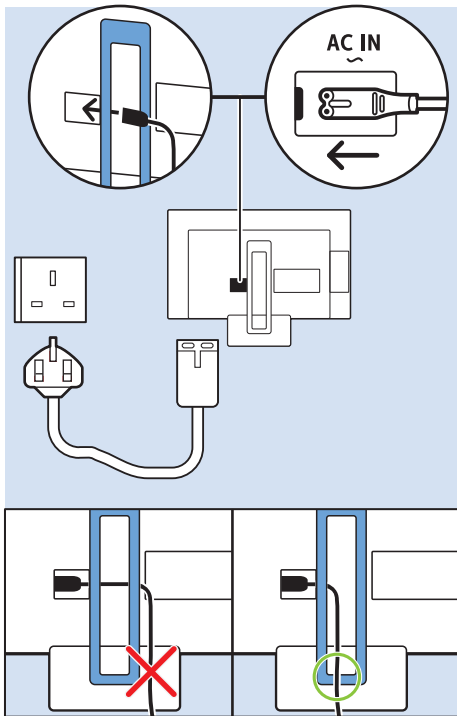

### Network - Wired (Freeview)

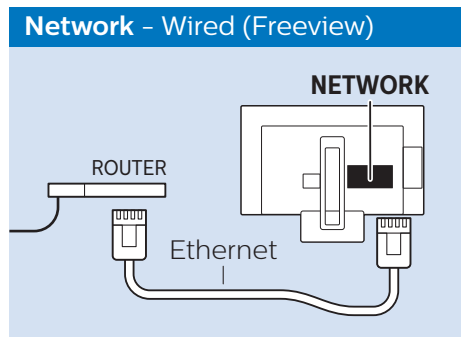

## Common Interface

### COMMON INTERFACE

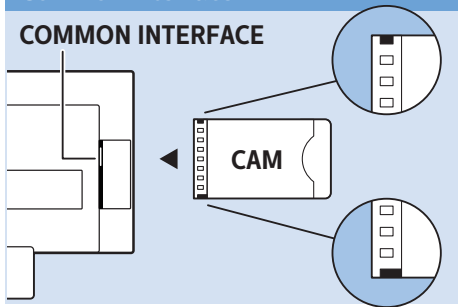

## USB Hard Drive

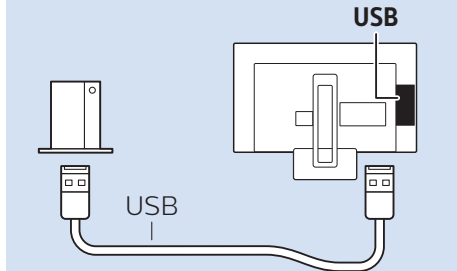

## Home Theatre System - ARC

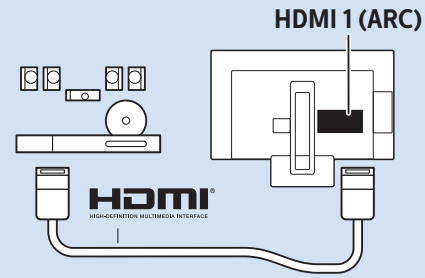

## Headphones

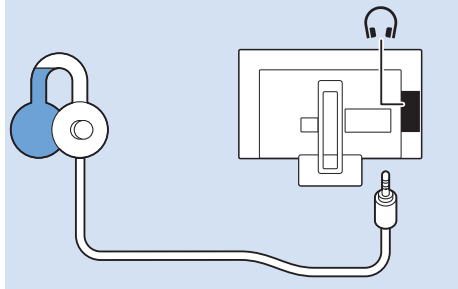

## Photo Camera

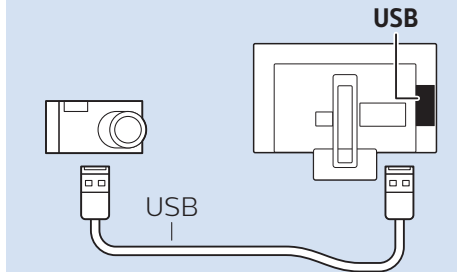

## Home Theatre System

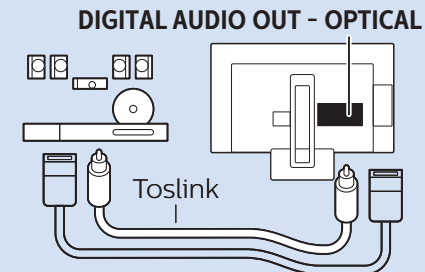

## DVD Player

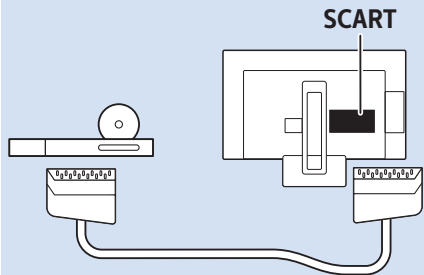

## Computer - VGA

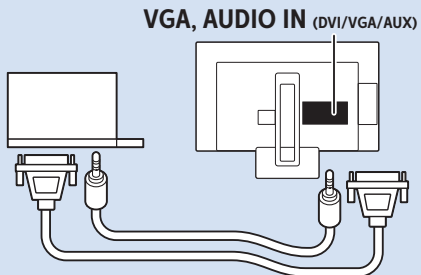

## AUX

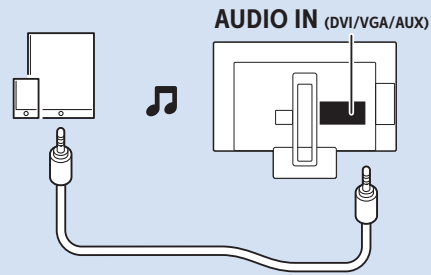

## Computer - HDMI

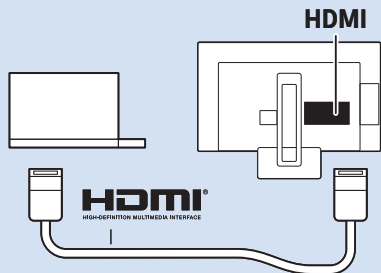

## Computer - DVI

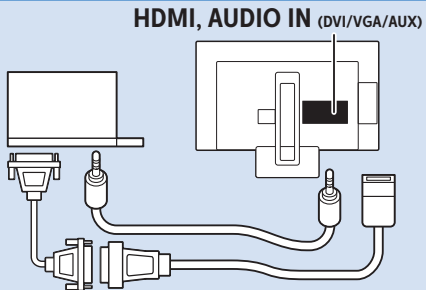

## Bluetooth



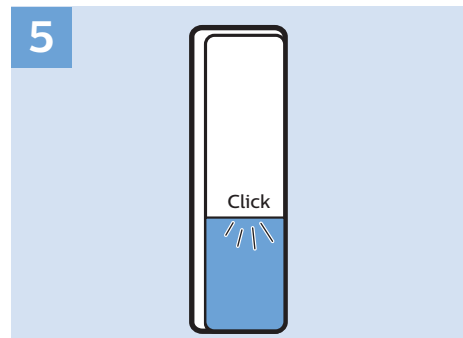
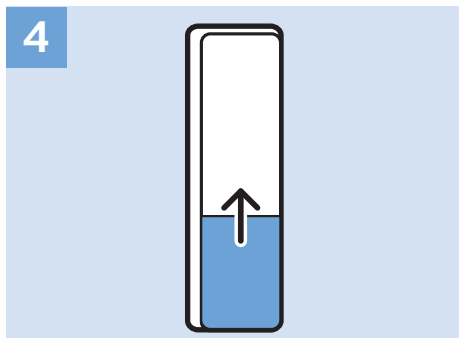
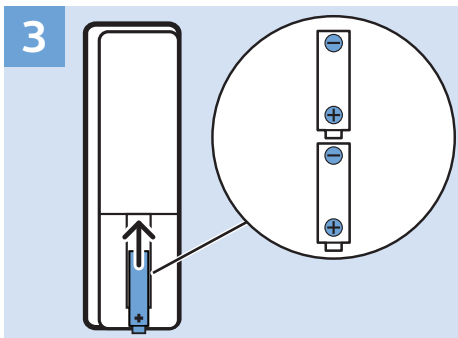
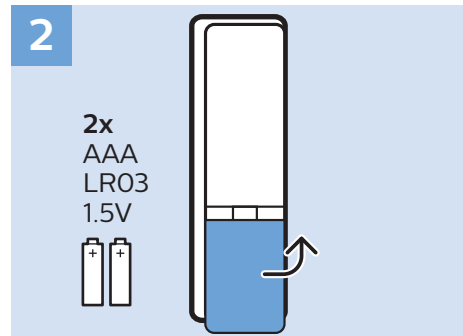
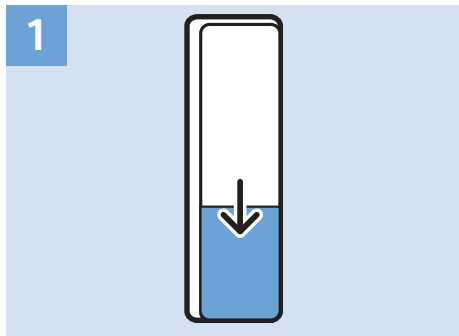
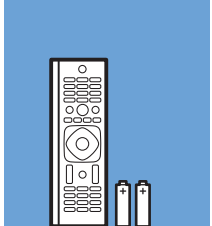

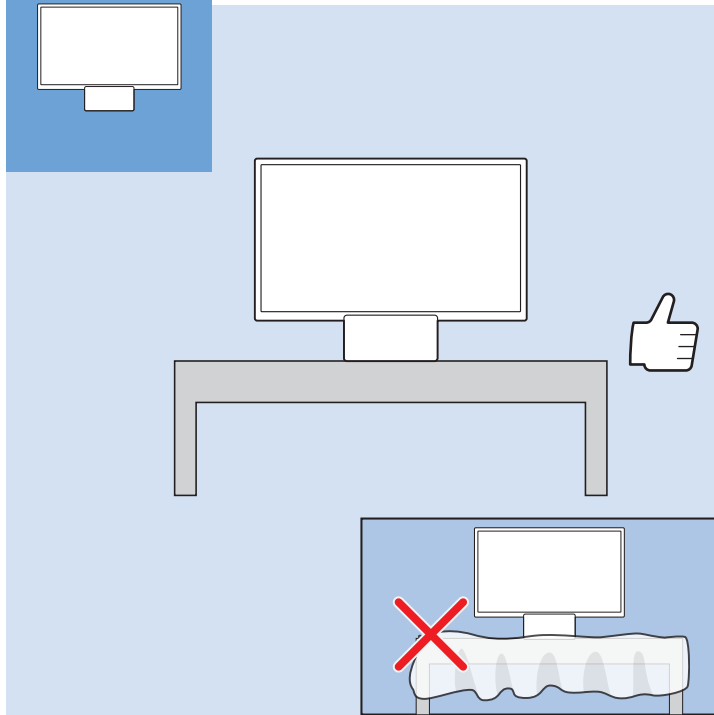
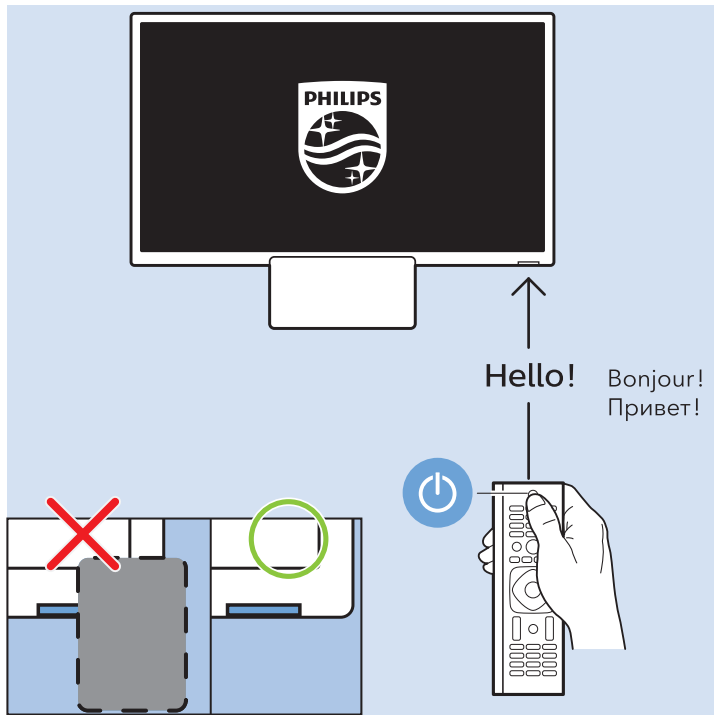

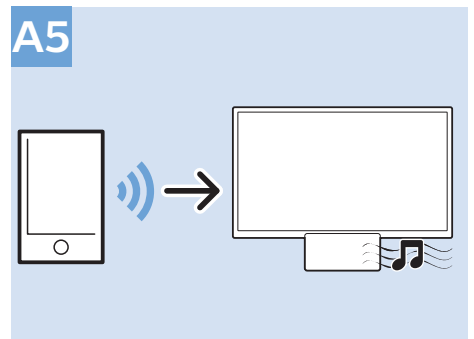
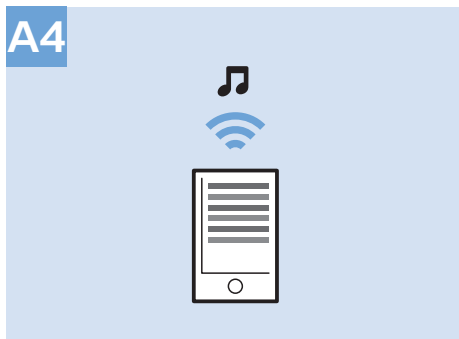
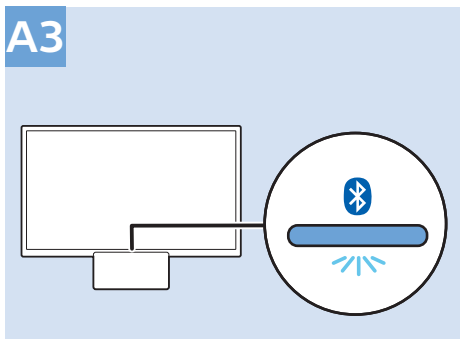
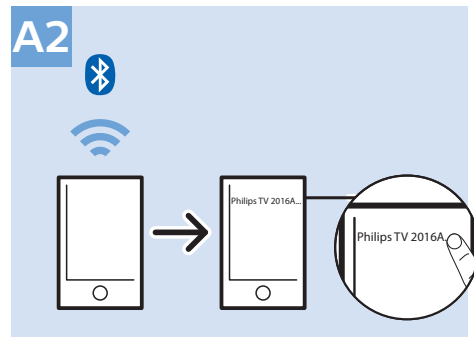
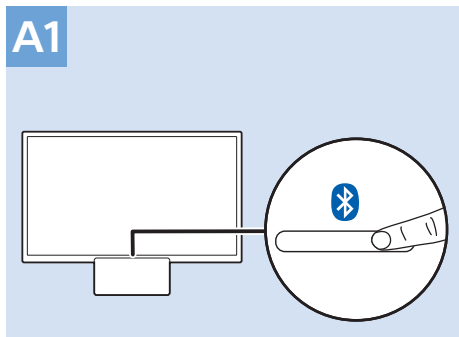
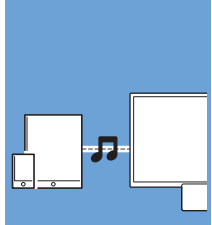



B1

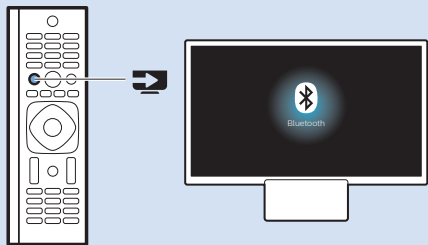

B2

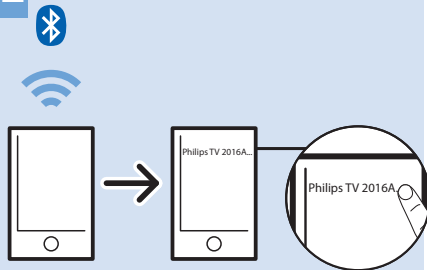

B3



B4

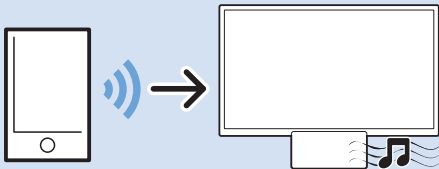

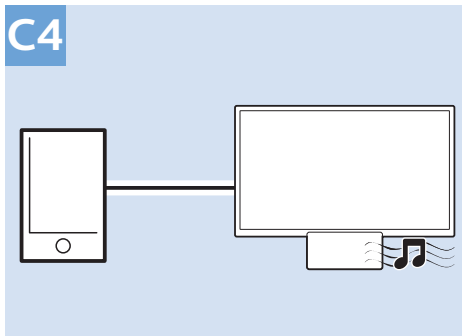
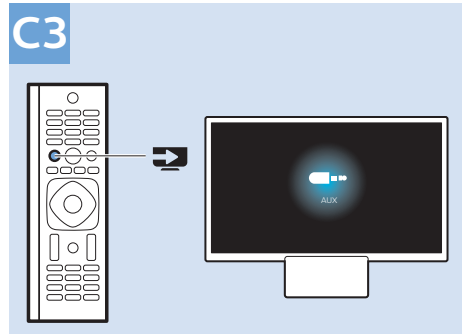
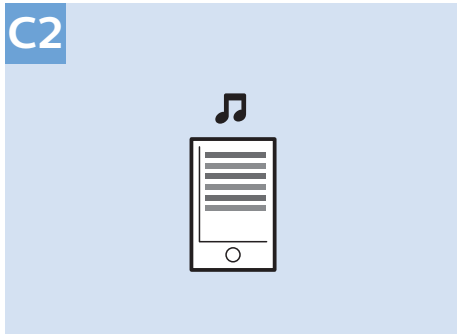
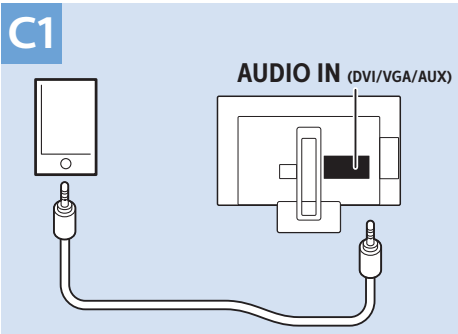



Help | Hilfe | Aide  
Guida | Ayuda  
Помощь | Yardım  
Руководство

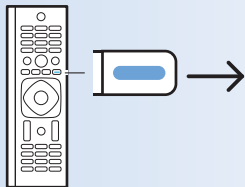

[philips.com/support](https://philips.com/support)



5231 Series  
User Manual

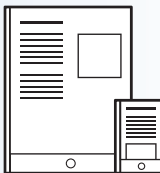

**Հայաստան - Armenia**  
Հաճախորդների սպասարկում  
**0 800 01 004**  
փոխանցված 0,03€/ min

**Azərbaycan - Azerbaijan**  
Müştəri xidmətləri  
**088 220 00 04**  
Köçürüldü zəng edin 0,17€/min

**Кыргызстан**  
Байланыш борбору  
**810 800 2000 00 04**

**България**  
Грижа за клиента  
**02 4916 273**  
(Национален номер)

**België/Belgique**  
Klantenservice/  
Service Consommateurs  
**02 700 72 62**  
(0.15€/min.)

**Bosna i Hercegovina**  
Potpora potrošačima  
**033 941 251**  
(Lokalni poziv)

**Republika Srbija** Potpora  
potrošačima  
**011 321 6840**  
(Lokalni poziv)

**Česká republika**  
Zákaznická podpora  
**228 880 895**  
(Místní tarif)

**Danmark**  
Kundeservice  
**3525 8314**

**Deutschland**  
Kundendienst  
**069 66 80 10 10**  
(Zum Festnetztarif Ihres  
Anbieters)



User Manual



FAQ



Chat



Forum



Call



Email



Warranty

[www.philips.com/support](http://www.philips.com/support)

← A - I

Ελλάδα

Τμήμα καταναλωτών

2111983028

(Διεθνής κλήση)

Eesti

Klienditugi

668 30 61

(Kohalikud kõned)

España

Atención al consumidor

913 496 582

(0,10€ + 0,08€/min.)

France

Service Consommateurs

01 57 32 40 50

(soit d'un appel local sauf  
surcoût éventuel selon opérateur  
réseau)

Қазақстан Республикасы

байланыс орталығы

810 800 2000 00 04

(стационарлық нөмірлерден

Қазақстан Республикасы бойынша  
қоңырау шалу тегін)

Hrvatska

Potpora potrošačima

01 777 66 01

(Lokalni poziv)

Indonesia

Consumer Care

0800 133 3000

Ireland

Consumer Care

015 24 54 45

(National Call)

Italia

Servizio Consumatori

0245 28 70 14

(Chiamata nazionale)

Latvija

Klientu atbalsts

6616 32 63

(Vietēiais tarifs)

Lietuva

Klientų palaikymo tarnyba

8 521 402 93

(Vietiniais tarifais)

Luxembourg

Service Consommateurs

2487 11 00

(Appel nat./ (Nationale Ruf)

Magyarország

Ügyfélszolgálat

(061) 700 81 51

(Belföldi hívás)

Malaysia

Consumer Care

1800 220 180

Österreich

Kundendienst

0150 284 21 40

(0,05€/Min.)

Республика Беларусь

Контакт Центр

8 10 (800) 2000 00 04

(бесплатный звонок по  
Республике Беларусь со  
стационарных номеров)

Российская Федерация

Контакт Центр

8 (800) 220 00 04

(бесплатный звонок по России)

Polska

Wsparcie Klienta

22 397 15 04

(Połączenie lokalne)

Nederland

Klantenservice

0900 202 08 71

(1€/gesprek)

Norge

Forbrukerstøtte

22 97 19 14

Slovenija

Skrb za potrošnike

01 88 88 312

(Lokalni klic)

Slovensko

Zákaznícka podpora

02 332 154 93

(vnútroštátny hovor)

Suomi

Finland Kuluttajapalvelu

09 88 62 50 40

Portugal

Assistência a clientes

800 780 068

(0,03€/min. – Móvel 0,28€/min.)

România

Serviciul Clienti

031 630 00 42

(Tarif local)

Schweiz/Suisse/Svizzera

Kundendienst/Service

Consommateurs/Servizio

Consumatori

0848 000 291

(0,04 CHF/Min)

Sverige

Kundtjänst

08 57 92 90 96

Türkiye

Tüketici Hizmetleri

0 850 222 44 66

Україна

Служба підтримки  
споживачів

0-800-500-480

(дзвінки зі стаціонарних і  
мобільних телефонів у межах України  
безкоштовні)

United Kingdom

Consumer Care

020 79 49 03 19

(5p/min BT landline)

Argentina

Consumer Care

0800 444 77 49

- Buenos Aires

0810 444 7782

Brasil

Suporte ao Consumidor

0800 701 02 45

- São Paulo

29 38 02 45



All registered and unregistered trademarks are property of their respective owners. Specifications are subject to change without notice. Philips and the Philips' shield emblem are trademarks of Koninklijke Philips N.V. and are used under license from Koninklijke Philips N.V.

2016 © TP Vision Europe B.V. All rights reserved.

[philips.com](http://philips.com)