

제품 등록 및 지원
www.philips.com/TVsupport

7133 series

PHILIPS



English Read the safety instructions.

한국어 안전 지침 읽기

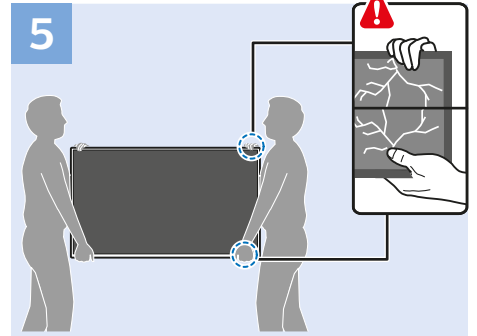
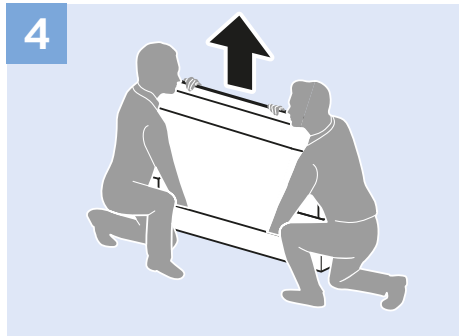
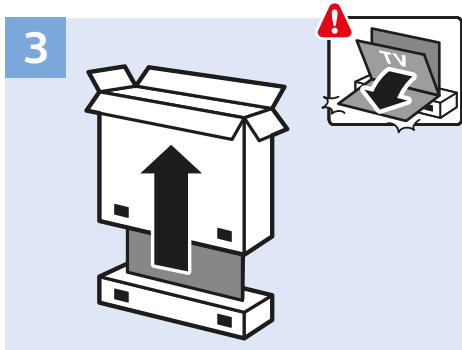
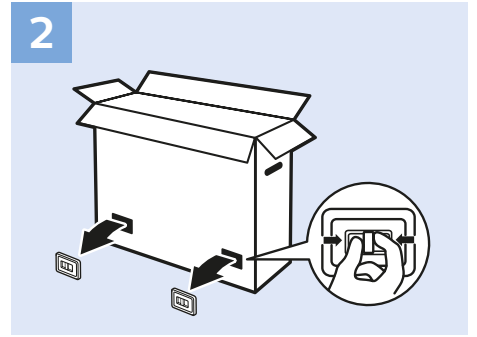
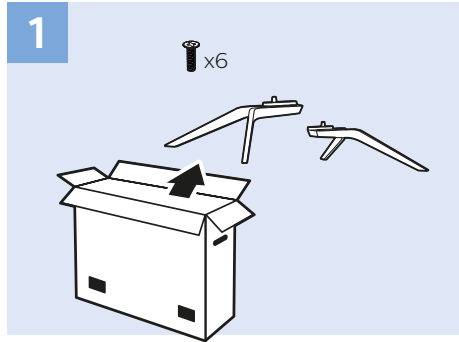
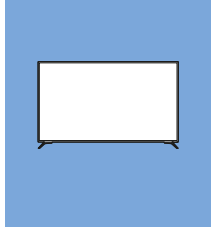

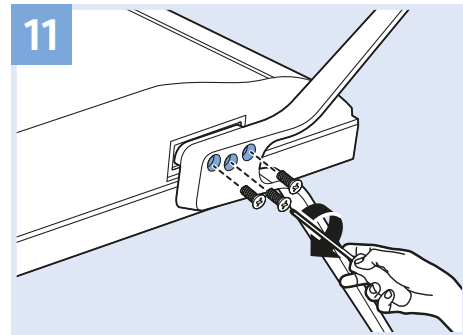
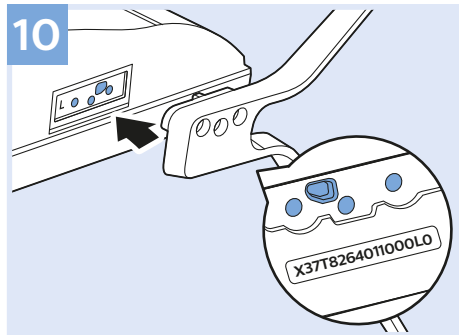
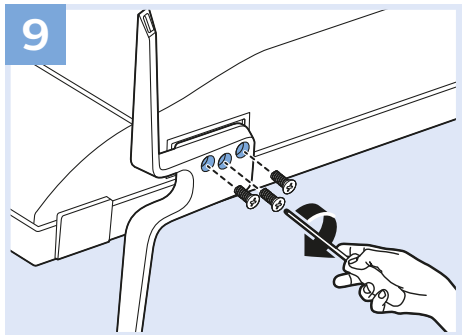
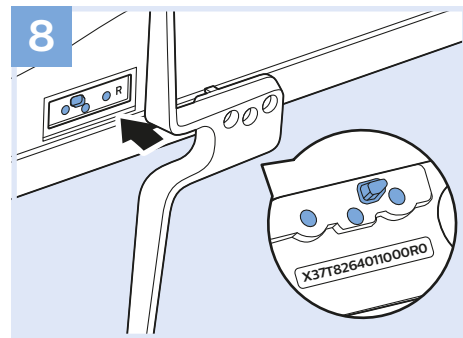
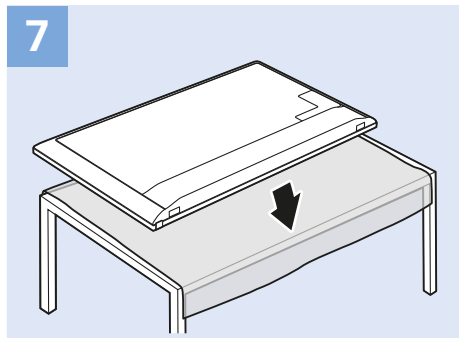
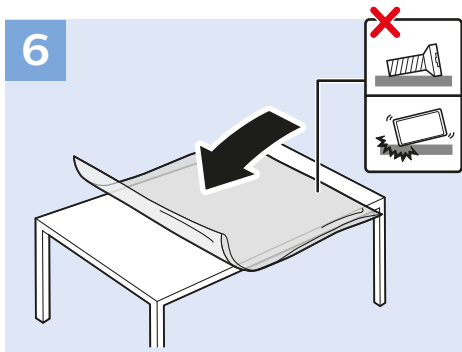

12

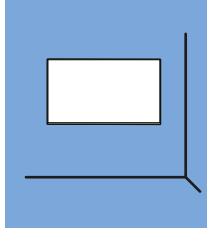
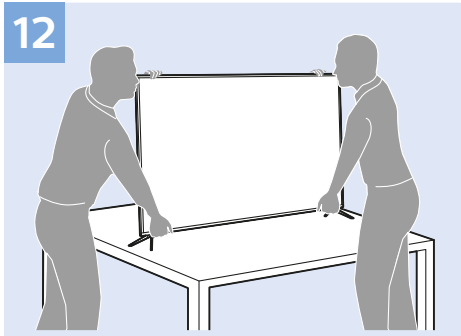

75"

VESA (x, y) 400x400 mm M8



13

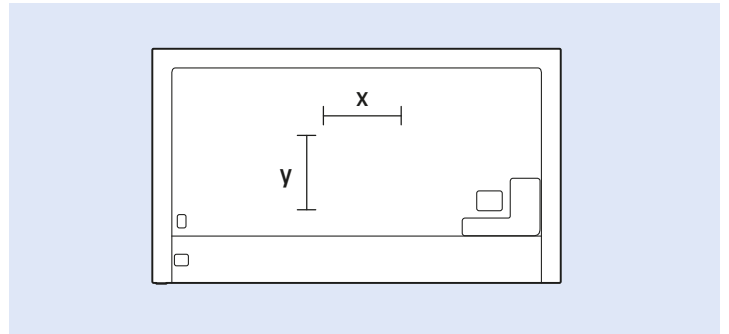
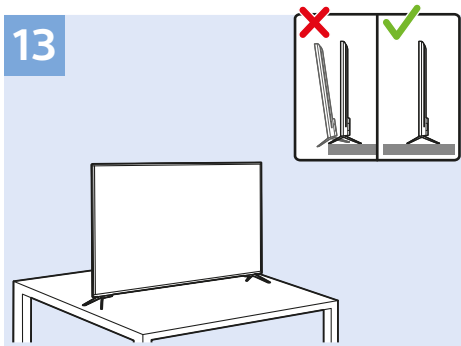

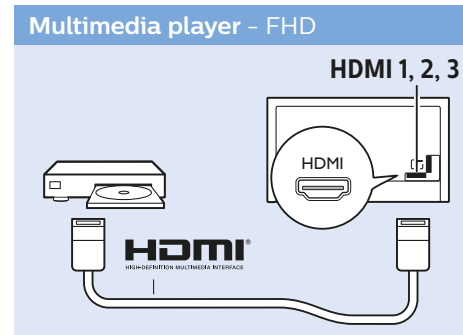
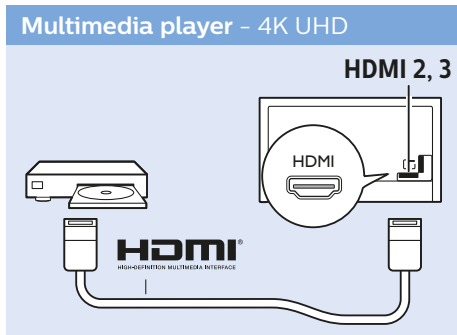
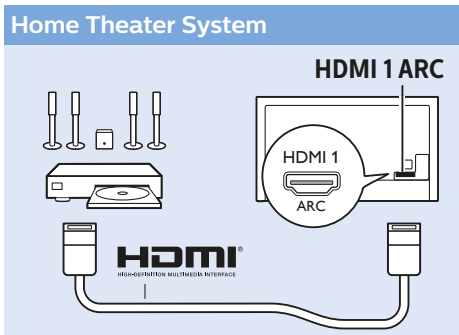
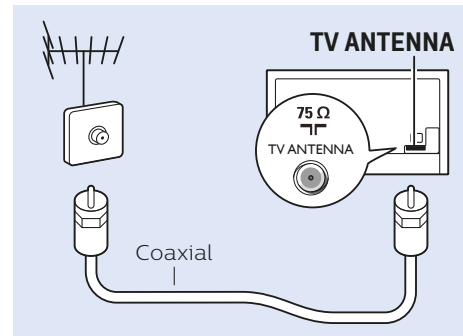
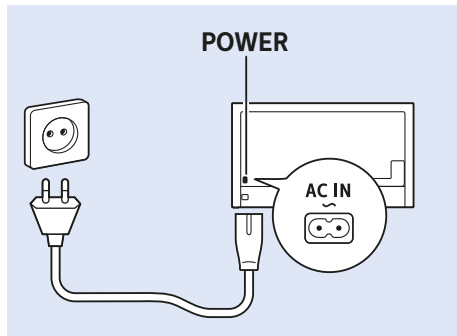
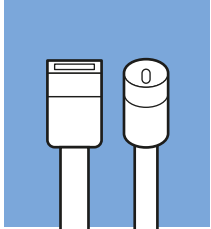

MHL

HDMI 3 MHL

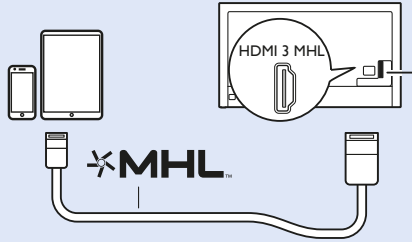

Network - Wireless

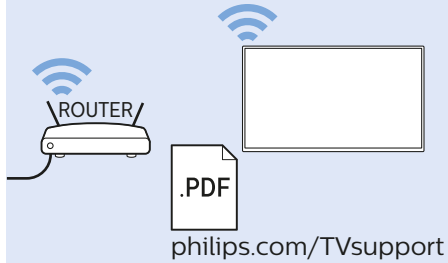

Network - Wired

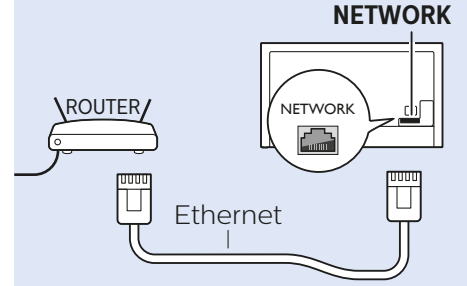

Computer - HDMI

HDMI 1, 2, 3

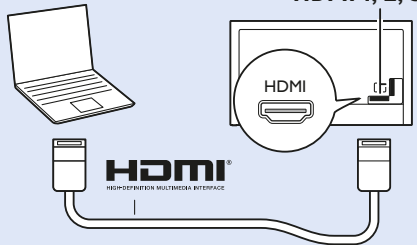

Video Player - YPbPr, L/R

Y/Pb/Pr, L/R

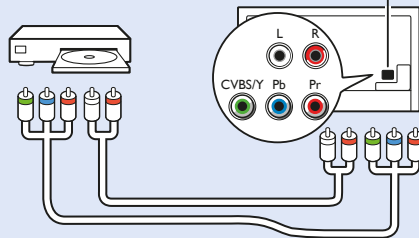

Video Player - CVBS, L/R

CVBS, L/R

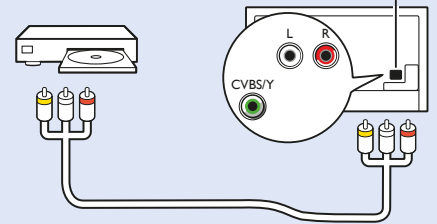

Digital Audio System - HDMI ARC

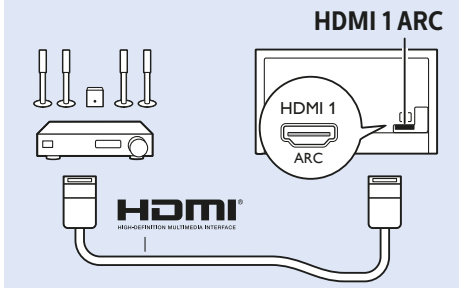

Digital Audio System - OPTICAL

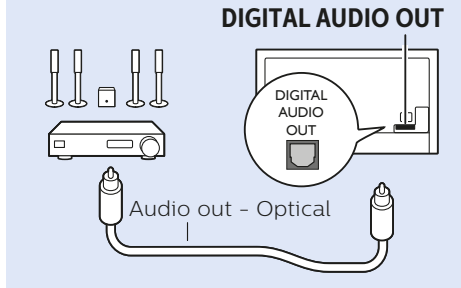

Headphones

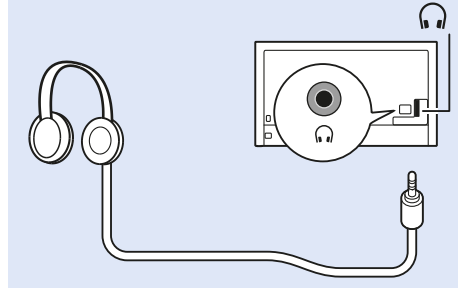

USB Hard Drive

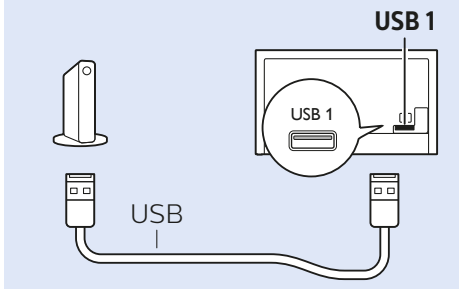

USB Flash Drive

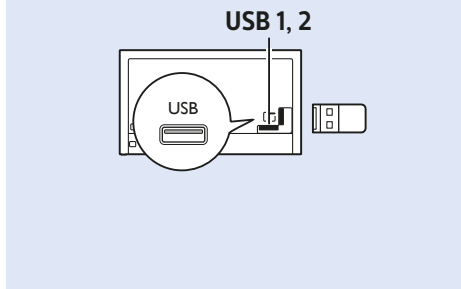
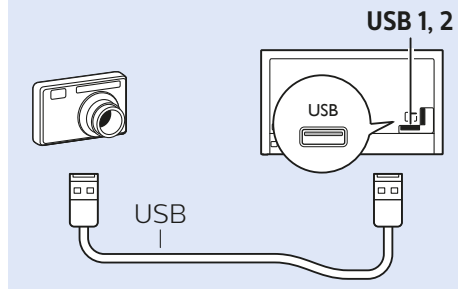
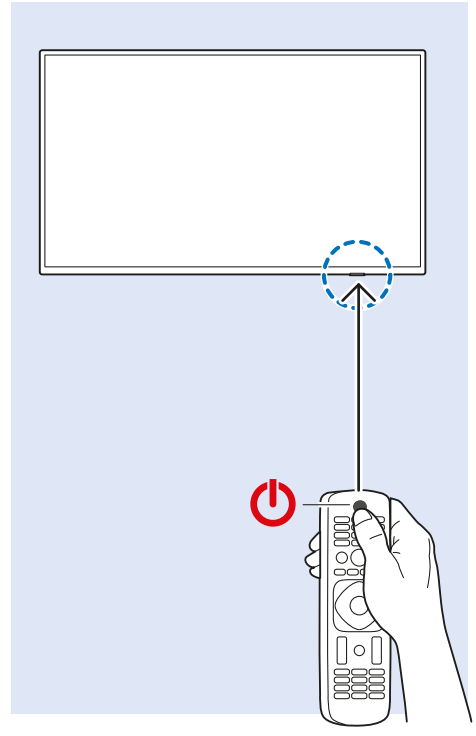
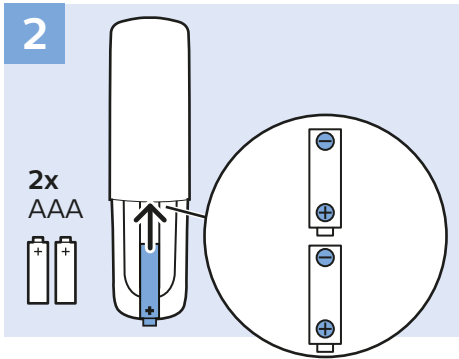
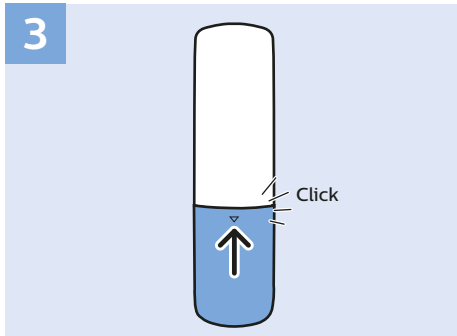
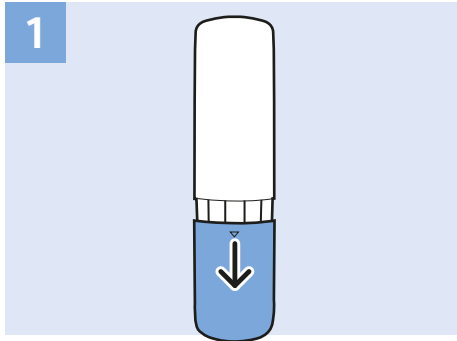
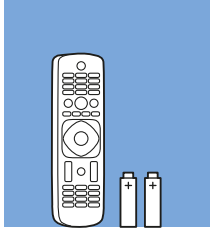
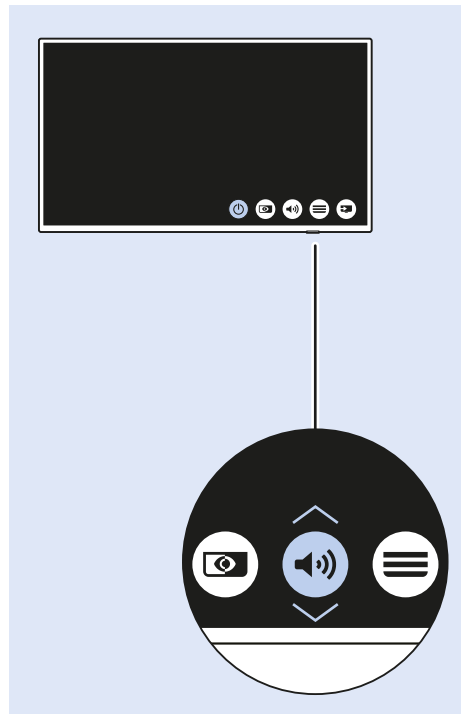
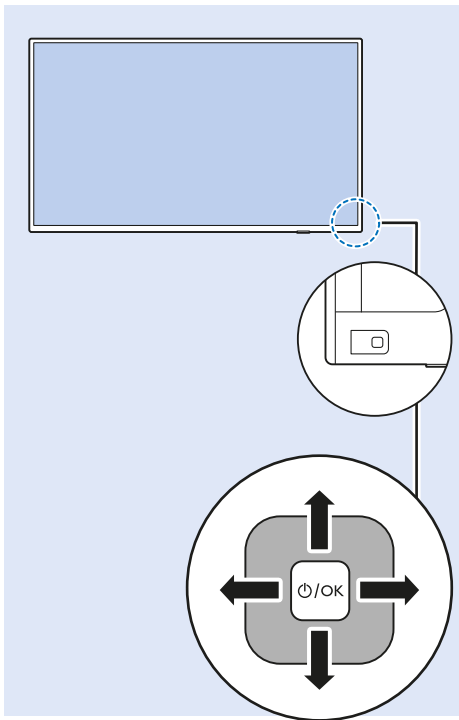
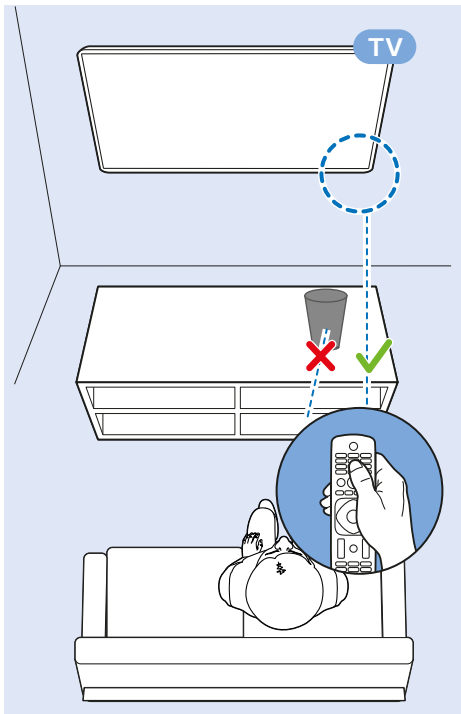
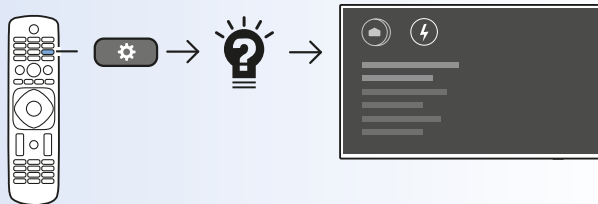
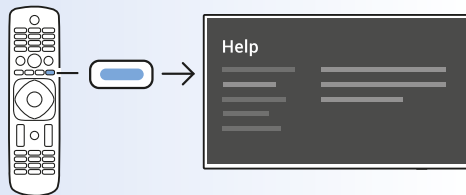

Photo Camera









www.philips.com/TVsupport





All registered and unregistered trademarks are property of their respective owners.
Specifications are subject to change without notice.
Philips and the Philips' shield emblem are trademarks of Koninklijke Philips N.V.
and are used under license from Koninklijke Philips N.V.
2018 © TP Vision Europe B.V. All rights reserved.

[philips.com](https://www.philips.com)