

Register your products and get support at  
[www.philips.com/welcome](http://www.philips.com/welcome)

1335D Series



---

User Manual

**PHILIPS**

# CONTENTS

---

1	Notice	2
---	--------	---

---

2	Important	3
---	-----------	---

---

3	TV Introduction	5
	Control Panel	5
	Remote control	6
	Use the remote control	7

---

4	Use your TV	7
	Turn the TV on/off/to standby	7
	Switch channels	8
	Watch a connected device	8
	Adjust TV volume	9

---

5	More functions	9
	Access TV menus	9
	Change language	9
	Change picture and sound settings	10
	Change other settings	11
	Use timers	12
	Use TV locks	12
	USB functions	13

---

6	Install channels	15
	Automatically search channels	15
	ATV manual tuning	15
	DTV manual tuning	15
	DTV programme guide	16
	Edit channels	16
	software Upgrade	16

---

---

7	Connect devices	16
	Back connectors	16
	Side connectors	18
	Connect a PC	18
	Use Philips EasyLink	19

---

8	Product information	20
	Supported display resolutions	20
	Tuner/Reception/ Transmission	20
	Remote control	20
	Power	20
	Supported TV mounts	21
	Product specification	21

---

9	Troubleshooting	22
	General	22
	Picture	22
	Sound	23
	HDMI connection	23
	Computer connection	23
	Contact us	23

# 1 Notice

2013 © Koninklijke Philips N.V.

All rights reserved.

Specifications are subject to change without notice. Trademarks are the property of Koninklijke Philips N.V. or their respective owners. TPV Technology Co., Ltd. reserves the right to change products at any time without being obliged to adjust earlier supplies accordingly.

The material in this Manual is believed adequate for the intended use of the system. If the product, or its individual modules or procedures, are used for purposes other than those specified herein, confirmation of their validity and suitability must be obtained. TPV Technology Co., Ltd. warrants that the material itself involves no infringement of any United States patents. No further warranty, express or implied, is made.

TPV Technology Co., Ltd. cannot be held responsible neither for any errors in the content of this document nor for any problems as a result of the content in this document. Errors reported to Philips will be adapted and published on the support website of TPV Technology Co., Ltd..

## Pixel characteristics

This LED product has a high number of color pixels. Although it has effective pixels of 99.999% or more, black dots or bright dots

(red, green or blue) may appear constantly on the screen. This is a structural property of the display (complied with common industry standards) and is not a malfunction.

## Warranty

No components are user serviceable. Do not open or remove covers to expose the inside of the product. Repairs may only be done by Philips Service Centers and official repair shops. Failure to do so shall void any warranty, stated or implied.

Any operation expressly prohibited in this Manual, or any adjustments or assembly procedures not recommended or authorized in this Manual shall void the warranty.

## Copyright

All other registered and unregistered trademarks are the property of their respective owners.

® Kensington and Micro Saver are registered US trademarks of ACCO World Corporation with issued registrations and pending applications in other countries/regions throughout the world. Portions of this software are copyright© The FreeType Project ([www.freetype.org](http://www.freetype.org)).



HDMI, the HDMI logo and the high-definition multimedia interface are the trademarks or registered trademarks of HDMI Licensing LLC.

Philips and the Philips shield logo are registered trademarks of Koninklijke Philips

N.V., the use of which is subject to licensing by Koninklijke Philips N.V.

## 2 Important

Read and understand all instructions before you use your TV. If damage is caused by failure to follow these instructions, the warranty will not apply.

---

### Safety

#### Risk of electric shock or fire!

- Never expose the TV to rain or water. Never place liquid containers, such as vases, near the TV. If liquids are spilt on or into the TV, disconnect the TV from the power outlet immediately. Contact Philips Consumer Care to have the TV checked before use.
- Never place the TV, remote control or batteries near naked flames or other heat sources, including direct sunlight. To prevent the spread of fire, keep candles or other flames away from the TV, remote control and batteries at all times.



- Never insert objects into the ventilation slots or other openings on the TV.
- When the TV is swiveled, ensure that no strain is exerted on the power cord.

Strain on the power cord can loosen connections and cause arcing.

#### Risk of short circuit or fire!

- Never expose the remote control or batteries to rain, water or excessive heat.
- Avoid force coming onto power plugs. Loose power plugs can cause arcing or fire.

#### Risk of injury or damage to the TV!

- Two people are required to lift and carry a TV that weighs more than 25kg.
- When stand mounting the TV, use only the supplied stand. Secure the stand to the TV tightly. Place the TV on a flat and level surface that can support the combined weight of the TV and the stand.
- When wall mounting the TV, use only a wall mount that can support the weight of the TV. Secure the wall mount to a wall that can support the combined weight of the TV and wall mount. TPV Technology Co., Ltd. bears no responsibility for any accident, injury or damage caused by improper mounting.

#### Risk of injury to children!

Follow these precautions to prevent the TV from toppling over and causing injury to children:

- Never place the TV on a surface covered by a cloth or other material that can be pulled away.
- Ensure that no part of the TV hangs over the edge of the supporting surface.
- Never place the TV on tall furniture (such as a bookcase) without anchoring both the furniture and TV to the wall or

a suitable support.

- Educate children about the dangers of climbing on furniture to reach the TV.

#### **Risk of battery ingestion!**

- This product/remote control may contain coin-size batteries that may be ingested by children. Please keep the batteries out of the reach of children.

#### **Risk of overheating!**

- Never install the TV in a confined space. Always leave a space of at least 4 inches or 10cm around the TV for ventilation. Ensure curtains or other objects never cover the ventilation slots on the TV.

#### **Risk of damage to the TV!**

- Before you connect the TV to the power outlet, ensure that the power voltage matches the value printed on the back of the TV. Never connect the TV to the power outlet if the voltage is different.

#### **Risk of injury, fire or power cord damage!**

- Never place the TV or any objects on the power cord.
- To easily disconnect the TV power cord from the power outlet, ensure that you have full access to the power cord at all times.
- When you disconnect the power cord, always pull the plug, never the cable.
- Disconnect the TV from the power outlet and antenna before lightning storms. During lightning storms, never touch any part of the TV, power cord or antenna cable.

#### **Risk of hearing damage!**

- Avoid using earphones or headphones at high volumes or for prolonged periods of time.

#### **Low temperatures**

- If the TV is transported in temperatures below 5°C, unpack the TV and wait until the TV warms up to the room temperature before connecting the TV to the power outlet.

---

#### **Screen care**

- Avoid stationary images. Stationary images are images that remain on-screen for extended periods of time. Examples include: on-screen menus, black bars and time displays. If you must use stationary images, reduce screen contrast and brightness to avoid screen damage.
- Unplug the TV before cleaning.
- Clean the TV and frame with a soft, damp cloth. Never use substances such as alcohol, chemicals or household cleaners on the TV.
- Risk of damage to the TV screen! Never touch, push, rub or strike the screen with any object.
- To avoid deformations and color fading, wipe off water drops as soon as possible.

---

#### **Disposal of your old product and batteries**



Your product is designed and manufactured with high quality materials and components, which can be recycled and reused.



When this crossed-out wheeled-bin symbol is attached to a product, it means that the product is covered by the European Directive 2002/96/EC. Please inform yourself about the local separate collection system for electrical and electronic products. Please act according to your local rules and do not dispose of your old product with your normal household waste. Correct disposal of your old product helps to prevent potential negative consequences for the environment and human health.



Your product contains batteries covered by the European Directive 2006/66/EC, which cannot be disposed of with normal household waste. Please inform yourself about the local rules on separate collection of batteries because correct disposal helps to prevent negative consequences for the environmental and human health.

## 3 TV Introduction

Congratulations on your purchase and welcome to Philips! To fully benefit from the support that Philips offers, register your TV at [www.philips.com/welcome](http://www.philips.com/welcome)

## Control Panel

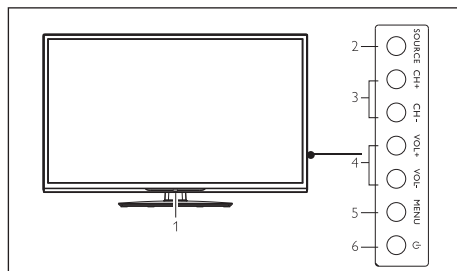

- ① Indicators/remote control receiver window.
- ② **SOURCE:** Press this button to display the list of different signal sources.
- ③ **CH+/-:** Switches to the next or previous channel.
- ④ **VOL+/-:** Increases or decreases volume.
- ⑤ **MENU:** Opens or closes main menu.
- ⑥ **⏻:** Powers on/off your product. Disconnect the power plug to fully de-energize your product.

## Remote control

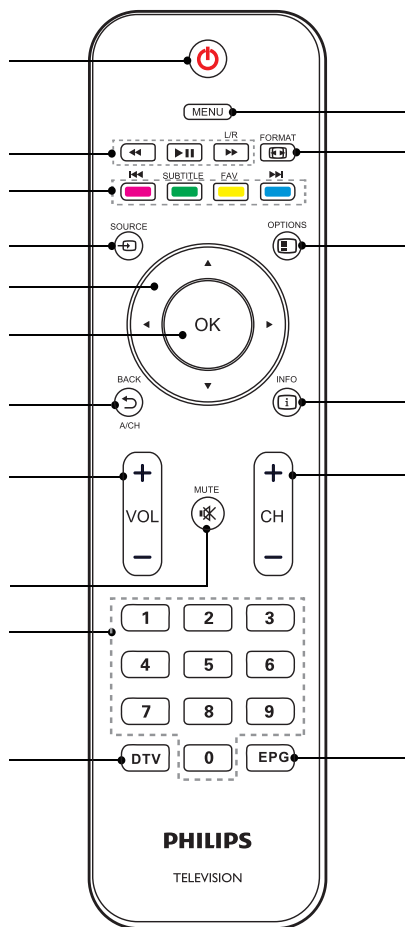

- ① **Standby/Power on**
  - Switches the TV to standby if it is on.
  - Powers on the TV if it is in standby.
- ② **Play button**  
Controls multimedia playback.
- ③ **Color buttons**  
Provides multiple special functions.

- ④ **SOURCE**  
Opens or closes source menu; selects the source to be connected.
- ⑤ **Navigation buttons**
  - Navigates menus.
- ⑥ **OK**
  - Confirms an entry or selection in menu mode.
- ⑦ **BACK**  
Returns to the previous channel or exits the current menu.
- ⑧ **VOL+/-**  
Increases or decreases volume.
- ⑨ **MUTE**  
Mutes or restores audio.
- ⑩ **0-9 Numeric buttons**  
Selects a channel or enter a desired channel number.
- ⑪ **DTV**  
Gives instant access to digital sources.
- ⑫ **EPG**  
Gives instant access to digital TV programme list.
- ⑬ **CH+/-**  
Switches to the previous or next channel.
- ⑭ **INFO**  
Enables you to view programme information.
- ⑮ **OPTIONS**  
Accesses options for the current activity or selection.
- ⑯ **FORMAT**  
Enables you to browse picture scale.
- ⑰ **MENU**  
Displays menus.

### Warning

Keep the remote control away from any magnetic objects.

## Use the remote control

When using the remote control, point it at the sensor; and then press the desired button. Ensure the line of sight between the remote control and the TV is not blocked by furniture, wall or other objects.

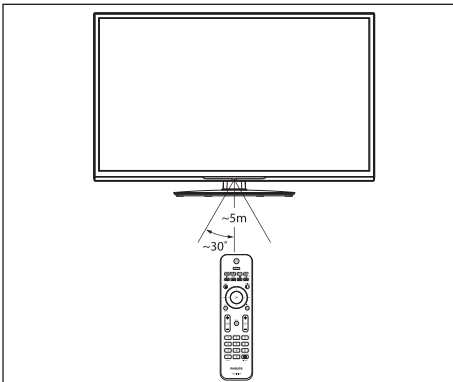



## 4 Use your TV

This section gives instructions on basic TV operations.

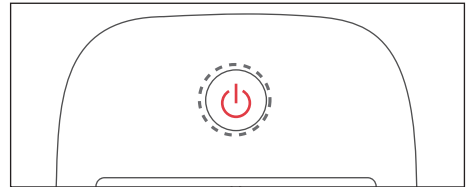
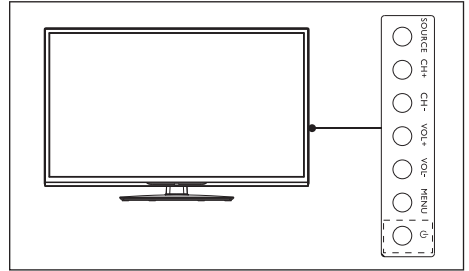
## Turn the TV on/off/to standby



### Turn on your TV

- plug the TV power cord into the power outlet.
- press  (Standby - Power on) on the remote control or  on the side of the TV.

### Switch to standby

- Press  (Standby/Power on) on the remote control.

### Turn off your TV

- Switch your TV to standby; then disconnect the power cord.





### Tip

- Minimal power is still consumed when the TV is in standby. If your TV will be idle for a long period of time, disconnect the TV power plug from the power outlet.

## Switch channels

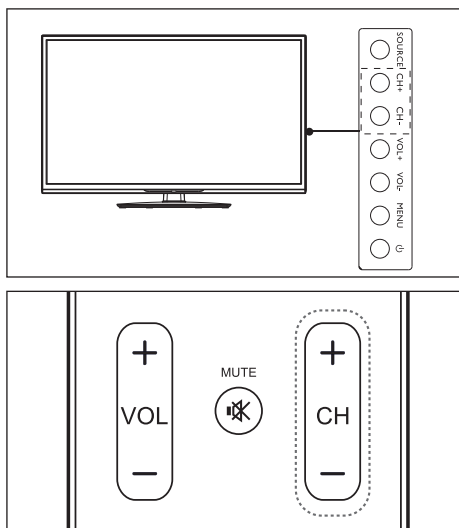

- Press **CH +/-** on the side of the TV or on the remote control.
- Enter a channel number using the **Numeric buttons** on the remote control.
- Press **↶ (BACK)** on the remote control to the previously-viewed channel.

## Watch a connected device



### Note

- Switch on the device before selecting it as an external signal source.

## Use SOURCE button

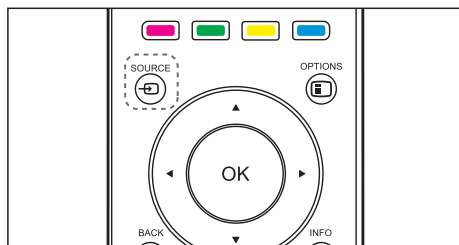



- 1 Press **↶ SOURCE**.  
↳ The source list appears.
- 2 Press **▲▼** to select a source.
- 3 Press **OK** to confirm the selection.  
↳ Switch your TV to the selected source.

---

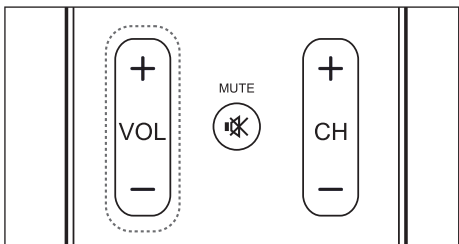
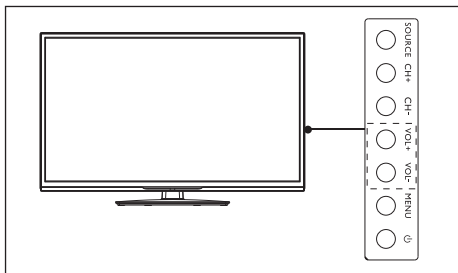
## Adjust TV volume



### To increase or decrease volume

- Press **VOL+/-** on the TV or remote control to adjust volume.
- Press  to mute the sound.
- Press  again to restore the sound.

---

## 5 More functions

---

### Access TV menus

Menus help you to set channels, change picture and sound settings and access other functions.

- 1 Press **MENU**.  
↳ The menu screen appears.

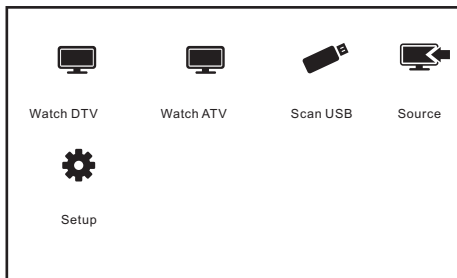

- 2 Press **OK** after selecting one of the following options:
  - **[Watch DTV]**: When other source is selected, choose this setting to switch to digital TV channels.
  - **[ Watch ATV ]**: When other source is select, choose this setting to switch to analog TV channels.
  - **[Scan USB]**: You can view photos or play music and videos on TV from a USB storage device.
  - **[Source]**: Opens the source menu.
  - **[Setup]**: Changes picture, sound and other settings.

---

### Change language

You can select to change the menu language.

---

#### Change menu language

- 1 Press  **Setup**
- 2 Select **[Option]** > **[OSD language]**; then press **▶** to enter.
- 3 Select your desired language.

---

## Change picture and sound settings

Change picture and sound settings to suit your preferences. You can apply pre-defined settings or change settings manually.

---

### Use smart picture

Use smart picture to apply pre-defined picture settings.

- 1 Press  **Setup** ; select **[Picture]** > **[Smart picture]**.
- 2 Select one of the following settings, and then press **OK**:
  - **[Vivid]**: Enhances picture contrast and sharpness.
  - **[Standard]**: Adjusts picture settings to suit most environments and types of video.
  - **[Soft ]**: Adjusts picture softness.
  - **[Personal]**: Users can customize the settings here.

---

### Manually adjust picture settings

- 1 Press  **Setup**.
- 2 Select **[Picture]**; then press **▶** to enter.
- 3 After selecting **[Picture]**, select one of the following settings, and then press **▶** to enter:
  - **[Smart picture]**: Accesses pre-defined settings.
  - **[Contrast]**: Adjusts backlight; increases backlight intensity difference between bright and dark areas (0~100).
  - **[Brightness]**: Adjusts the intensity

and details of darker areas (0~100).

- **[Saturation]**: Adjusts color saturation (0~100).
- **[Sharpness]**: Adjusts sharpness in the image (0~100).
- **[Picture Format]**: Adjusts display scale of picture.
- **[Color Temperature]**: Adjusts overall color temperature of picture.
- **[Noise Reduction]**: Filters and reduces noise from the image signals.

---

### Change picture format

- 1 Press the button for instant access to picture format (**FORMAT**).
- 2 Press **▲▼** to select a picture; then press **OK**.

---

### Summary of picture formats

The following picture settings can be configured.



Note

- Depending on the format of the picture source, some picture settings are not available.

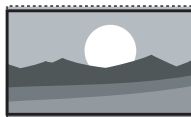

**[Wide screen]**: Adjusts the classic standard format to widescreen.

---



**[4:3]**: Shows the classic 4:3 format.

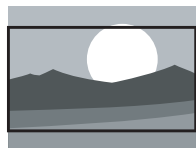

**[Movie 16:9 ]**: Scales the picture format to 16:9.

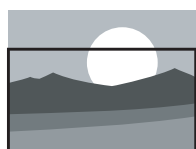

**[Subtitle zoom]**: Displays 4:3 pictures over the full area of the screen, with subtitles visible. Part of the top of the picture is clipped off.

## Use smart sound

Use smart sound to apply pre-defined sound settings.

- 1 Press **Setup**; select **[Sound]** > **[Smart sound]**.
- 2 Select one of the following settings, and then press **OK**.
  - **[Standard]**: Applies to settings for most environments and types.
  - **[Music]**: Applies to sound settings for music.
  - **[Movie]**: Applies to sound settings for movies.
  - **[Personal]**: Uses the settings that were customized in the sound menu.

## Manually adjust sound settings

- 1 Press **Setup**.
- 2 Select **[Sound]**; then press **▶** to enter.
- 3 After selecting **[Sound]**, select one of the following settings, and then press **▶** to enter.

- **[Smart sound]**: Accesses pre-defined smart sound settings.
- **[Treble]**: Adjusts the treble level (0~100).
- **[Bass]**: Adjusts the bass level (0~100).
- **[Balance]**: Adjusts the balance of the right and left speakers.
- **[Auto Volume Levelling ]**: Reduces abrupt volume change when switching channels.
- **[Virtual surround]**: Turns on or off virtual surround sound.

## Change other settings

- 1 Press **Setup**.
- 2 After selecting **[Option]**, select one of the following settings, and then press **▶** to enter.
  - **[OSD language ]**: Changes the menu language.
  - **[OSD duration ]**: Sets the display period of system menu: 15/30/45/60 sec.
  - **[ OSD transparency ]**: Changes the level of transparency for menu display (0~100).
  - **[Blue screen]**: Enables or disables blue screen display.
  - **[Sleep timer]**: Sets the sleep time (0~180 min).
  - **[ Eco]**: Enables or disables Smart Eco.
  - **[Backlight]**: Sets the level of backlight (0~100).  
(The functions of Smart Eco and Backlight are subject to the actual model)

- **[Reset all ]:** Restores picture and sound settings to factory default.

---

## Use timers

You can set timers to switch the TV to standby at a specified time.

---

### Automatically switch the TV to standby (sleep timer)

Sleep timer switches the TV to standby after a pre-defined period of time.



Tip

- You can switch off your TV earlier or reset the sleep timer during the countdown.

- 1 Press  **Setup**.
- 2 Select **[Option]** > **[Sleep timer]**.  
↳ The sleep timer appears.
- 3 Select a preset time from 0-180 min.  
↳ The sleep timer can be set in steps of ten minutes. If set to 0, the sleep timer is switched off.

---

## Use TV locks

You can prevent your children from watching certain programme or channels by locking the TV controls.

---

### Set or change your code

- 1 Press  **Setup**.
- 2 Select **[Child lock]** > **[Change code]**.
- 3 Enter your code using the **Numeric buttons**.

↳ Follow the on-screen instructions to set or change your code.



Tip

- If you forget your code, enter 3448 in **[Change code]** to override any existing codes.
- When **[Change code]** is used to set a new code, this code may be needed for some settings.

---

### Lock or unlock one or more channels

- 1 Press  **Setup**.
- 2 Select **[Child lock]** > **[channel Lock]**; then enter your code.  
↳ The channel list appears.
- 3 Select a channel to be locked or unlocked, and press the color button (green).  
↳ If you access a locked channel for the first time, you will be prompted to enter your code.



Note

- The function of Child lock is available only in TV mode.

---

## USB functions

Supported video formats on the USB:

- Supported storage device: USB (only FAT or FAT 32 USB storage devices are supported.)
- Supported multimedia file formats:
  - Image: JPEG
  - Audio: MP3
  - Video: MPEG2/MPEG4, H.264



### Caution

Philips is not responsible if the USB storage device is not supported nor is it responsible for damage or loss of data from the device.

---

## View photos and play music and videos from a USB storage device connected

- 1 Turn on the TV.
- 2 Connect the USB storage device to the USB port on the side of the TV.
- 3 Press **SOURCE** on the remote control.
- 4 Select your USB device connected; press **OK**.
  - ↳ The USB content browser appears.

---

## View photos

- 1 In the USB browser, select **[Picture]**; then press **OK**.
- 2 Select a photo or a photo album; then press **OK**. The selected photo will be enlarged to fit the full screen and played automatically.

---

## View a slide show of your photos

- 1 When a full screen image of a photo is displayed, press **OK**.
  - ↳ A slide show begins from the selected photo.
- 2 Press the following buttons to control the slide show:
  - **▶▶ /OK**: Play or Pause
  - **Color buttons (Red/Blue)**: View the previous or next photo.
  - Press **BACK** to stop the slide show.

---

## Change slide show settings

- 1 When viewing a slide show, press **☰** **OPTIONS**.
- 2 Press **OK** after selecting one of the following settings:
  - **[Play/Stop]**: Stops or starts a slide show.
  - **[Trans effect]**: Sets the special effects during the change of photos.
  - **[Frequency]**: Sets the amount of time that a photo is shown.
  - **[Repeat/Play once]**: Displays a slide once or repeatedly.
  - **[Random play on/off]**: Displays the slides in sequence or randomly.
  - **[Rotate]**: Rotates a photo.

- **[Capture]:** Sets a photo to be the startup picture or restores the startup picture.
- **[Show info]:** Displays file information.

---

## Listen to music

- 1 From the USB content browser, select **[Music]** and press **OK**.
- 2 Select a music track or album and press **OK** to play.
- 3 Press the following buttons to control music playback:
  - **⏮/OK:** Play or Pause.
  - **⏪/⏩:** Find previous or find next.
  - **Color buttons (Red/Blue):** Listen to the previous or next music.

---

## Change music settings

To play music, press **⏻** **OPTIONS**, select one of the following settings and press **OK**.

- **[play/stop]:** Stops or starts playing the music.
- **[Repeat/Play once]:** Plays the music once or repeatedly.
- **[Randomplay on/off]:** Plays the music in sequence or randomly.
- **[Show info]:** Displays file information.

---

## View a slideshow with music

You can view a photo slide show with background music.

- 1 Select a music album.
- 2 Press **OK**.
- 3 Press **BACK** to return to the USB content browser.
- 4 Select a photo album.
- 5 Press **OK** to start a slide show.

---

## Watch videos

- 1 From the USB content browser, select **[Video]** and press **OK**.
- 2 Select a video, and press **OK** to play the video.
- 3 Press the following buttons to control video playback:
  - **⏮/OK:** Play or Pause.
  - **⏪/⏩:** Find previous or find next.
  - **Color buttons (Red/Blue):** Watch the previous or next video.

---

## Change video settings

To play music, press **⏻** **OPTIONS**, select one of the following settings and press **OK**.

- **[play/stop]:** Stops or starts playing a video.
- **[Repeat/Play once]:** Plays a video once or repeatedly.
- **[Randomplay on/off]:** Plays the videos in sequence or randomly.
- **[Show info]:** Displays file information.

---

## Disconnect a USB storage device



### Caution

- Follow this procedure to avoid damage to your USB storage device.

- Press **↶ BACK/CH +/-** to exit the USB content browser.
- Wait for five seconds; then disconnect the USB storage device.

## 6 Install channels

This section provides instructions on how to re-install and fine-tune channels.

---

### Automatically search channels

---

#### Step 1 Select menu language

- Press **⚙ Setup**.
- Select **[Option] > [OSD language]**; then press **▶** to enter.
- Select a language.

---

#### Step 2 Automatically search channels

- Press **⚙ Setup**.
- Select **[Channel] > [Auto search]**; then press **▶** to enter.
- Press **OK** to start searching channels automatically.



### Note

- You can press the **BACK (↶)** button to stop searching. During automatic search, ATV channels are first searched, then DTV channels.

---

## ATV manual tuning

Confirm that the input source is analog TV before search.

---

#### Step 1 Select your system



### Note

- Skip this step if your system settings are correct.
- Press **⚙ Setup**.
  - Select **[Channel]**.
  - Select your **[Color system]** and **[Sound system]**.

---

#### Step 2 Search and store new channels

- Press **⚙ Setup**.
- Select **[Channel] > [Manual search]**.
  - Select **[Channel]**; press **▲▼** to select a channel number.
  - Select **[Search]**; press **▲▼** to start searching.
- After searching:
  - Select **[Finished]** to store the searched channel as the current channel.

---

#### Step 3 Fine-tune channels

- Press **⚙ Setup**.
- Select **[Channel] > [Fine tune]**.
- Press **▲▼** to adjust channel frequency.
- Select **[Finished]** to exit fine tune.

---

## DTV manual tuning

Confirm that the input source is digital TV before search.

- Press **⚙ Setup**.
- Select **[Channel] > [Manual search]**.



- 3 Press ◀▶ to select channels; press OK to start searching.

---

## DTV programme guide

The programme guide is available on digital TV.

- 1 Press the **Electronic Programme Guide (EPG)** button to open the programme guide list.
- 2 Press ▲▼ to select time and channels.
- 3 Press corresponding color buttons to view information/ scheduled list/ scheduled programme.



### Note

- Programme information is provided by Broadcasting Company; the programme entry may be empty or cannot show date. When new information is available, the on-screen display will be updated automatically.
- The start time of a scheduled programme must be later than the current time; or else, the schedule is invalid.

---

## Edit channels

- 1 Press ⚙ **Setup**.
- 2 Select **[Channel]** > **[Channel edit]**.
- 3 Press ▲▼ to select channels; press color buttons to delete/move/FAV/skip channels.

---

## software Upgrade

Upgrade software via USB.

# 7 Connect devices

This section describes how to connect various devices with different connectors.



### Note

- You can use different types of connectors to connect a device to your TV. The connection method in this section is for illustration only, which is basically the same as the connection method for other devices. The specific connector position is subject to the actual model.

---

## Back connectors

### ① Component input/Video 2 input (Video 2/Y, Pb, Pr, Audio-L/R)

Analog audio and video input from devices such as DVD players and game consoles.

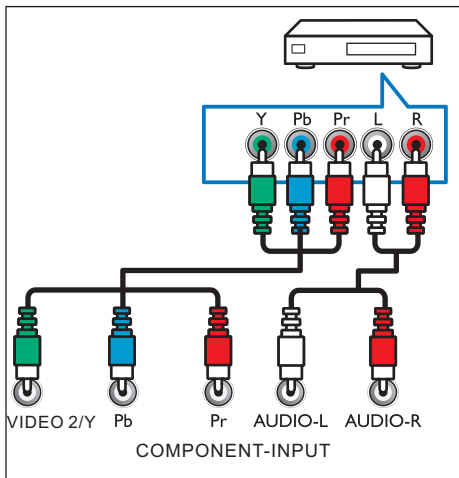

Note

Video 2 and component Y signals of your TV share an input connector; Video 2 audio and component audio share an input connector.

② Coaxial

- **Coaxial:** Connect to digital audio output from home theater systems and other digital audio systems.

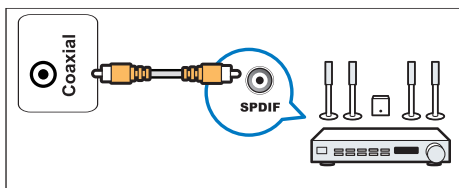

③ Video input

Composite video input from analog devices such as VCR.

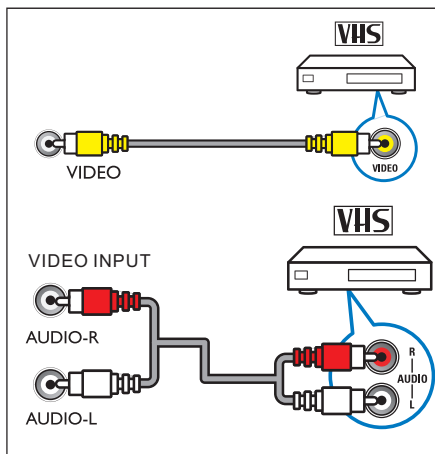

④ Video output

Connect devices with audio/video input connectors (such as monitor).

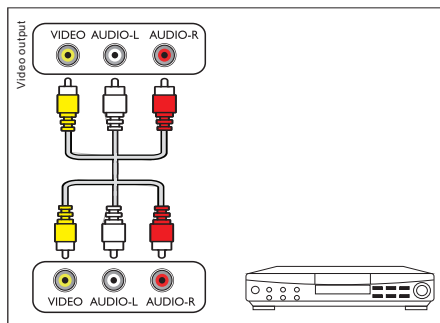

---

## Side connectors

### ① Antenna / Cable TV

Signal input from an antenna, cable or satellite.

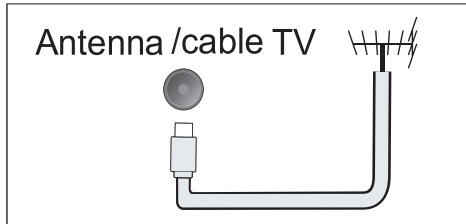

#### Note

- In order to prevent possible hazards such as fire, the cable network antenna connect to your TV must be isolated from the protective earthing.

### ② Audio and video input from a PC

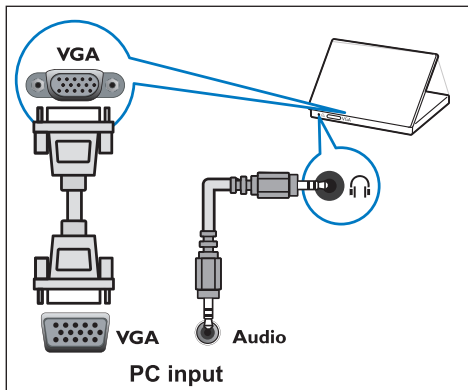

### ③ HDMI

Digital audio and video input from high-definition digital devices such as Blu-ray players.

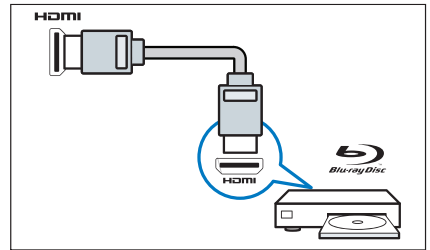

### ④ USB

Data input from USB storage devices.

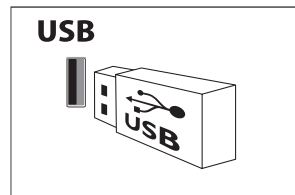

### ⑤ Headphone

Stereo audio output to headphones.

#### Note

- When a headphone is plugged in, the TV speakers will be automatically muted.

---

## Connect a PC

Before you connect a PC to the TV

- Select a supported screen resolution on your PC.

Connect a computer with one of the following connectors:

#### Note

- Connections via DVI or VGA require an additional audio cable.

- HDMI cable

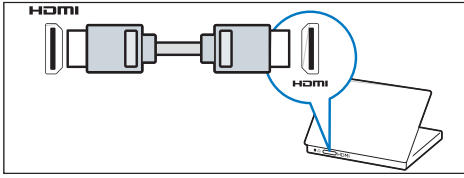

- DVI-HDMI cable

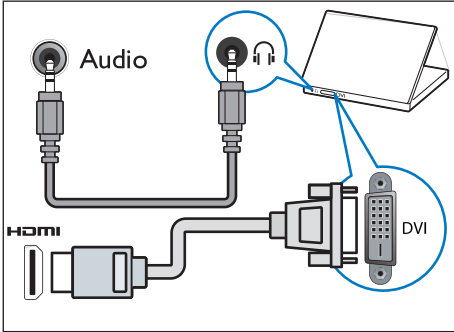

- HDMI cable and HDMI-DVI adapter

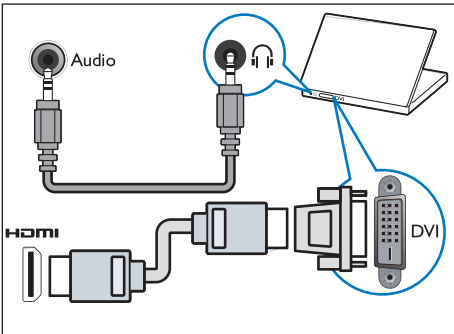

- VGA cable

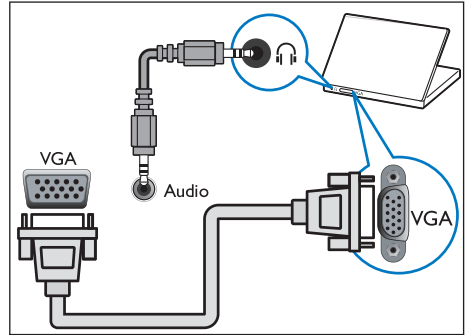

## Use Philips EasyLink

Maximizing the use of your Philips EasyLink HDMI-CEC-compliant device can enhance its control functions to the maximum level of efficiency. HDMI-CEC-compliant devices that are connected through HDMI connectors can be controlled by the TV's remote control. To enable Philips EasyLink, you will need to:

- connect two or more HDMI-CEC-compliant devices through the HDMI connectors;
- confirm that each HDMI-CEC-compliant device is functioning properly;
- switch to EasyLink.



### Note

- The EasyLink-compliant device must be switched on and selected as the source.
- Philips does not guarantee 100% interoperability with all HDMI CEC devices.

---

## Enable or disable EasyLink

After enabling the HDMI-CEC-compliant device, the TV will automatically turn on and switch to the correct source.



### Note

- Do not enable Philips EasyLink if you do not intend to use it.

- 1 Press **MENU**.
- 2 Select **[Setup]** > **[EasyLink]** > **[Easylink]**.
- 3 Select **[Off]** or **[On]**; then press **OK**.

## 8 Product information

Product information is subject to change without notice. For detailed product information, please visit [www.philips.com/support](http://www.philips.com/support).

---

## Supported display resolutions

### PC formats

- Resolution - refresh rate:
    - 720×400 70Hz
    - 640×480 60Hz
    - 800×600 60Hz
    - 1024×768 60Hz
    - 1360×768 60Hz
- (32")

- 720×400 70Hz
- 640×480 60Hz
- 800×600 60Hz
- 1024×768 60Hz
- 1360×768 60Hz
- 1600×900 60Hz
- 1920×1080 60Hz

(42")

### Video formats

- Resolution - refresh rate:
  - 480i - 60Hz
  - 480p - 60Hz
  - 576i - 50Hz
  - 576p - 50Hz
  - 720p - 50Hz, 60Hz
  - 1080i - 50Hz, 60Hz
  - 1080p - 50Hz, 60Hz

---

## Tuner/Reception/ Transmission

- **Antenna input:** 75ohm coaxial (IEC75)
- **TV system:** ATV: PAL+NTSC;  
DTV:DTMB
- **Video playback:** NTSC, PAL

---

## Remote control

- Batteries: 2 × AAA (Type LR03)

---

## Power

- Main power : 220~, 50Hz
- Standby power: ≤0.5 W
- Ambient temperature: 5~40°C
- 32" power consumption: 55W
- 42" power consumption: 98W

---

## Supported TV mounts

To mount the TV, please purchase a Philips TV mount or any TV mount compliant with the VESA standard. To prevent damage to cables and connectors, be sure to leave a clearance of at least 2.2 inches or 5.5cm from the back of the TV.



### Warning

- Follow all instructions provided with the TV mount. Koninklijke Philips N.V. bears no responsibility for any accident, injury or damage caused by improper TV mounting.

TV screen size (inches)	Required pitch (mm)	Required mounting screws
32"	100×100	4×M4
42"	300×200	4×M6

---

## Product specification

For product updating, design and specifications are subject to change with notice.

### 32"

- Without TV stand
  - Dimension (W×H×D): 740×451×69 (mm)
  - Weight: 6.6kg
- With TV stand
  - Dimension (W×H×D): 740×495×220 (mm)
  - Weight: 7.0kg

### 42"

- Without TV stand
  - Dimension (W×H×D): 973×583×72 (mm)
  - Weight: 11.0kg
- With TV stand
  - Dimension (W×H×D): 973×635×239 (mm)
  - Weight: 13.5kg

# 9 Troubleshooting

This section introduces the common problems and their corresponding solutions.

---

## General

The TV does not switch on:

- Disconnect the power cord from the power outlet. Wait for one minute, and then reconnect it.
- Check that the power cord is securely connected.

The remote control works abnormally:

- Check that the remote control batteries are properly installed with +/- terminals in right positions.
- Replace the remote control batteries in case of battery exhaustion or leakage.
- Clean the remote control and the TV sensor lens.

The standby light on the TV blinks:

- Disconnect the power cord from the power outlet. Wait until the TV cools down before reconnecting the power cord. If the blinking reoccurs, contact Philips Consumer Care.

You forgot the code to unlock the child lock feature:

- Select [Child lock] > [Change code]; enter 3448 to override any existing code.

The TV menu is in the wrong language:

- Change the TV menu to your preferred language.

When turning the TV on/off/to standby,

you hear a creaking sound from the TV chassis:

- No action is required. The creaking sound is normal expansion and contraction of the TV as it cools and warms up. This does not impact its performance.
- 

## Picture

The TV is on, but there is no picture:

- Check that the antenna is properly connected to the TV.
- Check that the correct device is selected as the TV source.

There is sound but no picture:

- Check that the picture settings are correct.

There is poor TV reception from an antenna connection:

- Check that the antenna is properly connected to the TV.
- Loud speakers, unearthed audio devices, neon lights, high buildings and other large objects can influence reception quality. If possible, try to improve the reception quality by changing the antenna direction or moving devices away from the TV.
- If reception on only one channel is poor, fine tune this channel.

There is poor picture quality from connected devices:

- Check that the devices are connected properly.
- Check that the picture settings are correct.

The TV did not save your picture settings:

- Check that the TV location is set to the home setting. This mode offers you the flexibility to change and save settings.

The picture does not fit the screen; it is too big or too small:

- Try using a different picture format.

The picture position is incorrect:

- Picture signals from some devices may not fit the screen correctly. Check the signal output of the device.

---

## Sound

There is picture but sound quality is poor:



Note

If no audio signal is detected, the TV automatically switches the audio output off this does not indicate malfunction.

- Check that all cables are properly connected.
- Check that the volume is not set to 0.
- Check that the sound is not muted.

There is picture but sound quality is poor:

- Check that the sound settings are correct.

There is picture but sound comes from one speaker only:

- Verify that sound balance is set to the centre.

---

## HDMI connection

There are problems with HDMI devices:

- Note that HDCP (High-bandwidth Digital Content Protection) support can delay the time taken for a TV to display content from a HDMI device.

- If the TV does not recognize the HDMI device and no picture is displayed, try switching the source from one device to another and back again.
- If there are intermittent sound disruptions, check that output settings from the HDMI device are correct.
- If you use an HDMI-to-DVI adapter or HDMI to DVI cable, check that an additional audio cable is connected to AUDIO (mini-jack only).

---

## Computer connection

The computer display on the TV is not stable:

- Check that your PC uses the supported resolution and refresh rate.
- Set the TV picture format to unscaled.

---

## Contact us

If the problem remains unresolved, contact the local Philips Consumer Care.



Warning

- Do not attempt to repair the TV yourself. This may cause severe injury or irreparable damage to your TV or void your warranty.



Note

- Make a note of your TV model and serial number before you contact Philips. These numbers are printed on the back of the TV and on the packaging.



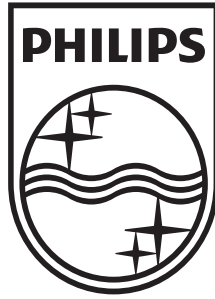

All registered and unregistered trademarks are the property of their respective owners. Specifications are subject to change without notice.

Philips and the Philips' shield emblem are registered trademarks of Koninklijke Philips Electronics N.V. and are used under license from Koninklijke Philips Electronics N.V.

2013© TP Vision Netherlands B.V. All rights reserved.