

Register your product and get support at

www.philips.com/welcome

32PHA4509

40PFA4509

50PFA4509

EN User manual

PHILIPS

Contents

1	Caution	2
2	Important	3
	Safety	3
3	Your TV	5
	Control Panel	5
	Remote Control	5
	Remote control usage	6
4	Use your TV	7
	Switch TV on or off	7
	Switch channels	7
	Watch connected devices	8
	Adjust TV volume	8
5	Other uses of the TV	9
	Accessing the TV menu	9
	Change the picture and sound setup	9
	Adjusting setup	10
	Use timer	12
	Adjusting VGA Setup	12
	Playing media from USB devices	13
	Updating the TV software	15
	Restoring the factory setup	15
6	Setting up channels	16
	Setting up channels automatically	16
	Updating channels	16
	Setting channels manually	16
	Renaming channels	17

7	TV connections	18
	Rearconnections	18
	Side connections	18
	Connecting to a computer	20
	Use Philips EasyLink	21
8	Product information	22
	Display resolutions	22
	Multimedia	22
	Sound power	22
	Inherent resolution	22
	Tuner / Reception / Transmission	22
	Remote Control	22
	Power Supply	22
	Supported TV mounts	23
9	Troubleshooting	24
	General issues	24
	Channel issues	24
	Picture issues	24
	Sound issues	25
	HDMI connection issues	25
	Computer connection issues	25
	Contact us	25

1 Caution

2014©TP Vision Europe B.V. All rights reserved. Specifications are subject to change without notice. Trademarks are the property of Koninklijke Philips N.V. or their respective owners. TP Vision Europe B.V. reserves the right to change products at any time without being obliged to adjust earlier supplies accordingly. The material in this manual is believed adequate for the intended use of the system. If the product, or its individual modules or procedures, are used for purposes other than those specified herein, confirmation of their validity and suitability must be obtained. TP Vision Europe B.V. warrants that the material itself does not infringe any United States patents. No further warranty is expressed or implied. TP Vision Europe B.V. cannot be held responsible neither for any errors in the content of this document nor for any problems as a result of the content in this document. Errors reported to Philips will be adapted and published on the Philips support website as soon as possible.

Terms of warranty

- Risk of injury, damage to TV or void of warranty! Do not attempt to repair the TV yourself.
- Use the TV and accessories only as intended by the manufacturer.
- The caution sign printed on the back of the TV indicates risk of electric shock. Never remove the TV cover. Always contact Philips Customer Support for service or repairs.



- Any operation expressly prohibited in this manual, or any adjustments and

assembly procedures not recommended or authorised in this manual shall void the warranty.

Pixel characteristics

This LCD/LED product has a high number of color pixels. Although it has effective pixels of 99.999% or more, black dots or bright points of light (red, green or blue) may appear constantly on the screen. This is a structural property of the display (within common industry standards) and is not a malfunction.

Mains fuse (/56)

This TV is fitted with an approved moulded plug. Should it become necessary to replace the mains fuse, this must be replaced with a fuse of the same value as indicated on the plug (example 10A).

- 1 Remove fuse cover and fuse.
- 2 The replacement fuse must comply with BS 1362 and have the ASTA approval mark. If the fuse is lost, contact your dealer in order to verify the correct type.
- 3 Refit the fuse cover.

Copyright



®Kensington and Micro Saver are registered US trademarks of ACCO World corporation with issued registrations and pending applications in other countries throughout the world.



HDMI, the HDMI logo and High-Definition Multimedia Interface are trademarks or registered trademarks of HDMI licensing LLC in the United States and other countries. All other registered and unregistered trademarks are the property of their respective owners.

2 Important

Read and understand all instructions before you use your TV. If damage is caused by failure to follow instructions, the warranty does not apply.

Safety

Risk of electric shock or fire!

- Never expose the TV to rain or water. Never place liquid containers, such as vases, near the TV. If liquids are spilt on or into the TV, disconnect the TV from the power outlet immediately. Contact Philips Consumer Care to have the TV checked before use.
- Never place the TV, remote control or batteries near naked flames or other heat sources, including direct sunlight. To prevent the spread of fire, keep candles or other flames away from the TV, remote control and batteries at all times.



- Never insert objects into the ventilation slots or other openings on the TV.
- When the TV is swivelled ensure that no strain is exerted on the power cord. Strain on the power cord can loosen connections and cause arcing.
- To disconnect the TV from the mains power, the power plug of the TV must be disconnected. When disconnecting the power, always pull the power plug, never the cord. Ensure that you have full access to the power plug, power cord and outlet socket at all times.

Risk of short circuit or fire!

- Never expose the remote control or batteries to rain, water or excessive heat.

- Avoid force coming onto power plugs. Loose power plugs can cause arcing or fire.

Risk of injury or damage to the TV!

- Two people are required to lift and carry a TV that weighs more than 25 kg or 55 lbs.
- When stand mounting the TV, use only the supplied stand. Secure the stand to the TV tightly. Place the TV on a flat, level surface that can support the combined weight of the TV and the stand.
- When wall mounting the TV, use only a wall mount that can support the weight of the TV. Secure the wall mount to a wall that can support the combined weight of the TV and wall mount. TP Vision Europe B.V. bears no responsibility for improper wall mounting that results in accident, injury or damage.
- If you need to store the TV, disassemble the stand from the TV. Never lay the TV on its back with the stand installed.
- Before you connect the TV to the power outlet, ensure that the power voltage matches the value printed on the back of the TV. Never connect the TV to the power outlet if the voltage is different.
- Parts of this product may be made of glass. Handle with care to avoid injury and damage.

Risk of injury to children!

Follow these precautions to prevent the TV from toppling over and causing injury to children:

- Never place the TV on a surface covered by a cloth or other material that can be pulled away.
- Ensure that no part of the TV hangs over the edge of the surface.
- Never place the TV on tall furniture (such as a bookcase) without anchoring both the furniture and TV to the wall or a suitable support.
- Educate children about the dangers of climbing on furniture to reach the TV.

Risk of swallowing batteries!

- The product/remote control may contain a coin-type battery, which can be swallowed. Keep the battery out of reach of children at all times!

Risk of overheating!

- Never install the TV in a confined space. Always leave a space of at least 4 inches or 10 cm around the TV for ventilation. Ensure curtains or other objects never cover the ventilation slots on the TV.

Risk of injury, fire or power cord damage!

- Never place the TV or any objects on the power cord.
- Disconnect the TV from the power outlet and antenna before lightning storms. During lightning storms, never touch any part of the TV, power cord or antenna cable.

Risk of hearing damage!

- Avoid using earphones or headphones at high volumes or for prolonged periods of time.

Low temperatures

- If the TV is transported in temperatures below 5°C or 41°F, unpack the TV and wait until the TV temperature matches the room temperature before connecting the TV to the power outlet.

Screen care

- Avoid stationary images as much as possible. Stationary images are images that remain on-screen for extended periods of time. Example: on-screen menus, black bars and time displays. If you must use stationary images, reduce screen contrast and brightness to avoid screen damage.
- Unplug the TV before cleaning.
- Clean the TV and frame with a soft, damp cloth. Never use substances such as alcohol, chemicals or household cleaners on the TV.

- Risk of damage to the TV screen! Never touch, push, rub or strike the screen with any object.
- To avoid deformations and color fading, wipe off water drops as soon as possible.

Recycling



Your product is designed and manufactured with high quality materials and components, which can be recycled and reused.



When this crossed-out wheeled bin symbol is attached to a product it means that the product is covered by the European Directive 2002/96/EC. Please inform yourself about the local separate collection system for electrical and electronic products.

Please act according to your local rules and do not dispose of your old products with your normal household waste.

Correct disposal of your old product helps to prevent potential negative consequences for the environment and human health.



Your product contains batteries covered by the European Directive 2006/66/EC, which cannot be disposed of with normal household waste. Please inform yourself about the local rules on separate collection of batteries because correct disposal helps to prevent negative consequences for the environment and human health.

3 Your TV

Congratulations on your purchase, and welcome to Philips! To fully benefit from the support that Philips offers, register your TV at www.philips.com/welcome.

Control Panel

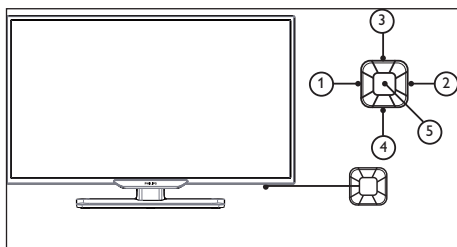

- ① **Volume-**: When there is no keyboard menu, lower the volume function; When the keyboard menu appears, move the appropriate options to the left / right.
- ② **Volume+**: When there is no keyboard menu, improve the volume function; when the keyboard menu appears, move the appropriate options to the left / right.
- ③ **Channel+**: When there is no keyboard menu, switch to the next channel function; when the keyboard menu appears, move up and down the appropriate options.
- ④ **Channel-**: When there is no keyboard menu, switch to the prior channel function; when the keyboard menu appears, move up and down the appropriate options.
- ⑤ **Signal source/OK**: In standby status, the signal source / OK key is used as a power key, press this key to boot. After booting, the menu signal source / OK is used to open the keyboard menu functions. When the keyboard menu is open, the signal source / OK is used as a confirm key.
Note: The control panel on the smart TV and the web browser has no effect, the source / OK key under USB has no effect.

Remote Control

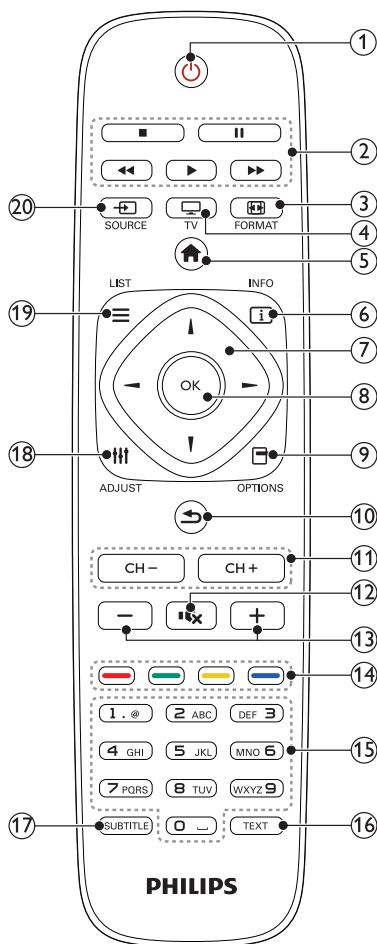

- ① **⏻ (Standby)**
Switch the TV on or to standby.
- ② **Play buttons**
Control video or music.
- ③ **TV FORMAT**
Change picture format.
- ④ **TV**
Switch source to watch TV.

- 5 **🏠 (Home)**
Access the home menu.
- 6 **ℹ️ INFO**
Display information about current activity.
- 7 **▲▼◀▶ (Navigation buttons)**
Navigate through menus and select items.
- 8 **OK**
Confirm an entry or selection.
- 9 **⚙️ OPTIONS**
Access options for the current activity or selection.
- 10 **↶ (Back)**
Return to the previous menu or exit a function.
- 11 **CH +/- (Channel +/-)**
Switch channels.
- 12 **🔇 (Mute)**
Mute or restore audio.
- 13 **+/- (Volume)**
Adjust volume.
- 14 **Color buttons**
Select tasks or options.
- 15 **0-9 (Numeric buttons)**
Select channel.
- 16 **TEXT**
Enable or disable teletext.
- 17 **SUBTITLE**
Enable or disable subtitles.
- 18 **⚙️ ADJUST**
Access the setup menu.
- 19 **☰ LIST**
Access the TV channel list.
- 20 **📺 SOURCE**
Select connected devices.

Remote control usage

When you use the remote control, hold it close to the TV and point it at the remote control sensor. Make sure that the line-of-sight between the remote control and TV is not blocked by furniture, walls or other objects.

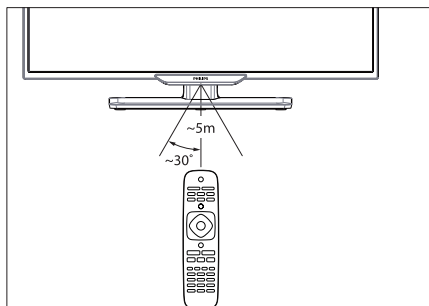

4 Use your TV

This section helps you perform basic TV operations.

Switch TV on or off

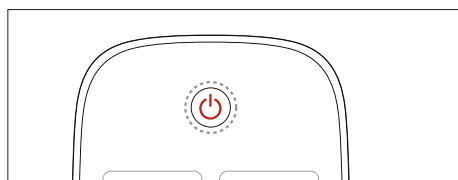
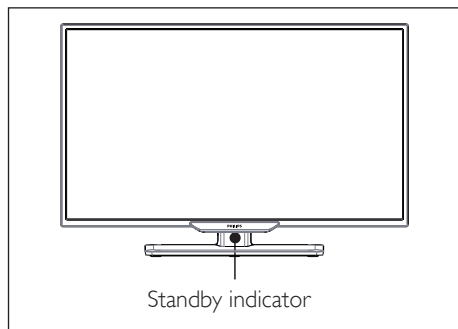

To switch on

- Plug in the power plug.
 - ↳ If the standby indicator is red, press  (Standby-On) on the remote control.

To switch to standby

- Press  (Standby-On) on the remote control.
 - ↳ The standby indicator switches to red.



Tip

- Though your TV consumes very little power when in standby mode, energy continues to be consumed. When not in use for an extended period of time, disconnect the TV power cable from the power outlet.

Switch channels

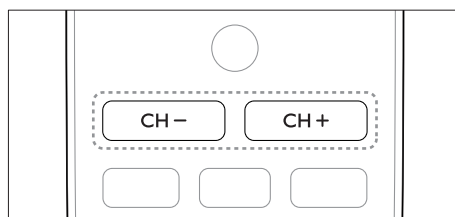
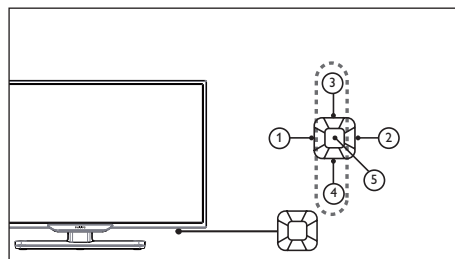



- Press **CH +/-** on the remote control or the lower right part of the TV.
- Enter a channel number using the numeric buttons on the remote control.
- Press  on the remote control to switch and return to the previous channel.

View installed channel

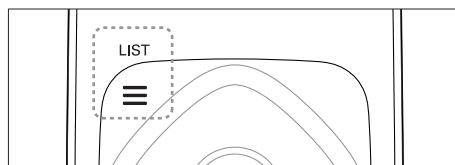
You can view all available channels on the channel list.



- 1 Press **OK** or  **LIST**.
 - ↳ The channel list appears.
- 2 Press **▲▼** to select a channel and browse the channel list.
- 3 Press **OK** to watch the selected channel.
- 4 Press  to switch to and resume the last watched channel.

Watch connected devices

Note

- Switch on the device before selecting it as an external signal source.

Use the Source button

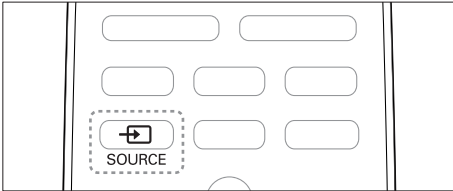

- 1 Press **SOURCE**.
↳ The source list appears.
- 2 Press **▲▼** to select a device.
- 3 Press **OK** to select.
↳ The TV switches to the selected device.

Adjust TV volume

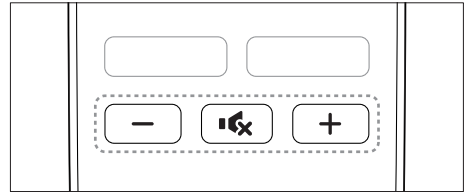
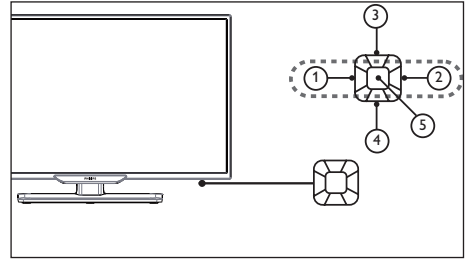

To increase or decrease volume

- Press **VOL +/-** at the lower right part of the TV or the **Volume Control +/-** on the remote control.

To mute or unmute sound

- Press **Mute**.
- Press **Mute** again to restore the sound.

5 Other uses of the TV

Accessing the TV menu

The menu can help you to set up channels, change the picture and sound setup, and access other functions.

- 1 Press **Home** .
↳ Display menu screen.

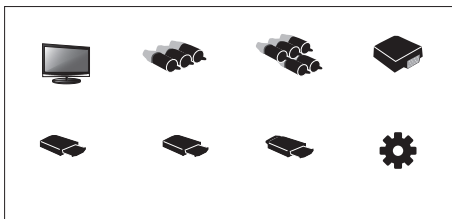

- 2 Select **[Setup]**.
- 3 Press **▲▼◀▶** Choose from the following options:
 - **[Picture]** / **[Sound]** / **[TV]** (Can only be used in TV mode) / **[Setup]** / **[Parental]** / **[VGA setting]** (Can only be used in PC mode) / **[EasyLink]**.
- 4 Press **OK** to select.
- 5 Press **Home** to go back.

Change the picture and sound setup

Change the picture and sound setup to suit your preferences. You can either use the presets or manually change the setup.

Adjusting the picture setup

- 1 Press **##ADJUST** and select **[Picture]**.
↳ Displays the **[Picture]** menu.
- 2 Press **▲▼◀▶** Selecting/adjusting setup:
 - **[Smart picture]**:
 - **[Standard]**: Normal picture setup. Recommended for home entertainment use.
 - **[Eco]**: Decreases the intensity of the backlight to reduce power consumption.
 - **[Vivid]**: Increases the contrast and sharpness of the picture.
 - **[Movie]**: Applies setup for watching movies, which works best in a theater environment.
 - **[Personal]**: Users can customize setup here.
 - **[Brightness]**: Adjusts the intensity and detail of dark areas (adjustments made can only be saved in personal setup).
 - **[Video contrast]**: Adjusts the intensity and detail of bright areas, with dark areas remaining unchanged (adjustments made can only be saved in personal setup).
 - **[Color]**: Adjusts the color saturation (adjustments made can only be saved in personal setup).
 - **[Tint]**: Adjusts the level of green (this option only appears when using the NTSC standard).
 - **[Sharpness]**: Adjusts the sharpness of the image (adjustments made can only be saved in personal setup).

- **[Color Temperature]:**
 - **[Cool]:** Bluish white tint.
 - **[Normal]:** White tint. Users can personalize the white tint in PC mode.
 - **[Warm]:** Reddish white tint.
- **[Advanced control]:**
 - **[Noise Reduction]:** Filters and eliminates signal noise within the image.
 - **[Backlight]:** Adjusts the screen brightness (when the backlight brightness is set to a low value, a momentary white flicker may be visible when turning on the unit. This is normal. When **[Dynamic Backlight]** is turned on, this function will be hidden).
 - **[Dynamic Contrast]:** Sets the contrast to maximum. (There are no advanced contrast functions in PC mode.)
 - **[Dynamic Backlight]:** The contrast level will change with the brightness of the image.
- **[Personal]:** Provides user customization functions in order to optimize all sound effect parameters and achieve the best experience.
- **[Balance]:** Adjusts the balance of the left and right speakers.
- **[Bass]:** Adjusts the bass level (adjustments made can only be saved in personal setup).
- **[Treble]:** Adjusts the treble level (adjustments made can only be saved in personal setup).
- **[Virtual surround]:** Turns virtual surround sound on: Turn on or off.
- **[AVL]:** Turns automatic volume adjustment on.

Adjusting the sound setup

1 Press **⏏ ADJUST** and select **[Sound]**.
↳ Displays the **[Sound]** menu.

2 Press **▲▼◀▶** Select and adjust the setup:

- **[Smart Sound]:**
 - **[Standard]:** Gives balanced, outstanding sound performance in the treble, mid and bass ranges.
 - **[Music]:** Enhances treble and bass, delivering bright, clear and pure sound quality when listening to piano or orchestral instrument performances.
 - **[Speech]:** Enhances the performance of sound ranges involved in the voice spectrum. Suitable for watching news or arts programs.

Adjusting setup

1 Press **⏏ ADJUST** and select **[Setup]**.
↳ Displays the **[Setup]** menu.

2 Press **▲▼◀▶** Select and adjust the setup:

- **[Menu language]:** Changes the TV's language setup.
- **[Picture Format]:** The majority of signals use 16:9, 4:3, Zoom 1 and Zoom 2 formats; HDMI signal sources use 16:9, 4:3, Point to Point, zoom 1 and zoom 2 formats; VGA signal sources on PCs use 16:9, 4:3 and Point to Point formats.
- **[Menu Timeout]:** Sets the duration for which the menu is displayed.
- **[Menu Transparency]:** Sets the level of transparency for the menu.
- **[Blue Screen]:** Sets the screen color for when the TV is not receiving a signal (when the TV signal is not functioning).
- **[Auto Sleep]:** Sets the duration the TV may be idle before it automatically switches off.

- **[Sleep Timer]:** Sets the duration the TV remains idle before it automatically enters standby mode. Adjust the time with the sleep button on the remote control. Options: Off/10/20/30/60/90/120/180 minutes. (Does not apply in PC mode).
- **[Power On Status]:** Sets the TV's status when it is connected to an AC power supply.
- **[Time Setup]:** Sets the system time.
- **[Freeze Switch]:** Sets the channel freeze switch mode. (Only displayed in TV mode)
- **[TTX Language]:** Sets the TTX language. (Can only be used in TV mode).
- **[Color System]:** Sets the AV color system. (Only displayed in AV mode)
- **[HDMI]:** Sets the HDMI mode. (Only displayed in 480p/576p/720p/1080p HDMI modes.)
- **[Reset]:** Restores the default setup. (Excluding password setup and channel information)

Changing picture format

- 1 Press **⏏** ADJUST and select **[Setup]**.
- 2 Press **▲▼◀▶** Select **[Picture Format]**.
- 3 Select a picture format.
- 4 Press OK to confirm.

Summary of picture formats

Configuration of the picture setup listed below.

Notes

- Some picture setups may be unavailable due to differences between picture signal formats.



[16:9]: Change the normal ratio to widescreen format.



[4:3]: The normal format.



[Zoom 1]: Horizontal scaling of the widescreen picture format. When this format is used, the two edges of the picture frame will be partly cut off.

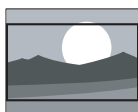

[Zoom 2]: Set the normal ratio to widescreen format. (PC mode only has options for normal, widescreen and Point to Point).



[Point to Point]: Used for HDMI connections on PCs. Will display the PC's full screen in order to achieve the best display effect.

Use timer

You can set the timer to switch the TV to standby mode at a set time.



Tip

- Before using the timer, please set the sleep timer.

Setting the sleep timer



Tip

- You can turn the TV off earlier, or reset the sleep timer before the TV switches off.

- 1 Press **⏸** **ADJUST** and select **[Setup]**.
- 2 Press **▲▼◀▶** Select **[Sleep Timer]**.
- 3 Press **▲▼** You can select a time for the sleep timer to turn the TV off.
↳ The longest time that can be set for the sleep timer is 180 minutes.

TV lock

By locking the TV remote control, you can prohibit children from watching specific programs or channels.

Setting or changing your password

- 1 Press **⏸** **ADJUST** and select **[Parental]**.
- 2 Select **[Enter Password]** or **[Change Password]**.
- 3 Use the number buttons on the remote control to enter a password.
- 4 Create or change a password by following the instructions on screen.

Locking channels

- 1 Press **⏸** **ADJUST** and select **[Parental]**.
- 2 Enter the password and select **[Channel Lock]**.
- 3 Choose a channel. Press **OK** to lock or unlock the channel.
- 4 Repeat this step to lock or unlock multiple channels.
 - **[Channel Lock]**: When channels are locked:
 - You need to enter the four digit password to enter the channel blocking menu.
 - You need to enter the four digit password to watch locked channels.
 - You need to enter the four digit password to enter the parental menu.
 - **[Clear All]**: This function will clear all the locked channels and signal sources that you have previously saved.
 - The default password is "0000". Users may change or set the password themselves.



Notes

- If you visit a locked channel, you will be prompted to enter the password.

Adjusting VGA Setup

- 1 Press **⏸** **ADJUST** and select **[VGA setting]**.
↳ The **[VGA setting]** menu will be displayed.
- 2 Press **▲▼◀▶** Select and adjust the setup:
 - **[Auto adjust]**: Automatically adjusts the TV to synchronize its resolution with that of the PC, so that programs are displayed in full screen.

- **[H.Position]**: Adjusts the horizontal position.
- **[V.Position]**: Adjusts the vertical position.
- **[Phase]**: Adjusts the phase frequency of the VGA signal.
- **[Clock]**: Adjusts the clock frequency of the VGA signal.



Tip

- The VGA menu is only visible when connected to a PC.

Playing media from USB devices

If you have photos, music or video files stored on a USB storage device, you can play the files on your TV.

Video formats supported on USB:

- Supported storage devices: USB (only FAT or FAT 32 USB storage devices are supported)
- Supported media file formats:
 - Images: JPEG
 - Audio: MP3
 - Video: MPEG 2/MPEG 4, H.264
 - Text files: TXT



Note

- TPVision shall not be liable if a USB storage device is not supported, or if the data in the device is damaged or lost.

Viewing photos and playing audio and video files

- 1 Turn on the TV.
- 2 Connect the USB storage device to the USB port on the side of the TV.
- 3 Press **⬆** (Home).
- 4 Select **[USB]** and press **OK**.
 - ↳ The USB browser will open.

Viewing photos

- 1 In the USB browser, select **[Photo]** and press **OK**.
- 2 Select a photo or folder, then press **OK**. The photo will be enlarged to fill the screen.
 - Press **CH-** or **CH+** to see the previous or next photo.

Starting slide shows

- 1 Select a photo or folder, then press **OK**. The photo will be enlarged to fill the screen.
 - ↳ The slide show starts playing from the selected photo.
- 2 Press the following buttons to control photo playback:
 - **▶** or **⏸**: Play or pause
 - **CH-** or **CH+**: See the last photo or the next photo.

Changing slide show playback setup

When you want to start playing a slide show, press **⬆ (Home)** and select one of the following options, then press **OK**.

- **[Pause/Play]**: Start or stop playback
- **[Repeat]**: Set the playback mode.
- **[Shuffle]**: Play the slide show in order or at random.
- **[Duration]**: Set the length of time that the slide show is played back.
- **[Effect]**: Set special effects to show during transitions between photos.
- **[Show Info]**: Displays the photo name, resolution, file size, date and time.

Listening to music

- 1 In the USB browser, select **[Music]** and press **OK**.
- 2 Select a song or album, then press **OK** to start playing.

Changing the music setup

When playing back music, press **⬆ (Home)** and select one of the following options, then press **OK**.

- **[Pause/Play]**: Start or stop playing music.
- **[Repeat]**: Set the playback mode.
- **[Shuffle]**: Play songs in order or at random.
- **[Show Info]**: Displays the song name, artist, file size, and other information.
- **[Show/Hide Spectrum]**: Show or hide the audio frequencies for the song.
- **[Smart Sound]**: Set the play mode for sound.
- **[Lyric Option]**: Choose whether lyrics are turned on or off, and the encoding format (cannot be selected if there are no lyrics).
- **[Audio Only]**: Turns off the screen to save energy (press any button to restore the screen).

Watching video

- 1 In the USB browser, select **[Movie]**, then press **OK**.
- 2 Press **OK** to play the video.
- 3 Use the following buttons to control the movie:
 - **▶** or **⏸**: Play or pause
 - **⏮** / **⏭**: Search forward or backward.

Viewing a text file

- 1 In the USB browser, select **[Text]**, then press **OK**.
- 2 Press **OK** to read the text file.
- 3 Use the following buttons to control text file playback:
 - **▶** or **⏸**: Play or pause
 - **⏮** / **⏭**: Search forward or backward.

Adjusting the text file view setup

When playing text files, press **⬆ (Home)** and choose one of the following options, then press **OK**.

- **[Pause/Play]**: Start or stop displaying text files.
- **[Repeat]**: Sets the display mode.
- **[Shuffle]**: Play text files in order or at random.
- **[Show Info]**: Show the name and size of the text file.

Removing USB storage devices



Note

- In order to avoid damaging the USB storage device, please follow the steps below.

- 1 Switch out of the USB browser by following the steps in the menu.
- 2 Wait for approximately five minutes before removing the USB storage device.

Updating the TV software

Philips constantly strives to improve its products, so we recommend that you update your TV software whenever an update becomes available. Please visit the website at www.philips.com/support to find out whether there are updates available.

Restoring the factory setup

You can restore your TV's default picture and sound setup. Saved channel setup will not be affected.

- 1 Press **⏏** **ADJUST**.
- 2 Press **▲▼◀▶** Select **[Setup]** > **[Reset]**.
- 3 Select **[Confirm]** and press **OK**. If you want to cancel, please select **[Cancel]** and press **OK**.

6 Setting up channels

This chapter explains how to reconfigure and fine-tune channels.

Setting up channels automatically

Automatically finds and saves channels.

- 1 Press **⏸** **ADJUST**.
- 2 Press **▲▼◀▶** Select **[TV] > [Channels] > [Channel Scan]**.
- 3 Press **OK**.
↳ The TV will automatically start searching for channels.

Updating channels

- 1 Press **⏸** **ADJUST**.
- 2 Press **▲▼◀▶** Select **[TV] > [Channels] > [Update Scan]**.
- 3 Press **OK**.
↳ The TV will start to update the channels.

Setting channels manually

You can manually find and save analog TV channels.

Finding and saving new TV channels

- 1 Press **⏸** **ADJUST**.
- 2 Press **▲▼◀▶** Select **[TV] > [Channels] > [Search for Analog Channels]**.
↳ The **[Search for Analog Channels]** menu is displayed.

- 3 Select **[Start frequency (MHz) / End Frequency (MHz)]** and use the number keys to enter the three-digit channel frequencies.
- 4 Select **[Start Search]** and press **OK**.
- 5 Press **⏪** (**Home**) **Exit**.

Skipping channels

- 1 Press **⏸** **ADJUST**.
- 2 Press **▲▼◀▶** Select **[TV] > [Channels] > [Channel Edit]**.
↳ The **[Channel Edit]** menu will be displayed.
- 3 Press **▲▼** Select the channel you wish to skip and press **OK**. Select **[Skip]**, then press **◀▶** to make the change.
- 4 If you wish to confirm, please select **[Save]** and press **OK**.
- 5 You can skip more channels by repeating the steps above. Press **OK** to start finding channels.



Tip

- Use the number buttons on the remote control to access channels that were skipped.
- If you want to watch the channel, please repeat steps 1 to 4, then press **OK** Cancel them.

Swapping channels

- 1 Press **⏸** **ADJUST**.
- 2 Press **▲▼◀▶** Select **[TV] > [Channels] > [Channel Edit]**.
↳ The **[Channel Edit]** menu will be displayed.
- 3 Press **▲▼** Select the channel you wish to swap, then press the red button.
- 4 Press **▲▼** Select the channel you wish to swap, then press the red button to confirm.

Renaming channels

You can rename channels. Selecting a channel will display its name.

- 1 Press **⏏** **ADJUST**.
- 2 Press **▲▼◀▶** Select **[TV] > [Channels]** > **[Channel Edit]**.
↳ The **[Channel Edit]** menu will be displayed.
- 3 Press **▲▼** Select the channel you wish to rename, then press the **OK** button.
- 4 Press **▲▼** Select the channel name, then press the **OK** button to enter the editing interface.
- 5 Press **▲▼◀▶** Type the new name.
- 6 Select **[Confirm]**, then **OK** to finish renaming the channel.



Tip

- Channel names can include a maximum of 6 characters.

7 TV connections

This chapter explains how to connect devices with different interfaces.

Note

- You can use different connection types to connect devices to the TV.

Rearconnections

- HDMI**
Digital audio and video input from Blu-ray players and other high definition devices

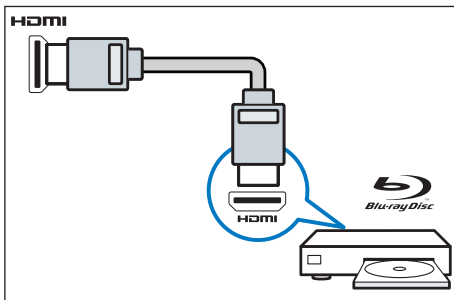

- PC inputs (VGA and audio)**

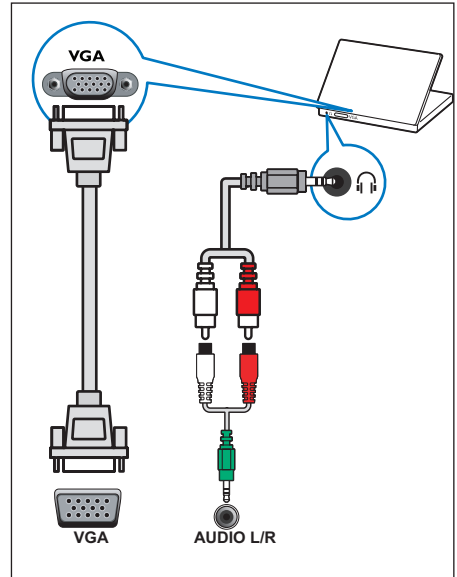

Side connections

- AV input**

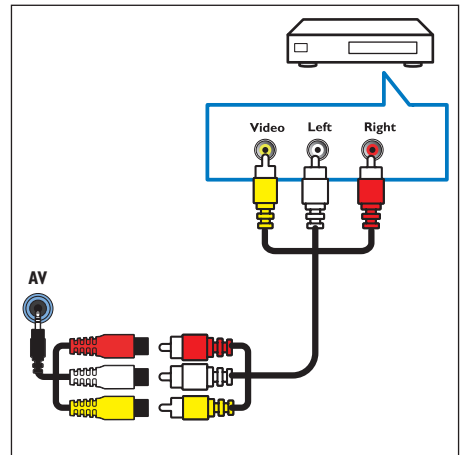

② Component signal input

Audio and video input from DVD players, game consoles and other analog or digital devices

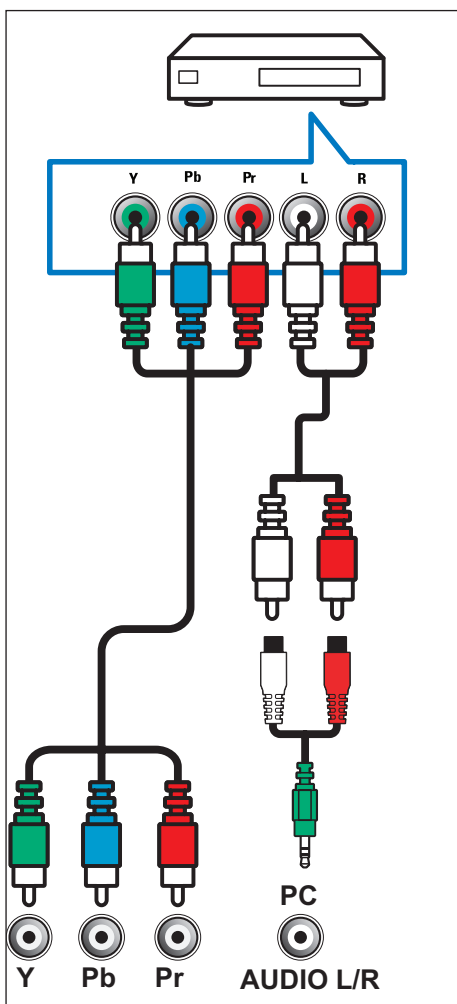

③ Headphones

Stereo sound output for headphones.

Note

- The TV speakers will automatically be muted when headphones are plugged in.

④ Antenna/cable TV

Input for an antenna, cable or satellite signal.

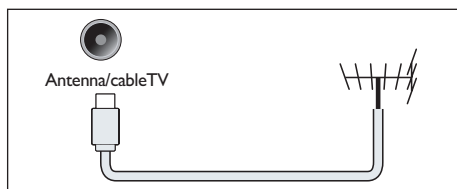

⑤ USB

Data input from a USB storage device.

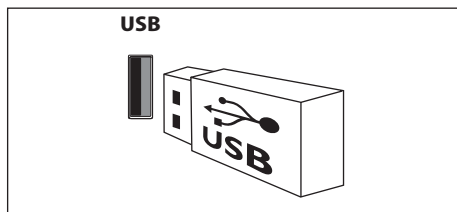

Connecting to a computer

Before connecting the computer to the TV:

- Set the computer screen refresh rate to 60Hz.
- Select a supported resolution on the computer.

Connect to the computer using one of the following connections:

Notes

- A separate audio cable is required when connecting with DVI or VGA.

- HDMI cable

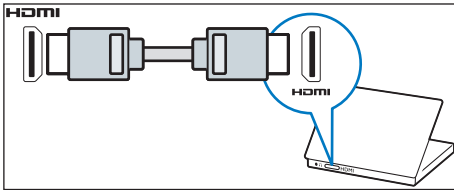

- DVI-HDMI cable

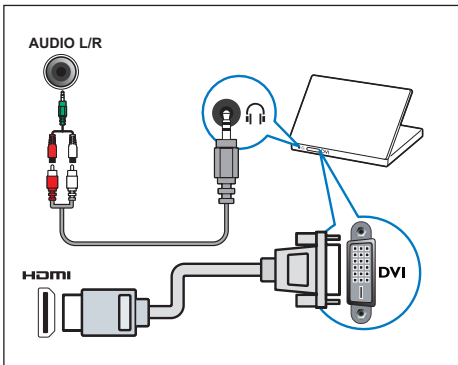

- HDMI cable and HDMI-DVI adapter

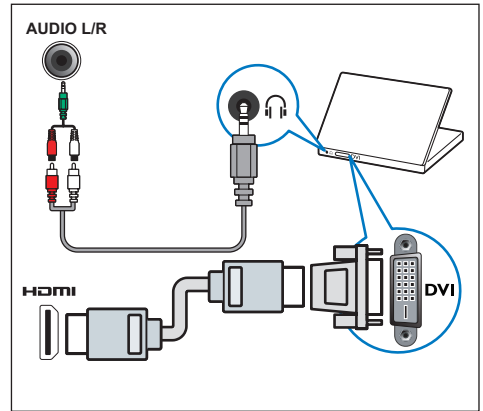

- VGA cable

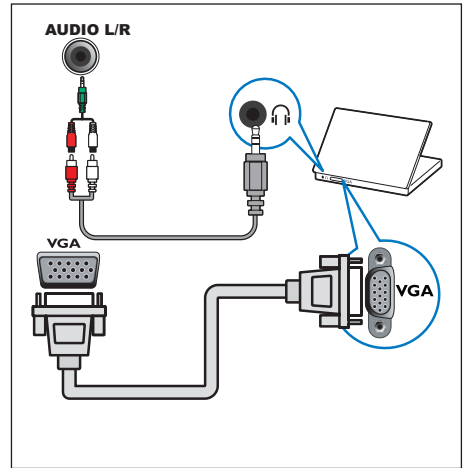

Use Philips EasyLink

Make full use of your Philips EasyLink HDMI-CEC-compatible device to improve the control features and obtain the maximum benefit. HDMI-CEC-compatible devices connected with an HDMI connection can be controlled using the TV remote control.

If you want to turn Philips EasyLink on, you must:

- Connect two or more HDMI-CEC-compatible devices using HDMI connections.
- Confirm that each HDMI-CEC-compatible device is operating normally.
- Switch to EasyLink.

Notes

- The EasyLink-compatible devices must be switched on and selected as signal sources.
- Philips does not guarantee 100% interoperability with all HDMI CEC devices.

Turning EasyLink on or off

Once an HDMI-CEC-compatible device is turned on, the TV will automatically turn on and switch to the correct signal source.

Notes

- If you do not want to use Philips EasyLink, please do not turn this function on.

- 1 Press **ADJUST**.
- 2 Press **▲▼◀▶** Select **[EasyLink]**.
- 3 Select **[Off]** or **[On]**, then press **OK**.

Using Quick Play

- 1 After enabling EasyLink, press play on the device.
 - ↳ The TV will automatically switch to the correct signal source.

Using Quick Standby

- 1 Press **(Standby — On)** on the remote control.
 - ↳ The TV and all connected HDMI devices will automatically switch to standby mode.

8 Product information

Product information is subject to change without notice. For detailed product information, please visit www.philips.com/support.

Display resolutions

Computer Formats

- Resolution - refresh rate:
 - 640 × 480 - 60Hz
 - 800 × 600 - 60Hz
 - 1024 × 768 - 60Hz
 - 1360 × 768 - 60Hz
 - 1920 × 1080 - 60Hz
(32 inches TV is not supported)

Video Formats

- Resolution - refresh rate:
 - 480i - 60Hz
 - 480p - 60Hz
 - 576i - 50Hz
 - 576p - 50Hz
 - 720p - 50Hz, 60Hz
 - 1080i - 50Hz, 60Hz
 - 1080p - 50Hz, 60Hz.

Multimedia

- Supported storage device: USB (only FAT or FAT 32 USB storage devices are supported.)
- Compatible multimedia file formats:
 - Image: JPEG
 - Audio: MP3
 - Video: MPEG 2/MPEG 4 , H.264
 - Document: TXT

Sound power

- 32PHA4509: 5W × 2
- 40PFA4509: 10W × 2
- 50PFA4509: 10W × 2

Inherent resolution

- 32PHA4509: 1366 × 768
- 40PFA4509: 1920 × 1080
- 50PFA4509: 1920 × 1080

Tuner / Reception / Transmission

- Aerial input: 75ohm coaxial (IEC75)
- TV system: NTSC, SECAM, PAL
- Video playback: NTSC, SECAM, PAL

Remote Control

- Batteries: 2 × AAA (R03 type)

Power Supply

- Mains power: 110-240V, 50-60Hz
- Standby power: ≤ 0.5 W
- Ambient temperature: 5 to 40 degrees Celsius
- Power consumption:
 - 32PHA4509: 60W
 - 40PFA4509: 80W
 - 50PFA4509: 100W

Supported TV mounts

To mount the TV, please purchase a Philips TV mount or any TV mount compliant with the VESA standard. To prevent damage to cables and connectors, be sure to leave a clearance gap of at least 2.2 inches or 5.5cm between the back of the TV to the wall.



Warning

- Please follow all instructions provided with the TV mount. TP Vision Europe B.V. bears no responsibility for improper TV mounting that results in accident, injury or damage.

Model No.	Required Pixel Pitch (mm)	Required Mounting Screws
32PHA4509	100 × 100	4 × M4 (recommended length: 15 mm)
40PFA4509	200 × 200	4 × M4 (recommended length: 16 mm)
50PFA4509	400 × 200	4 × M6 (recommended length: 22 mm)

9 Troubleshooting

This section covers common problems and their accompanying solutions.

General issues

The TV cannot be switched on:

- Disconnect the power cable from the power outlet. Wait for one minute before reconnecting it.
- Check that the power cable is securely connected.

The remote control is not working properly:

- Check that the remote control batteries are correctly inserted according to the +/- orientation.
- Replace the remote control batteries if they are flat or weak.
- Clean the remote control and TV sensor lens.

The standby light on the TV is red and blinking:

- Disconnect the power cable from the power outlet. Wait for the TV to cool down before reconnecting the power cable. If the light continues to blink, please contact Philips Customer Care Centre.

You forgot the code to unlock the TV lock feature

- Enter '3448'.

The TV menu is in the wrong language.

- Change the TV menu to your preferred language.

When turning the TV On/Off or to Standby, you hear a creaking sound from the TV chassis:

- No action is required. The creaking sound comes from the normal expansion and contraction of the TV as it cools down and warms up. This does not impact its performance.

Channel issues

Previously installed channels do not appear in the channel list:

- Check that the correct channel list is selected.

Picture issues

The TV is on, but there is no picture:

- Check that the antenna is properly connected to the TV.
- Check that the correct device is selected as the TV source.

There is sound but no picture:

- Check that the picture settings are correctly set.

Poor TV reception from the antenna connection:

- Check that the antenna is properly connected to the TV.
- Loudspeakers, unearthed audio devices, neon lights, high buildings and other large objects can influence reception quality. If possible, try to improve the reception quality by changing the antenna direction or moving devices away from the TV.
- If the reception on one particular channel is poor, please fine tune this channel.

There is poor picture quality from connected devices:

- Check that the devices are connected properly.
- Check that the picture settings are correctly set.

The TV did not save your picture settings:

- Check that the TV location is set to the home setting. This mode offers you the flexibility to change and save settings.

The picture does not fit the screen; it is too big or too small:

- Try using a different picture format.

The picture position is incorrect:

- Picture signals from some devices may not fit the screen correctly. Please check the signal output of the device.

Sound issues

The pictures are showing but sound quality is poor:

Note

- If no audio signal is detected, the TV automatically switches the audio output off - this does not indicate malfunction.

- Check that all cables are properly connected.
- Check that the volume is not set to 0.
- Check that the sound is not muted.
- Check that the sound settings are correctly set.

The pictures are showing but sound comes from one speaker only:

- Verify that sound balance is set to the centre.

HDMI connection issues

There are problems with HDMI devices:

- Please note that HDCP (High-bandwidth Digital Content Protection) support can delay the time taken for a TV to display content from a HDMI device.
- If the TV does not recognise the HDMI device and no picture is displayed, please try switching the signal source to another device before switching it back again.
- If there are intermittent sound disruptions, please check that output settings from the HDMI device are correct.
- If you are using a HDMI to DVI adapter or cable, please check if the audio cable that comes with the product is connected to AUDIO (only for mini jacks).

Computer connection issues

The computer display on the TV is not stable:

- Check that your PC uses the supported resolution and refresh rate.
- Set the TV picture format to unscaled.

Contact us

If you cannot resolve your problem, please refer to the FAQs for this model at www.philips.com/support.

If the problem remains unresolved, please contact your local Philips Customer Service Centre.



Warning

- Do not attempt to repair the TV yourself. This may cause severe injury, irreparable damage to your TV or void your warranty.



Note

- Please make a note of your TV model and serial number before you contact Philips Customer Service Centre. These numbers are printed on the back/bottom of the TV and on the packaging.



Environmental Protection Use Period

This logo labelled on the product itself indicates that the Environmental Protection Use Period thereof is 10 years.

The Environmental Protection Use Period of electrical information products refers to the time period during which the toxic and hazardous substances or elements contained within the product will not leak or suddenly spoil, and users of such products will not cause any serious environmental pollution or serious damage to human and property.

During the Environmental Protection Use Period, please use this product according to the instructions given in this user manual.

The Environmental Protection Use Period does not cover consumable parts: the battery.

Suggestive description of the Recycling Administrative Regulations for Waste Electrical and Electronics Products

In order to care and protect the Earth in a better way, please adhere to the national and applicable laws in relation to the recycling management of waste electrical and electronics products when the user no longer needs to use this product, or when it has reached the end of its product life.



© 2014 TP Vision Europe B.V.

All rights reserved.

Document order number:

Philips and the Philips' shield emblem are registered trademarks of Koninklijke Philips N.V. and are used under license from Koninklijke Philips N.V.