

请至以下互联网址注册产品  
以获得完整的信息服务

[www.philips.com/welcome](http://www.philips.com/welcome)

3330系列LED背光源液晶电视



# 快速 使用指南



X41G78SV81371A

**PHILIPS**



您的产品包装箱内应该含有下列物品：

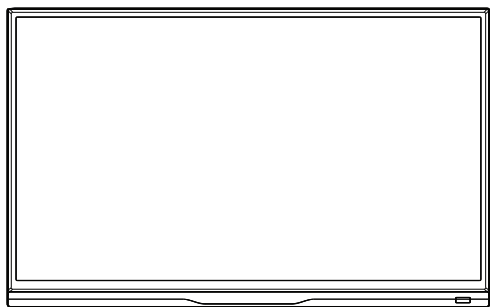

电视机

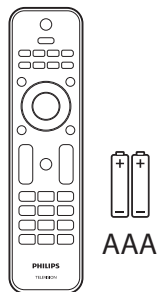

遥控器与2颗AAA电池



电源线

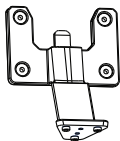

支架

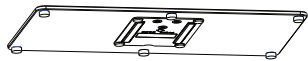

底座



快速使用指南



使用手册

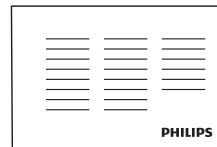

保修卡

1

电池安装方式：

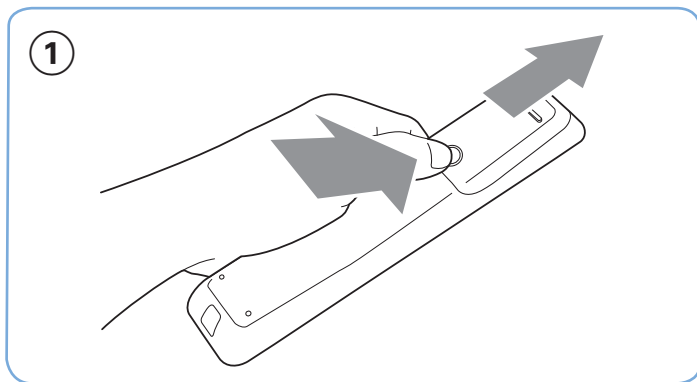

轻按压住电池盖上的圆圈，向外推开遥控器后方的电池盖

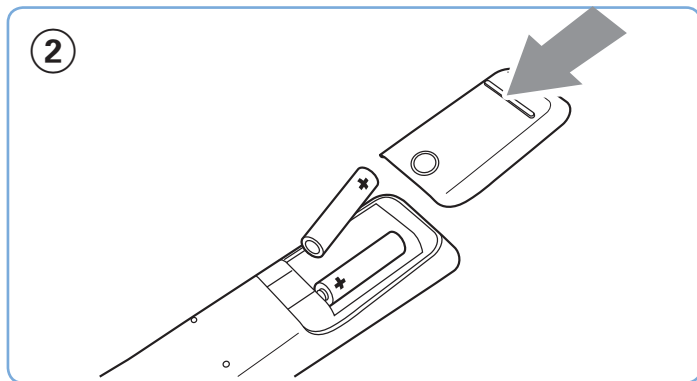

依图示放入2颗AAA电池后盖上电池盖

2



## 安装底座



步骤一：确认断开电视机所有的线缆连接；

步骤二：将电视机正面朝下放在铺有软布的稳固平整台面上，并使电视机底部边缘靠近平整台面边缘；

步骤三：从包装箱中取出底座配件并准备螺丝刀，如图示1，并注意避免滑落造成危险；



步骤四：如图示2，将支架靠近玻璃底座使其装入底座孔中，用附带的三颗螺丝（未带垫片的）将支架锁附到玻璃底座上；

步骤五：将锁附好的底座组件按图示3方式插入电视机底部中间的固定槽中；

步骤六：用四个螺丝（带有垫片的）按图示4方式，将底座组件与电视机锁紧；



再次确认各部件安装到位，螺丝全部锁紧后，将机器抬起竖立放置到稳固的平整台面上，再进行相关电缆连接及调试。因液晶面板为易碎品，此安装过程注意尽量避免触碰到液晶面板，以免造成液晶面板损伤。

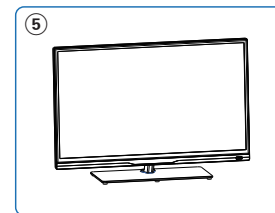
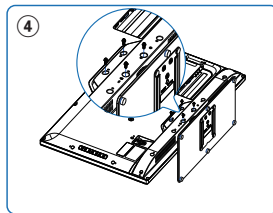
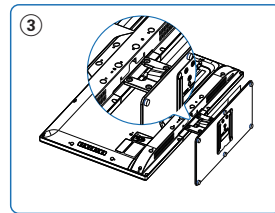
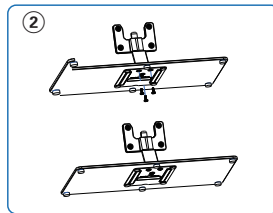
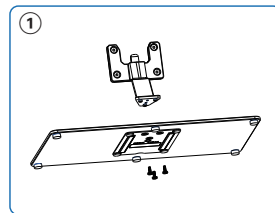
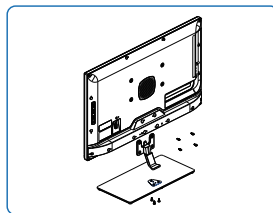

## 拆卸底座

步骤一：断开电视机所有的线缆连接；

步骤二：将电视机正面朝下放在铺有软布的稳固平整台面上，并使电视机底部边缘靠近平整台面边缘；

步骤三：松开上图示4中的四颗螺丝，取下底座组件，此过程注意避免滑落造成危险；

请保留拆卸下来的螺丝及底座组件，以便您在需要安装底座时再次使用。

## 壁挂安装

电视机壁挂安装需要用到电视机壁挂架，壁挂架需要单独购买，本机未附带。

步骤一：按上面底座拆卸方式的说明先将底座组件拆卸，若电视机尚未安装底座则略过此步骤；

步骤二：依照电视机壁挂架说明书或经由专业人士进行壁挂的安装；

3

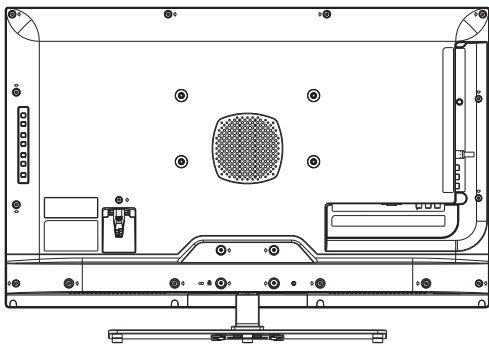

建议使用的影像端子接口:

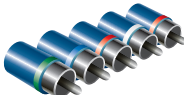
HDMI	★★★★★
	
分量信号 & 左右声道	★★★★
	
视频 & 左右声道	★
	

HDMI:  
影像画质最佳

分量端子:  
影像画质次佳

AV端子:  
影像画质普通



## 影音端子连接方式

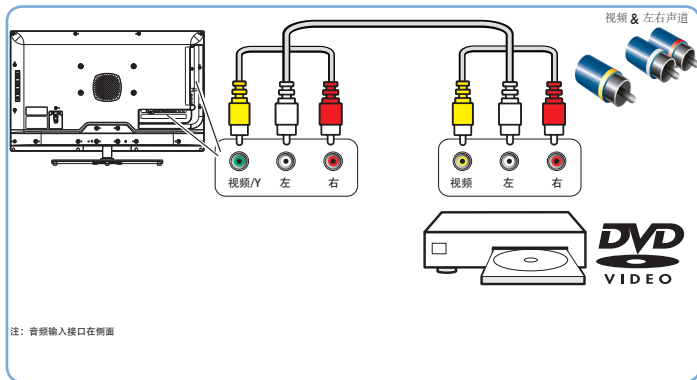
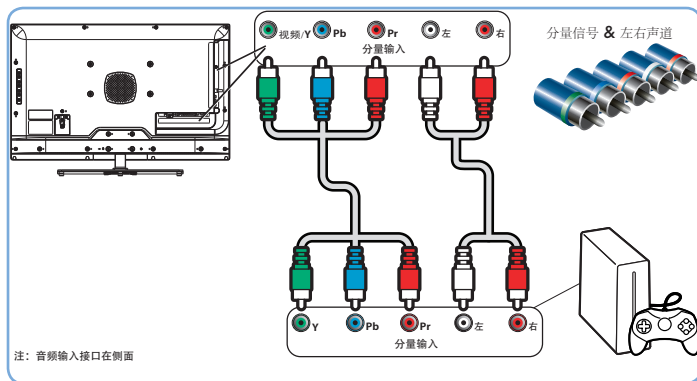
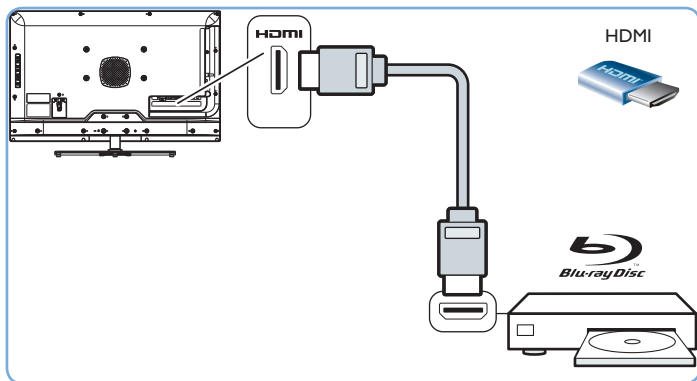

# 4

## 接上电源与电视信号

### 通过机顶盒连接

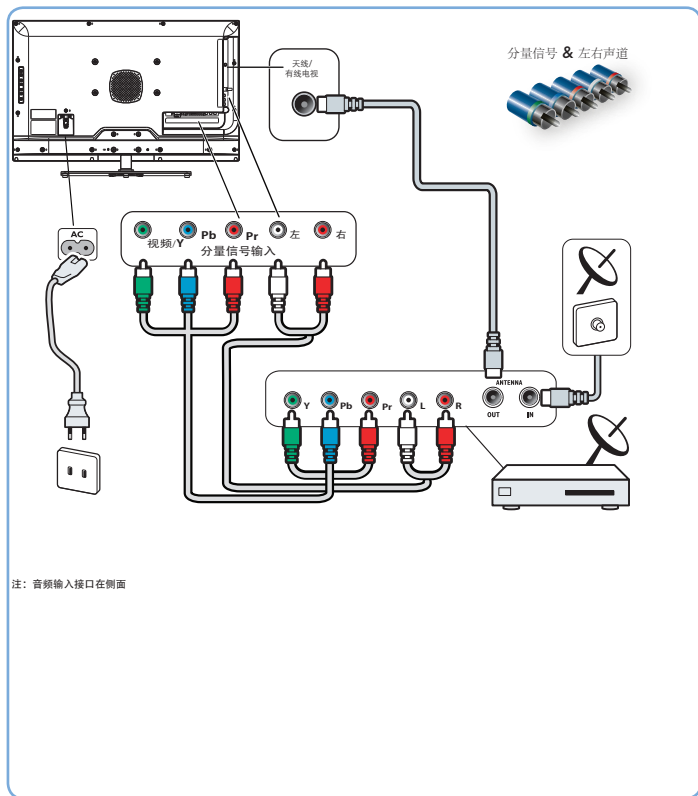

### 通过天线连接

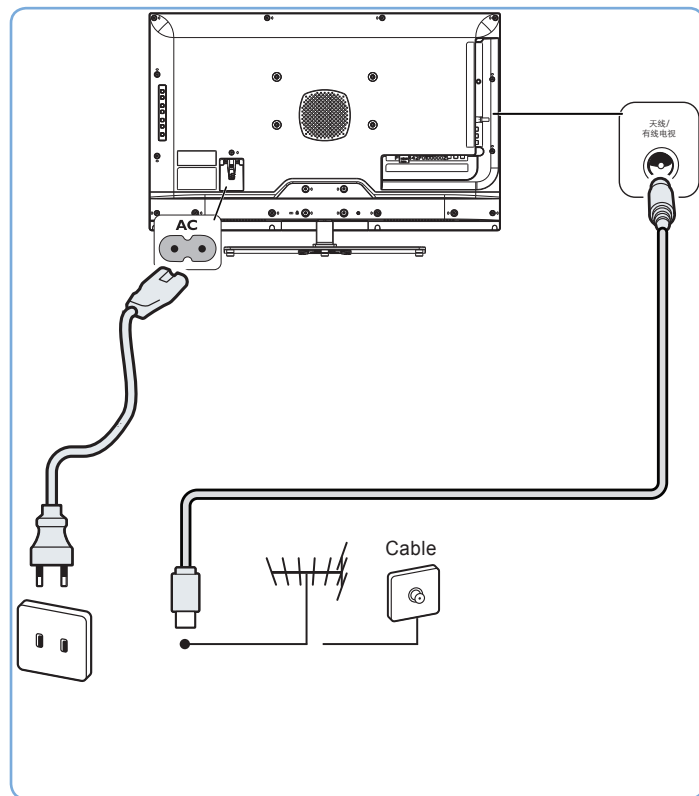



按下电源开关打开电视机

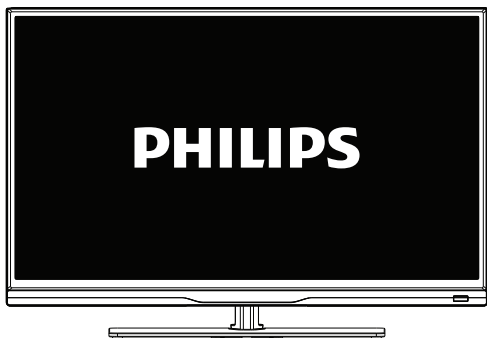
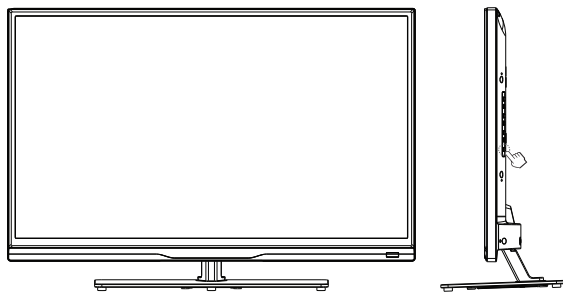

将理线夹从点2调整至适当位置1

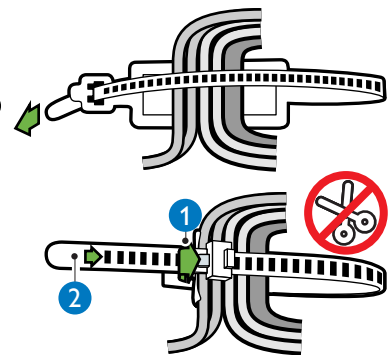
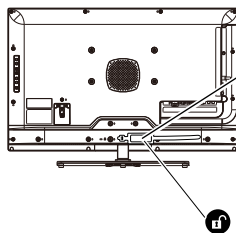



更多操作信息请参考使用手册与PHILIPS support网站。







所有注册和未注册的商标是其各自所有者的财产。  
规格如有变更，恕不另行通知。

Philips 和 Philips 盾牌图形是皇家飞利浦电子股份有限公司的注册商标，  
其使用需遵循皇家飞利浦电子股份有限公司的许可。