

Register your products and get support at  
[www.philips.com/welcome](http://www.philips.com/welcome)

4200 Series  
39PHA4251S/70

# Quick start guide

**PHILIPS**



**English**

Before using your product, read all accompanying safety information.

(The relevant parameters of instructions are variable, without prior notice, if there is any discrepancy, please in accordance with actual object.)

**Bahasa Indonesia**

Sebelum menggunakan produk, harap baca semua informasi keselamatan yang disertakan.

(Parameter yang relevan dari instruksi bisa bervariasi tanpa pemberitahuan lebih dulu, jika ada perbedaan, harap menuruti obyek yang sebenarnya.)



English

What's in the box

Bahasa Indonesia

Apa yang ada di dalam kotak kemasan

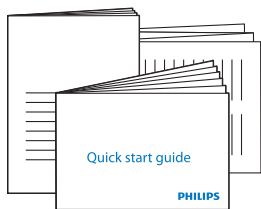

AAA

(39")

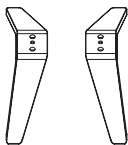
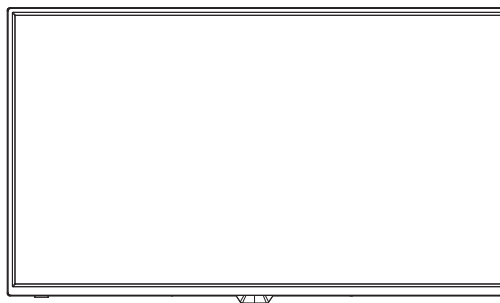

(4 pcs)

1

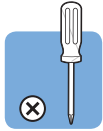

English  
Bahasa Indonesia

Mount the stand  
Pasangudukan

1  
(39")

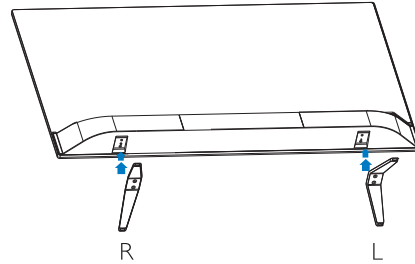

2

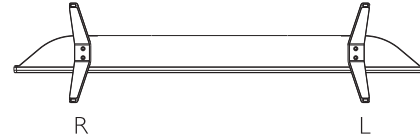

3

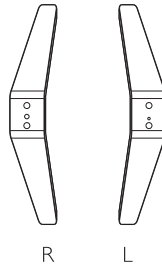
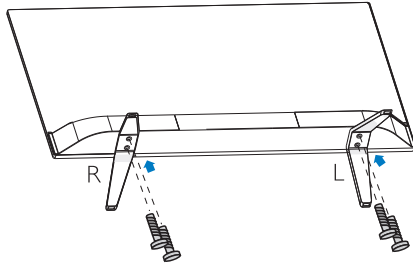

2

English Connect  
Bahasa Indonesia Hubungkan

(39")

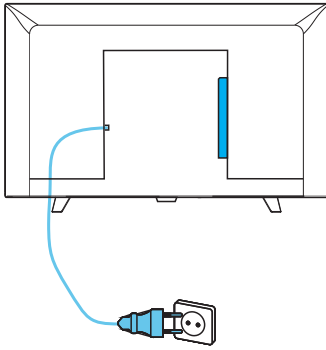

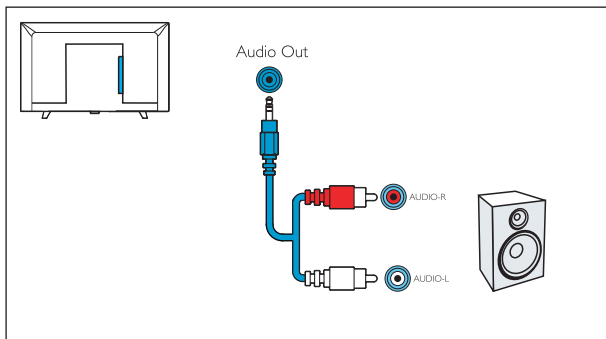
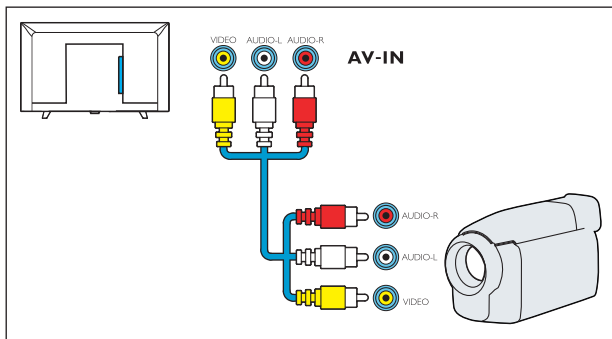
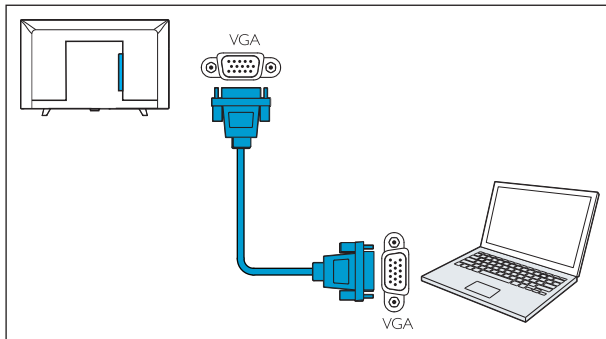
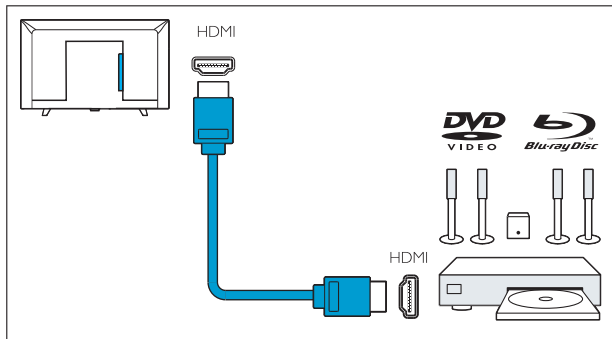

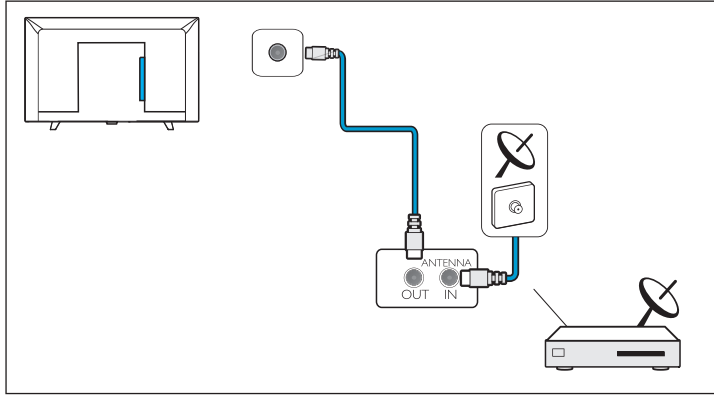

# 3

English Insert batteries  
Bahasa Indonesia Masukkan baterai

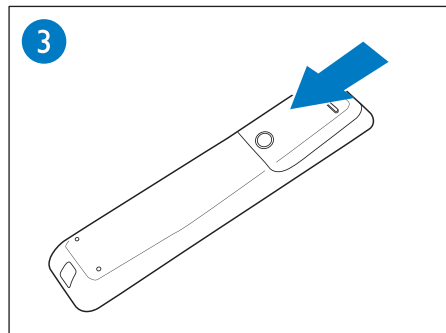
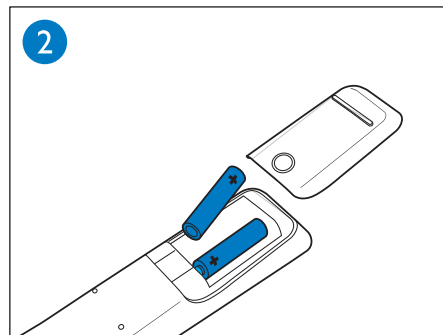
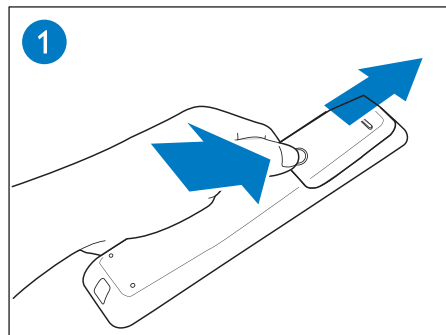





English To wall mount, purchase a suitable bracket.

Bahasa Indonesia Untuk pemasangan di dinding, belilah braket yang sesuai.

TV	H	V
98 cm / 39"	200 mm	300 mm

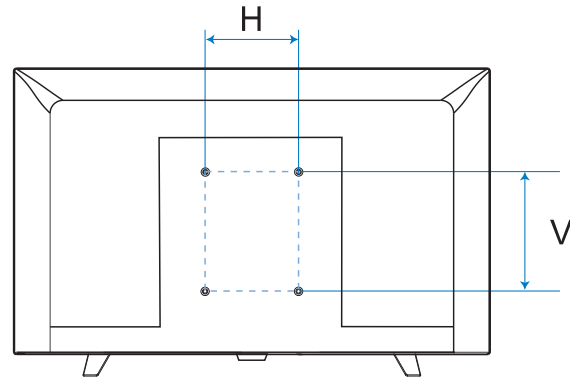

4

**English** Press the  key on the side panel of the TV or on the remote control to turn on the TV.

**Bahasa Indonesia** Tekan tombol  di panel samping TV atau di remote control untuk menghidupkan TV.

(39")

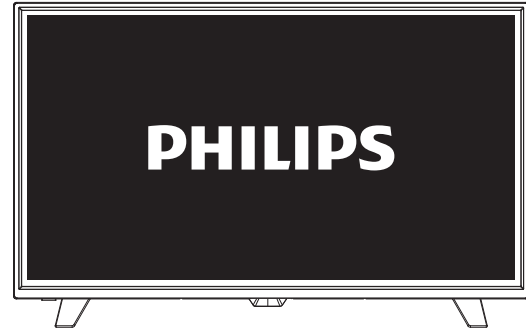
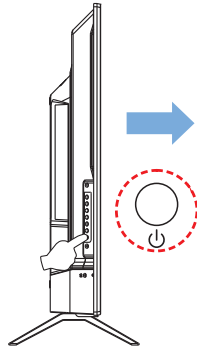
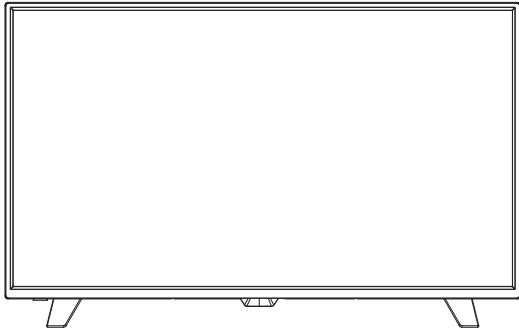



**English** Please refer to the User's Manual and the Philips support website for more operating instructions.

**Bahasa Indonesia** Silakan lihat Panduan Pengguna dan situs web dukungan Philips untuk mendapatkan petunjuk pengoperasian selengkapnya

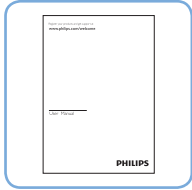



All registered and unregistered trademarks are property of their respective owners. Specifications are subject to change without notice. Philips and the Philips' shield emblem are trademarks of Koninklijke Philips N.V. and are used under license from Koninklijke Philips N.V.

2016 ©TPVision Europe B.V. All rights reserved.  
philips.com

