

Register your product and get support at  
[www.philips.com/welcome](http://www.philips.com/welcome)

# Quick start guide

4100 series - LED TV

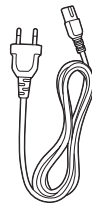
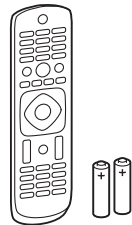
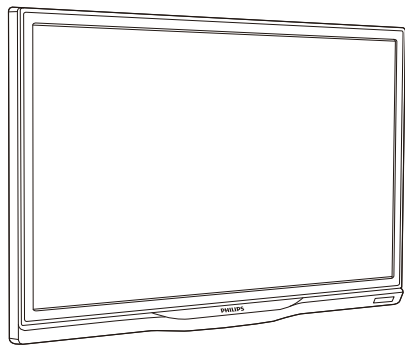

(BR)



(AR)

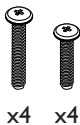
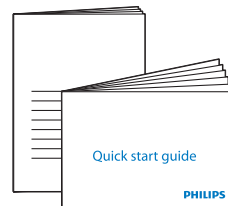

x4

x4

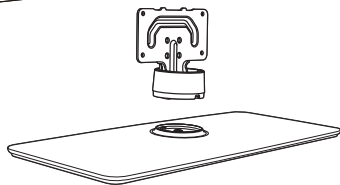

# PHILIPS



p.3

or

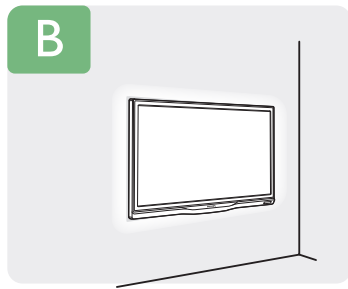

p.5



**English** Read the safety instructions.

**Português** Leia as instruções de segurança.

**Español** Lea la información de seguridad.

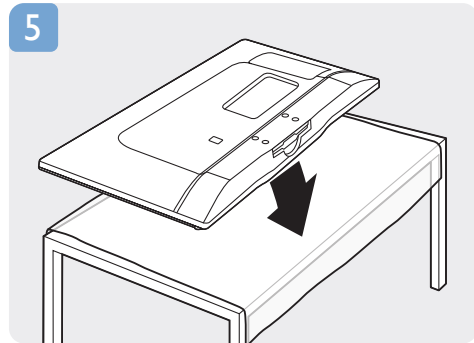
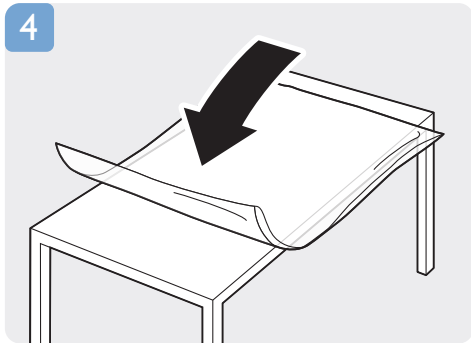
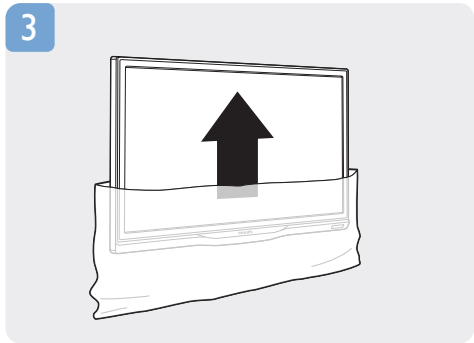
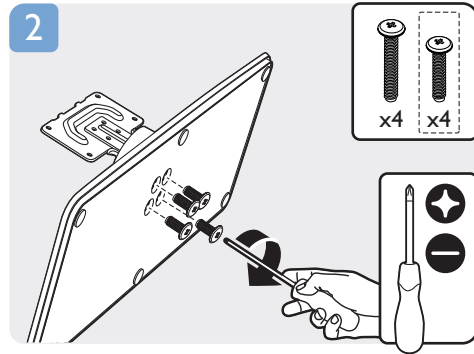
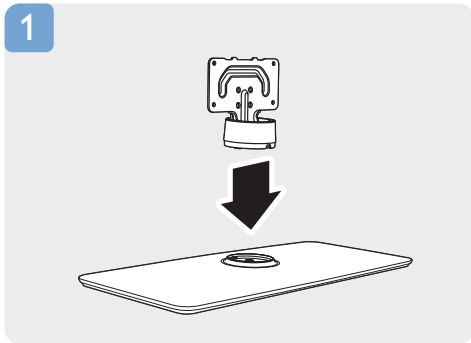
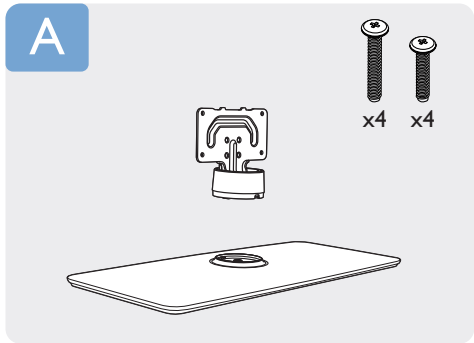

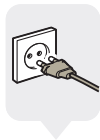
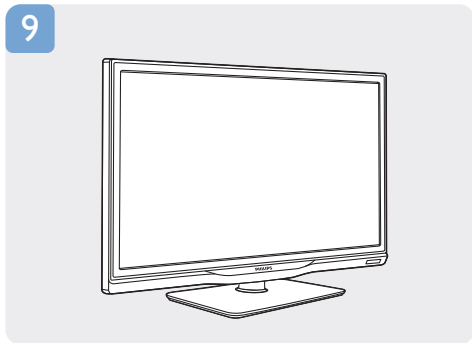
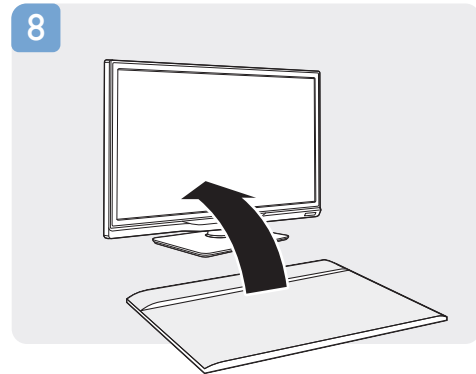
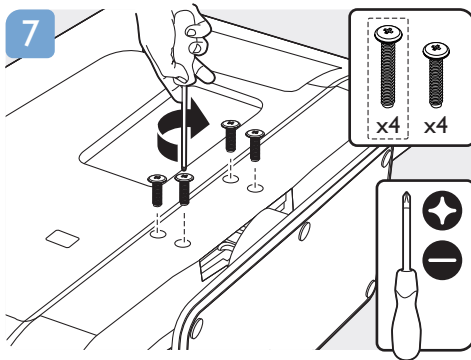
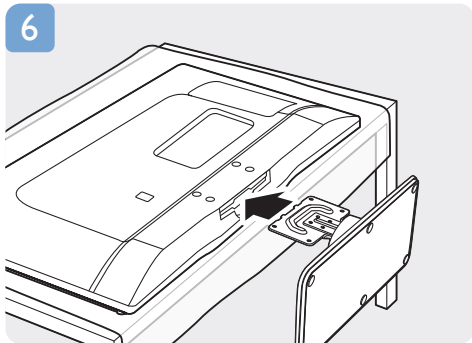

p.6

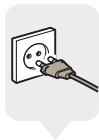
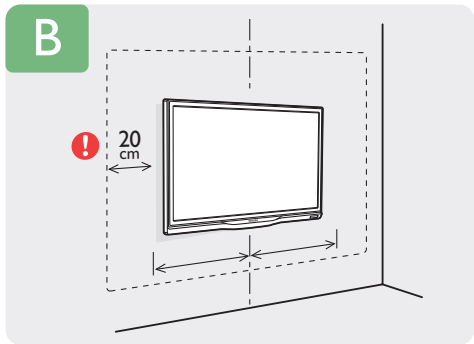

p.6

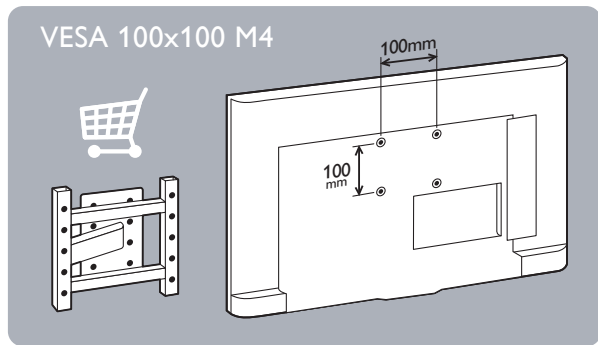

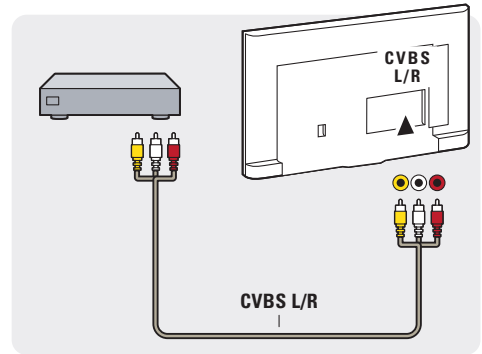
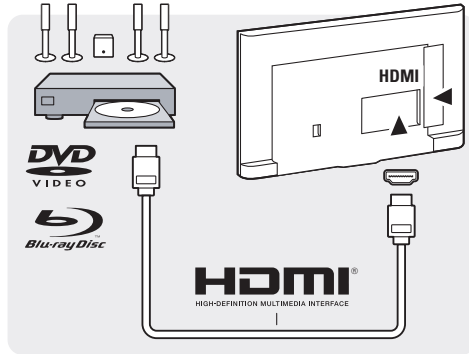
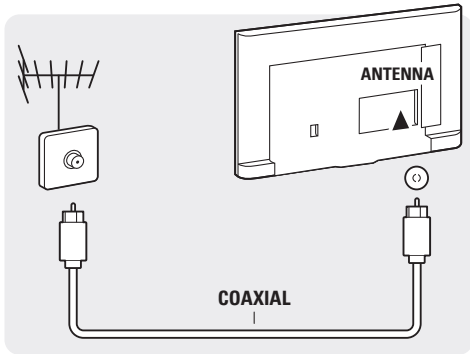
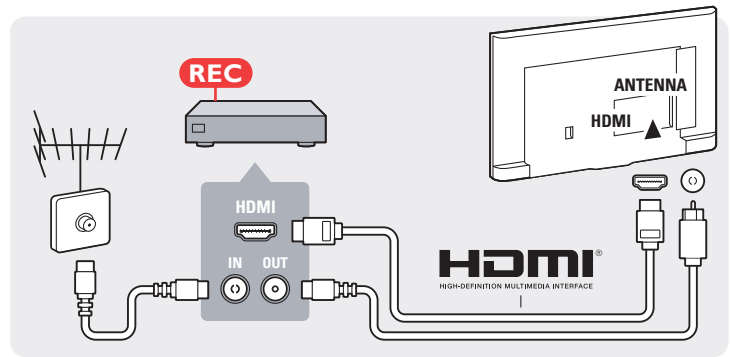
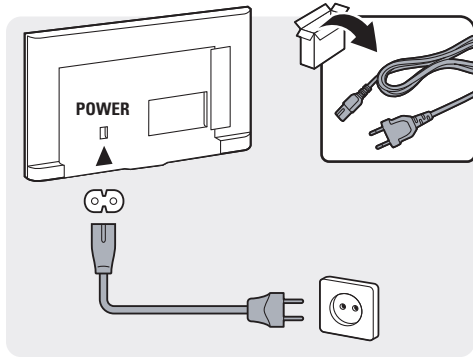
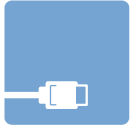

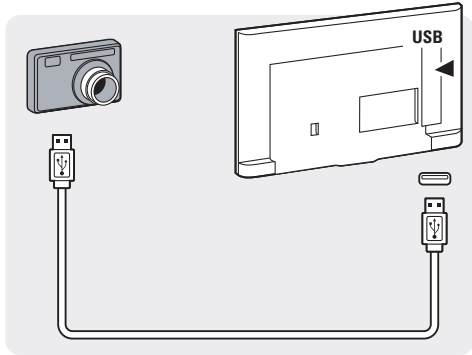
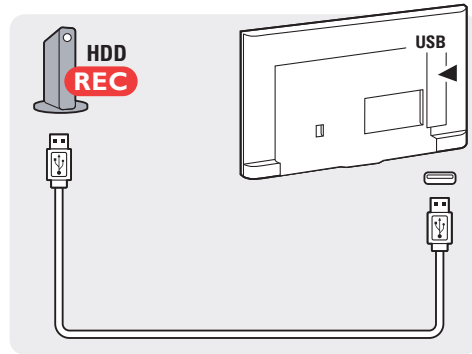
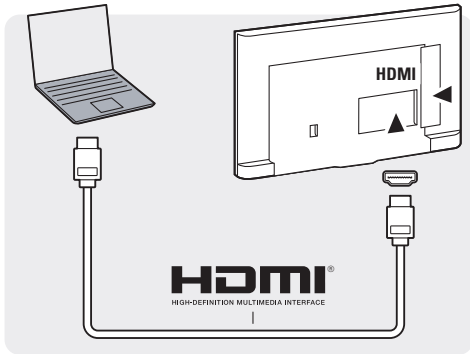
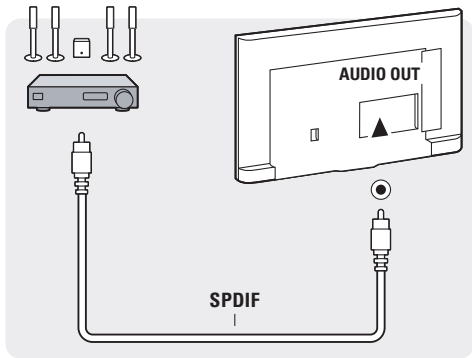

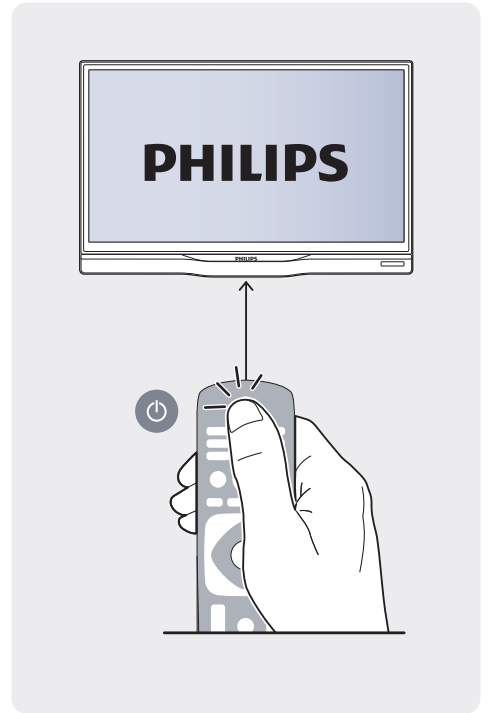
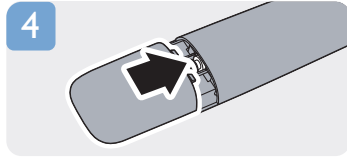
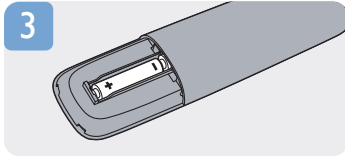
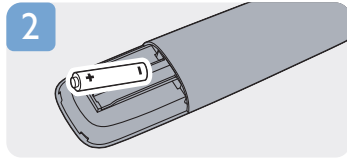
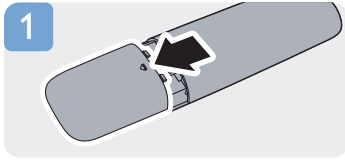





[philips.com/support](https://philips.com/support)









Always here to help you

[www.philips.com/support](http://www.philips.com/support)



User Manual



Frequently Asked Questions



Warranty



Philips support forum



Live Chat



Call Center



Email

**България**  
Грижа за клиента  
**02 4916 273**  
(Национален номер)

**België/Belgique**  
Klantenservice/  
Service Consommateurs  
**070 700 035**  
(0,15€/min.)

**Bosna i Hercegovina**  
Potpora potrošačima  
**033 941 251**  
(Lokalni poziv)

**Србија**  
Potpora potrošačima  
**011 321 6840**  
(Lokalni poziv)

**Česká republika**  
Zákaznická podpora  
**228 880 895**  
(Místní tarif)

**Danmark**  
Kundeservice  
**3525 8314**

**Deutschland**  
Kundendienst  
**069 66 80 10 10**  
(Zum Festnetztarif ihres Anbieters)

**Ελλάδα**  
Τμήμα καταναλωτών  
**2111983028**  
(Διεθνής κλήση)

**Eesti**  
Klienditugi  
**6683061**  
(Kohalikul kõned)

**España**  
Atención al consumidor  
**902 88 10 83**  
(0,10€ + 0,08€/min.)

**France**  
Service Consommateurs  
**01 57 32 40 50**  
(coût d'un appel local sauf surcoût éventuel selon opérateur réseau)

**Hrvatska**  
Potpora potrošačima  
**01 777 66 01**  
(Lokalni poziv)

**Ireland**  
Consumer Care  
**0818 210 140**  
(National call)

**Italia**  
Servizio Consumatori  
**02 45287014**  
(Chiamata nazionale)

**Қазақстан Республикасы**  
байланыс орталығы  
**810 800 2000 00 04**  
(стационарлық нөмірлерден  
Қазақстан Республикасы бойынша  
конфирмау шалу тегін)

**Latvija**  
Klientu atbalsts  
**6616 3263**  
(Vietēlais tarifs)

**Lietuva**  
Klientų palaikymo tarnyba  
**8 52140293**  
(Vietiniais tarifais)

**Luxembourg**  
Service Consommateurs  
**2487 1100**  
(Appel national)/(Nationale Ruf)

**Magyarország**  
Ügyfélszolgálat  
**(06 1) 700 8151**  
(Belföldi hívás)

**Nederland**  
Klantenservice  
**0900 202 08 71**  
(0,10€/min.)

**Norge**  
Forbrukerstøtte  
**22 97 19 14**

**Österreich**  
Kundendienst  
**0820 40 11 33**  
(0,145€/Min.)

**Республика Беларусь**  
Контатк Цэнтр  
**8 10 (800) 2000 00 04**  
(бесплатный звонок по  
Республике Беларусь со стационарных  
номеров)

**Российская Федерация**  
Контакт Центр  
**8 (800) 220 00 04**  
бесплатный звонок по России

**Polska**  
Wsparcie Klienta  
**22 3971504**  
(Połączenie lokalne)

**Portugal**  
Assistência a clientes  
**707 78 02 25**  
(0,12€/min. – Móvel 0,30€/min.)

**România**  
Serviciul Clienti  
**031 6300042**  
(Tarif local)

**Schweiz/Suisse/Svizzera**  
Kundendienst/Service Consommateurs/  
Servizio Consumatori  
**0848 000 291**  
(0,081 CHF/Min)

**Slovenija**  
Skrb za potrošnike  
**01 8888 312**  
(Lokalni klic)

**Slovensko**  
Zákaznická podpora  
**02 - 33215493**  
(vnútroštátny hovor)

**Suomi**  
Finland Kuluttajapalvelu  
**09 8862 5040**

**Sverige**  
Kundtjänst  
**08-5792 9096**

**Türkiye**  
Tüketici Hizmetleri  
**444 8 445**

**Україна**  
Служба підтримки споживачів  
**0-800-500-480**  
(звонки зі стационарних телефонів  
безкоштовні)

**United Kingdom**  
Consumer Care  
**0844 338 04 88**  
(5p/min BT landline)

**Argentina**  
Consumer Care  
**0800 444 7749**

**Buenos Aires**  
Consumer Care  
**0810 444 7782**

**Brasil**  
Suporte ao Consumidor  
**0800 701 0245**

**Brasil (São Paulo)**  
Suporte ao Consumidor  
**2938 0245**



All registered and unregistered trademarks are the property of their respective owners.

Specifications are subject to change without notice.

Philips and the Philips' Shield Emblem are registered trademarks of Koninklijke Philips N.V. and are used under license from Koninklijke Philips N.V.

2014 © TP Vision Europe B.V. All rights reserved. [www.philips.com](http://www.philips.com)

