

Register your products and get support at
www.philips.com/welcome

4000 Series

Quick start guide

PHILIPS



English

Before using your product, read all accompanying safety information.
(The relevant parameters of instructions are variable, without prior notice, if there is any discrepancy, please in accordance with actual object.)

Brazilian Portuguese

Antes de utilizar o produto, leia todas as informações de segurança que o
(Os parâmetros de instruções estão sujeitos a alterações sem aviso prévio. Se acompanharmos, houver alguma discrepância, o objeto real prevalecerá.)

Português

Antes de utilizar o nosso produto, leia toda a informação de segurança incluída.
(Os parâmetros das instruções estão sujeitos a alterações sem aviso prévio. Caso haja alguma discrepância, deverá prevalecer o objeto real.)

Deutsch

Lesen Sie vor dem Gebrauch des Geräts alle dem Produkt beiliegenden Sicherheitsinformationen durch.
(Der Inhalt dieser Anleitungen unterliegt unangekündigten Änderungen. Im Fall von Abweichungen ist das tatsächliche Produkt maßgebend.)

Français

Avant d'utiliser votre produit, veuillez lire les informations de sécurité jointes.
(Les paramètres d'instructions sont sujets à des changements sans notification préalable. En cas d'anomalie, l'objet réel prévaudra.)

العربية

قبل استخدام المنتج، اقرأ كل معلومات السلامة المرفقة
(المعلومات المناسبة للتعليمات عرضة للتغيير دون إشعار مسبق، في حالة وجود تعارض، فلارجأ الرجوع إلى المنتج الفعلي.)



English

Brazilian Portuguese

Português

Deutsch

Français

What's in the box

Conteúdo da caixa

O que está na caixa

Verpackungsinhalt

Ce que la boîte contient

العربية
ماذا في الصندوق

(32")

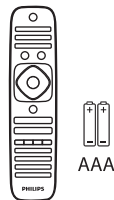
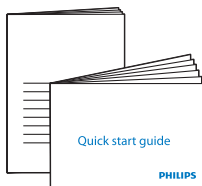
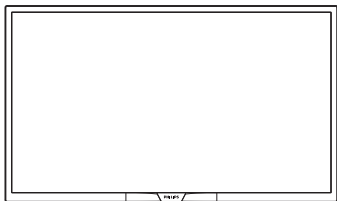

(4 pcs)

1

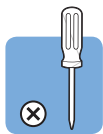

English
Brazilian Portuguese
Português
Deutsch
Français

Mount the stand
Monte o suporte
Instalar o suporte
Standfuß befestigen
Montez le support

العربية تركيب الحامل

(32")

1

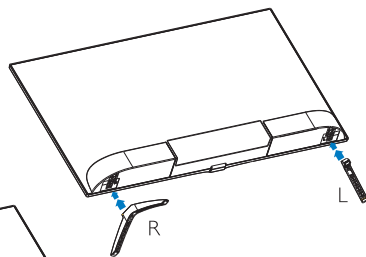

2

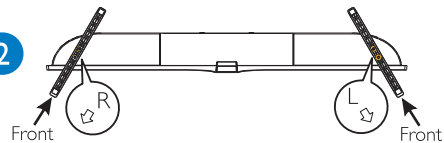

3

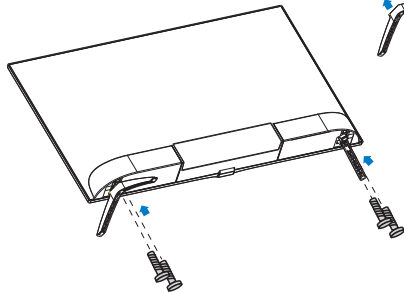

2

English Connect
Brazilian Portuguese Conecte
Português Ligar
Deutsch Verbinden
Français Connectez
العربية تركيب الحامل

(32")

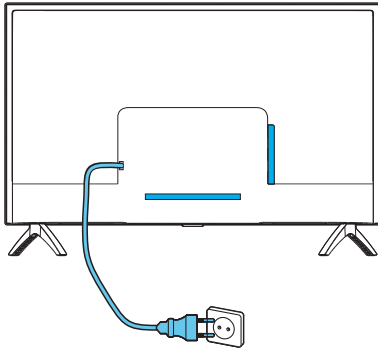

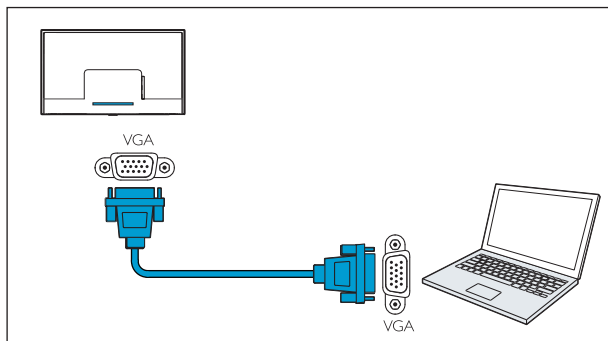
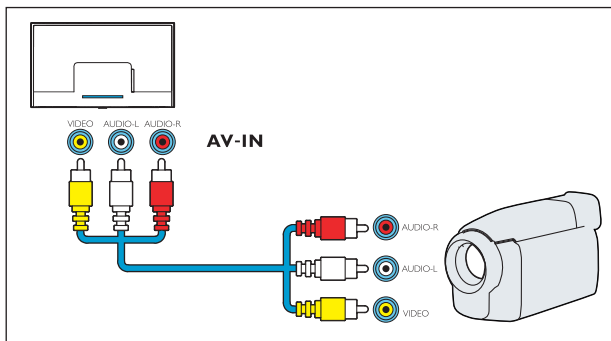
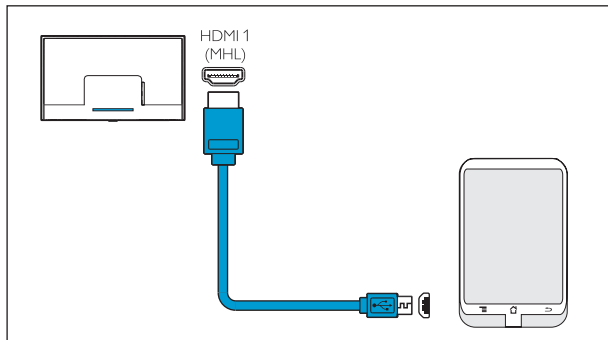
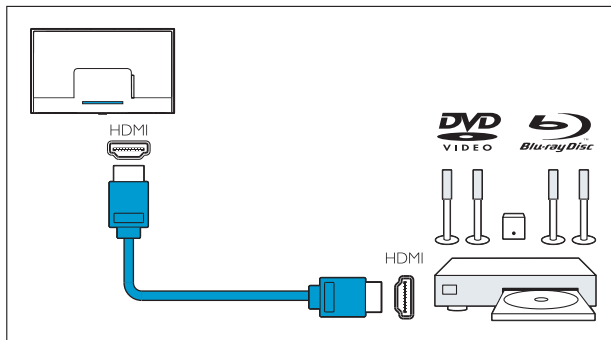

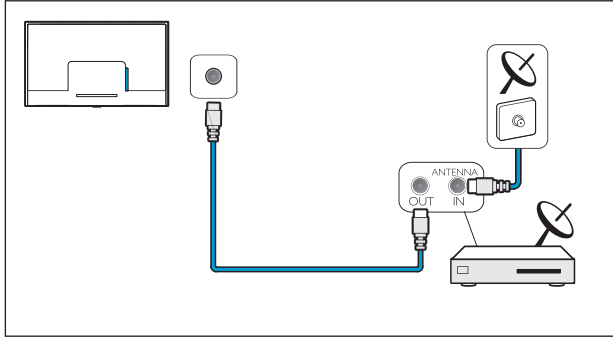

3

English
Brazilian Portuguese
Português
Deutsch
Français

Insert batteries
Insira as baterias
Inserir as pilhas
Batterien einlegen
Insérez les piles
تركيب البطاريات العربية

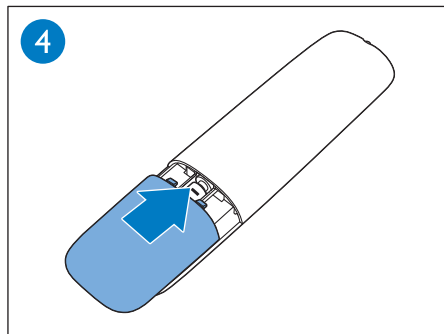
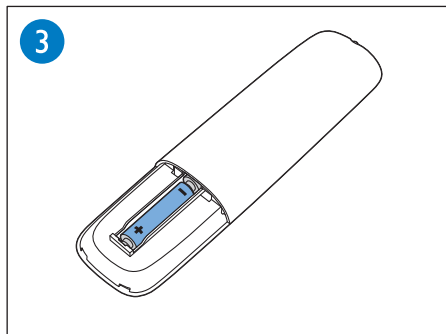
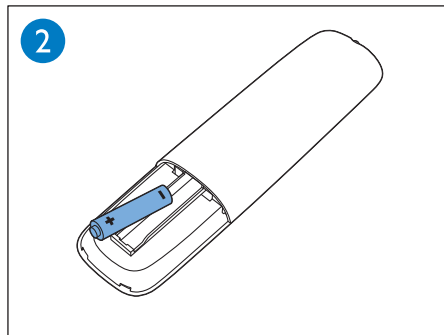
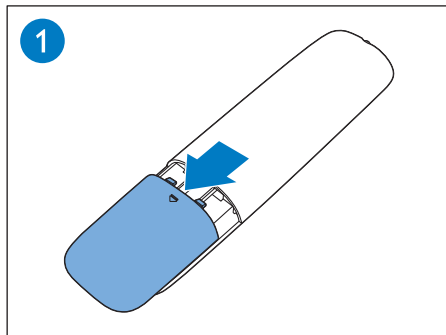



English

Brazilian Portuguese

Português

Deutsch

Français

To wall mount, purchase a suitable bracket.

Para montagem na parede, adquira um suporte de parede adequado.

Para montar na parede, adquira um suporte de montagem na parede adequado.

Für die Wandmontage kaufen Sie bitte eine geeignete Wandhalterung.

Pour une fixation murale, achetez un support mural approprié.

العربية للتركيب على الحائط، اشر حاملاً مناسباً.

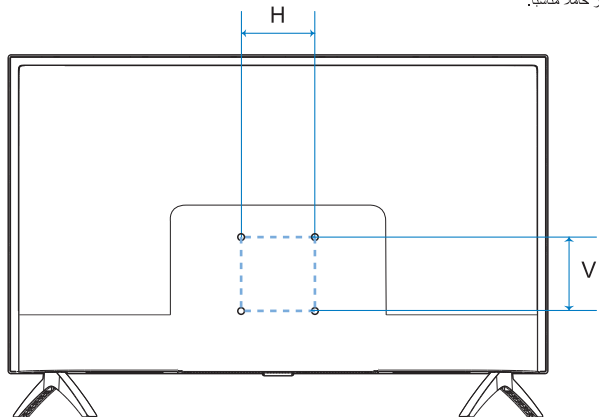

TV	H	V
80 cm / 32"	100 mm	100 mm

4

English

Brazilian Portuguese

Português

Deutsch

Français

Press the  key on the side panel of the TV or on the remote control to turn on the TV.

Pressione a tecla  no painel lateral da TV ou no controle remoto para ligar a TV.

Prima a tecla  no painel lateral da televisão ou no controle remoto para ligar a televisão.

Drücken Sie die Taste  an der Seite des Geräts oder auf der Fernbedienung, um das Fernsehgerät einzuschalten.

Appuyez sur la touche  sur le panneau latéral du téléviseur ou sur la télécommande pour allumer le téléviseur.

العربية
اضغط على مفتاح  من اللوحة الجانبية للتلفاز أو من وحدة التحكم عن بعد لتشغيل التلفاز.

(32")

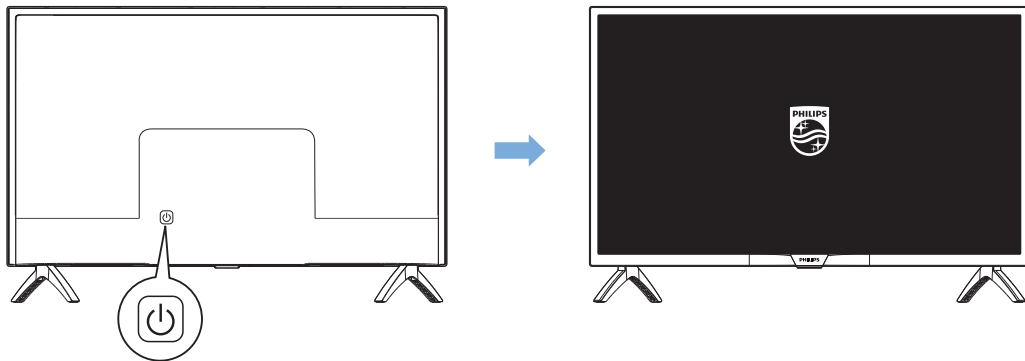



English

Brazilian Portuguese

Português

Deutsch

Français

Please refer to the User's Manual and the Philips support website for more operating instructions.

Consulte o Manual do Usuário ou o site de suporte da Philips para obter instruções de uso adicionais.

Consulte o Manual do utilizador ou o sítio Web de suporte da Philips para obter mais instruções de funcionamento.

Weitere Gebrauchsanleitungen finden Sie in der Bedienungsanleitung oder auf der Support-Webseite von Philips.

Veillez consulter le Manuel d'Utilisateur ou le site de support Philips pour plus d'instructions d'utilisation.

الرجاء الرجوع إلى دليل المستخدم وموقع ويب دعم Philips للحصول على المزيد من تعليمات التشغيل

العربية





All registered and unregistered trademarks are property of their respective owners. Specifications are subject to change without notice. Philips and the Philips' shield emblem are trademarks of Koninklijke Philips N.V. and are used under license from Koninklijke Philips N.V.

2017 © TPVision Europe B.V. All rights reserved.
philips.com

