

Register your product and get support at  
[www.philips.com/welcome](http://www.philips.com/welcome)



32PFL5605/98  
40PFL5605/98  
46PFL5605/98  
32PFL5605S/98  
40PFL5605S/98  
46PFL5605S/98

---

EN      User manual

---

**PHILIPS**

# Contents

<b>1 Notice</b>	2
<b>2 Important</b>	3
<b>3 Your TV</b>	5
Side controls and indicators	5
Remote control	5
<b>4 Use your TV</b>	8
Switch your TV on/off or to standby	8
Switch channels	8
Watch connected devices	8
Adjust TV volume	9
Use teletext	9
<b>5 Use more of your TV</b>	10
Access TV menus	10
Change picture and sound settings	10
Use advanced teletext features	13
Create and use lists of favourite channels	13
Use timers	14
Use child control	15
Use the TV clock	15
View photos, play music and watch video from a USB storage device	16
Use Scenea to display a picture as TV wallpaper	18
Update the TV software	19
Change TV preferences	19
Start a TV demo	19
Reset the TV to factory settings	19
<b>6 Install channels</b>	21
Automatically install channels	21
Manually install channels	21
Rename channels	22
Reorder channels	22
<b>7 Connect devices</b>	23
Back connectors	23
Bottom connectors	23
Side connectors	23
Connect a computer	24
Add devices	24
Use Philips EasyLink	25
Use a Kensington lock	27
<b>8 Product information</b>	28
Supported display resolutions	28
Tuner/Reception/Transmission	28
Multimedia	28
Remote control	28
Power	28
Supported TV mounts	28
Product specification	29
<b>9 Troubleshooting</b>	30
General TV issues	30
TV channel issues	30
Picture issues	30
Sound issues	31
HDMI connection issues	31
Computer connection issues	31
Contact us	31
<b>10 Index</b>	32

# 1 Notice

2010 © Koninklijke Philips Electronics N.V. All rights reserved.

Specifications are subject to change without notice. Trademarks are the property of Koninklijke Philips Electronics N.V. or their respective owners. Philips reserves the right to change products at any time without being obliged to adjust earlier supplies accordingly. The material in this manual is believed adequate for the intended use of the system. If the product, or its individual modules or procedures, are used for purposes other than those specified herein, confirmation of their validity and suitability must be obtained. Philips warrants that the material itself does not infringe any United States patents. No further warranty is expressed or implied.

Philips cannot be held responsible either for any errors in the content of this document or for any problems as a result of the content in this document. Errors reported to Philips will be corrected and published on the Philips support website as soon as possible.

## Pixel characteristics

This LCD product has a high number of colour pixels. Although it has effective pixels of 99.999% or more, black dots or bright points of light (red, green or blue) may appear constantly on the screen. This is a structural property of the display (within common industry standards) and is not a malfunction.

## Warranty

No components are user serviceable. Do not open or remove covers to the inside of the product. Repairs may only be done by Philips Service Centres and official repair shops. Failure to do so shall void any warranty, stated or implied.

Any operation expressly prohibited in this manual, any adjustments, or assembly procedures not recommended or authorised in this manual, shall void the warranty.

## Compliance with EMF

Koninklijke Philips Electronics N.V. manufactures and sells many products targeted at consumers which, like any electronic apparatus, in general have the ability to emit and receive electromagnetic signals.

One of Philips' leading Business Principles is to take all necessary health and safety measures for our products, to comply with all applicable legal requirements and to stay well within the EMF standards applicable at the time of producing the products.

Philips is committed to develop, produce and market products that cause no adverse health effects. Philips confirms that if its products are handled properly for their intended use, they are safe to use according to scientific evidence available today.

Philips plays an active role in the development of international EMF and safety standards, enabling Philips to anticipate further developments in standardisation for early integration in its products.

## Copyright



HDMI, the HDMI logo and High-Definition Multimedia Interface are trademarks or registered trademarks of HDMI Licensing LLC. ® Kensington and Micro Saver are registered US trademarks of ACCO World Corporation with issued registrations and pending applications in other countries throughout the world.

All other registered and unregistered trademarks are the property of their respective owners.

Portions of this software are copyright © The FreeType Project ([www.freetype.org](http://www.freetype.org)).

## 2 Important

Read and understand all instructions before you use your TV. If damage is caused by failure to follow instructions, the warranty does not apply.

### Safety

#### Risk of electric shock or fire!

- Never expose the TV to rain or water. Never place liquid containers, such as vases, near the TV. If liquids are spilt on or into the TV, disconnect the TV from the power outlet immediately. Contact Philips Consumer Care to have the TV checked before use.
- Never place the TV, remote control or batteries near naked flames or other heat sources, including direct sunlight. To prevent the spread of fire, keep candles or other flames away from the TV, remote control and batteries at all times.



- Never insert objects into the ventilation slots or other openings on the TV.
- When the TV is swivelled ensure that no strain is exerted on the power cord. Strain on the power cord can loosen connections and cause arcing.

#### Risk of short circuit or fire!

- Never expose the remote control or batteries to rain, water or excessive heat.
- Avoid force coming onto power plugs. Loose power plugs can cause arcing or fire.

#### Risk of injury or damage to the TV!

- Two people are required to lift and carry a TV that weighs more than 25 kg.
- When stand mounting the TV, use only the supplied stand. Secure the stand to the TV tightly. Place the TV on a flat, level surface that can support the combined weight of the TV and the stand.
- When wall mounting the TV, use only a wall mount that can support the weight of the TV. Secure the wall mount to a wall that can support the combined weight of the TV and wall mount. Koninklijke Philips Electronics N.V. bears no responsibility for improper wall mounting that result in accident, injury or damage.

#### Risk of injury to children!

Follow these precautions to prevent the TV from toppling over and causing injury to children:

- Never place the TV on a surface covered by a cloth or other material that can be pulled away.
- Ensure that no part of the TV hangs over the edge of the surface.
- Never place the TV on tall furniture (such as a bookcase) without anchoring both the furniture and TV to the wall or a suitable support.
- Educate children about the dangers of climbing on furniture to reach the TV.

#### Risk of overheating!

- Never install the TV in a confined space. Always leave a space of at least 4 inches or 10 cm around the TV for ventilation. Ensure curtains or other objects never cover the ventilation slots on the TV.

#### Risk of damage to the TV!

- Before you connect the TV to the power outlet, ensure that the power voltage matches the value printed on the back of the TV. Never connect the TV to the power outlet if the voltage is different.

### Risk of injury, fire or power cord damage!

- Never place the TV or any objects on the power cord.
- To disconnect the TV power cord easily from the power outlet, ensure that you have full access to the power cord at all times.
- When you disconnect the power cord, always pull the plug, never the cable.
- Disconnect the TV from the power outlet and antenna before lightning storms. During lightning storms, never touch any part of the TV, power cord or antenna cable.

### Risk of hearing damage!

- Avoid using earphones or headphones at high volumes or for prolonged periods of time.

### Low temperatures

- If the TV is transported in temperatures below 5°C, unpack the TV and wait until the TV temperature matches room temperature before connecting the TV to the power outlet.

---

## Screen care

- Avoid stationary images as much as possible. Stationary images are images that remain on-screen for extended periods of time. Examples include: on-screen menus, black bars and time displays. If you must use stationary images, reduce screen contrast and brightness to avoid screen damage.
- Unplug the TV before cleaning.
- Clean the TV and frame with a soft, damp cloth. Never use substances such as alcohol, chemicals or household cleaners on the TV.
- Risk of damage to the TV screen! Never touch, push, rub or strike the screen with any object.
- To avoid deformations and colour fading, wipe off water drops as soon as possible.

---

## Disposal of your old product and batteries



Your product is designed and manufactured with high quality materials and components, which can be recycled and reused.



When this crossed-out wheeled bin symbol is attached to a product it means that the product is covered by the European Directive 2002/96/EC. Please inform yourself about the local separate collection system for electrical and electronic products.

Please act according to your local rules and do not dispose of your old products with your normal household waste.

Correct disposal of your old product helps to prevent potential negative consequences for the environment and human health.



Your product contains batteries covered by the European Directive 2006/66/EC, which cannot be disposed with normal household waste.

Please inform yourself about the local rules on separate collection of batteries because correct disposal helps to prevent negative consequences for the environmental and human health.

# 3 Your TV

Congratulations on your purchase, and welcome to Philips! To fully benefit from the support that Philips offers, register your TV at [www.philips.com/welcome](http://www.philips.com/welcome).

This section gives you an overview of commonly used TV controls and functions.



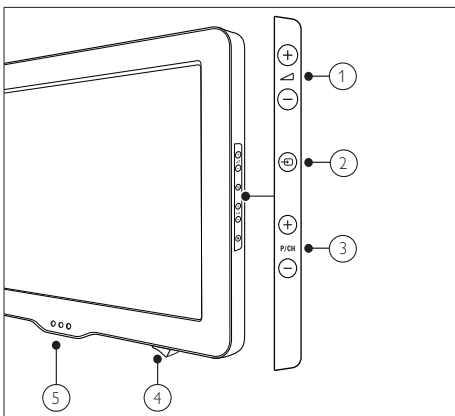





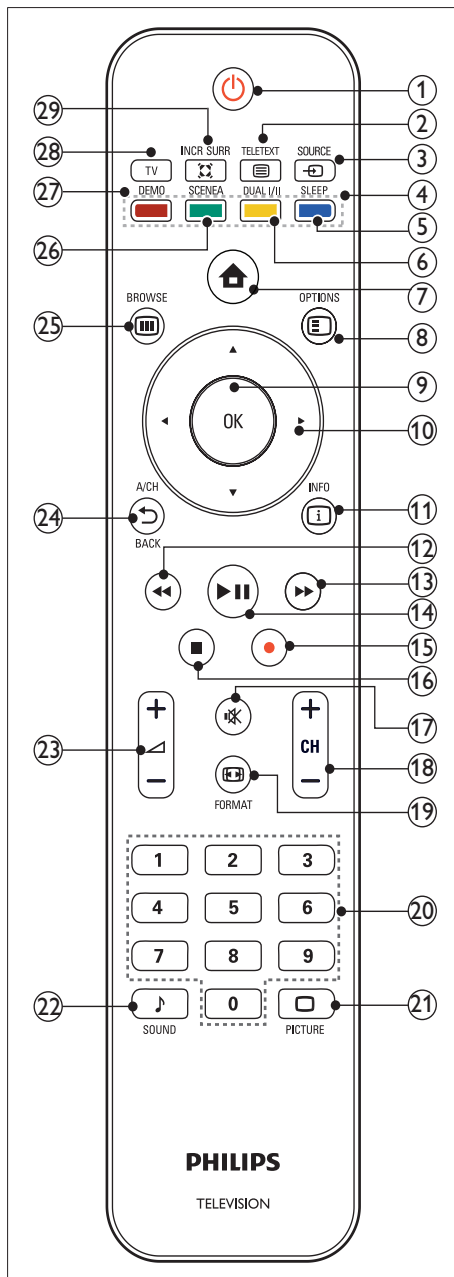











## Side controls and indicators



- ①  $\triangle$  +/-: Increases or decreases volume.
- ②  $\text{TV}$ : Selects connected devices.
- ③ P/CH +/-: Switches to the next or previous channel.
- ④ Power switch: Switches the TV on or off.
- ⑤ Ambient sensor/ Standby indicator/ Remote control sensor

## Remote control



- ①  **(Standby-On)**
  - Switches the TV to standby if it is on.
  - Switches on the TV if it is in standby.
- ②  **TELETEXT**  
Toggles teletext on or off.
- ③  **SOURCE**  
Selects connected devices.
- ④ **Colour buttons**  
Select tasks, options or teletext pages.  
Available in selected models only.
- ⑤ **SLEEP**  
Sets a delay after which the TV switches to standby.
- ⑥ **DUAL I:II**  
Switches Stereo and Nicam Stereo to Mono. Selects first language (Dual I) or second language (Dual II) in bilingual programmes.
- ⑦  **(Home)**  
Toggles the home menu on or off.
- ⑧  **OPTIONS**  
Accesses options relating to the current activity or selection.
- ⑨ **OK**  
Confirms an entry or selection. Displays a matrix of channels.
- ⑩  **(Navigation buttons)**  
Navigates menus.
- ⑪  **INFO**  
Displays programme information, if available.
- ⑫  **(Backward)**  
Searches backward.
- ⑬  **(Forward)**  
Searches forward.
- ⑭  **(Play/Pause)**  
Starts, pauses or resumes disc play.
- ⑮  **(Record)**  
Starts or stops video recording.
- ⑯  **(Stop)**  
Stops disc play.
- ⑰  **(Mute)**  
Mutes or restores volume.
- ⑱ **CH +/- (Channel +/-)**  
Switches to the next or previous channel.
- ⑲  **FORMAT**  
Selects a picture format.
- ⑳ **0-9 (Numeric buttons)**  
Selects a channel or setting.
- ㉑  **PICTURE (Smart picture)**  
Launches the smart picture menu.
- ㉒  **SOUND (Smart Sound)**  
Launches the smart sound menu.
- ㉓  **+/- (Volume +/-)**  
Increases or decreases volume.
- ㉔  **BACK A/CH**  
Returns to a previous screen.  
Toggles between the current channel and the last viewed channel.
- ㉕  **BROWSE**  
Displays a matrix of channels.
- ㉖ **SCENEA (Wallpaper)**  
Displays wallpaper on your TV screen.
- ㉗ **DEMO**  
Toggles the demonstration menu on or off.
- ㉘ **TV**  
Switches back to the antenna source from EasyLink mode.
- ㉙  **INCR. SURR**  
Enables Incredible Surround for stereo sources. Enables spatial mode for mono sources.

## Remote control usage

When using the remote control, hold it close to the TV and point it at the remote control sensor. Make sure that the line-of-sight between the remote control and TV is not blocked by furniture, walls or other objects.

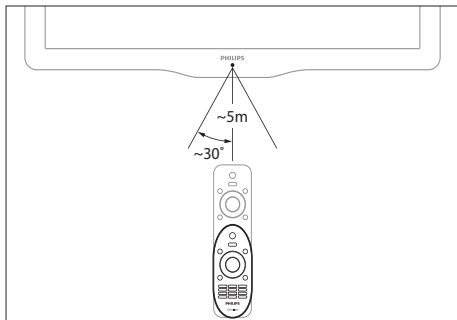



# 4 Use your TV

This section helps you perform basic TV operations.

## Switch your TV on/off or to standby

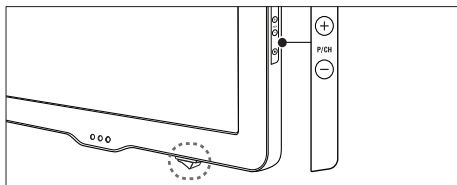

### To switch on

- If the standby indicator is off, press **Power switch** at the bottom of the TV.
- If the standby indicator is red, press **⏻ (Standby-On)** on the remote control.

### To switch to standby

- Press **⏻ (Standby-On)** on the remote control.  
↳ The standby indicator switches to red.

### To switch off

- Press the **Power switch** at the bottom of the TV.  
↳ The standby indicator switches off.



### Tip

- Though your TV consumes very little power when in standby, energy continues to be consumed. When not in use for an extended period of time, disconnect the TV power cable from the power outlet.



### Note

- If you cannot locate your remote control and want to switch on the TV from standby, press **P/CH +/-** on the side of the TV.

## Switch channels

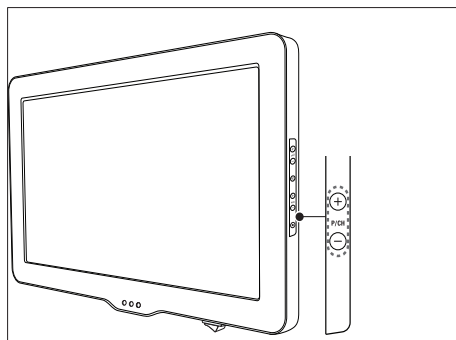

- Press **↶ BACK A/CH** on the remote control to return to the previously viewed channel.
- Press **CH +/-** on the remote control or **P/CH +/-** on the side of the TV.
- Press **OK** to use the channel matrix.
- Enter a channel number using the **Numeric buttons**.



### Note

- When you use a favourite list, you can only select those channels in the list.

## Watch connected devices

### Use the source button

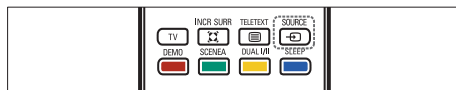

- 1 Press **⏻ SOURCE**.  
↳ The source list appears.
- 2 Press **▲** or **▼** to select the connected device.
- 3 Press **OK** to watch the connected device.

## Use the home menu

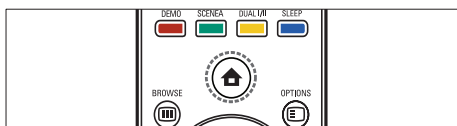

### Note

- You can add new devices to the home menu for easy access.

- Press **Home**.  
↳ The home menu appears.
- Press **▲▼◀▶** to select the device.
- Press **OK** to watch the connected device on your TV.

## Adjust TV volume

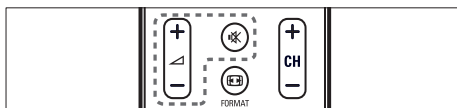
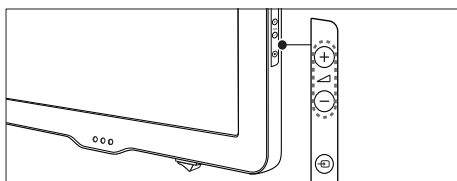

### To increase or decrease volume

- Press **▲▼** +/- on the remote control or at the side of the TV.

### To mute or unmute sound

- Press **Mute** to mute the sound.
- Press **Mute** again to restore the sound.

## Use teletext

- Press **TELETEXT**.  
↳ The main index page appears.
- Select a page as follows:
  - Press the **Numeric buttons** to enter a page number.
  - Press **CH +/-** or **▲▼** to view the next or previous page.
  - Press the **Colour buttons** to select a colour coded item.
  - Pressing **BACK** to return to the previously viewed page.
- Press **TELETEXT** to exit teletext.

# 5 Use more of your TV

## Access TV menus

Menus help you to install channels, change picture and sound settings and access other features.

## Access the home menu

The home menu gives you easy access to connected devices, picture and sound settings, and other useful features.

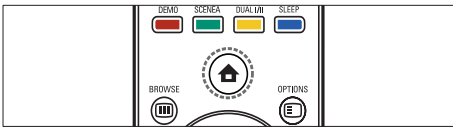

- 1 Press **Home**.  
↳ The menu screen appears.

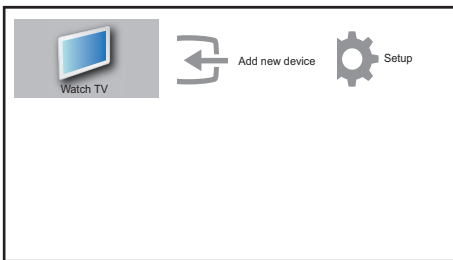

- 2 Press the **Navigation** to select and navigate through one of the following menus.
  - **[Watch TV]** : Switches back to the aerial source if another source is selected.
  - **[Setup]** : Accesses menus to change picture, sound and other settings.
  - **[Add new device]** : Adds new devices to the home menu.
- 3 Press **OK** to confirm your choice.
- 4 Press **Home** to exit.

## Tip

- After selecting **[Add new device]**, follow the on-screen instructions to select the correct device and connector.

## Remove devices from the home menu

If a device is no longer connected to the TV, remove it from the home menu.

- 1 Press **Home**.
- 2 Press **Navigation** to select a device to remove.
- 3 Press **OPTIONS**.  
↳ The **[Remove device]** list appears.
- 4 Press **OK** and select **[Remove]** to remove the device.  
↳ The selected device is removed from the home menu.

## Change picture and sound settings

Change picture and sound settings to suit your preferences. You can apply pre-defined settings or change settings manually.

## Use settings assistant

Use the settings assistant to guide you through the picture and sound settings.

- 1 Press **Home**.
- 2 Press **Navigation** to select **[Setup]** > **[Picture]** > **[Settings assistant]**.
- 3 Press **OK**.  
↳ The **[Settings assistant]** menu appears. Follow the on-screen instructions to choose your preferred picture settings.

## Use smart picture

Use smart picture to apply pre-defined picture settings.

- 1 Press **PICTURE**.  
↳ The **[Smart picture]** menu appears.
- 2 Press **▲▼** to select one of the following smart picture settings.
  - **[Personal]** : Lists customised picture settings.
  - **[Vivid]** : Applies rich and dynamic settings.
  - **[Standard]** : Adjusts picture settings to suit most environments and types of video.
  - **[Movie]** : Applies settings for movie viewing.
  - **[Game]** : Applies settings for games.
  - **[Energy saving]** : Applies low-energy settings.
- 3 Press **OK** to confirm your choice.  
↳ The selected smart picture setting is applied.

## Manually adjust picture settings

- 1 Press **Home**.
- 2 Press **▲▼◀▶** to select **[Setup]** > **[Picture]**.  
↳ The **[Picture]** menu appears.
- 3 Press **▲▼◀▶** to select from the following settings and adjust:
  - **[Smart picture]** : Accesses pre-defined smart picture settings.
  - **[Contrast]** : Adjusts the intensity of bright areas, keeping dark areas unchanged.
  - **[Brightness]** : Adjusts the intensity and details of dark areas.
  - **[Colour]** : Adjusts colour saturation.
  - **[Hue]** : Compensates for colour variations. (Available only during video playback.)
  - **[Sharpness]** : Adjusts sharpness in the image.
  - **[Noise reduction]** : Filters and reduces noise in an image.
  - **[Colour temp.]** : Sets the colour tones to **[Normal]**, **[Warm]** (reddish) or **[Cool]** (bluish).

- **[Pixel Plus HD]** : Fine-tunes each pixel to match surrounding pixels. This produces a brilliant, high-definition image.
  - **[HD Natural Motion]** : In selected models only. Reduces field and line flicker to display movement smoothly. You can switch HDNM on or off.
  - **[100Hz Clear LCD]** : Sets the TV refresh rate to a maximum of 100Hz to provide superior motion sharpness, better black level, high contrast with a flicker-free, quiet image and a larger viewing angle.
  - **[Dynamic contrast]** : Enhances contrast.
  - **[Dynamic backlight]** : Adjusts brightness of the TV backlight to match lighting conditions.
  - **[Colour enhancement]** : Makes colours more vivid and improves the details in bright colours. You can switch this feature on or off.
- **[Backlight]** : Adjusts the backlight.
- **[PC mode]** : Adjusts picture settings when a PC is connected to the TV.
- **[Light sensor]** : Adjusts settings dynamically to match lighting conditions.
- **[Picture format]** : Changes the picture format.
- **[Horizontal shift]** : Adjusts the picture horizontally for PC-VGA or HD input.
- **[Vertical shift]** : Adjusts the picture vertically for PC-VGA or HD input.

## Change picture format

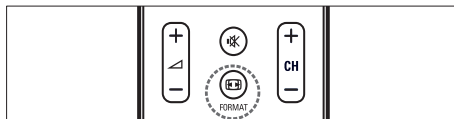

- 1 Press **FORMAT**.  
↳ A picture format bar appears.
- 2 Press **▲▼** to select a picture format.  
↳ The selected picture format is activated.

3 Press **OK** to confirm your choice.

## Summary of picture formats

The following picture settings can be configured.

### Note

- Depending on the format of the picture source, some picture settings are not available.



**[Super zoom]** : (Not for HD and PC mode.) Removes the black bars on the side of 4:3 broadcasts. There is minimal distortion.



**[4:3]** : Shows the classic 4:3 format.

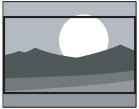

**[Movie expand 16:9]** : (Not for HD and PC mode.) Scales 4:3 format to 16:9.



**[Wide screen]** : Scales 4:3 format to 16:9.



**[Unscaled]** : For HD and PC mode only, and in selected models only. Allows maximum sharpness. Some distortion may be present due to the broadcaster's systems. Set your PC resolution to wide screen mode for best results.

## Use smart sound

Use smart sound to apply pre-defined sound settings.

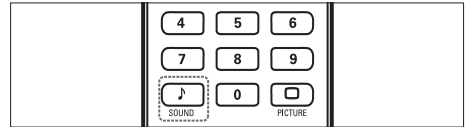

- 1 Press **J** **SOUND**.  
↳ The **[Smart sound]** menu appears.
- 2 Press **▲▼** to select one of the following smart sound settings.
  - **[Standard]** : Adjusts sound settings to suit most environments and types of audio.
  - **[News]** : Applies settings for spoken audio, such as news.
  - **[Movie]** : Applies settings for movies.
  - **[Personal]** : Applies the settings that were customised in the sound menu.
- 3 Press **OK** to confirm your choice.  
↳ The selected smart sound setting is applied.

## Manually adjust sound settings

- 1 Press **▲** (**Home**).
- 2 Press **▲▼◀▶** to select **[Setup]** > **[Sound]**.  
↳ The **[Sound]** menu appears.
- 3 Press **▲▼◀▶** to select and adjust:
  - **[Smart sound]** : Accesses pre-defined smart sound settings.
  - **[Bass]** : Adjusts the bass level.
  - **[Treble]** : Adjusts the treble level.
  - **[Volume]** : Adjusts the volume.
  - **[Balance]** : Adjusts the balance of the right and left speakers.
  - **[Dual I-II]** : Selects audio languages if dual sound broadcast is available.
  - **[Mono/Stereo]** : Selects mono or stereo if stereo broadcast is available.
  - **[TV speakers]** : Sets the TV speakers on or off, or outputs sound to an EasyLink-compliant device. This option is available when you select **[EasyLink]** in the **[Preferences]** menu.
  - **[Surround]** : Enables spatial sound.
  - **[Auto volume]** : Automatically reduces sudden volume changes, for example, when switching channels.
  - **[Delta volume]** : Corrects volume differences between TV channels and connected devices (switch

to your connected device when adjusting **[Delta volume]**).

---

## Use advanced teletext features

---

### Access the teletext options menu

Access the teletext features through the teletext options menu.

- 1 Press **☰ TELETEXT**.  
↳ The teletext screen appears.
- 2 Press **☰ OPTIONS**.  
↳ The teletext options menu appears.
- 3 Press **▲▼** to select one of the following options.
  - **[Freeze page]** : Freezes the current page.
  - **[Dual/Full screen]** : Enables and disables dual screen teletext.
  - **[Reveal]** : Hides or reveals hidden information on a page, such as solutions to riddles or puzzles.
  - **[Cycle subpage]** : Cycles through subpages automatically if subpages are available.
  - **[Language]** : Switches to a different language group to display a language correctly when it uses a different character set.
- 4 Press **OK** to confirm your choice.
- 5 Press **☰ TELETEXT** to exit the teletext options menu.

---

### Select teletext subpages

A teletext page can hold several subpages. Subpages are displayed on a bar next to the main page number.

- 1 Press **☰ TELETEXT**.  
↳ The teletext screen appears.
- 2 Select a teletext page with subpages.

- 3 Press **▶** to enter a subpage.  
↳ The subpage appears.
- 4 Press **◀▶** to switch between subpages.

---

### Select T.O.P. teletext broadcasts

Table Of Pages (T.O.P.) teletext broadcasts allow you to jump from one subject to another without using page numbers. T.O.P. teletext is not broadcast on all TV channels.

- 1 Press **☰ TELETEXT**.  
↳ The teletext screen appears.
- 2 Press **ⓘ INFO**.  
↳ The T.O.P. overview appears.
- 3 Press **▲▼◀▶** to select a subject.
- 4 Press **OK** to view the page.

---

## Create and use lists of favourite channels

You can create a list of your preferred TV channels so that you can find those channels easily.

---

### Select the favourite list



- 1 When watching TV, press **OK** to display the channel grid.
- 2 Press **☰ OPTIONS**.  
↳ The channel options menu appears.
- 3 Press **OK** to select **[Show fav. ch.]**.
- 4 Press **▲▼** to select the favourites list or **[All]**.
- 5 Press **OK**.  
↳ If you select the favourites list, only the channels in the favourites list appear in the channel grid.

↳ If you select **[All]**, all the installed channels appear in the channel grid.

6 Press **↶ BACK** to exit the menu.

---

## Add a channel to the favourite list

### Tip

- View all channels before adding a channel to the favourite list.

- 1 When watching TV, switch to the channel you want to add to a favourite list.
- 2 Press **▲▼◀▶** to select a channel to add to the favourite list.
- 3 Press **☰ OPTIONS**.  
↳ The channel options menu appears.
- 4 Press **▲▼** to select **[Mark as favourite]**.
- 5 Press **OK**.  
↳ The channel is added to the favourite list.
- 6 Press **↶ BACK** to exit.

### Tip

- When watching TV, press **☰ OPTIONS** > **[Mark as favourite]** to save the current channel in the favourite list.

---

## Remove a channel from the favourite list

### Note

- Select the favourite list to edit, before removing a channel (see 'Select the favourite list' on page 13).

- 1 When watching TV, press **OK** to display the channel grid.
- 2 Press **☰ OPTIONS**.  
↳ The channel options menu appears.
- 3 Press **▲▼** to select **[Unmark as fav.]**.
- 4 Press **OK**.

↳ The channel is removed from the favourite list.

5 Press **↶ BACK** to exit.

---

## Use timers

You can set timers to switch the TV to standby at a specified time.

---

### Automatically switch the TV to standby (sleeptimer)

Sleeptimer switches the TV to standby after a pre-defined period of time.

### Tip

- You can always switch off your TV earlier or reset the sleeptimer during the countdown.

- 1 Press **▲ (Home)**.
- 2 Press **▲▼◀▶** to select **[Setup]** > **[Features]** > **[Sleep timer]**.  
↳ The **[Sleep timer]** menu appears.
- 3 Press **◀▶** to select a value between zero and 180 minutes.  
↳ If set to zero minutes, the sleep timer is switched off.
- 4 Press **OK** to activate the sleep timer.  
↳ The TV switches to standby after the specified time.

---

### Automatically switch the TV on (on timer)

You can switch on the TV from standby to a specific channel at a specified time.

- 1 Press **▲ (Home)**.
- 2 Press **▲▼◀▶** to select **[Setup]** > **[Features]** > **[On timer]**.
- 3 Press **▲▼◀▶** to select **[Activate]** and set a frequency - **[Daily]**, **[Once]**, or **[Off]**.
- 4 Press **OK** to confirm.

- 5 Press **▲▼◀▶** to select **[Time]** and set the starting time.
- 6 Press **[Done]** to confirm.
- 7 Press **▲▼◀▶** to select **[Programme no.]** and set the channel.
- 8 Press **OK** to confirm.
- 9 Press **↶ BACK** to exit.

#### Tip

- Select **[On timer] > [Activate] > [Off]** to disable **[On timer]**.
- When **[On timer]** is **[Off]**, only **[Activate]** can be selected.
- Set the TV clock before activating **[On timer]** feature.

## Use child control

You can prevent your children from watching certain programs or certain channels by locking the TV controls.

### Set or change your PIN code

- 1 Press **🏠 (Home)**.
- 2 Press **▲▼◀▶** to select **[Setup] > [Features] > [Change/Set code]**.  
↳ The **[Change/Set code]** menu appears.
- 3 Enter the code with the **Numeric buttons**.  
↳ A message appears confirming that your code is created or changed.

#### Tip

- If you forget your code, enter '8888' to override any existing codes.

### Lock or unlock the TV

Lock the TV to prevent access to all channels and connected devices.

- 1 Press **🏠 (Home)**.

- 2 Press **▲▼◀▶** to select **[Setup] > [Features] > [TV lock]**.  
↳ A screen appears prompting you to enter a code.
- 3 Enter your code using **Numeric buttons**.
- 4 Press **▲▼** to select **[Lock]** or **[Unlock]**.
- 5 Press **OK**.  
↳ All channels and connected devices are locked or unlocked.

#### Note

- If you select **[Lock]**, you have to enter your code every time you turn on your TV.

### Lock or unlock one or more channels

- 1 When watching TV, press **OK** to display the channel grid.
- 2 Press **▲▼◀▶** to select a channel to lock or unlock.
- 3 Press **☰ OPTIONS**.
- 4 Press **▲▼** to select **[Lock channel]** or **[Unlock channel]**.
- 5 For each selection, press **OK** to lock or unlock the channel.

#### Note

- Restart the TV for the change to take effect.

## Use the TV clock

You can display a clock on the TV screen. The clock displays the current time using time data received from your TV service operator.

### Display the TV clock

- 1 When watching TV, press **☰ OPTIONS**.  
↳ The TV options menu appears.
- 2 Select **[Clock]**.
- 3 Press **OK**.  
↳ The clock is displayed.



### Note

- The clock is disabled automatically after five seconds. To disable the clock before that, repeat this procedure.

## View photos, play music and watch video from a USB storage device

### Caution

- Philips is not responsible if the USB storage device is not supported, nor is it responsible for damage or loss of data from the device.

Your TV has a USB connector that enables you to view photos, listen to music or watch movies stored on a USB storage device.

Playback type	Supported file formats
Pictures	JPEG (non-progressive only)
Music	MP3
Video	MP4, RM

### Note

- Only FAT or DOS-formatted USB storage devices are supported. File names must not exceed 128 characters.

## Browse the USB storage device

- 1 Turn on the TV.
- 2 Connect the USB storage device to the TV.
- 3 Press **Home**.  
↳ The home menu appears.
- 4 Press **▲▼◀▶** to select **[Browse USB]**.
- 5 Press **OK** to confirm.  
↳ The USB content browser appears.

### Tip

- Press **⏏ BROWSE** to switch between thumbnail and file browsing views.

## Disconnect a USB storage device

### Caution

- Follow this procedure to avoid damage to your USB storage device.

- 1 Press **Home** to exit the **[USB]** menu.
- 2 Wait for five seconds before disconnecting the USB storage device.

## View photos

- 1 In the USB content browser, select **[Picture]** and press **▶** to enter.
- 2 Press **⏏ BROWSE** to switch between thumbnail and file browsing views.
- 3 Press **▲▼◀▶** to select a photo.
- 4 Press **OK** to view the selected photo in full screen mode.

### Tip

- When in full screen mode, press **◀▶** to move between photos.

## View a slide show of your photos

- 1 When a full screen image of a photo is displayed, press **OK** or **▶||**.  
↳ A slide show begins from the selected image.
- 2 Press:
  - **OK** or **▶||** to pause the slide show.

↳ The **||** icon appears.

- Press **◀** or **▶** to move between images.
- Press **BACK** or **■** to stop the slide show.

---

## Change slide show settings

**1** When viewing a slide show, press **☰**  
**OPTIONS**.  
↳ The slide show options menu appears.

- 2** Press **▲▼** to select one of the following.
- **[Start/Stop slide.]** : Starts or stops a slide show.
  - **[Slideshow trans.]** : Sets the transition from one picture to the next.
  - **[Slideshow freq.]** : Sets the amount of time that a picture is shown.
  - **[Rotate image]** : Rotates a picture.
  - **[Set as wallpaper]** : Sets the image as wallpaper.
  - **[Show info]** : Displays the picture name, date and size of the picture in the slide show.

**3** Press **OK** to confirm your setting.

### **☰** Note

- **[Rotate image]** and **[Show info]** appear only when you press **OK** or **▶||** to pause the slide show.

---

## Listen to music

- 1** Connect a USB storage device to the TV.
- 2** Press **▶** to enter the menu.
- 3** Select **[Music]**, and then press **▶** to enter the **[Music]** folder.
- 4** Press **▲** or **▼** to select a song.

- 5** Press **OK** or **▶||** to play the song.
  - Press **OK** or **▶||** to pause, press **OK** or **▶||** again to resume.
  - Press **▶▶** to search-forward.
  - Press **◀◀** to search-backward.
  - Press **■** to stop playback.

---

## View a slideshow with music

You can view a picture slide show with background music.

- 1** While the TV is on, connect the USB storage device containing your pictures and the music to the TV.
- 2** Press **▲** (**Home**).
- 3** Press **▲▼◀▶** to select **[Browse USB]** > **[Music]**.
- 4** Press **▲▼◀▶** to select an album of songs and press **OK**.
- 5** Press **↶** **BACK** to return to the USB content browser.
- 6** Press **▲▼◀▶** to select **[Picture]**.
- 7** Press **▲▼◀▶** to select an album of pictures and press **OK**.

---

## Watch video from a USB device

- 1** In the USB content browser, press **▶** to enter the **[Video]** folder.
- 2** Press **▲▼◀▶** to select a video.

- 3 Press **OK** or **▶||** to play the video.
  - Press **OK** or **▶||** to pause, press **OK** or **▶||** again to resume.
  - Press **▶▶** to search-forward.
  - Press **◀◀** to search-backward.
  - Press **■** to stop playback.

## Use Scenea to display a picture as TV wallpaper

You can use Scenea to display a picture as wallpaper on your TV. Make sure that the location of your TV is set to home (see 'Change TV preferences' on page 19).

### Activate Scenea



### Single-picture wallpaper

Press **SCENEA** on your remote control.

- ↳ The default or pre-loaded picture is displayed.

### Note

- To deactivate the wallpaper, press any remote control button except **⏻**, **▶** **SMART SOUND**, or **□** **SMART PIC**.
- The wallpaper is also deactivated when you connect a USB storage device to the TV or start an EasyLink-compliant device through one-touch play.

### Wallpaper slide show

Make sure the wallpaper is not yet activated.

- 1 Connect a USB storage device to the TV.
- 2 Press **SCENEA**.

- ↳ All pictures in the USB storage device are displayed.

### Note

- If the sleep timer is off, the wallpaper is displayed for 120 minutes. Otherwise, it is displayed for the duration of the sleep timer.

## Upload a wallpaper picture from a USB device

Make sure your USB storage device contains a picture of less than 1MB.

- 1 While the TV is on, connect the USB storage device containing your pictures to the USB connector at the side of your TV.
- 2 Press **⌂** (**Home**).
  - ↳ The home menu appears.
- 3 Press **▲▼◀▶** to select **[Browse USB]**.
- 4 Press **▲▼◀▶** to navigate to the picture of your choice.
- 5 Press **SCENEA**.
  - ↳ Your picture is stored as the default Scenea picture in your TV.
- 6 Disconnect the USB storage device.

## Adjust wallpaper settings

- 1 Press **⌂** (**Home**).
- 2 Select **[Setup] > [Features] > [Scenea]**.
- 3 Press **▲▼◀▶** to select from the following settings:
  - **[Activate]** : Enters the Scenea mode.
  - **[ECO]** : Applies low-energy settings. Select **[On]** to display wallpaper with lower brightness.

### Note

- Select the **[ECO]** setting before you select **[Activate]** to display Scenea wallpaper.

## Update the TV software

Philips continuously tries to improve its products and we recommend that you update the TV software when updates are available. Check [www.philips.com/support](http://www.philips.com/support) for availability.

### Check the current software version

- 1 Press **Home**.
- 2 Select **[Setup] > [Software update] > [Current software]**.

### Download the software

- 1 On your PC, open a web browser and go to [www.philips.com/support](http://www.philips.com/support).
- 2 Download the latest software upgrade file to your PC.
- 3 Decompress the ZIP-file.
- 4 Copy the autorun.upg file to the root directory of the USB device.

### Update software (analogue broadcasts)

Before you perform this procedure, make sure you have:

- Enough time to complete the entire update.
- A USB storage device with at least 64MB of storage space.
- Access to a computer with a USB port and internet access.

- 1 Switch on the TV set.
- 2 Connect the USB storage device to the TV.
- 3 Press **▲▼◀▶** to select **[Setup] > [Software update] > [Local update]**.
- 4 Press **OK**.
- 5 Follow the on-screen instructions to complete the software update.

## Change TV preferences

The **[Preferences]** menu allows you to customise various features and functions.

- 1 Press **Home**.
- 2 Select **[Setup] > [Installation] > [Preferences]**.
  - **[Location]** : Optimises TV settings for your location - home or shop.
  - **[Volume bar]** : Displays the volume bar when you adjust the volume.
  - **[EasyLink]** : Enables one-touch play and one-touch standby between EasyLink-compliant devices.
  - **[Pixel Plus Link]** : Overrides the settings of connected devices and uses the settings of the TV.
  - **[E-sticker]** : For shop mode only. Sets the location of the e-sticker.

## Start a TV demo

You can use demonstrations to better understand the features of your TV. Some demos are not available on certain models. Available demos are displayed in the menu list.

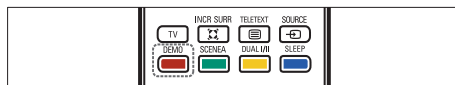

- 1 Press **DEMO** on the remote control.
- 2 Press **▲▼** to select a demo and press **OK** to view it.
- 3 Press **DEMO** to exit.

## Reset the TV to factory settings

You can restore the default picture and sound settings of your TV. The channel installation settings remain the same.

- 1 Press **Home**.

- 2 Select [Setup] > [Installation] > [Factory settings].
- 3 Press **OK** or **▶** to enter the [Factory settings] menu.  
↳ [Reset] is highlighted.
- 4 Press **OK** to reset to factory settings.
- 5 Press **⬆** (**Home**) to exit.

## 6 Install channels

### Automatically install channels

This section describes how to search and store channels automatically.

- 1 Press **Home**.
- 2 Select **[Installation] > [Channel install.] > [Channel assistant]**.
- 3 Press **OK**.
- 4 Follow the on-screen instructions to install channels.

### Manually install channels

This section describes how to search and store analogue TV channels manually.

#### Step 1 Select the colour and sound system

- 1 Press **Home**.
- 2 Press **▲▼◀▶** to select **[Setup] > [Installation] > [Channel install.] > [Analogue: Manual]**.  
↳ The **[Analogue: Manual]** menu appears.
- 3 Press **▲▼◀▶** to select and enter **[Colour system]**.  
↳ A list of available colour systems appears.
- 4 Press **▲▼** to select your colour system and then press **OK**.
- 5 Press **◀** to return to the **[Analogue: Manual]** menu.
- 6 Press **▲▼◀▶** to select and enter **[Sound system]**.  
↳ A list of available sound systems appears.
- 7 Press **▲▼** to select your sound system and then press **OK**.

#### Step 2 Search and store new TV channels

- 1 Press **Home**.
- 2 Press **▲▼◀▶** to select **[Setup] > [Installation] > [Channel install.] > [Analogue: Manual]**.  
↳ The **[Analogue: Manual]** menu appears.
- 3 Press **▲▼◀▶** to select and enter **[Search]**.
- 4 Press **Numeric buttons** to manually enter the three-digit frequency.
- 5 Press **OK** to begin search.  
↳ If a channel is unavailable at the selected frequency, the system searches for the next available channel.
- 6 Press **↵ BACK** when the new channel is found.
- 7 Press **▲▼** to select **[Store new channel]** to store the new channel under a new channel number.

- 8 Press **▶** to enter [**Store new channel**].
- 9 Press **OK** to store the new channel.
- 10 Press **⬆** (**Home**) to exit.

---

## Rename channels

You can rename channels. The name appears when you select the channel.

- 1 When watching TV, press **OK** to display the channel grid.
- 2 Select the channel you want to rename.
- 3 Press **⏻** **OPTIONS**.  
↳ The channel options menu appears.
- 4 Press **▲▼◀▶** to select and enter [**Rename chan.**].  
↳ A text input box appears.
- 5 Press **▲▼◀▶** to select characters.
- 6 Press **OK** to confirm each of the characters.



Tip

- Rename channels - a channel name can be up to six characters long.
- Press [**Aa**] to change an uppercase letter to a lowercase letter and vice versa.

---

## Reorder channels

After you install channels, you can rearrange the order in which they appear.

- 1 When watching TV, press **⏻** **BROWSE** repeatedly until the channel grid is displayed.
- 2 Press **⏻** **OPTIONS**.  
↳ The channel options menu appears.
- 3 Press **▲▼◀▶** to select and enter [**Reorder**].
- 4 Select the channel you want to reorder and press **OK**.  
↳ The selected channel is highlighted by a yellow border:

- 5 Press **▲▼◀▶** to select the new position for the channel.  
↳ The new position is highlighted by a blue border.
- 6 Press **OK** to confirm the new position.
- 7 Press **⏻** **OPTIONS**.  
↳ [**Done reordering**] appears.
- 8 Press **OK** to finish reordering.

# 7 Connect devices

This section describes how to connect various devices with different connectors and supplements examples provided in the Quick Start.

## Note

- Different types of connectors may be used to connect a device to your TV, depending on availability and your needs. A comprehensive interactive guide to help you connect your product is available at [www.connectivityguide.philips.com](http://www.connectivityguide.philips.com).

## Back connectors

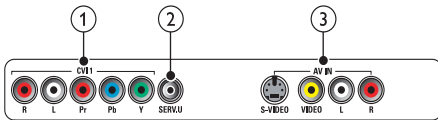

- ① **CVI 2 (Y Pb Pr and AUDIO L/R)**  
Analogue audio and video input from analogue or digital devices such as DVD players or game consoles.
- ② **SERV. U**  
For use by service personnel only.
- ③ **AV IN (S-VIDEO, VIDEO, and AUDIO L/R)**  
Video input for analogue devices such as DVD, camcorder, game console etc. To be used with audio input.

## Bottom connectors

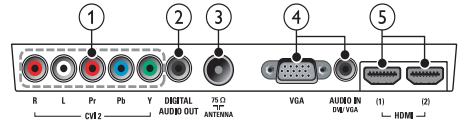

- ① **CVI 1 (Y Pb Pr and AUDIO L/R)**  
Analogue audio and video input from analogue or digital devices such as DVD players or game consoles.
- ② **DIGITAL AUDIO OUT**  
Digital audio output to home theatres and other digital audio systems.
- ③ **ANTENNA**  
Signal input from an antenna, cable or satellite.
- ④ **VGA and AUDIO IN**  
Audio and video input from a computer.
- ⑤ **HDMI**  
Digital audio and video input from high-definition digital devices such as Blu-ray players.

## Side connectors

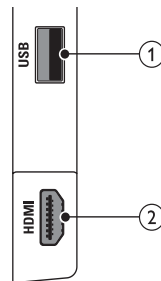



- ① **USB**  
Data input from USB storage devices.
- ② **HDMI**  
Digital audio and video input from high-definition digital devices such as Blu-ray players.

## Connect a computer

- Before you connect a computer to the TV, set the monitor refresh rate on your computer to 60Hz.
- Connect your computer to the TV.
- Press **[FORMAT]** and change the TV picture format to **[Unscaled]**.

Connect a computer with one of the following connectors:

### Note

- Connections via DVI or VGA require an additional audio cable.
- **HDMI cable**

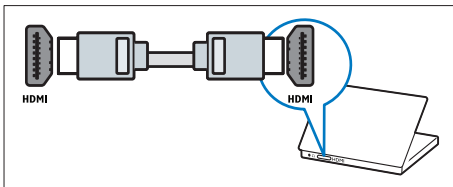

- **DVI-HDMI cable**

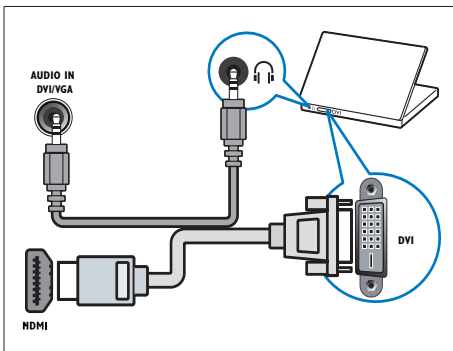

- **HDMI cable and HDMI-DVI adaptor**

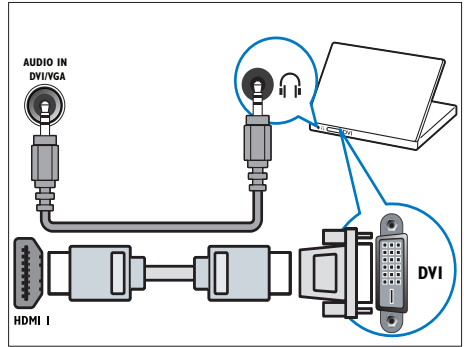

- **VGA cable**

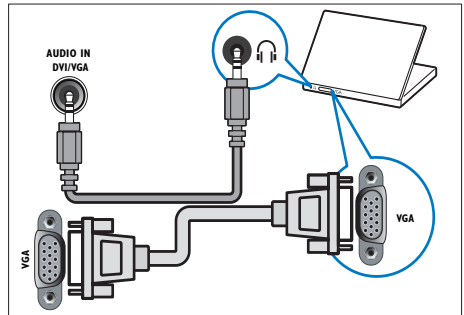

## Add devices

After connecting devices, assign the device attached to each connector. This allows you to easily identify devices connected to your TV.

- 1 Press **[Home]**.
- 2 Select **[Add new device]** and press **OK**.
- 3 Select **[Start]** and press **OK**.
- 4 Press **▲** or **▼** to select a device and press **▶**.
- 5 Press **▲** or **▼** to select the connector your device is connected to and press **▶**.
- 6 If available, press **▲** or **▼** to select the audio connector your device is connected to and press **▶**.

- 7** Switch on your device and check for video and audio output.
- 8** If there is video and audio output, press **OK**.

Repeat the procedure until all devices are correctly assigned to connectors.

---

## Use Philips EasyLink

Your TV supports Philips EasyLink, which uses the HDMI CEC (Consumer Electronics Control) protocol. EasyLink-compliant devices that are connected through HDMI connectors can be controlled by a single remote control.

### Note

- Philips does not guarantee 100% interoperability with all HDMI CEC devices.

### Note

- The EasyLink-compliant device must be switched on and selected as the source.

---

## EasyLink features

### One-touch play

When you connect your product to devices that support one-touch play, you can control your product and the devices with one remote control. For example, when you press Play on your DVD remote control, your TV automatically switches to the correct channel to show the DVD content.

### One-touch standby

When you connect your TV to devices that support standby, you can use your TV remote

control to put your TV and all connected HDMI devices in standby mode.

### System audio control

When you connect your TV to HDMI CEC compliant devices, your TV can switch automatically to play audio from the connected device.

To use one-touch audio, you must map the audio input from the connected device to your TV.

You can use the remote control from the connected device to adjust the volume.

### Remote control (RC) key forwarding

RC key forwarding allows you to control EasyLink-compliant devices using your TV remote control.

---

## EasyLink buttons

You can control EasyLink-compliant devices with the following buttons on the remote control of your TV.

Button	EasyLink function
<b>▶   (Play/Pause)</b>	Starts, pauses or resumes playback on your EasyLink device.
<b>■ (Stop)</b>	Stops playback on your EasyLink device.
<b>● (Record)</b>	Starts or stops video recording on your EasyLink device.
<b>◀◀ (Fast Backward)</b>	Searches backward.
<b>▶▶ (Fast Forward)</b>	Searches forward.
<b>0-9 (Numeric buttons)</b>	When EasyLink is enabled, selects a title, chapter or track.
<b>▲▼◀▶</b>	Navigates through the menus of the EasyLink-compliant device.
<b>OK</b>	Activates a selection or accesses the menu of the EasyLink-compliant device.
<b>☰ (OPTIONS)</b>	Displays the menus of the EasyLink-compliant device. Press <b>🏠 (Home)</b> to display the TV menu.
<b>⏻ (Standby-On)</b>	When EasyLink is enabled, switches the TV and all EasyLink devices to standby. Press and hold <b>⏻ (Standby-On)</b> for at least 3 seconds.



Tip

- Press **TV** to switch back to the aerial source from EasyLink mode.

## Enable or disable EasyLink



Note

- Do not enable Philips EasyLink if you do not intend to use it.

- 1 Press **🏠 (Home)**.
- 2 Select **[Installation] > [Preferences] > [EasyLink]**.

- 3 Select **[ON]** or **[OFF]**.

## Enable or disable remote control key forwarding

- 1 Press **☰ (OPTIONS)**.
- 2 Select **[En./Dis. RC pass.]**.
- 3 Press **OK**.
- 4 Press **▲** or **▼** to highlight an HDMI connector.
- 5 Press **OK** to enable RC key forwarding for the selected HDMI connector.

## Set TV speakers to EasyLink mode

When you play content from an EasyLink compliant home theater, the TV speakers are automatically muted.

- 1 Press **🏠 (Home)**.
- 2 Press **▲▼◀▶** to select **[Setup] > [Sound]**.  
↳ The **[Sound]** menu appears.
- 3 Select **[TV speakers]**.  
↳ The **[TV speakers]** menu appears.
- 4 Select **[Auto (EasyLink)]**.  
↳ TV speakers are set to EasyLink mode.

---

## Use a Kensington lock

There is a Kensington security slot at the bottom of the TV. Prevent theft by looping a Kensington lock between the slot and a permanent object, such as a heavy table.

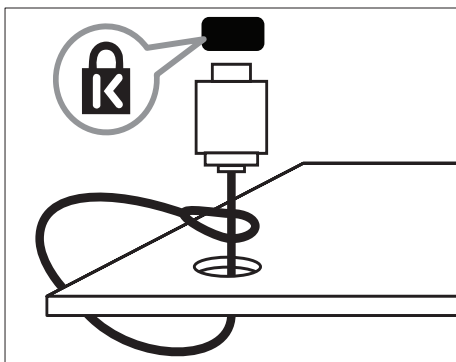

# 8 Product information

Product information is subject to change without notice. For detailed product information, go to [www.philips.com/support](http://www.philips.com/support).

## Supported display resolutions

### Computer formats (HDMI/VGA)

Resolution	Refresh rate (Hz)
640 × 480	60
800 × 600	60
1024 × 768	60
1280 × 1024	60
1360 × 768	60
1920 × 1080	60

### Video formats (HDMI/YPbPr)

Resolution	Refresh rate (Hz)
720 × 480i	60
720 × 576i	50
720 × 480p	60
720 × 576p	50
1280 × 720p	50, 60
1920 × 1080i	50, 60
1920 × 1080p	24, 25, 30, 50, 60

## Tuner/Reception/Transmission

- Antenna input: 75ohm coaxial (IEC75)
- TV system: PAL
- Video playback: NTSC, PAL

## Multimedia

- Connection: USB
- Playback formats: MP4, JPEG, JPG, MP3

### Video playback via USB:

Container	Video codec	Audio codec	File extension
Mpeg1	Mpeg-1	Mpeg audio	.dat .mpg
Mpeg4	Mpeg-4	AAC	.avi .mp4
RealMedia	Real Media	AAC, Cook	.rm .rmvb
	8/9/10		

## Remote control

- Batteries: 2 × AAA (R03 type)

## Power

- Mains power: AC 220-240 (50-60Hz)
- Standby power: < 0.15W
- Ambient temperature: 5 to 40 degrees Celsius

## Supported TV mounts

To mount the TV, purchase a Philips TV mount. To prevent damage to cables and connectors, be sure to leave a clearance of at least 2.2 inches or 5.5cm from the back of the TV.



### Warning

- Follow all instructions provided with the TV mount. Koninklijke Philips Electronics N.V. bears no responsibility for improper TV mounting that results in accident, injury or damage.

TV screen size	Wall bracket type	Screw size
32" - 40"	200 x 200 mm	M6
46" - 52"	300 x 300 mm	M8

## Product specification

Design and specifications are subject to change without notice.

### 32PFL5605

- Without TV stand
  - Dimension (WxHxD): 790 x 501 x 92 (mm)
  - Weight: 10 kg
- With TV stand
  - Dimension (WxHxD): 790 x 542 x 221 (mm)
  - Weight: 11.5 kg

### 40PFL5605

- Without TV stand
  - Dimension (WxHxD): 977 x 605 x 86 (mm)
  - Weight: 13.7 kg
- With TV stand
  - Dimension (WxHxD): 977 x 649 x 236 (mm)
  - Weight: 16.1 kg

### 46PFL5605

- Without TV stand
  - Dimension (WxHxD): 1122 x 685 x 87 (mm)
  - Weight: 17.9 kg
- With TV stand
  - Dimension (WxHxD): 1122 x 731 x 268 (mm)
  - Weight: 21.3 kg



#### Note

- Design and specifications are subject to change without notice.

# 9 Troubleshooting

This section describes commonly encountered issues and accompanying solutions.

---

## General TV issues

### The TV does not switch on:

- Disconnect the power cable from the power outlet. Wait for one minute then reconnect it.
- Check that the power cable is securely connected.

### The remote control is not working properly:

- Check that the remote control batteries are correctly inserted according to the +/- orientation.
- Replace the remote control batteries if they are flat or weak.
- Clean the remote control and TV sensor lens.

### The standby light on the TV blinks red:

- Disconnect the power cable from the power outlet. Wait until the TV cools down before reconnecting the power cable. If the blinking reoccurs, contact Philips Consumer Care.

### You forgot the code to unlock the child lock feature

- Enter '8888'.

### The TV menu is in the wrong language.

- Change the TV menu to your preferred language.

### When turning the TV on/off/to standby, you hear a creaking sound from the TV chassis:

- No action is required. The creaking sound is normal expansion and contraction of the TV as it cools down and warms up. This does not impact performance.

---

## TV channel issues

### Previously installed channels do not appear in the channel list:

- Check that the correct channel list is selected.

---

## Picture issues

### The TV is on, but there is no picture:

- Check that the antenna is properly connected to the TV.
- Check that the correct device is selected as the TV source.

### There is sound but no picture:

- Check that the picture settings are correctly set.

### There is poor TV reception from an antenna connection:

- Check that the antenna is properly connected to the TV.
- Loudspeakers, unearthed audio devices, neon lights, high buildings and other large objects can influence reception quality. If possible, try to improve the reception quality by changing the antenna direction or moving devices away from the TV.
- If reception on only one channel is poor, fine tune this channel.

### There is poor picture quality from connected devices:

- Check that the devices are connected properly.
- Check that the picture settings are correctly set.

### The TV did not save your picture settings:

- Check that the TV location is set to the home setting. This mode offers you the flexibility to change and save settings.

### The picture does not fit the screen; it is too big or too small:

- Try using a different picture format.

**The picture position is incorrect:**

- Picture signals from some devices may not fit the screen correctly. Check the signal output of the device.

---

## Sound issues

**There is a picture but sound quality is poor:** **Note**

- If no audio signal is detected, the TV automatically switches the audio output off — this does not indicate malfunction.
- Check that all cables are properly connected.
- Check that the volume is not set to 0.
- Check that the sound is not muted.

**There is a picture but the sound quality is poor:**

- Check that the sound settings are correctly set.

**There is a picture but sound comes from one speaker only:**

- Verify that sound balance is set to the centre.

---

## HDMI connection issues

**There are problems with HDMI devices:**

- Note that HDCP (High-bandwidth Digital Content Protection) support can delay the time taken for a TV to display content from a HDMI device.
- If the TV does not recognize the HDMI device and no picture is displayed, try switching the source from one device to another and back again.
- If there are intermittent sound disruptions, check that output settings from the HDMI device are correct.
- If you use an HDMI-to-DVI adapter or HDMI to DVI cable, check that an additional audio cable is connected to

AUDIO L/R or AUDIO IN (mini-jack only).

---

## Computer connection issues

**The computer display on the TV is not stable:**

- Check that your PC uses the supported resolution and refresh rate.
- Set the TV picture format to unscaled.

---

## Contact us

If you cannot resolve your problem, refer to the FAQs for this TV at [www.philips.com/support](http://www.philips.com/support).

If the problem remains unresolved, contact Philips Consumer Care in your country as listed in this user manual.

**Warning**

- Do not attempt to repair the TV yourself. This may cause severe injury, irreparable damage to your TV or void your warranty.

**Note**

- Make a note of your TV model and serial number before you contact Philips. These numbers are printed on the back of the TV and on the packaging.



# 10 Index

---

<b>A</b>	
antenna	23
<hr/>	
<b>B</b>	
back connectors	23
batteries	28, 4, 30
bracket for wall mount	28
<hr/>	
<b>C</b>	
care	4
channels	
install	
automatic	21
manual	21
lock	15
rename	22
reorder/rearrange	22
switch	8
troubleshooting	30
tune	21
child lock	
lock channels	15
lock connected devices	15
PIN code	30, 15
computer	
connect	31
display resolution	28
connect	
antenna	23
PC	31
power cord	23
connectors	
back connectors	23
HDMI	31, 23
overview	23
side connectors	23
USB	16
controls	5
<hr/>	
<b>D</b>	
default settings	19
demo	19
devices	23
devices	
add to home menu	10, 24
remove	10
watch	8
digital services	
teletext	9, 13
disconnect USB	16
display	
resolution	28
wallpaper	18
dispose	4
<hr/>	
<b>E</b>	
EasyLink	
disable	26
enable	26
system audio control	26
end of life	4
environmental care	4
e-sticker	19
<hr/>	
<b>F</b>	
factory settings	19
<hr/>	
<b>H</b>	
HDMI	31, 23, 23
home mode	19
<hr/>	
<b>I</b>	
install channels	
automatic	21
manual	21
<hr/>	
<b>K</b>	
Kensington lock	27

---

<b>L</b>	
language	
menu	30
troubleshoot	30
list	
location	
home or shop	19
lock	
Kensington lock	27
lock channels	15
lock connected devices	15
PIN code	30, 15

---

<b>M</b>	
menu	
language	30
main menu	10, 10
teletext	13
troubleshooting	30
MHEG teletext	9
MPEG artifact reduction	11
multimedia	28
music	
USB	17
with slideshow	17
mute TV speakers	26

---

<b>O</b>	
on timer	14, 14

---

<b>P</b>	
PC	
connect	31
resolution	28
picture format	
change	11
troubleshooting	30
picture settings	10
PIN code	30, 15
pixel plus link	19
power	28, 30, 5
power consumption	28
preferences	19
product specifications	28

---

<b>R</b>	
rearrange channels	22
reception	30
recycle	4
register product	5
remote control	
batteries	28, 4
overview	5
RC pass-through	26
technical specifications	28
troubleshooting	30
rename channels	22
reorder channels	22
resolution	28
restore default	19

---

<b>S</b>	
safety	3
screen care	4
screen saver	18
settings	
picture	10, 11
sound	12, 10
settings assistant	10
shop mode	19
side connectors	23
side controls	5
slideshow	
view	16
with music	17
smart picture	11
smart settings	11, 12
smart sound	12
software	
update	19
version	19
sound settings	12, 12
specifications	28
standby	8, 30
subpages in teletext	13
switch	
channels	8
on and off	8
source	8

---

## T

<b>Table of Pages</b>	13
<b>technical specifications</b>	28
<b>teletext</b>	
features	13
menu	13
subpages	13
Table of Pages	13
use	9
<b>timer</b>	
on timer	14, 14
sleep timer	14
standby	14
<b>transmission</b>	28, 30
<b>transporting</b>	3
<b>troubleshooting</b>	30
<b>TV lock</b>	
lock channels	15
lock connected devices	15
PIN code	30, 15
<b>TV overview</b>	5

---

## U

<b>USB</b>	
disconnect USB	16
listen to music	17
upload a picture from	18
view photos	16

---

## V

<b>video format</b>	
technical specifications	28
<b>volume</b>	
adjust	9
automatic levelling	12
delta	12
mute	9, 26

---

## W

<b>wall mount</b>	3
<b>wallpaper</b>	18

