

55PUG8808/78
65PUG8808/78
75PUG8808/78

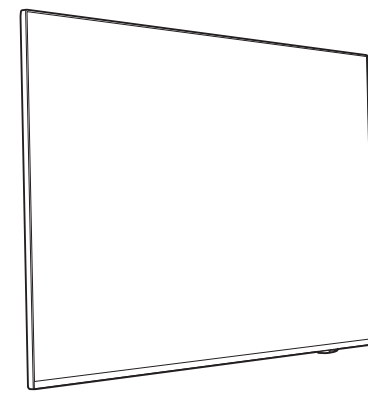

55"/65"

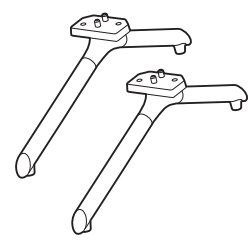

75"

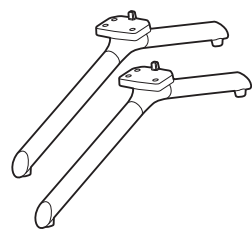

x4
• 55"/65": x4
• 75": x6

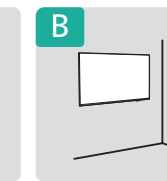
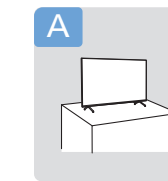
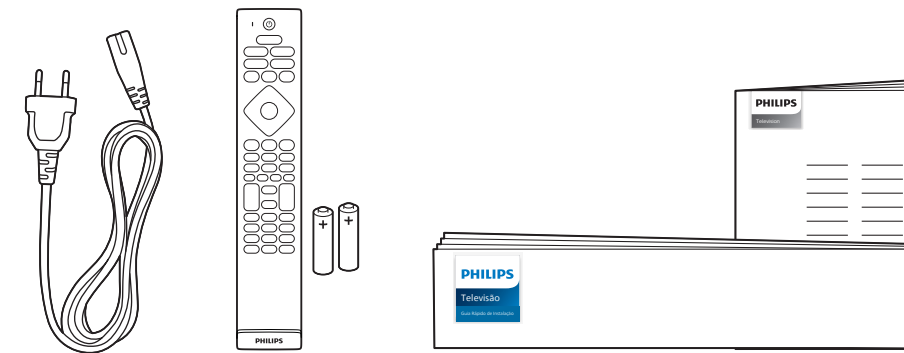

Registre seu produto e obtenha suporte em www.philips.com/TVsupport

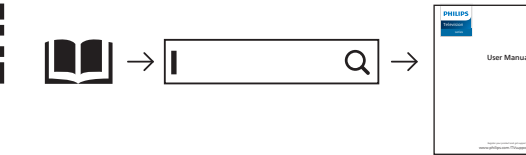

A 1a 55"

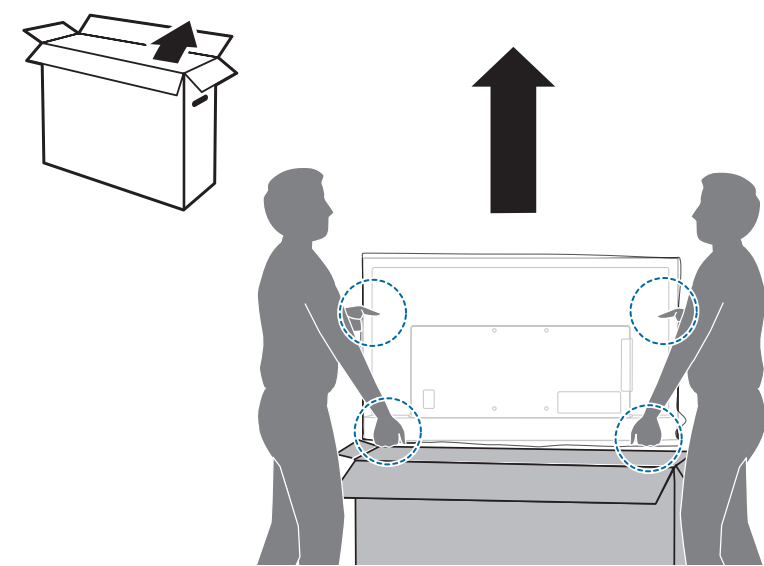

1b 65"/75"

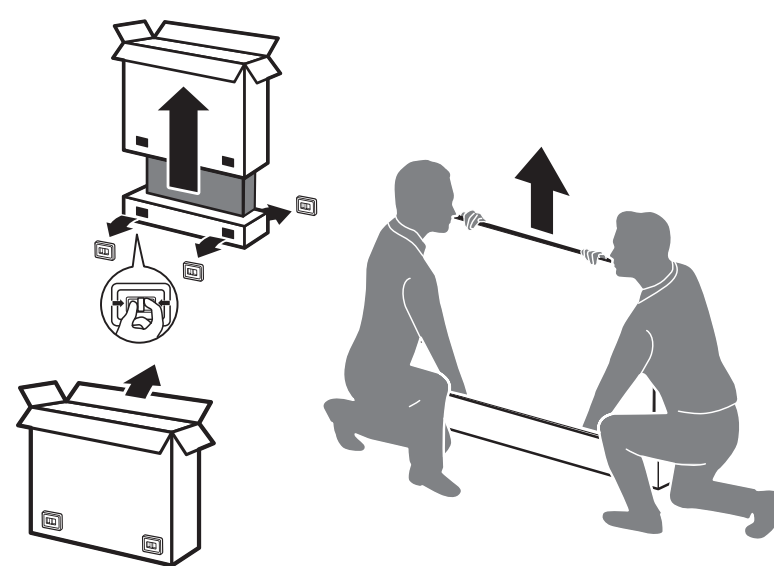

2

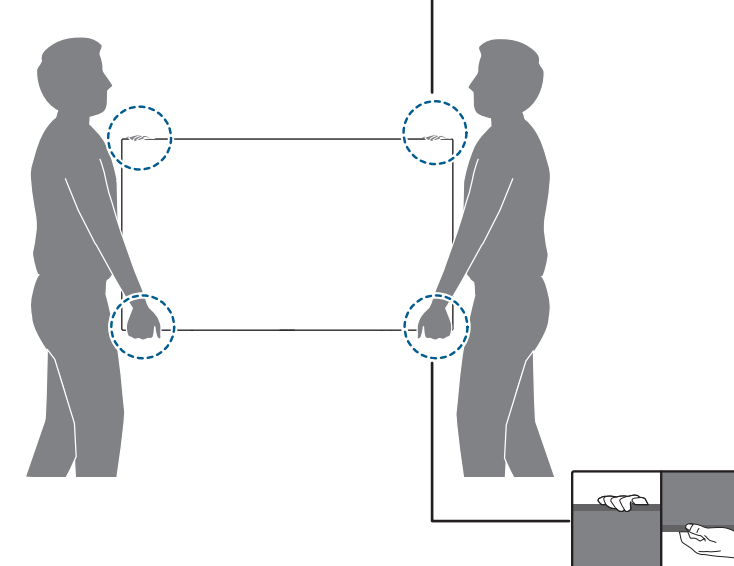

3

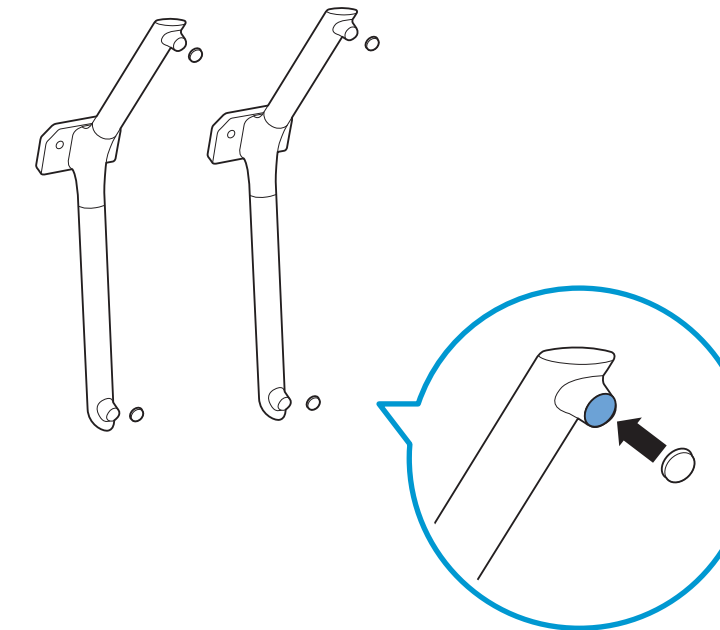

B

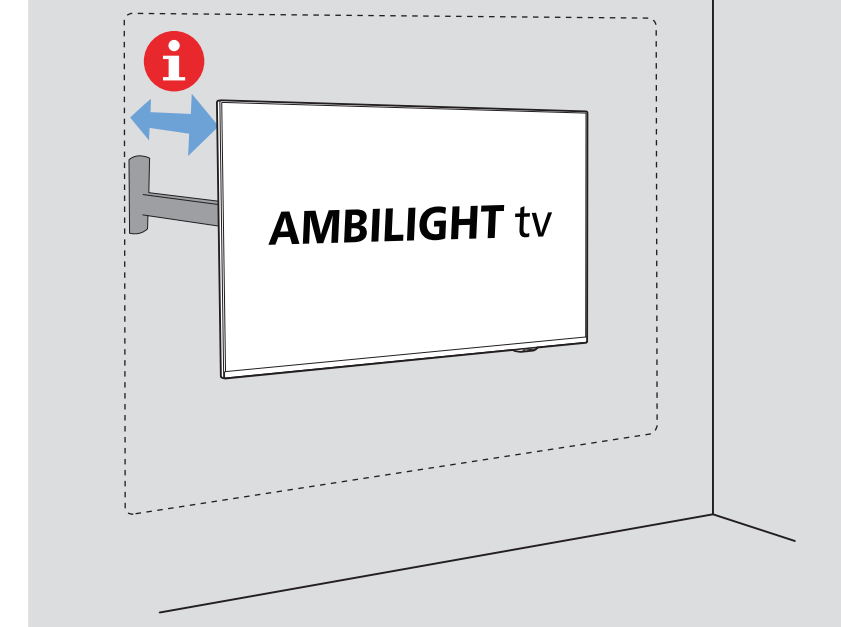

4

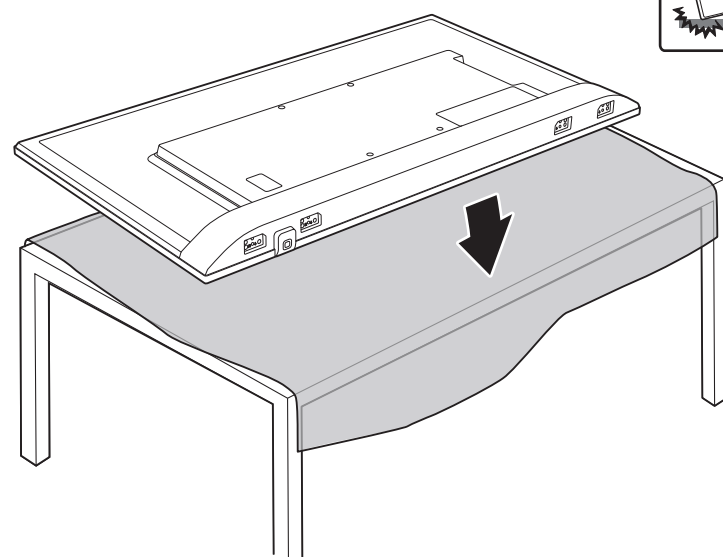

5

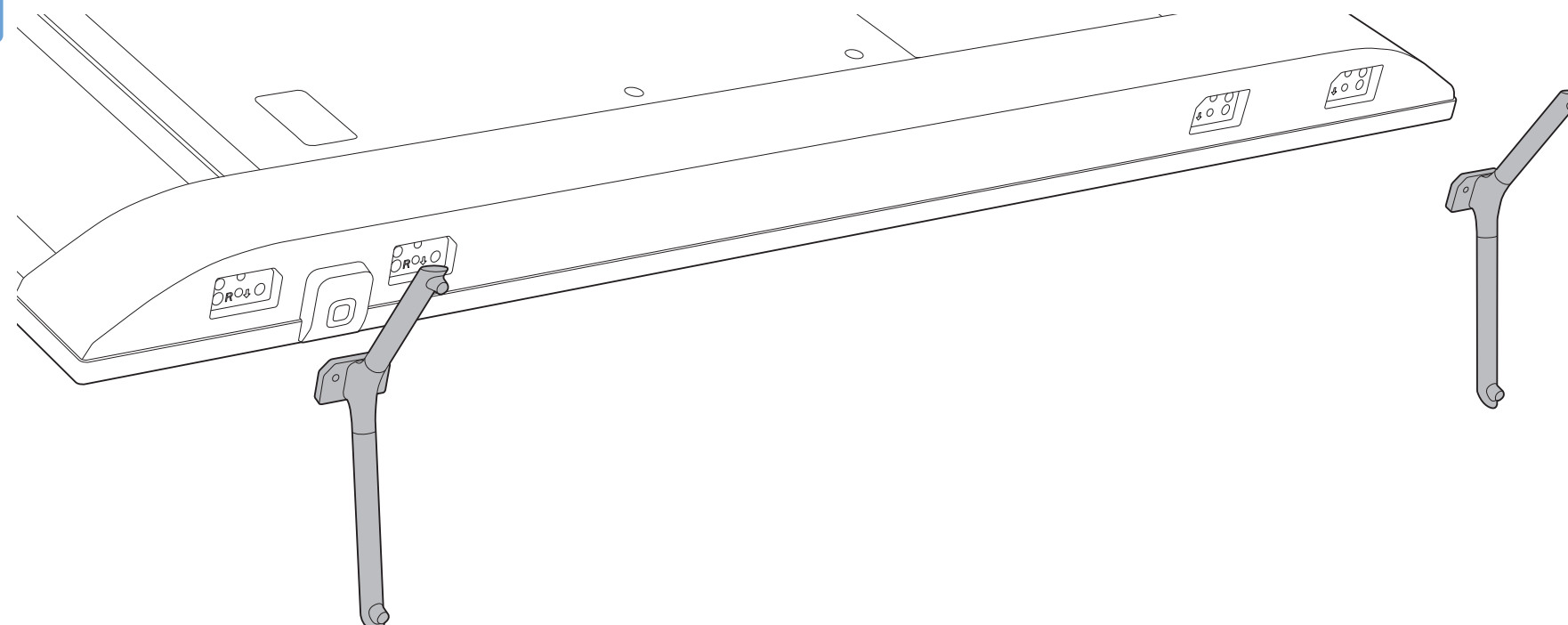

R + L

55"/65"

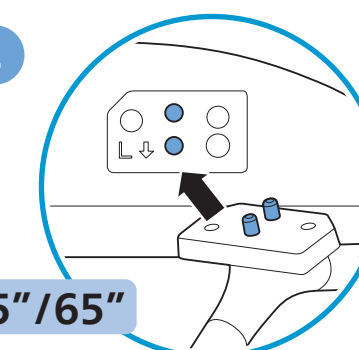

75"

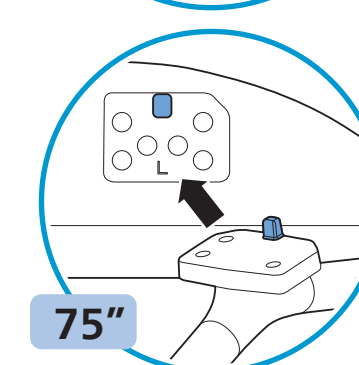

Dimensões para montagem na parede (x, y)

55" 200x300mm M6 (L: 10mm~16mm) 139 cm

65" 300x300mm M6 (L: 12mm~20mm) 164 cm

75" 300x300mm M8 (L: 26mm~39mm) 189 cm

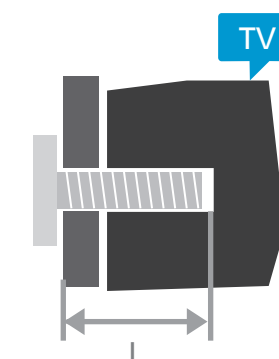

6

R

L



R + L

55"/65"

75"

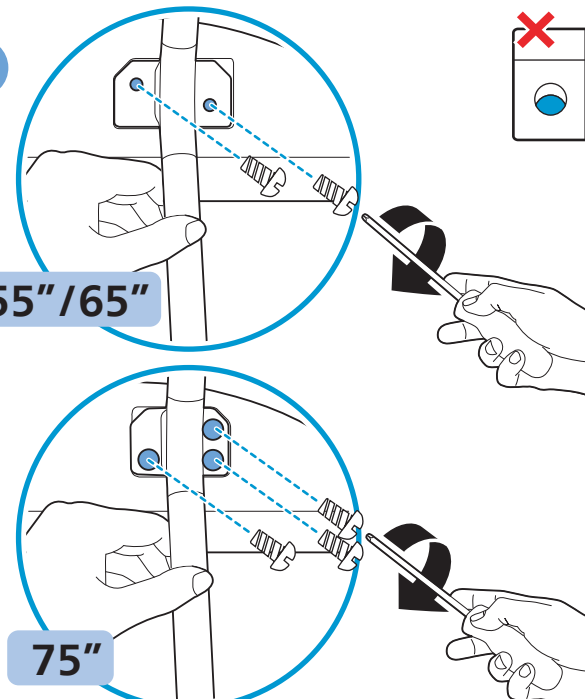

7

i

AMBILIGHT tv

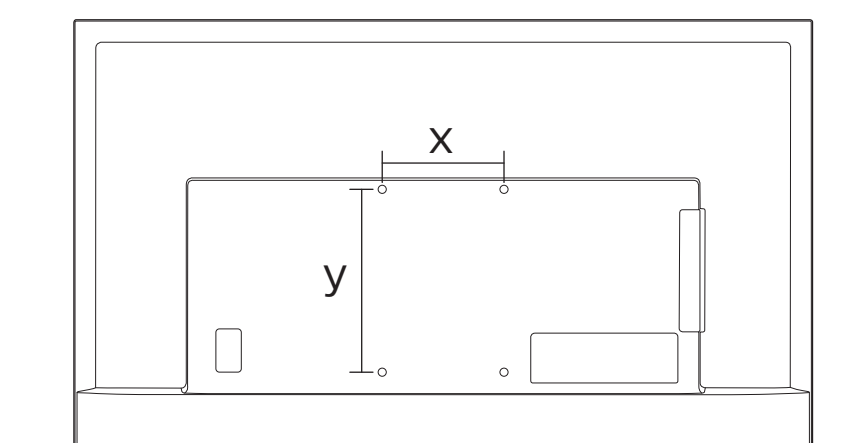
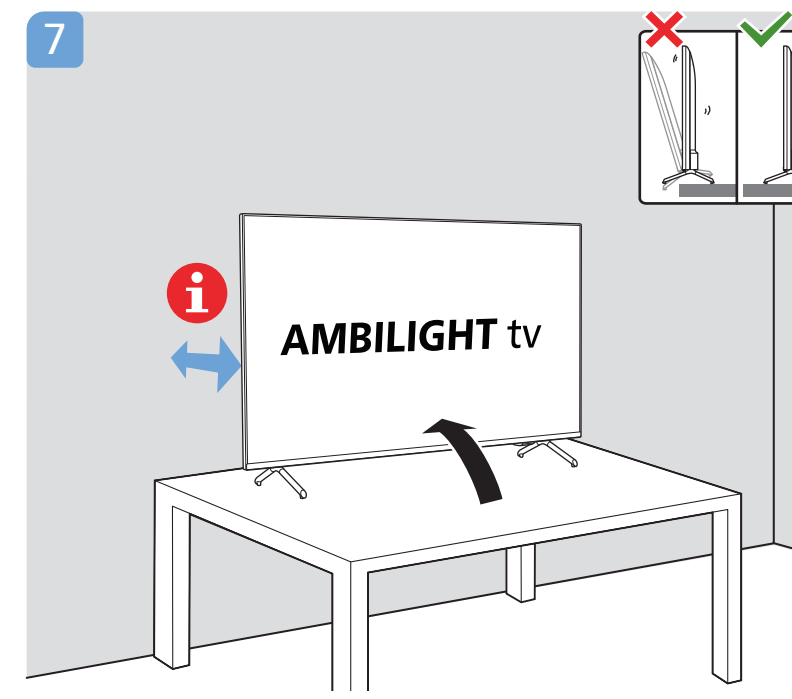

	A	B
55"	100.6	26.7
65"	122.6	30.9
75"	144.9	35.0

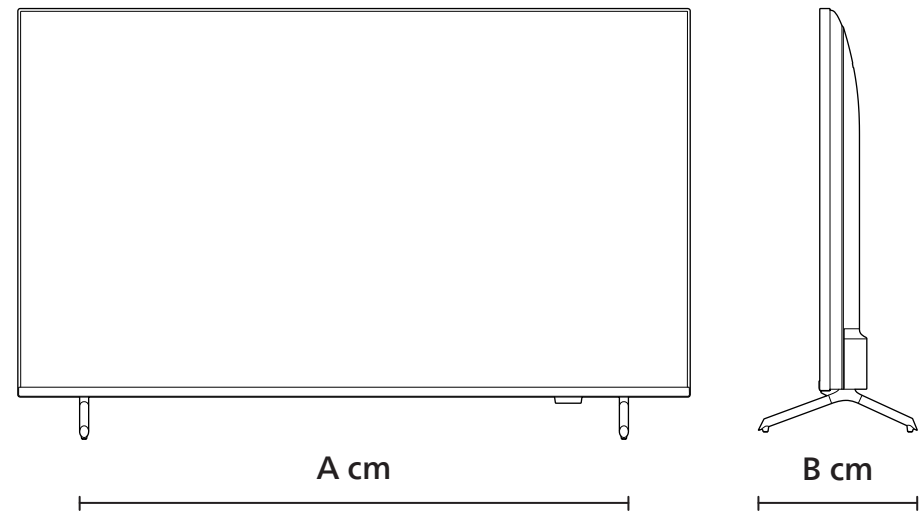

English Read the safety instructions.
Português Leia as instruções de segurança.

PRODUZIDO NO POLO INDUSTRIAL DE MANAUS
CONHEÇA A AMAZÔNIA
IMPRESSO NA CHINA



1. [Image of TV back panel]
2. [Image of TV back panel]
3. [Image of TV back panel with 2x AAA 1.5V batteries being inserted]
4. [Image of TV back panel]
5. [Image of TV back panel with 'Click' label]

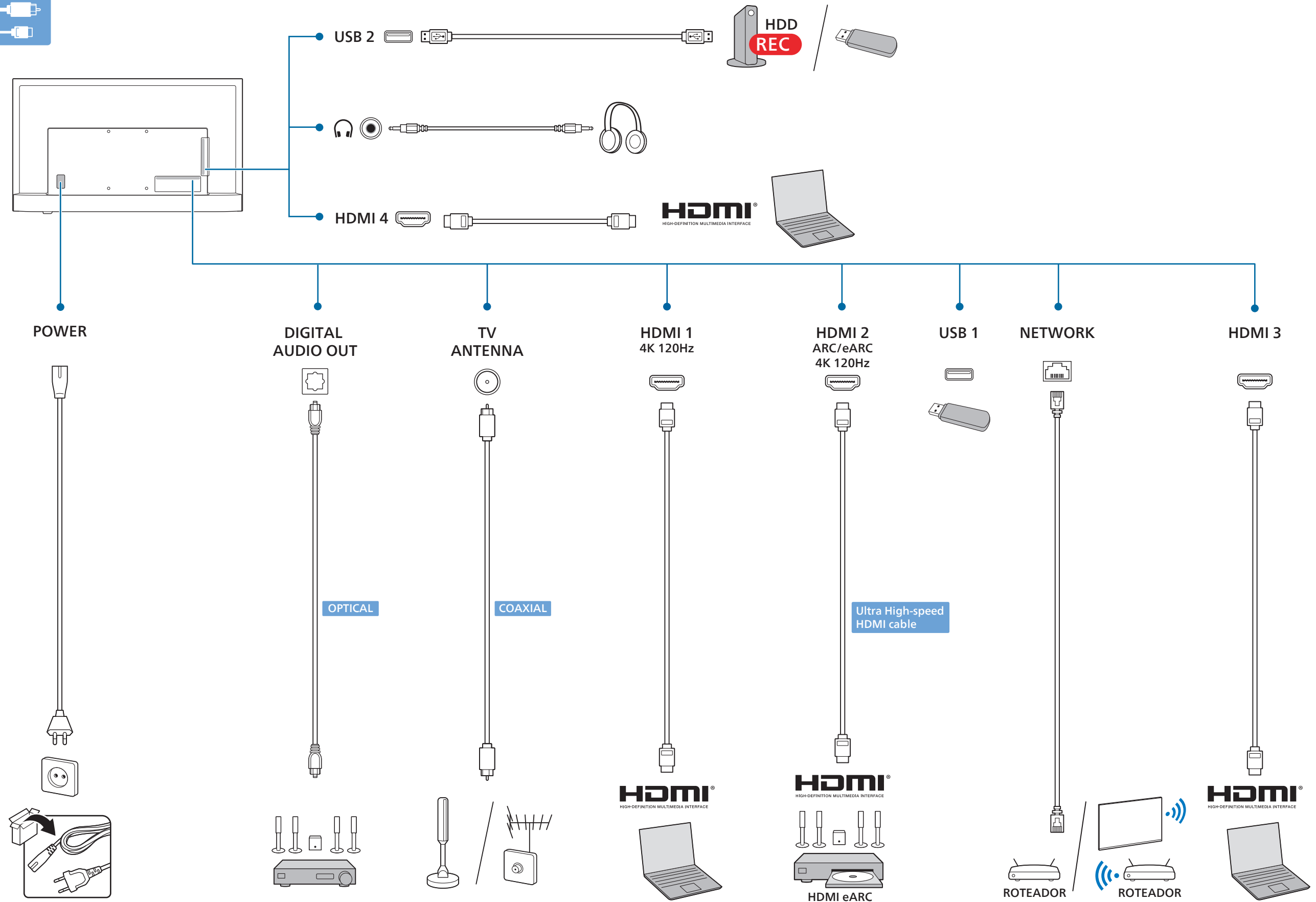
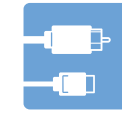
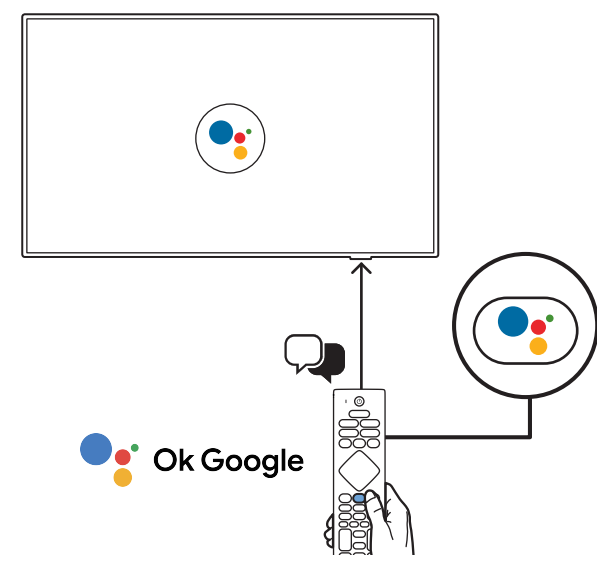
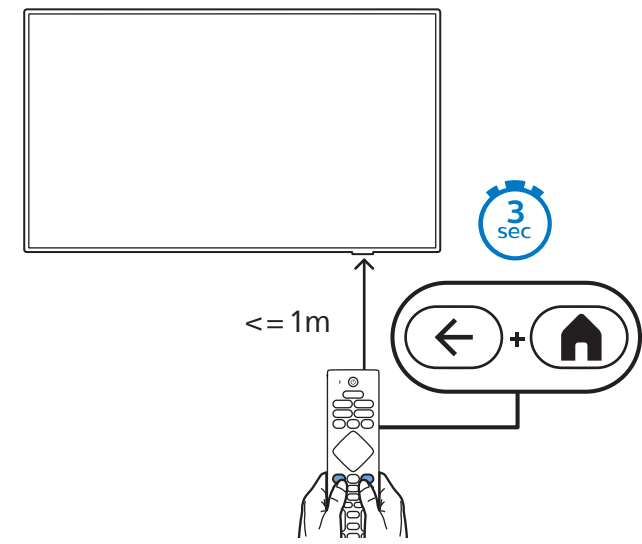

AMBILIGHT tv

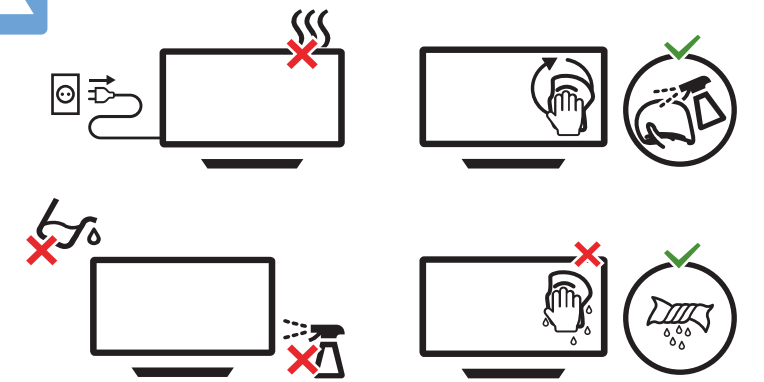
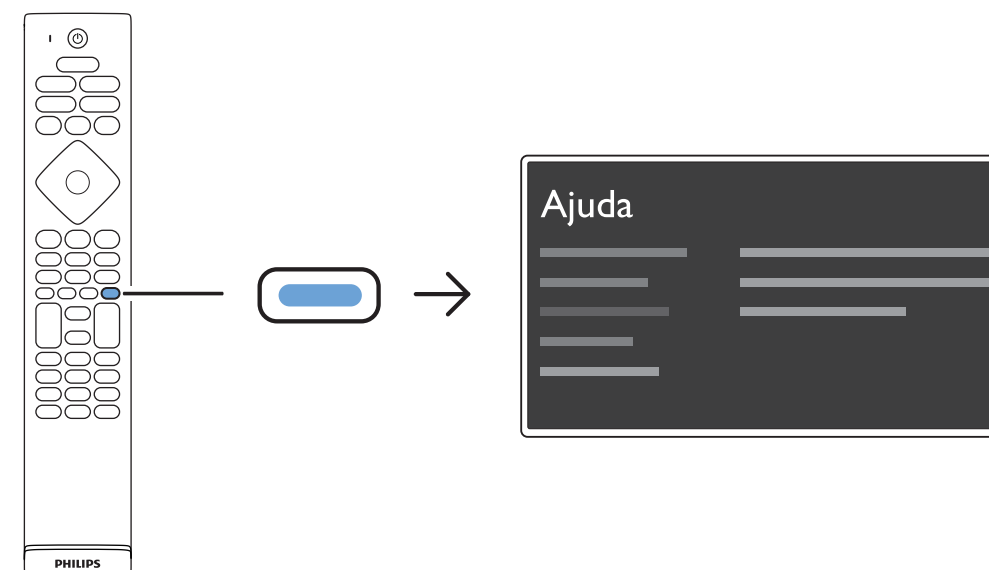
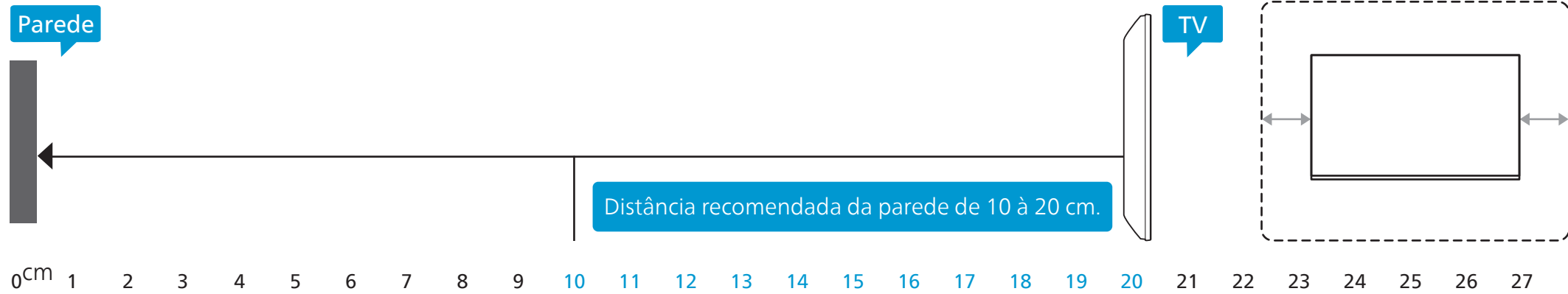

All registered and unregistered trademarks are property of their respective owners. Specifications are subject to change without notice. Philips and the Philips' shield emblem are trademarks of Koninklijke Philips N.V. and are used under license from Koninklijke Philips N.V. This product has been manufactured by and is sold under the responsibility of TP Vision Europe B.V. and TP Vision Europe B.V. is the warrantor in relation to this product. 2023 © TP Vision Europe B.V. All rights reserved. www.philips.com/welcome