

PHILIPS

Televisión

Guía Rápida

32PHD6918/77

43PFD6918/77

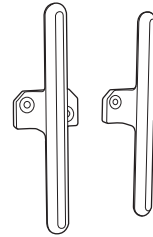
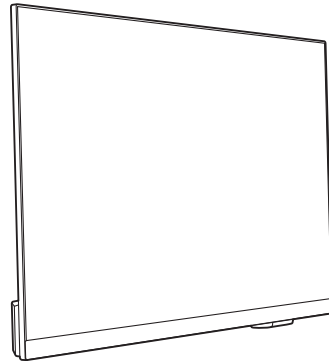

x4

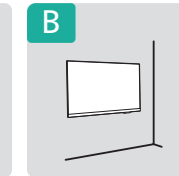
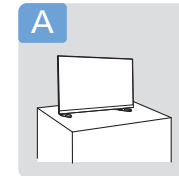
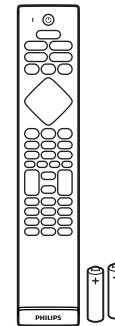
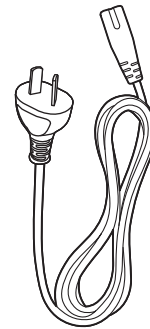

Registre su producto y obtenga asistencia en www.philips.com/TVsupport

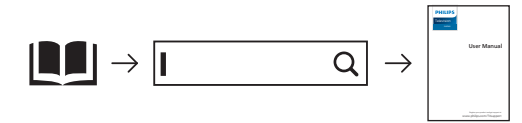

A 32"/43"

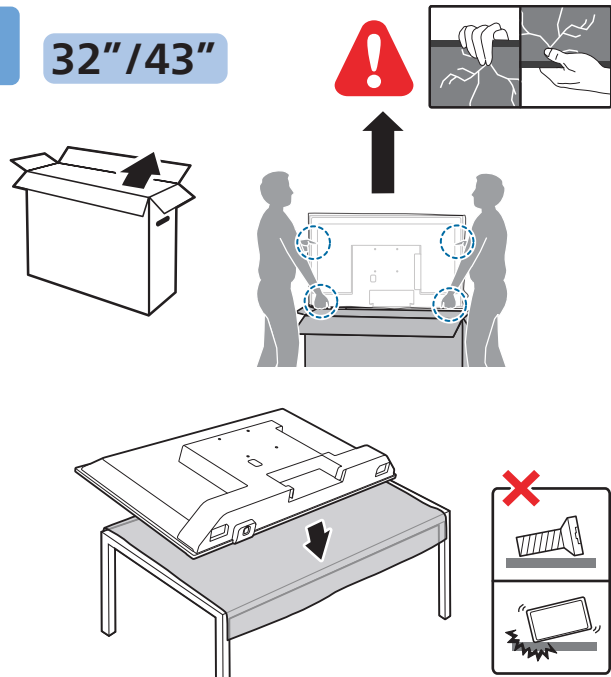

1

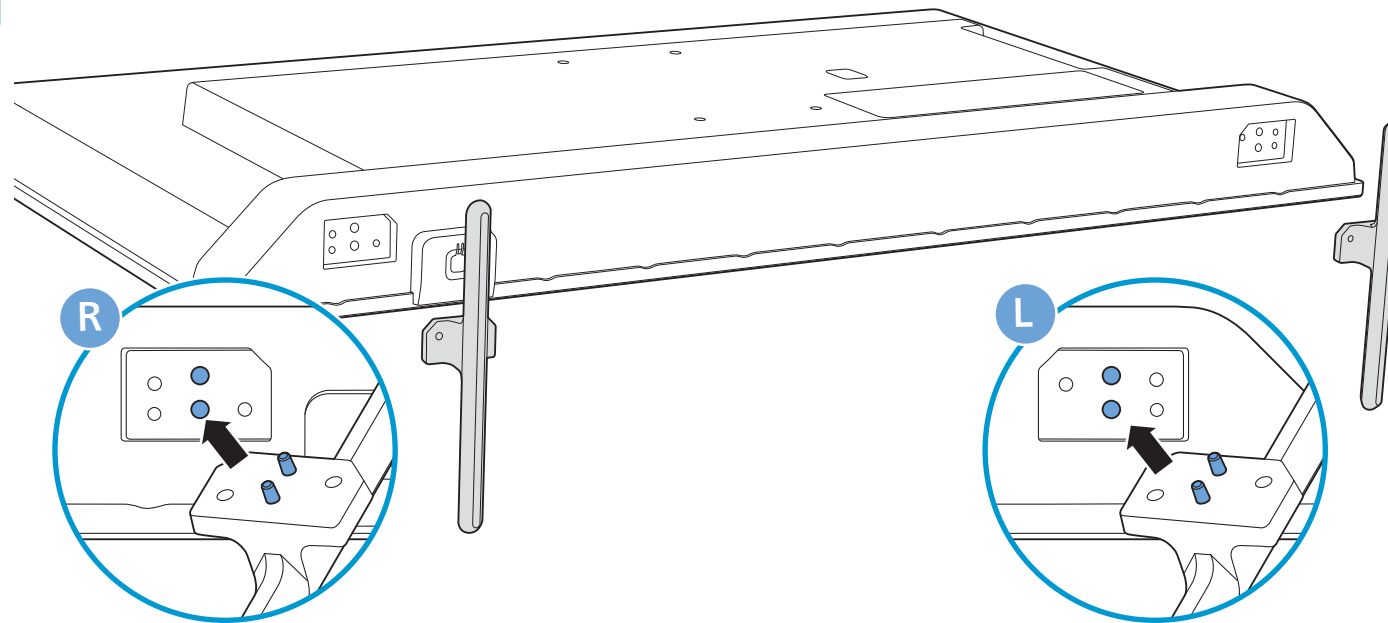

B

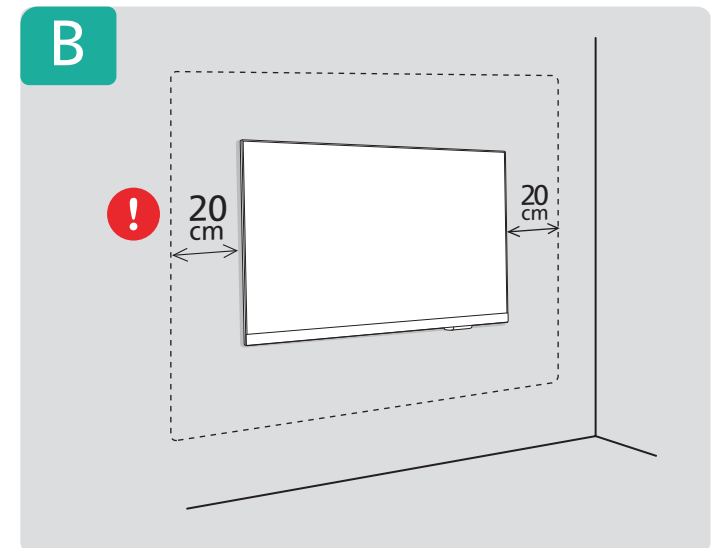

2

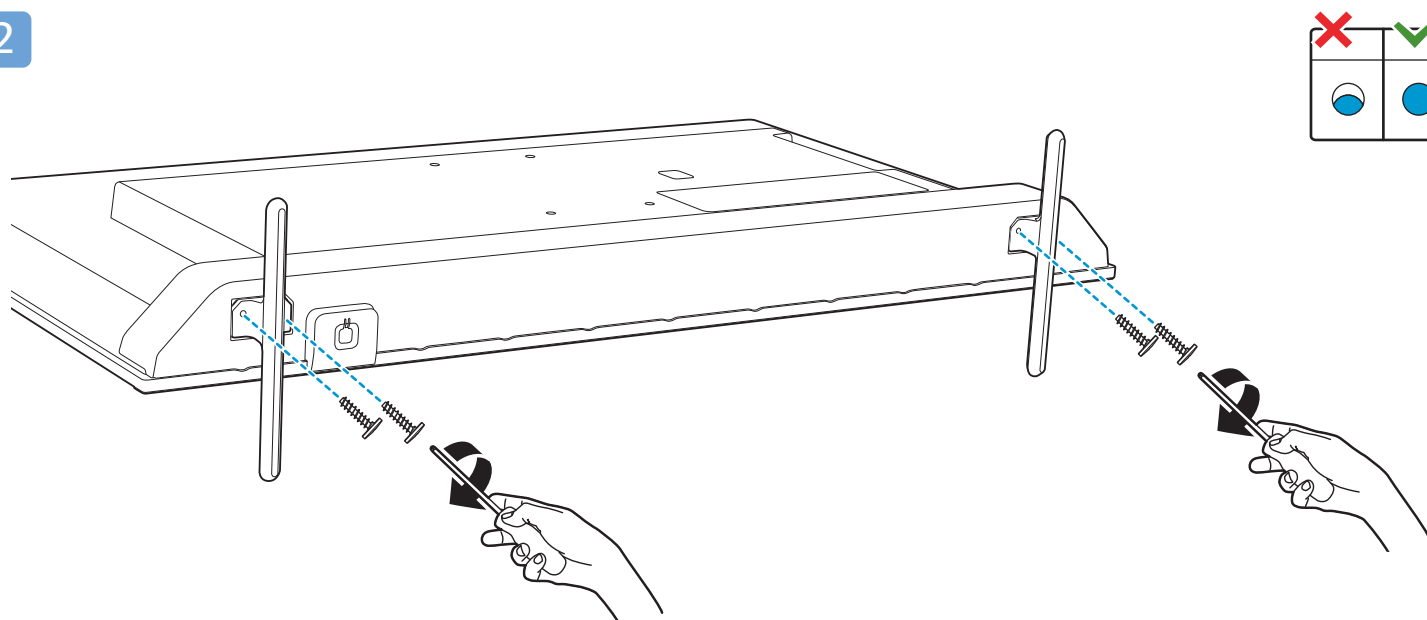

3

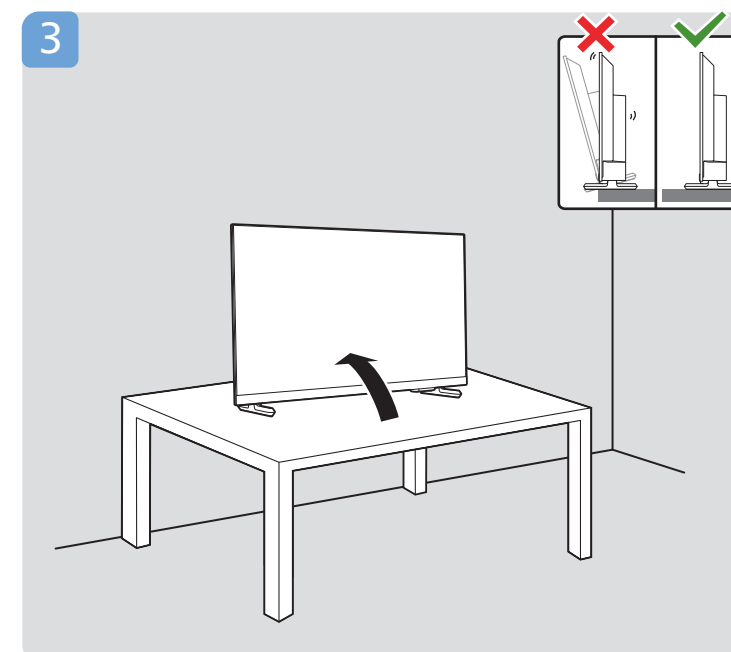

Dimensiones para montaje en pared (x, y)

32" 100x100mm M4 (L: 8mm~10mm)

80 cm

43" 100x200mm M6 (L: 10mm~12mm)

108 cm

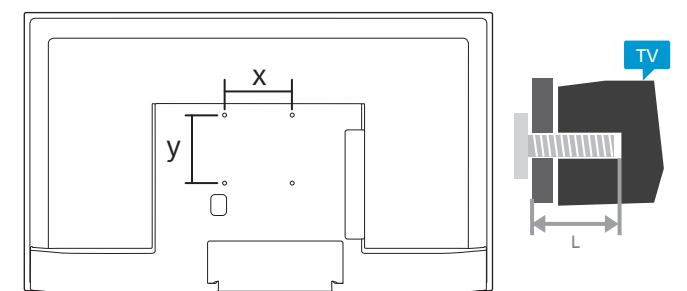



1

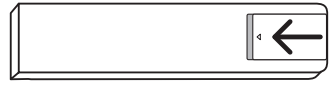

2

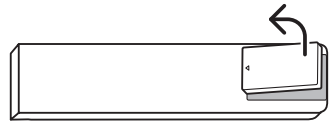

3

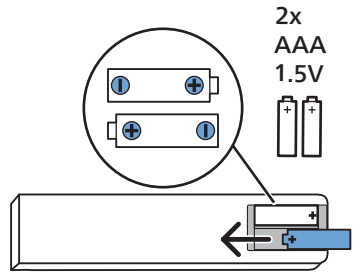

4

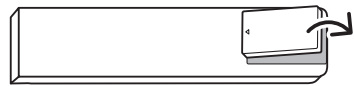

5

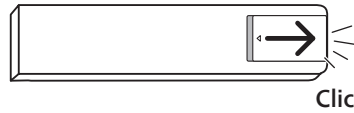

<= 1m

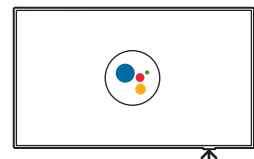
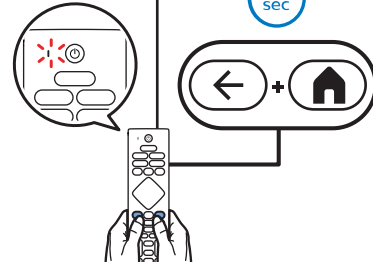

Ok Google

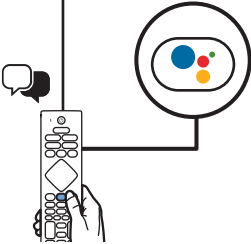

English Read the safety instructions.

Español Lea la información de seguridad.

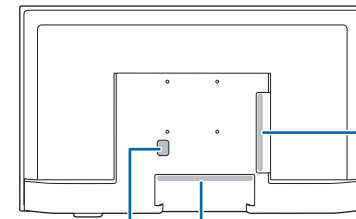
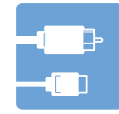

POWER

DIGITAL AUDIO OUT

USB 2

NETWORK

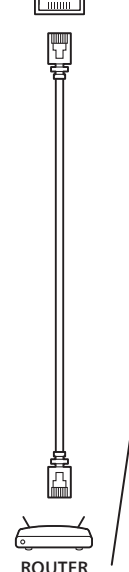
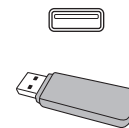
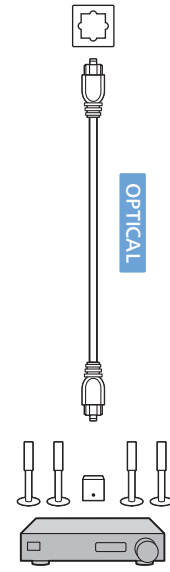
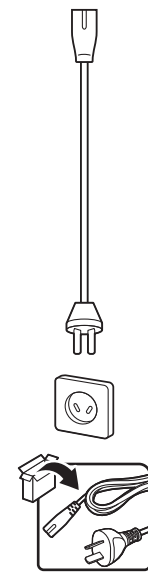

USB 1

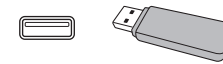

TV ANTENNA

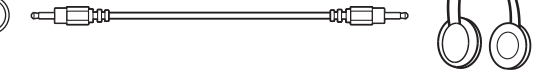

HDMI 1 ARC

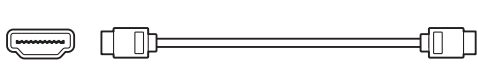

HDMI 2/3

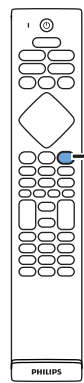
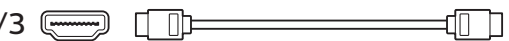

APPS

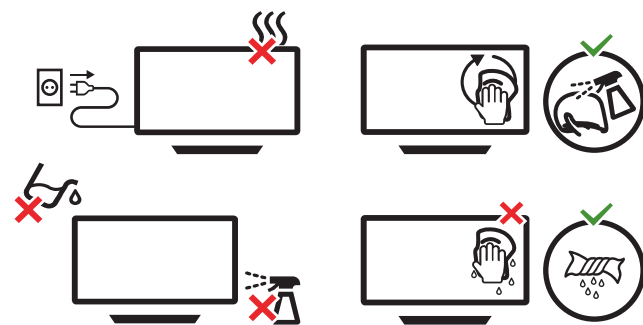
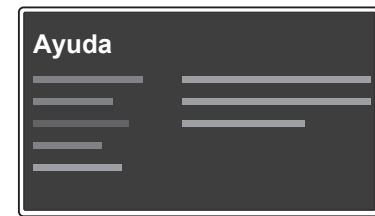

All registered and unregistered trademarks are property of their respective owners. Specifications are subject to change without notice. Philips and the Philips' shield emblem are trademarks of Koninklijke Philips N.V. and are used under license from Koninklijke Philips N.V. This product has been manufactured by and is sold under the responsibility of TP Vision Europe B.V., and TP Vision Europe B.V. is the warrantor in relation to this product. 2023 © TP Vision Europe B.V. All rights reserved. www.philips.com/welcome