

Register your product and get support at
www.philips.com/welcome



22PFL5957/V7

24PFL5957/V7

32PFL5937/V7

32PFL5957/V7

EN

User manual

PHILIPS

Contents

1	Notice	2
---	--------	---

2	Important	3
	Product disposal Guidelines	4

3	Use your TV	5
---	-------------	---

4	Use more of your TV	10
---	---------------------	----

5	Play photos, music and videos on USB storage devices	13
---	---	----

6	Troubleshooting	15
---	-----------------	----

7	Product information	17
---	---------------------	----

8	Consumer Guidelines	19
---	---------------------	----

9	Warranty	20
---	----------	----

1 Notice

Pixel characteristics

This LCD/LED product has a high number of color pixels. Although it has effective pixels of 99.999% or more, black dots or bright points of light (red, green or blue) may appear constantly on the screen. This is a structural property of the display (within common industry standards) and is not a malfunction.

Warranty

No components are user serviceable Do not open or remove covers to the inside of the product. Repairs may only be done by Philips Service Centres and official repair shops. Failure to do shall void any warranty, stated or implied.
Any operation expressly prohibited in this manual, or any adjustments and assembly procedures not recommended or authorised in this manual shall void the warranty.

2 Important

Read and understand all instructions before you use your TV. If damage is caused by failure to follow instructions, the warranty does not apply.

Safety

Risk of electric shock or fire!

- Never expose the TV to rain or water. Never place liquid containers, such as vases, near the TV. If liquids are spilled on or into the TV, disconnect the TV from the power outlet immediately. Contact Philips Consumer Care to have the TV checked before use.
- Never place the TV, remote control or batteries near naked flames or other heat sources, including direct sunlight. To prevent the spread of fire, keep candles or other flames away from the TV, remote control and batteries at all times.



- Never insert objects into the ventilation slots or other openings on the TV.
- When the TV is swivelled ensure that no strain is exerted on the power cord. Strain on the power cord can loosen connections and cause arcing.

Risk of short circuit or fire!

- Never expose the remote control or batteries to rain, water or excessive heat.
- Avoid force coming onto power plugs. Loose power plugs can cause arcing or fire.

Risk of injury or damage to the TV!

- Two people are required to lift and carry a TV that weighs more than 25 kg or 55 lbs.
- When stand mounting the TV, use only the supplied stand. Secure the stand to the TV tightly. Place the TV on a flat, level surface that can support the combined weight of the TV and the stand.
- When wall mounting the TV, use only a wall mount that can support the weight of the TV. Secure the wall mount to a wall that can support the combined weight of the TV and wall mount. PE Electronics Ltd. bears no responsibility for improper wall mounting that result in accident, injury or damage.

Risk of injury to children!

Follow these precautions to prevent the TV from toppling over and causing injury to children:

- Never place the TV on a surface covered by a cloth or other material that can be pulled away.
- Ensure that no part of the TV hangs over the edge of the surface.
- Never place the TV on tall furniture (such as a bookcase) without anchoring both the furniture and TV to the wall or a suitable support.
- Educate children about the dangers of climbing on furniture to reach the TV.

Risk of swallowing batteries!

- The product/remote control may contain a coin-type battery, which can be swallowed. Keep the battery out of reach of children at all times!

Risk of overheating!

- Never install the TV in a confined space. Always leave a space of at least 4 inches or 10 cm around the TV for ventilation. Ensure curtains or other objects never cover the ventilation slots on the TV.

Risk of damage to the TV!

- Before you connect the TV to the power outlet, ensure that the power voltage matches the value printed on the back of the TV. Never connect the TV to the power outlet if the voltage is different.

Risk of injury, fire or power cord damage!

- Never place the TV or any objects on the power cord.
- To easily disconnect the TV power cord from the power outlet, ensure that you have full access to the power cord at all times.
- When you disconnect the power cord, always pull the plug, never the cable.
- Disconnect the TV from the power outlet and antenna before lightning storms. During lightning storms, never touch any part of the TV, power cord or antenna cable.

Risk of hearing damage!

- Avoid using earphones or headphones at high volumes or for prolonged periods of time.

Low temperatures

- If the TV is transported in temperatures below 5°C or 41°F, unpack the TV and wait until the TV temperature matches room temperature before connecting the TV to the power outlet.

Screen care

- Avoid stationary images as much as possible. Stationary images are images that remain on-screen for extended periods of time. Examples include: on-screen menus, black bars and time displays. If you must use stationary images, reduce screen contrast and brightness to avoid screen damage.
- Unplug the TV before cleaning.
- Clean the TV and frame with a soft, damp cloth. Never use substances such as alcohol, chemicals or household cleaners on the TV.
- Risk of damage to the TV screen! Never touch, push, rub or strike the screen with any object.
- To avoid deformations and colour fading, wipe off water drops as soon as possible.

Product disposal Guidelines:

	<p>For the purpose of recycling to facilitate effective utilization of resources, please return this product to a nearby authorized collection center, registered dismantler, recycler, service center when disposing of this product.</p> <p>In case of further assistance, you may contact nearest authorized service center. Or Please see the Company website for further information on collection centers etc. Visit-http://www.philips.com</p> <p>OR Standard Call Rates Apply-1860 180 1111, Toll Free Number - 1800 102 2929</p> <p>संसाधनों का प्रभावी उपयोग सुगम बनाने हेतु पुनः चक्रण के प्रयोजन से इस उत्पाद को कृपया निकटवर्ती अधिकृत संग्रहण केंद्र, पंजीकृत भंगक या रिसाइक्लर (पुनः चक्रणकर्ता) को वापस करें। अधिक जानकारी के लिए निकटवर्ती अधिकृत सर्विस सेंटर (सेवा केंद्र) से संपर्क करें। या संग्रहण केंद्रों इत्यादि के बारे में अधिक जानकारी के लिए कृपया कंपनी की वेबसाइट देखें :- Visit-http://www.philips.com</p> <p>OR Standard Call Rates Apply-1860 180 1111, Toll Free Number - 1800 102 2929</p>
---	--



3 Use your TV

Congratulations on your purchase, and welcome to Philips To fully benefit from the support that Philips offers, register your TV at www.philips.com/welcome.

3.1 Name and Function of Control on Set (22PFL5957/V7 & 24PFL5957/V7)

A) TV controls and Indicators

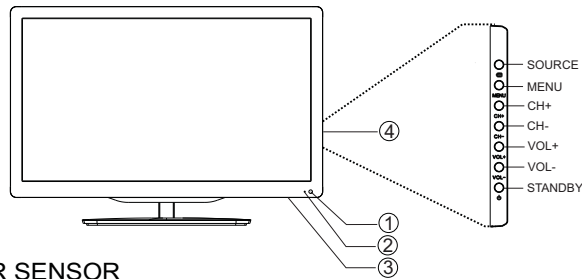

- 1) IR SENSOR
- 2) LED INDICATOR
- 3) POWER SWITCH
- 4) KEY BOARD

B) Connectivity

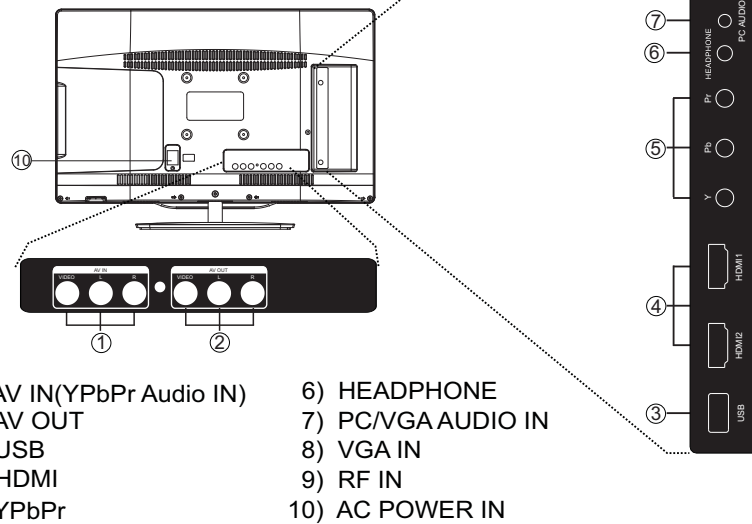

- | | |
|--------------------------|--------------------|
| 1) AV IN(YPbPr Audio IN) | 6) HEADPHONE |
| 2) AV OUT | 7) PC/VGA AUDIO IN |
| 3) USB | 8) VGA IN |
| 4) HDMI | 9) RF IN |
| 5) YPbPr | 10) AC POWER IN |

Note :

1) Above sketch and connectivity are just for representation actual product may look different as per model selection.

3.2 Name and Function of Control on Set (32PFL5937/V7 & 32PFL5957/V7)

A) TV controls and Indicators

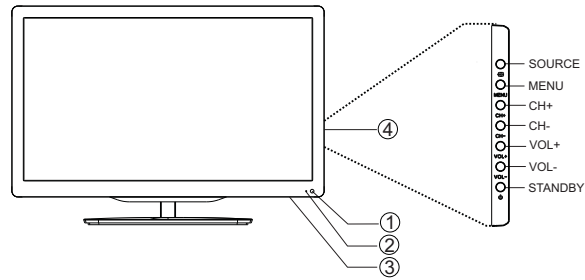

- 1) IR SENSOR
- 2) LED INDICATOR
- 3) POWER SWITCH
- 4) KEY BOARD

B) Connectivity

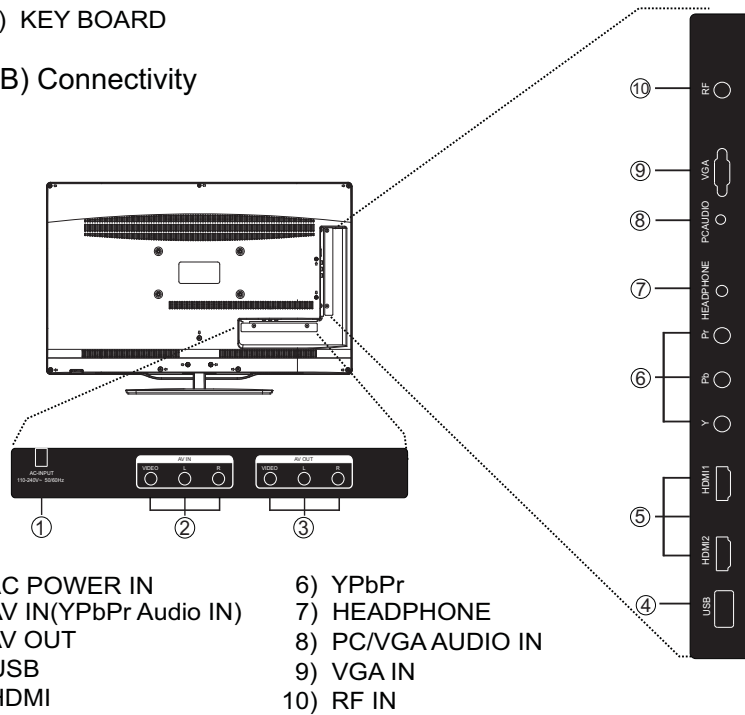









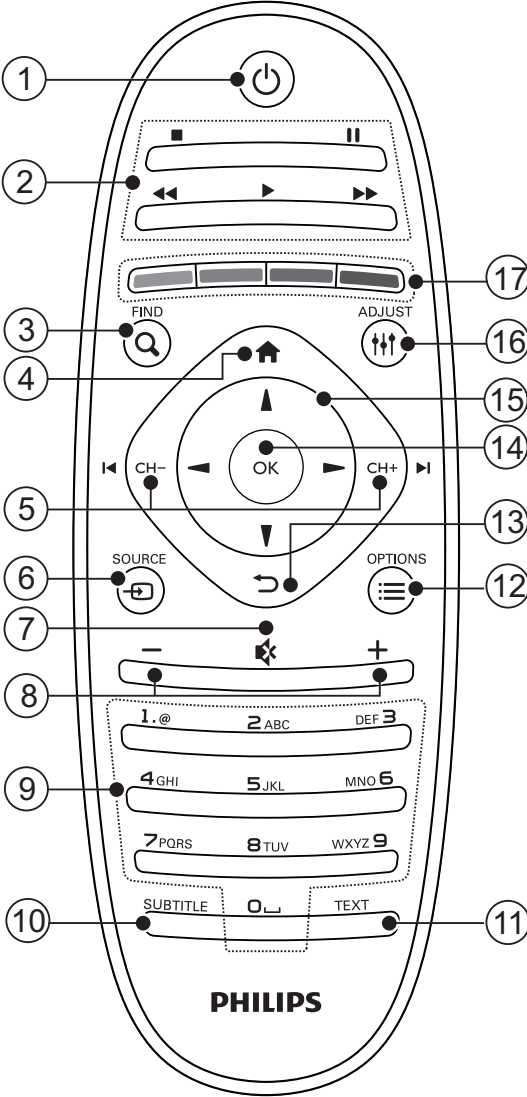



- | | |
|--------------------------|--------------------|
| 1) AC POWER IN | 6) YPbPr |
| 2) AV IN(YPbPr Audio IN) | 7) HEADPHONE |
| 3) AV OUT | 8) PC/VGA AUDIO IN |
| 4) USB | 9) VGA IN |
| 5) HDMI | 10) RF IN |

Note :

1) Above sketch and connectivity are just for representation actual product may look different as per model selection.

3.3 Name and Function of Control on Remote



- ①  (Standby-On)
 - Switches the TV ON or OFF. The TV is not powered off completely unless it is physically unplugged
- ② Multimedia Control buttons
 - Control video or music.
- ③  FIND
 - Depending on model.
- ④  (Home)
 - Access the home menu.
- ⑤  CH - / CH +  (Previous/Next)
 - Switch channels or navigate through menu pages, tracks, albums or folders.
- ⑥  SOURCE
 - Selects connected devices.
- ⑦ 
 - Mute or restore audio.
- ⑧ +/-
 - Adjust volume.
- ⑨ 0-9 Numeric buttons
 - Select channels.
- ⑩ SUBTITLE
 - Depending on model.
- ⑪ TEXT
 - Depending on model.
- ⑫  OPTIONS
 - Access options for the current activity or selection.
- ⑬ 
 - Return to the previous menu or exit a function.
- ⑭ OK
 - Confirm an entry or selection.
- ⑮  (Navigation buttons)
 - Navigate through menus and select items. (Also in USB mode).
- ⑯  ADJUST
 - Access the menu to adjust settings.
- ⑰ Color buttons
 - Select tasks or options

3.4 Remote control usage

When you use the remote control, hold it close to the TV and point it at the remote control sensor. Make sure that the line-of-sight between the remote control and TV is not blocked by furniture, walls or other objects.

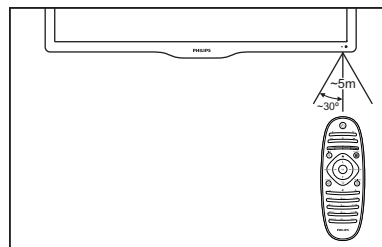

3.5 Battery Installation

1. Remove the battery compartment door.
2. Install 2 "AAA" or UM-4 (1.5V) batteries or equivalent with the correct polarity as indicated.
3. Refix the battery compartment door.

NOTE : Remove batteries when they are exhausted or if the remote control is not to be used for a long time.

BATTERY PRECAUTIONS :

Incorrect use of batteries can cause electrolyte leakage which will corrode the remote handset or cause the batteries to burst.

- Replace both batteries at the same time.
- Don't Mix battery types (alkaline with carb on, zinc etc.).
- Don't recharge.

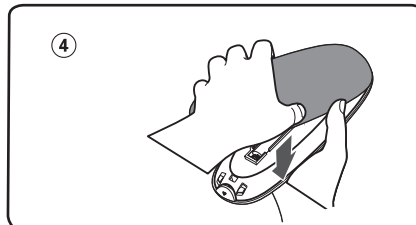
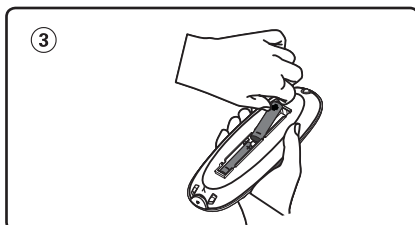
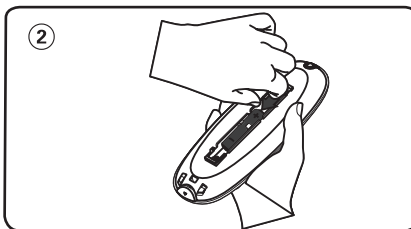
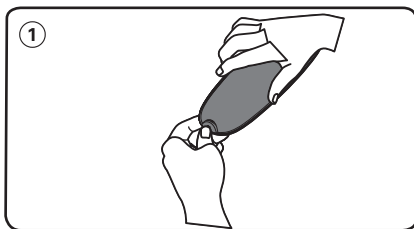

4 Use more of your TV

4.1 Main Menu

Menus help you to install channels, change picture and sound settings and access other TV features.

- 1 Press **⬆**
» The menu screen appears.

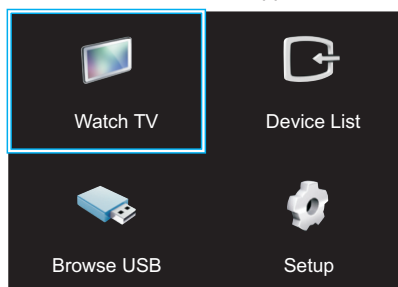

- 2 Select one of the following, then press OK
 - **[Watch TV]** : If a source other than antenna is selected, switch back to the antenna source
 - **[Browse USB]**: View photos and play music and movies contained in USB storage devices.
 - **[Device List]** : Access menus to change other source by pressing key.
 - **[Setup]** : Access menus to change picture, sound and other settings.

4.2 Manually adjust picture setting

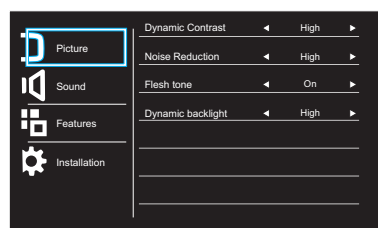
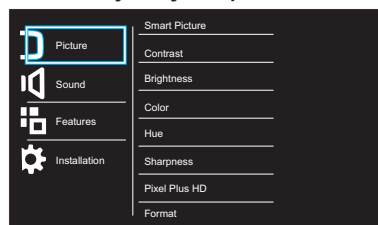

- 1 Press **⬆**
- 2 Select **[Setup]** then press OK
> Select **[Picture]**.
- 3 Select one of the following settings, then Press **▲▼** to move, and press **◀▶** to adjust.
 - **[Smart picture]** : Access predefined smart picture settings.
 - **[Contrast]** : Adjust the intensity of backlight areas, while the video contents are kept unchanged.
 - **[Brightness]** : Adjust the intensity and details of dark areas.
 - **[Color]** : Adjust color saturation.
 - **[Hue]**: Compensate for color variations. (Available only for NTSC channels).
 - **[Sharpness]** : Adjust sharpness in the image.
 - **[Pixel Plus HD]** :
To enhance the picture quality
 - **[Dynamic contrast]** : Enhance contrast, you can switch this feature Low, Middle and High.
 - **[Noise Reduction]**: Filter and reduce noise in an Image, you can switch this feature Low, Middle and High.
 - **[Flesh tone]**: Make colors more vivid and improve the details in bright colors. You can switch this feature ON or OFF.
 - **[Dynamic backlight]**: Enhance backlight, you can switch this feature Low, Middle and High.
 - **[Format]** : Select picture format.

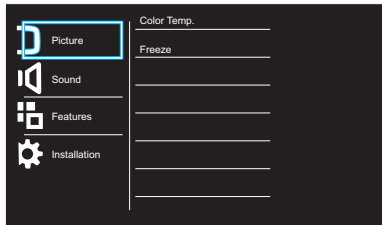

- **[Color Temp.]** : Adjust the color balance in an image.
- **[Freeze]** : Select option as ON to freeze the picture.

Note

- Depending on the format of the picture source, some picture settings may not be available.

4.3 Use Smart Picture

Use smart picture to apply pre-defined picture settings.



- 1 Press **# ADJUST**.
- 2 Select one of the following settings, by **◀▶**
 - **[Vivid]** : Rich and dynamic settings, ideal for daytime.
 - **[Cinema]** : Ideal settings for movies.
 - **[Personal]**: Apply your customised picture settings.
 - **[Bright]**: Ideal settings for night time.

4.4 Manually adjust sound setting

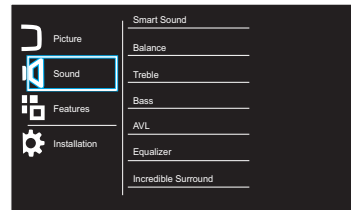

- 1 Press **▲**
- 2 Select **[Setup]** then press OK
 - > Select **[Sound]**.
- 3 Select one of the following settings, then Press **▲▼** to move, and press **◀▶** to adjust.
 - **[Smart Sound]** : Access predefined smart sound settings.
 - **[Balance]**: Adjust the balance of the right and left speakers.
 - **[Treble]** : Adjust the treble level.
 - **[Bass]** : Adjust the bass level.
 - **[AVL]** : Auto volume leveler automatically reduces sudden volume changes, for example when switching channels.
 - **[Equalizer]** : Adjust the equalizer ON various frequencies.
 - **[Incredible Surround]** : Enable Incredible Surround for stereo Sources

4.5 Use Smart Sound

Use smart sound to apply pre-defined Sound settings.



- 1 Press **# ADJUST**.
- 2 Select one of the following settings, by **◀▶**
 - **[Standard]** : Settings that suit most environments and types of audio.
 - **[Music]** : Ideal settings for listening to music.
 - **[Movie]** : Ideal settings for spoken audio, such as news.
 - **[Personal]**: Apply the settings that were customised in the sound menu.

4.6 Features Menu

- 1 Press **Home**
- 2 Select **[Setup]** then press **OK**
> Select **[Features]**
- 3 Select one of the following settings then
Press **▲▼** to move, and press **◀▶** to adjust.

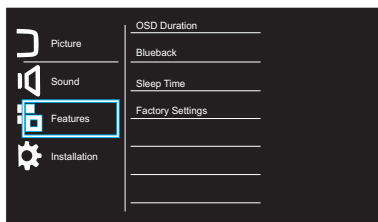

- **[OSD Duration]** : This function is used to OSD timeout in step of 15,30,45,60 secs.
- **[Blueback]** : This function is used to ON/OFF the blue screen at no signal condition.
- **[Sleep Time]** : This function is used to ON/OFF step of 10,20,30,60,90,120,180,240 mins.
- **[Factory Settings]** : This function is used for Reset to factory default settings.

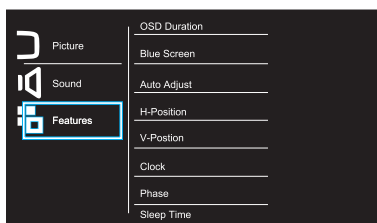

[Features in VGA Mode] :

- **[Auto Adjust]**: This automatically adjust H & V-position, Phase and Clock for VGA mode.
- **[H-Position]**: Adjust the horizontal position of image [Only in VGA].
- **[V-Position]**: Adjust the vertical position of image [Only in VGA].
- **[Clock]**: If picture is not OK with Auto Setting, then adjust by manual clock [Only in VGA].
- **[Phase]**: If picture is not OK with Auto Setting, then adjust by phase. [Only in VGA].

4.7 Installation Menu

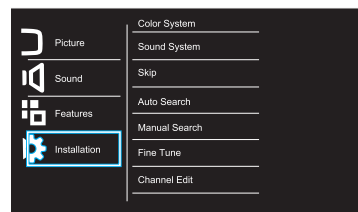

- 1 Press **Home**
 - 2 Select **[Setup]** then press **OK**
> Select **[Installation]**
 - 3 Select one of the following settings, then
Press **▲▼** to move, and press **◀▶** to adjust.
- **[Color System]** : Change the color system (AUTO/PAL/NTSC) setting if the picture is not reproduced properly.
Note: For India color system is Auto or PAL.
 - **[Sound System]**: Change the sound system (BG/M/DK/I) setting if sound is not reproduced properly.
Note: For India sound system is BG.
 - **[Skip]**: This function is used to Skip any programme.
 - **[Auto Search]** : Select the function TV set will start auto tuning for all available channels.
 - **[Manual Search]** : Select this for manually searching the channels, select the function from which tuning will start.
 - **[Channel Edit]**: You can Delete, Rename, Move or Skip any programmes.

Channel Edit			
Program No.	Frequency	Name	Skip
1	55.25MHz	----	On
2	62.25MHz	----	Off
3	69.25MHz	----	Off
4	76.25MHz	----	Off
5	97.25MHz	----	Off
6	112.25MHz	----	Off
7	119.25MHz	----	Off
8	126.25MHz	----	Off
9	147.25MHz	----	Off
10	161.25MHz	----	Off

Delete

Select Delete option by Pressing Red color button, the program will be deleted.

Name

Move the cursor to the program, Select Rename option by pressing Green color button to rename the program. Press ▲▼ to choose the character. Press ◀▶ to move the cursor. Press OK button to Enter, Press Menu button to Return the Edit Menu.

Move

Move the cursor to the program, Select Move option by pressing Yellow color button and press ▲▼ to move the program. Select program no on which you want move the current program, then press ok key.

Skip

Select Skip option by pressing Blue color button to skip this program.

4.8 Use the Options menu



- While you watch TV, press . The TV options menu appears for Freeze and Incredible Surround by pressing options key cyclic.
- Select one of the following options, switch to ON/OFF by ◀▶.
 - [Freeze]:** Freeze the moving picture
 - [Incredible Surround]:** Enable Incredible Surround for stereo Sources

5 Play photos, music and videos on USB storage devices

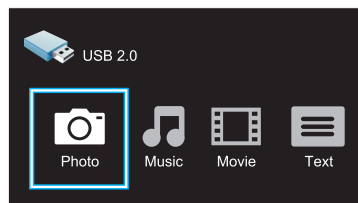

5.1 Connect a USB storage device to play photos, music or videos stored on it.

- Switch on the TV.
- Connect the USB device to the USB port on the side of your TV.
- Press .
- Select **[Browse USB]**, then press OK. The USB browser appears.

5.2 View photos

- In the USB browser, select **[Photo]**, then press OK.
- Select a photo or a photo album by pressing OK key, then press ▶ to view the photo.

5.3 View a slide show of your photos

Press the following buttons to control play of selected photos.:

Select photos by pressing OK key :

- ▶ to play.
- ⏸ to pause.
- ◀ or ▶ to play the previous or next photo.

5.4 Listen to music

- In the USB browser, select **[Music]**, then press OK.
- Select a music track or album by pressing OK key.
 - ▶ to play.
 - ⏸ to pause.
 - ◀ or ▶ to play the previous or next

5.5 Watch video

- 1 In the USB browser, select **[Movie]**, then press OK.
- 2 Select video files by OK key.
- 3 To control play, press the play buttons:
 - ▶ to play/pause.
 - ◀ or ▶ to play the previous or next video.

5.6 Text

- 1 In the USB browser, select **[Text]**, then press OK.
- 2 Select a Text File, then Press ▶ to play.

5.7 Music, Photo, Movie, Text mode control menu bars

You can select the multimedia functions like play, Pause, FF, FB, Next, Previous, Stop etc.

To use above functions press OK key while playing files on TV screen.

Picture mode menu bar:

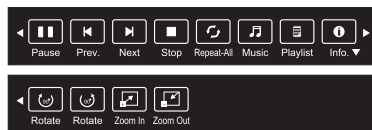

Press ◀▶ to select the function icon, press OK button to confirm the function.

Music mode menu bar:



Press ◀▶ to select the function icon, press OK button to confirm the function.

Movie mode menu bar:

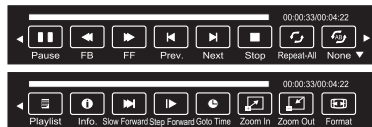

Press ◀▶ to select the function icon, press OK button to confirm the function.

Text mode menu bar:



Press ◀▶ to select the function icon, press OK button to confirm the function.

5.9 Disconnect a USB storage device



Caution

- Follow this procedure to avoid damage to your USB storage device.

- 1 Press ↵ to exit the USB browser.
- 2 Wait for five seconds, then disconnect the USB storage device.

6 Troubleshooting

This section describes commonly encountered issues and accompanying solutions.

6.1 General TV issues

The TV does not switch on:

- Disconnect the power cable from the power outlet. Wait for one minute then reconnect it.
- Check that the power cable is securely connected.

The remote control is not working properly:

- Check that the remote control batteries are correctly inserted according to the +/- orientation.
- Replace the remote control batteries if they are flat or weak.
- Clean the remote control and TV sensor lens.

The standby light on the TV blinks red:

- Disconnect the power cable from the power outlet. Wait until the TV cools down before reconnecting the power cable. If the blinking reoccurs, contact Philips Consumer Care.

When turning the TV on/off/to standby, you hear a creaking sound from the TV chassis:

- No action is required. The creaking sound is normal expansion and contraction of the TV as it cools down and warms up. This does not impact performance.

6.2 TV channel issues

Previously installed channels do not appear in the channel list:

- Check that the correct channel list is selected.

6.3 Picture issues

The TV is on, but there is no picture:

- Check that the antenna is properly connected to the TV.
- Check that the correct device is selected as the TV source.

There is sound but no picture:

- Check that the picture settings are correctly set.

There is poor TV reception from an antenna connection:

- Check that the antenna is properly connected to the TV.
- Loudspeakers, unearthed audio devices, neon lights, high buildings and other large objects can influence reception quality. If possible, try to improve the reception quality by changing the antenna direction or moving devices away from the TV.
- If reception on only one channel is poor, fine tune this channel.

There is poor picture quality from connected devices:

- Check that the devices are connected properly.
- Check that the picture settings are correctly set.

The TV did not save your picture settings:

- Check that the TV location is set to the home setting. This mode offers you the flexibility to change and save settings.

The picture does not fit the screen; it is too big or too small:

- Try using a different picture format.

The picture position is incorrect:

- Picture signals from some devices may not fit the screen correctly. Check the signal output of the device.

6.4 Sound issues

There is a picture but sound quality is poor:

 **Note**

- If no audio signal is detected, the TV automatically switches the audio output off this does not indicate malfunction.

- Check that all cables are properly connected.
- Check that the volume is not set to 0.
- Check that the sound is not muted.

There is a picture but the sound quality is poor:

- Check that the sound settings are correctly set.

There is a picture but sound comes from one speaker only:

- Verify that sound balance is set to the centre.

6.5 HDMI connection issues

There are problems with HDMI devices:

- If the TV does not recognise the HDMI device and no picture is displayed, try switching the source from one device to another and back again.
- If there are intermittent sound disruptions, check that output settings from the HDMI device are correct.
- If you use an HDMI-to-DVI adapter or HDMI-to-DVI cable, check that an additional audio cable is connected to AV IN.

6.6 Computer connection issues

The computer display on the TV is not stable:

- Check that your PC uses the supported resolution and refresh rate.
- Select the "Auto Adjust" function.
 1. Press 
 2. Select **[Setup] >[Features] > [Auto Adjust]**.

6.7 Contact us

If you cannot resolve your problem, refer to the FAQs for this product at www.philips.com/support or Contact Customer Service Center.

 **Warning**

- Do not attempt to repair the product yourself. This may cause severe injury, irreparable damage to your product or void your warranty.

 **Note**

- Make a note of your TV model and serial number before you contact Philips. These numbers are printed on the back of the TV and on the packaging.

7 Product information

Product information is subject to change without notice. For detailed product information, go to www.philips.com/support.

7.1 Supported display resolutions

Computer formats (HDMI)

- Resolution - refresh rate:
 - 720 x 480p - 60Hz
 - 720 x 576p - 50Hz
 - 1280 x 720p - 50Hz,60Hz
 - 1920 x 1080p -50Hz,60Hz

Computer formats (VGA)

- Resolution - refresh rate:
 - 640 x 480 - 60Hz,72Hz,75Hz
 - 800 x 600 - 56Hz,60Hz,72Hz,75Hz
 - 1024 x 768 - 60Hz,70Hz,75Hz
 - 1280 x 1024 - 60Hz

Video Formats

- Resolution - refresh rate:
 - 720 x 480i - 60Hz
 - 720 x 480p - 60Hz
 - 720 x 576i - 50Hz
 - 720 x 576p - 50Hz
 - 1280 x 720p - 50Hz, 60Hz
 - 1920 x 1080i - 50Hz, 60Hz



Note

- 1) 1080p support only for FHD model

7.2 Tuner/Reception/Transmission

- Antenna input: 75ohm coaxial (IEC75)
- TV system: PAL, B/G
- Video playback: NTSC,PAL
- Tuner Bands: UHF, VHF

7.3 Remote control

- Type: YKF293-001
- Batteries: 2 x AAA (LR03 type)

7.4 Multimedia

- Supported USB storage device:
(Only FAT 16 or FAT 32 USB storage devices are supported)
- Supported storage file formats:
 - Images : JPEG, BMP, PNG
 - Audio : MP3,WMA.
 - Text : TEXT
 - Video :

File Extention	Container	Video Decoder
*.avi	AVI	MPEG 1/2/4 H.264
*.mp4 *.mov	MP4	MPEG 4 H.264
*.mkv	MKV	MPEG 4 H.264
.mpg/ .mpeg	PS	MPEG 1/2
*.wmv	ASF	VC-1



Note

- 1) USB file names must not exceed 128 characters.
- 2) The USB features/functions may vary from file to file depending on relative information present in the file

7.5 Power

- Mains power: 110-240V, 50Hz-60Hz
- Ambient temperature: 5 to 40 degrees Celsius
- Power consumption
 - 22PFL5957/V7: 38W
 - 24PFL5957/V7: 40W
 - 32PFL5937/V7: 75W
 - 32PFL5957/V7: 75W

7.6 Supported TV mounts

To mount the TV, purchase a Philips TV mount or VESA - compatible TV mount. To Prevent damage to cables and connectors, be sure to leave a clearance of at least 2.2 inches or 5.5 cm from the back of the TV.



Warning

Follow all instructions provided with the TV mount. PE Electronics Ltd. bears no responsibility for improper TV mounting that results in accident, injury or damage.

TV screen size (inches)	Required pitch (mm)	Required mounting bolts
22PFL5957/V7	100 x 100	4 x M4
24PFL5957/V7	100 x 100	4 x M4
32PFL5937/V7	200 x 100	4 x M6
32PFL5957/V7	200 x 100	4 x M6

7.7 Product specification

Design and specifications are subject to change without notice.

22PFL5957/V7

- With TV stand
- Dimension(WxDxH): 518 x 160 x 363 (mm)
- Weight: 3.3 kg
- Without TV stand
- Dimension(WxDxH): 518 x 38 x 325 (mm)
- Weight: 2.9 kg

24PFL5957/V7

- With TV stand
- Dimension(WxDxH): 562 x 160 x 388 (mm)
- Weight: 3.9 kg
- Without TV stand
- Dimension(WxDxH): 562 x 43 x 347 (mm)
- Weight: 3.4 kg

32PFL5937/V7 & 32PFL5957/V7

- With TV stand
- Dimension(WxDxH): 747 x 180 x 495 (mm)
- Weight: 7.4 kg
- Without TV stand
- Dimension(WxDxH): 747 x 43 x 459 (mm)
- Weight 6.7 kg

Consumer Guidelines

1. Kindly ensure that the dealer fill out Warranty card correctly.
2. To avail the Warranty please register your product with the Philips-
 - Log on to www.Philips.comOR
 - Contact Philips Consumer Care Centre
3. In the unlikely event of a defect developing in the TV set contact the Philips Customer Care Centre for obtaining warranty service and inform of the defect observed in the set, the type no. and serial no. of the set.
4. On your lodging a complaint, a trained technician will call on you promptly. In the event of the technician deciding that set requires attention at the service station; the technician would arrange to get the set picked up to be delivered to service station for further attention. "Homecalls" by the technician would however be restricted within the municipal limits of the city/town in which the set has been registered.

Type no. _____ Serial No. _____ Date of Purchase _____

Purchased By: Name _____

Address: _____

_____ Tel.No. _____

Sold by: Name _____

Address: _____

_____ Tel.No. _____

<p>PHILIPS</p> <p>Model no.: 22PFL5957/V7 24PFL5957/V7 32PFL5937/V7 32PFL5957/V7</p> <p>Serial no.: <input type="checkbox"/></p>

Sold by (User rubber stamp)

Contact Customer Service Executive at:
1860 180 1111 (Standard Call Rates Apply)
1800 102 2929 (Toll Free No.)

Regd Office: PE Electronics Ltd, Auto Cars Compound, Adalat Road, Aurangabad, 431005.

WARRANTY

This TV receiver is covered under warranty against any defect arising out of faulty or defective material or workmanship for a period of 12 months from the date of purchase.

Should a defect develop in this set during the period of warranty, PE Electronics Limited undertakes to get the set repaired free of charge either

From whom the set has been purchased or through an Authorised Service Center for warranty service. However, if the Purchaser has to shift his residence to another town on account of transfer or other reasons, the warranty benefit will be available at the Authorised Service Center of that town.

The warranty is not valid in case of any of the following events:

- The TV set is not used according to instructions given in the 'Direction for use' / 'User Manual'
- Defects are caused by improper or reckless use.
- Any repair work carried out by persons other than a Philips dealer or Authorised Service Center.
- Any modification or alteration of any nature made in the electrical circuitry of the set.
- This Warranty Card is not completed and signed immediately on delivery of the set by the Philips Dealer.
- Fading effects and/or Ghosts (Multiple Image) in picture, if any, arising due to location / signal reception.
- Defects due to causes beyond control like lightning, abnormal voltage, Acts of God or while in transit to purchaser's residence.

(Refer Consumer Guidelines for further details)

PHILIPS

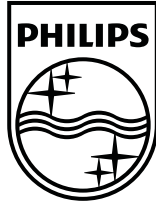

Specifications are subject to change without notice.
PHILIPS and the PHILIPS Shield Emblem are registered trademarks of
Koninklijke Philips Electronics N.V. and are used under license from
Koninklijke Philips Electronics N.V.
www.philips.com