

• 50"/58"/65":x4

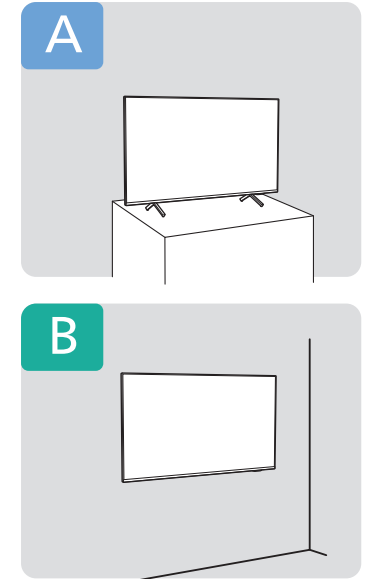

A

1a

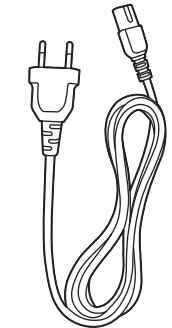
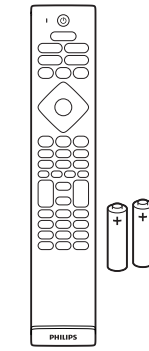
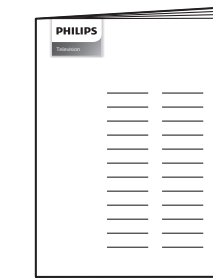

50"/58"

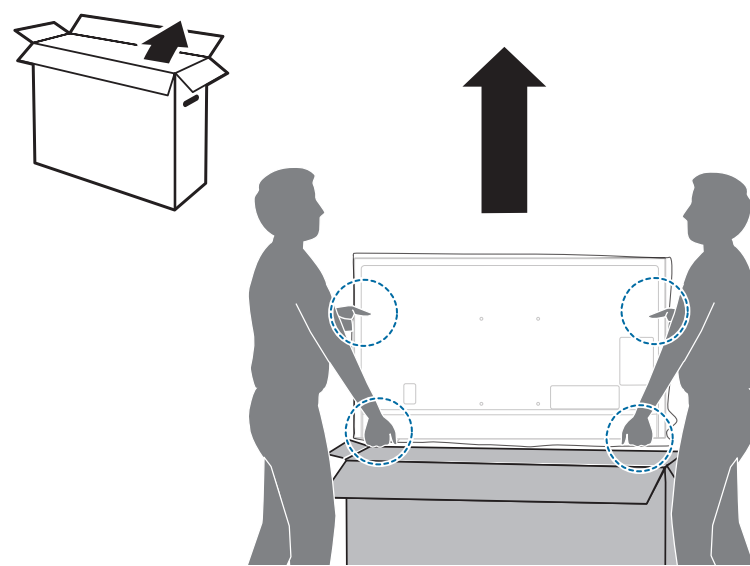

1b

65"

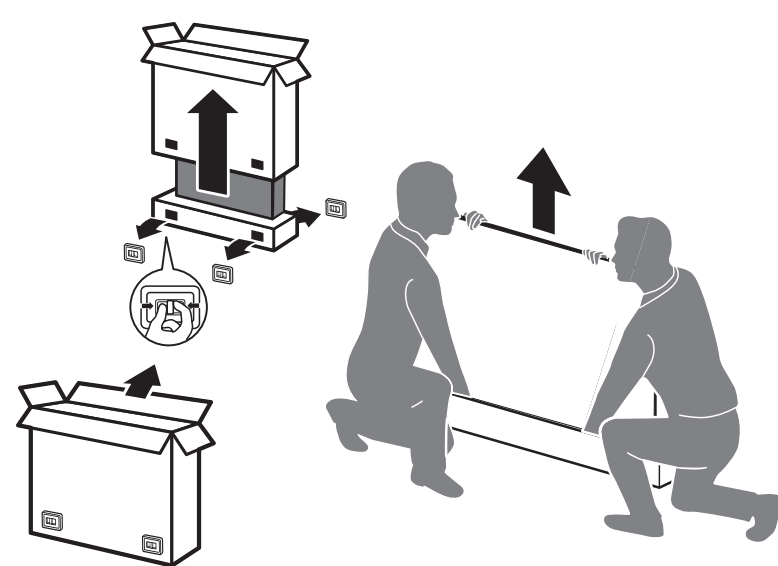

2

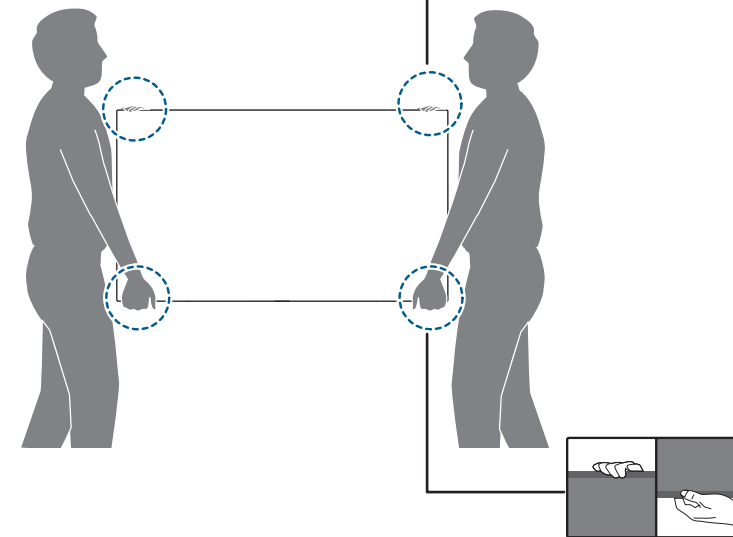

3

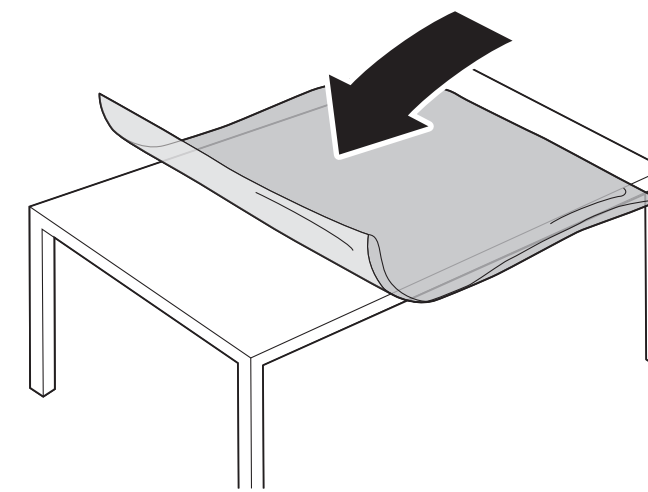

4

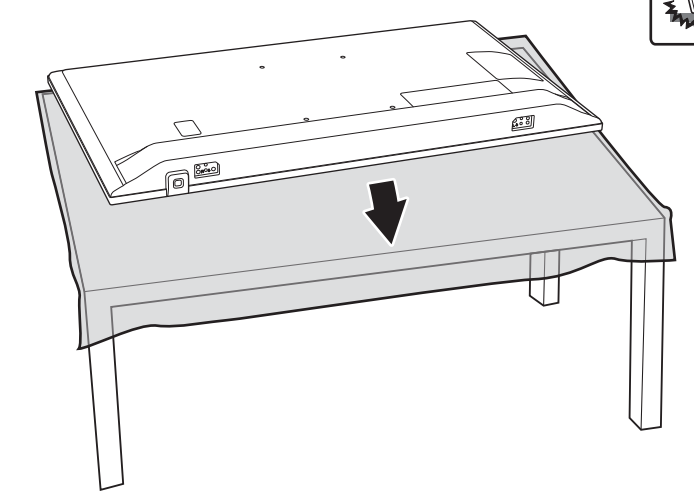
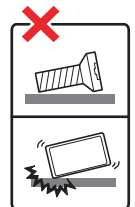

5a

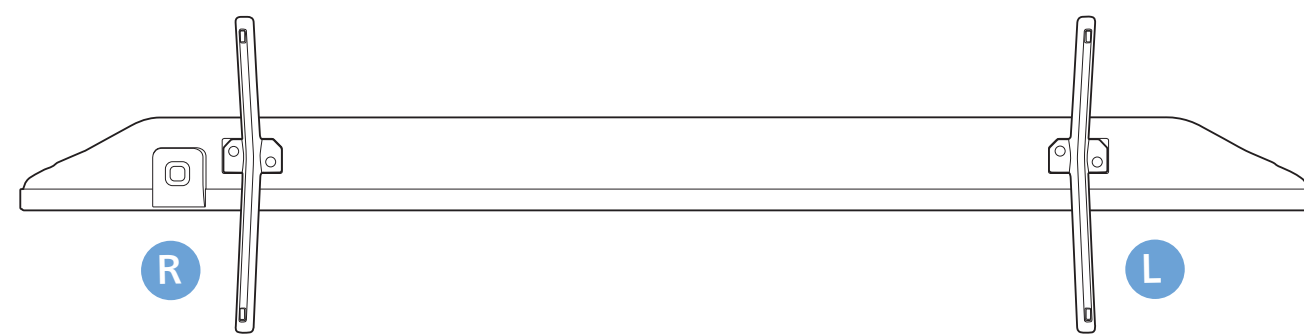

R + L

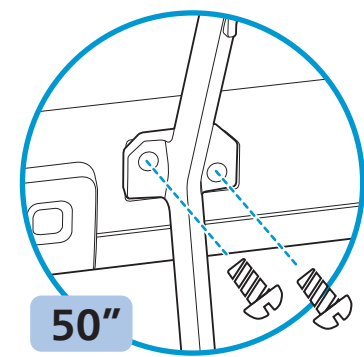
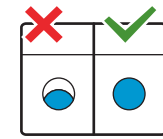

50"

5b

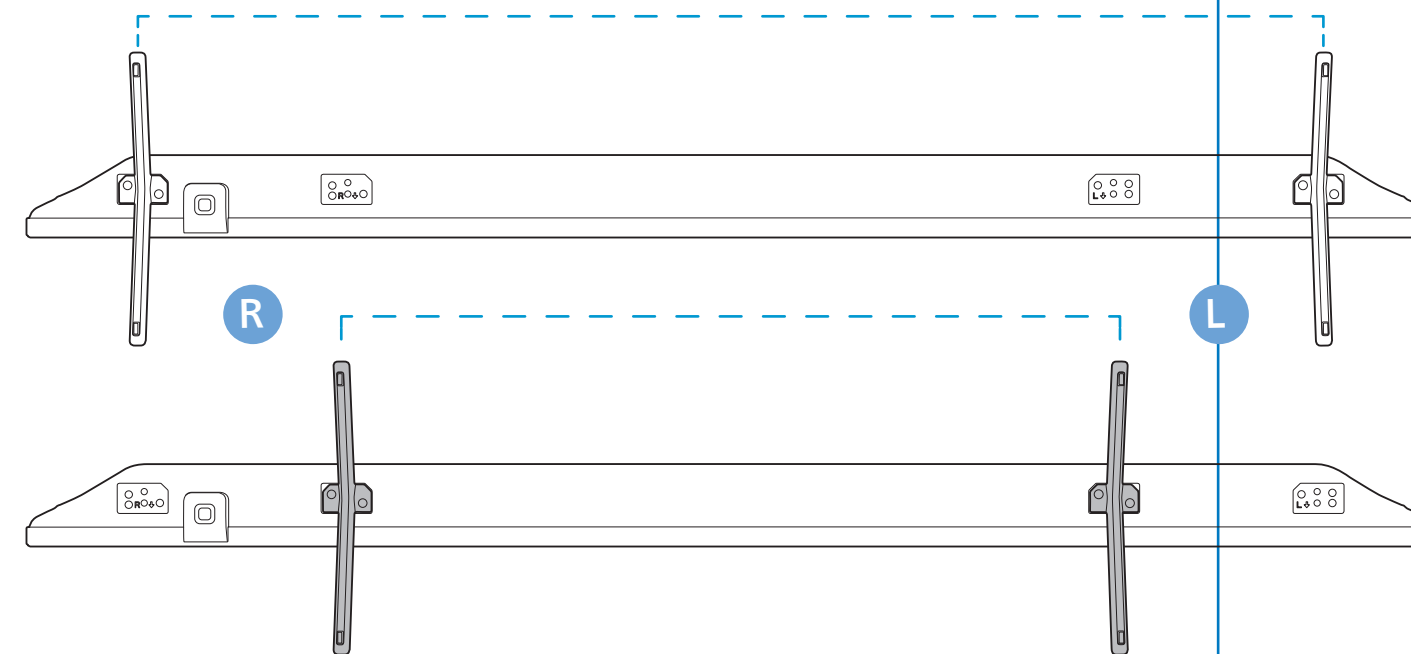

R + L

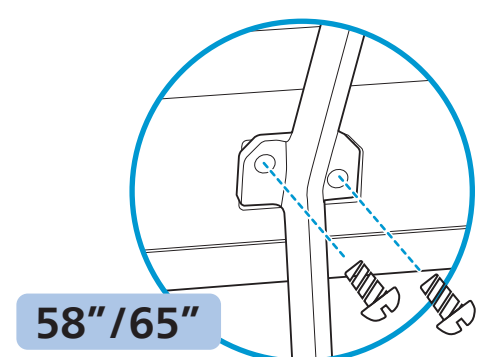
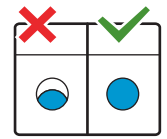

58"/65"

6



15 cm

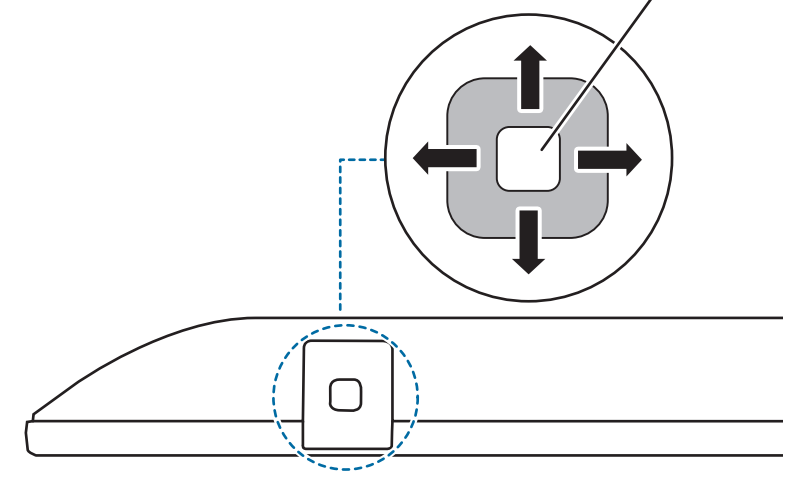
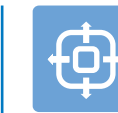
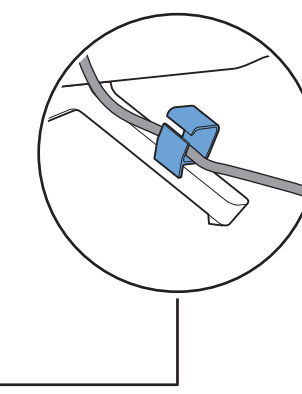
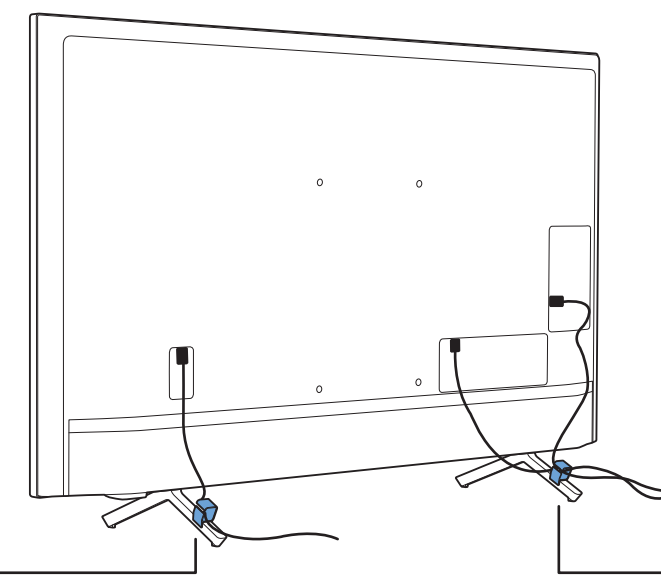
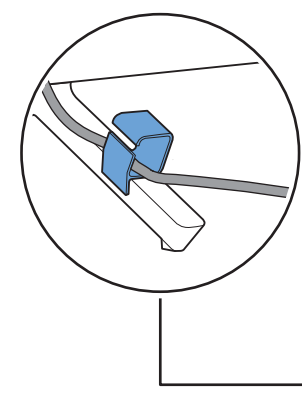
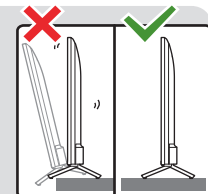
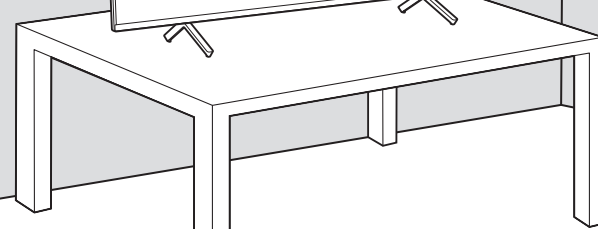

⏻/OK

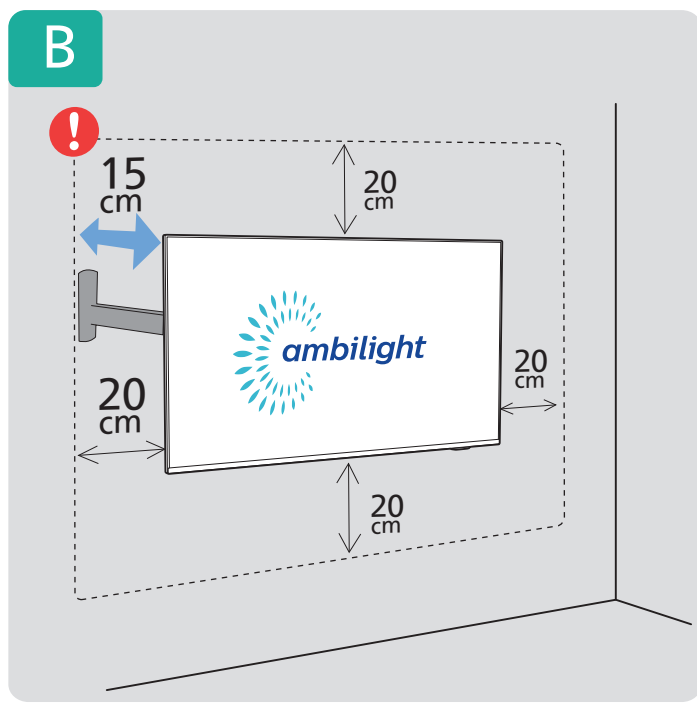

1 58"/65"



English
Türkçe

Read the safety instructions.
Güvenlik talimatlarını okuyun.



Register your product and get support at
www.philips.com/TVsupport

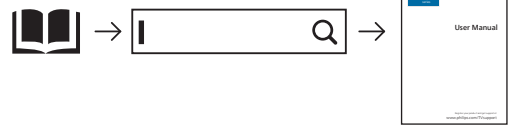

2 VESA (x, y)

50" 200x300mm M6 (L: 10mm~16mm) 126 cm

58" 200x300mm M6 (L: 10mm~16mm) 146 cm

65" 300x300mm M6 (L: 12mm~20mm) 164 cm

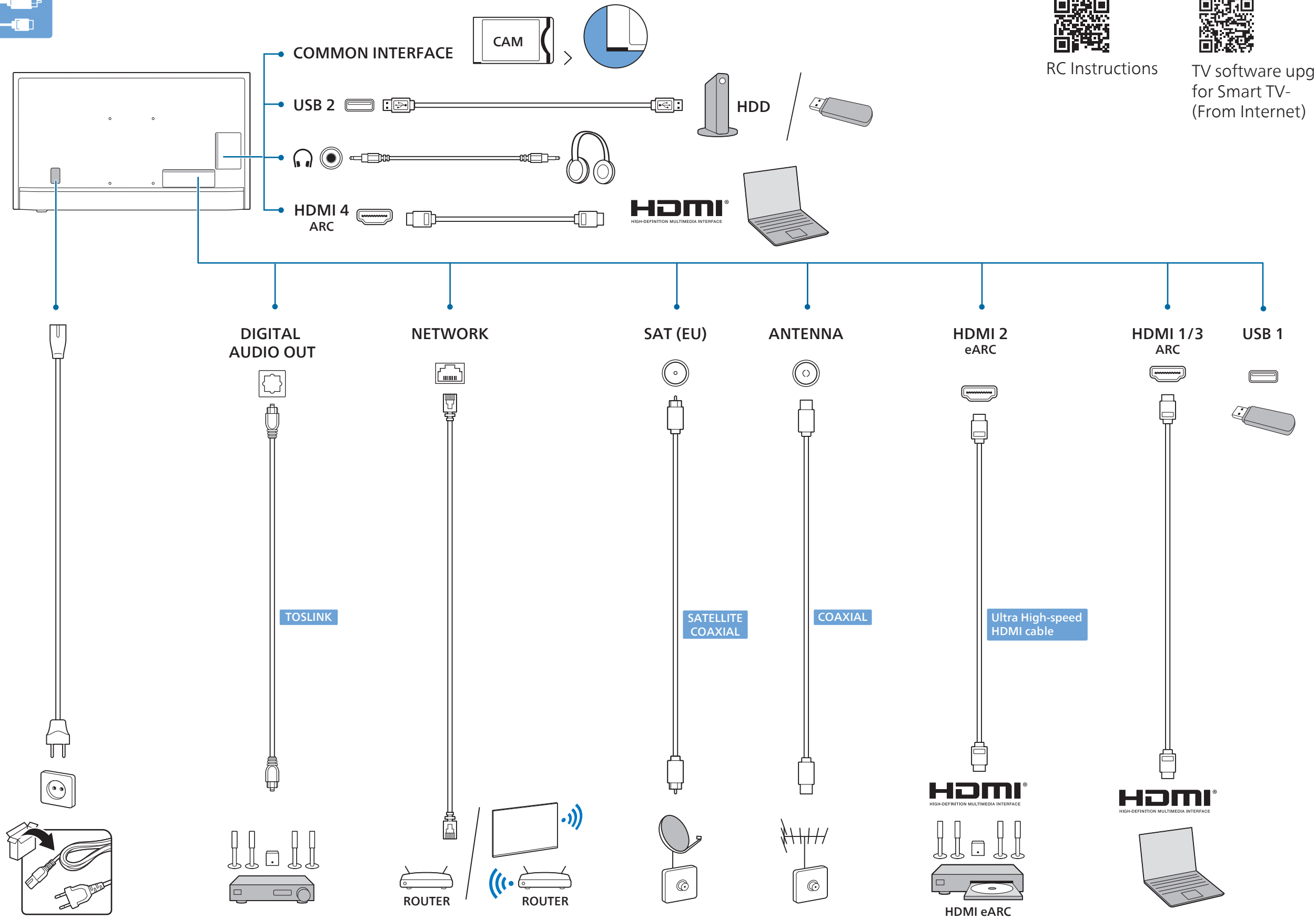
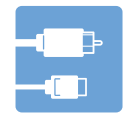
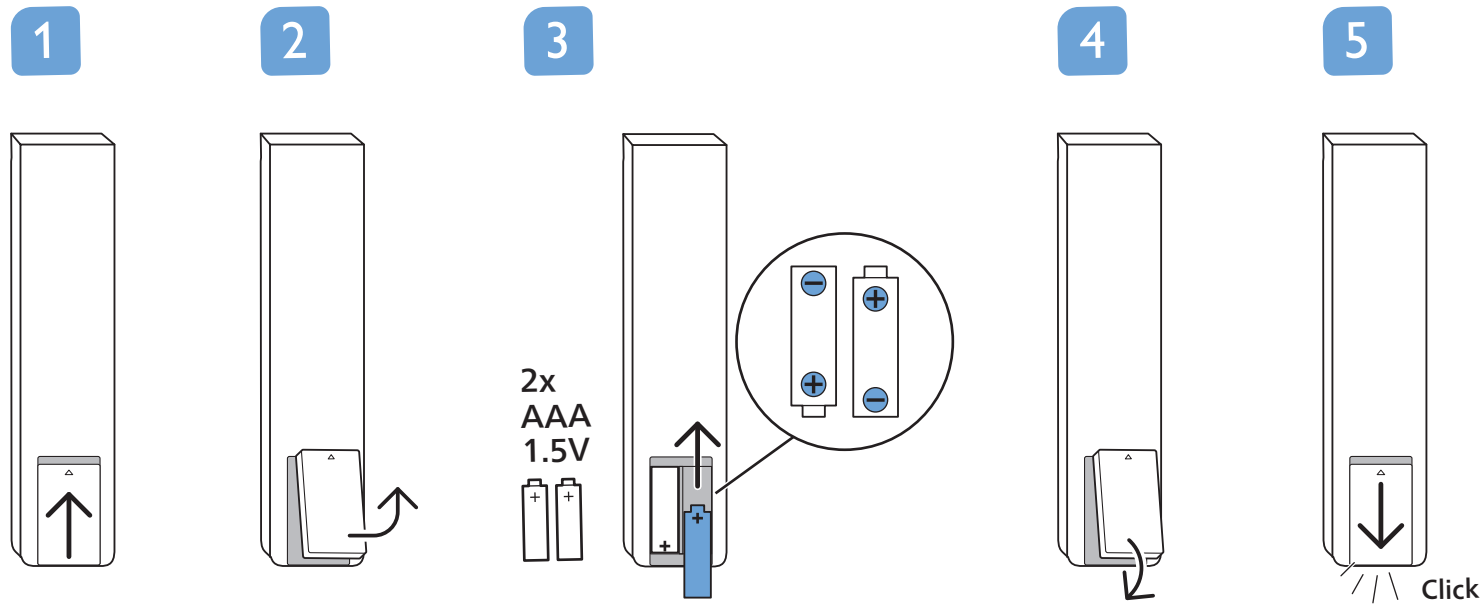
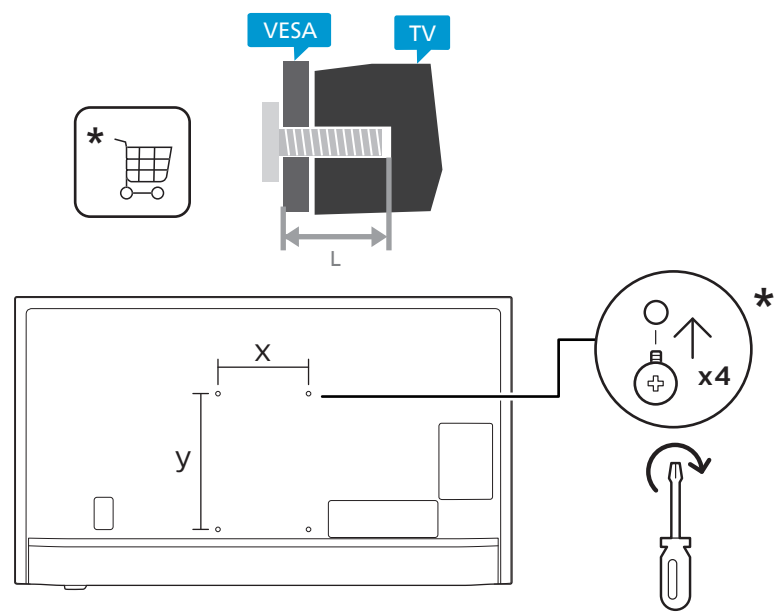

RC Instructions



TV software upgrade
for Smart TV-
(From Internet)

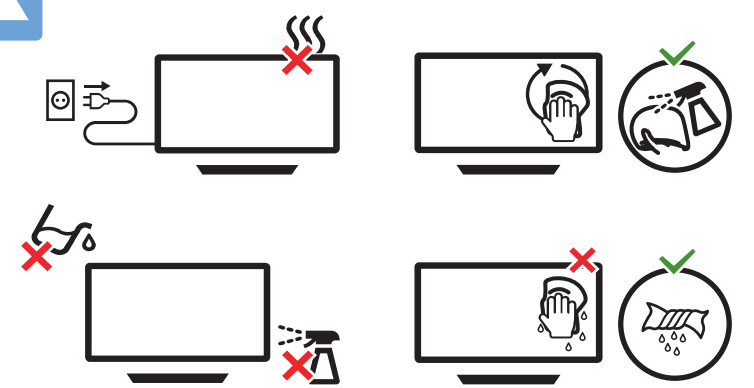
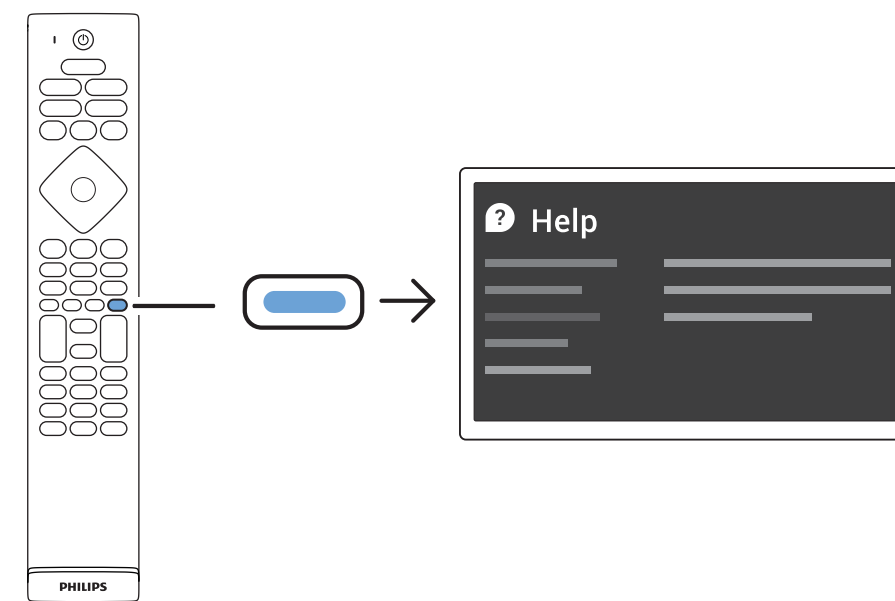
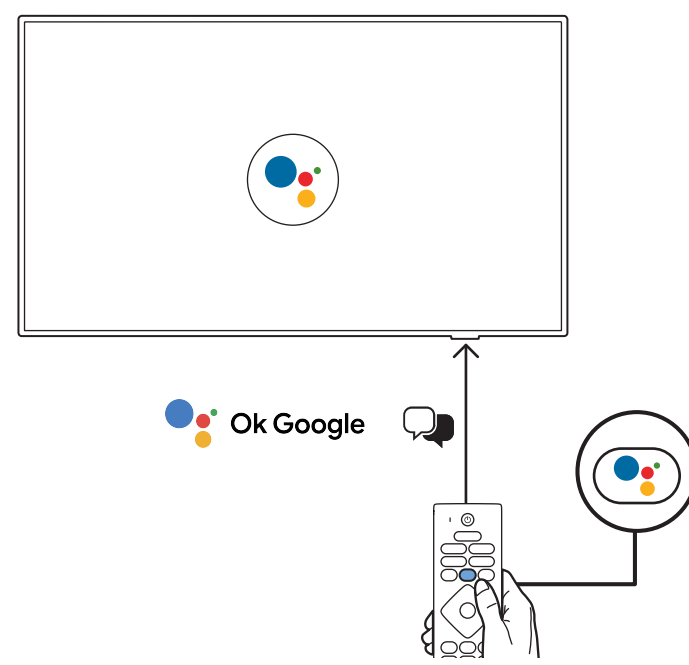
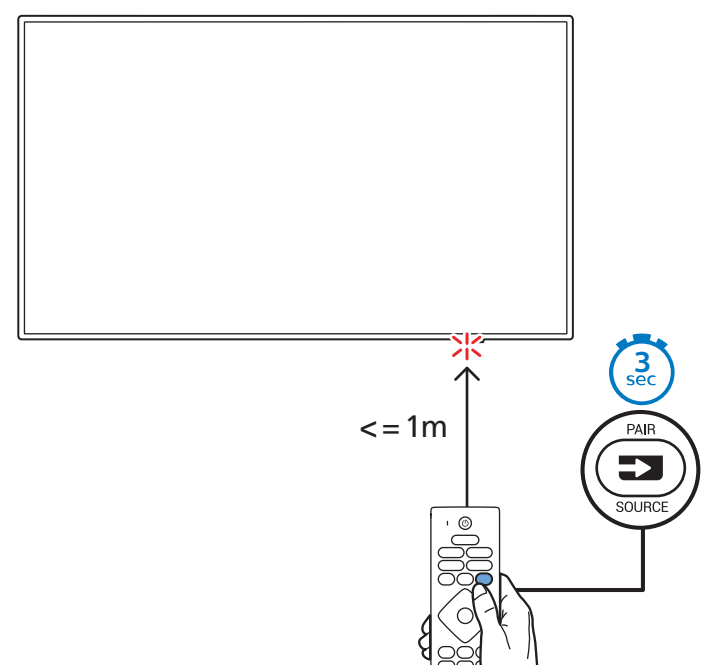

All registered and unregistered trademarks are property of their respective owners. Specifications are subject to change without notice. Philips and the Philips' shield emblem are trademarks of Koninklijke Philips N.V. and are used under license from Koninklijke Philips N.V. This product has been manufactured by and is sold under the responsibility of TP Vision Europe B.V. and TP Vision Europe B.V. is the warrantor in relation to this product. 2022 © TP Vision Europe B.V. All rights reserved. www.philips.com/welcome