



User manual

Lumileds is the warrantor of this product.
The Philips trademarks are used under license form Koninklijke Philips N.V.(2019).
©Lumileds Holding B.V 2017. All rights reserved

3211 008 22191

English

Before you start

Thank you for buying the Philips LED Inspection lamp. Its high-quality LED lighting offers a powerful wide-angle light output that will let you work in your workshop, garage or any other professional environment under the best lighting conditions.



The Philips LED Inspection lamp bears the official Philips Automotive Grade Quality seal. It is your assurance that it is manufactured or licensed by Philips using the highest-quality components and materials. Philips brings you the professional lighting tool you need. It combines Philips Original Quality, durability, and simple-to-use design.

2

⚠ Important

Please read this user guide carefully before using your LED inspection lamp. This guide contains important health and safety information.

If you need further assistance, please dial the Philips Lighting consumer care **toll-free number** in your region

www.philips.com/support

Or visit your local Philips Dealer

For more information visit
<http://www.philips.com/led-work-lights>

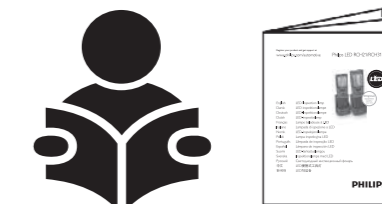
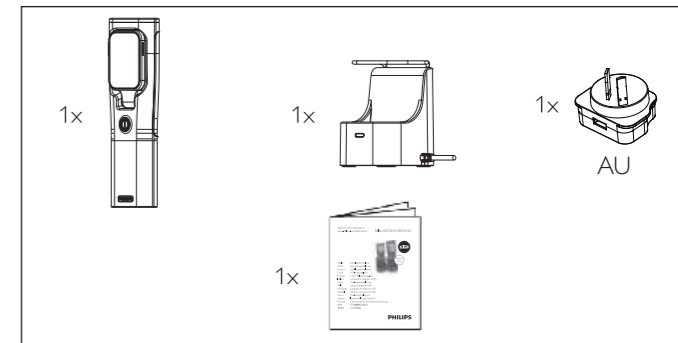

3

3

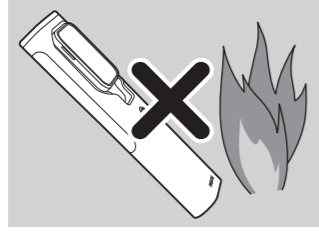
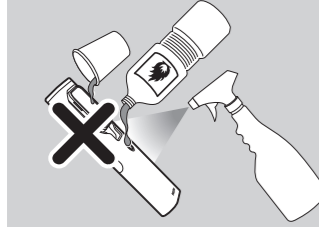
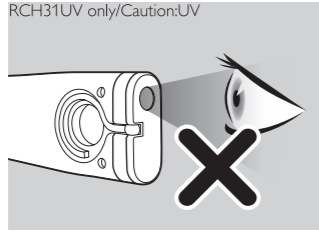
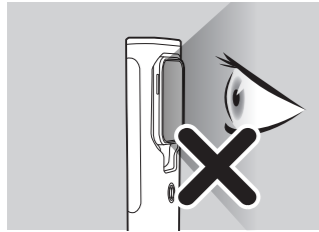

4

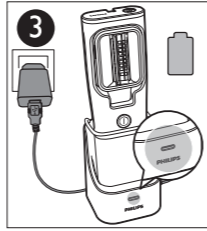
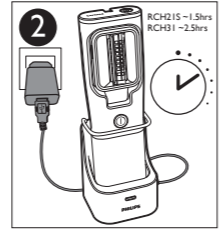
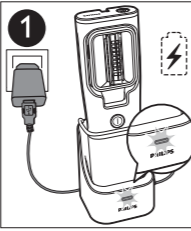
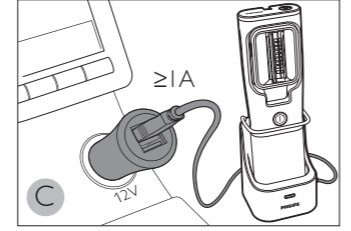
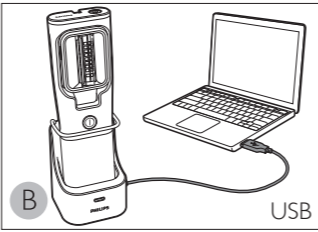
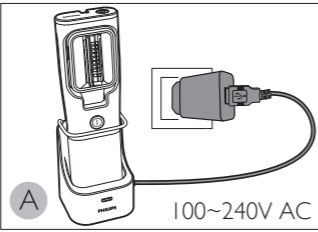

5

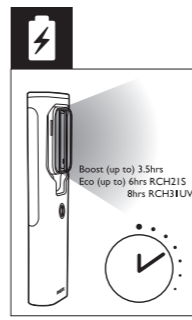
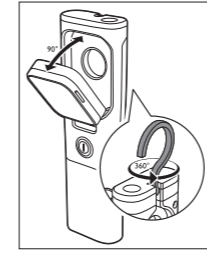
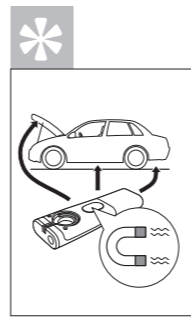
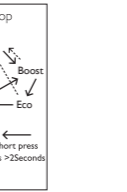
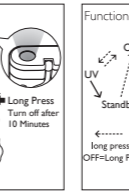
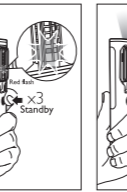
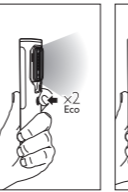
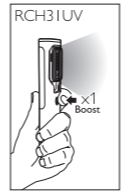
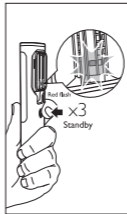
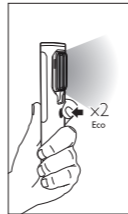
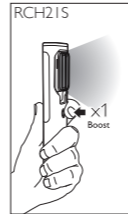

6

Description	
Operating line voltage	100-240V/Output 5V/1A
Charging time	RCH21S ~2hrs/RCH31UV ~2.5hrs *Charge at a very low temperature such as blew 0℃ will get a lower capacity and reduce cycle life of the battery.
Battery capacity	RCH21S 1800mAh/RCH31UV 3000mAh
Battery performance @25°C 60RH (Up to)	RCH21S Boost 3.5hours/Eco 6hours RCH31UV Boost 3.5hours/Eco 8hours
Light output (Lumen) @25°C 60RH (Up to)	Boost Eco RCH21S 300lm 120lm RCH31UV 350lm 150lm
UV light	RCH31UV only/ CAUTION:UV emitted from this product UV light automatic turn off after 10 minutes.
Standby	Red LED flash RCH21S 15Days/RCH31UV 30Days
Lamp module	90°Rotating
Impact protection rating	RCH21S IK08 / RCH31 IK07
Ingress protection rating	RCH21S IP65 / RCH31 IP54
Operating temperature	-10°C to 50°C / -14°F to 122°F (US)
Adaptor operating temperature	0°C to 40°C / 32°F to 104°F (US)
Storage temperature	-20°C to 60°C / -4°F to 140°F (US)
Lamp dimensions/weight	RCH21S 170*59mm 210.5g RCH31UV 200*63.5mm 268g
Magnet	Yes
Connection	USB charging cable
Docking station	Yes, 150g with charger