

Register your product and get support at
www.philips.com/welcome

PicoPix

PPX3614



EN User Manual

PHILIPS

Table of Contents

| | | | |
|-----------------------------------------------------------------------------|-----------|-----------------------------------------|-----------|
| Overview | 2 | 8 Digital TV Playback..... | 27 |
| Dear Customer | 2 | Connecting the Aerial | 27 |
| About this User Manual | 2 | First Playback | 28 |
| What's in the Box | 2 | Television | 29 |
| Product Highlights | 2 | | |
| 1 General Safety Information | 3 | 9 Android..... | 30 |
| Setting up the Device | 3 | Calling Android | 30 |
| Repairs | 3 | Exiting Android | 30 |
| Power Supply | 4 | Resetting Android | 30 |
| Wireless Network (WLAN) | 4 | Installing Android-Apps | 30 |
| | | Adjust Browser Mode | 32 |
| 2 Overview..... | 5 | 10 Settings..... | 34 |
| Top of the Device | 5 | Overview of the Menu Functions | 34 |
| Bottom of the Device | 5 | | |
| Side View | 5 | 11 Service | 36 |
| Pico Station | 6 | Care Instructions for the Battery | 36 |
| Touchpad / Gestures | 7 | Battery deep discharge | 36 |
| Remote Control | 9 | Cleaning | 37 |
| Overview of the Menu Functions | 10 | Device Overheated | 37 |
| Symbols in the Statusbar | 10 | Update Firmware with Memory Card | 37 |
| | | Troubleshooting | 38 |
| 3 Initial Operation | 11 | 12 Appendix | 40 |
| Setting up the Device | 11 | Technical Data | 40 |
| Connect Power Supply / Charge Battery | 11 | Accessories | 40 |
| Installing or Changing the Batteries of the Remote Control | 11 | | |
| Using the Remote Control | 12 | | |
| Initial Installation | 13 | | |
| 4 Connect to the Playback Device | 14 | | |
| Connecting to Devices with HDMI Output | 14 | | |
| Connecting to an iPhone/iPad/iPod | 14 | | |
| Connecting to a Computer (VGA) | 15 | | |
| Connecting Using an Audio/Video (CVBS) Adapter Cable | 15 | | |
| Connecting using Component-Video (YPbPr/YUV) Cable | 16 | | |
| Directly Connecting Projector to Computer using WLAN (WiFi Streaming) | 17 | | |
| Connecting the headphones | 17 | | |
| 5 Memory..... | 18 | | |
| Inserting a Memory Card | 18 | | |
| Connecting USB Storage Medium | 18 | | |
| Connect to a Computer (USB) | 19 | | |
| 6 Wireless Network (WLAN) | 20 | | |
| Switching Wireless Networking (WLAN) on/off | 20 | | |
| Setting up a Wireless Network (WLAN) | 20 | | |
| Setting up a Wireless Network (WLAN) Using the Wizard | 21 | | |
| Digital Living Network Alliance (DLNA) | 21 | | |
| 7 Media Playback..... | 22 | | |
| Video playback | 22 | | |
| Photo Playback | 23 | | |
| Music Playback | 24 | | |
| Office Playback (YOZO Office) | 25 | | |
| Managing Files | 25 | | |

Overview

Dear Customer

Thank you for purchasing our Pocket Projector.
We hope you enjoy your device and its many functions!

About this User Manual

With the installation guide on the following pages, you can start using your device quickly and easily. Detailed descriptions can be found in the following sections of this user manual.

Read the entire user manual carefully. Follow all safety instructions in order to ensure proper operation of your device. The manufacturer accepts no liability if these instructions are not followed.

Symbols Used

Notice



Troubleshooting

This symbol designates tips that will help you to use your device more effectively and easily.

CAUTION!



Damage to the Device or Loss of Data!

This symbol gives warning of damage to the device and possible loss of data. This damage can result from improper handling.

DANGER!



Danger to Persons!

This symbol gives warning of danger to persons. Physical injury or damage can result from improper handling.

What's in the Box

- 1 – Remote Control
- 2 – PicoPix Projector
- 3 – Power supply
- 4 – USB cable
- 5 – HDMI cable
- 6 – Quick Start Guide
- 7 – Pouch

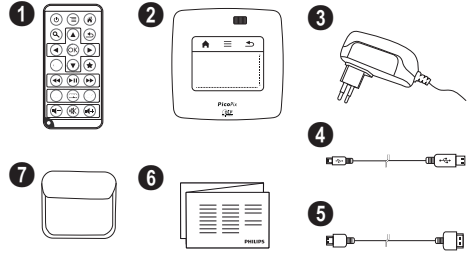

Product Highlights

Connecting to devices with HDMI output

With the HDMI to mini HDMI cable you can connect the projector to a computer or laptop (see also Connect to the Playback Device, page 14).

Directly connecting projector to computer using WLAN (WiFi streaming)

With the software PicoPixWlink you can connect the projector to a computer or a laptop over your wireless network. For this purpose, both devices must be connected to the same wireless network (see also Directly Connecting Projector to Computer using WLAN (WiFi Streaming), page 17).

Office playback (YOZO Office)

You can display documents with YOZO Office (see also Office Playback (YOZO Office), page 25).

I General Safety Information

Do not make any changes or settings that are not described in this user manual. Physical injury or damage to the device or loss of data can result from improper handling. Take note of all warning and safety notes indicated.

Setting up the Device

The unit is for indoor use only. The device should be placed securely on a stable, flat surface. Position all cables in such a way that no one will stumble on them, thus avoiding possible injuries to persons or damage to the device itself.

Do not plug in the device in moist rooms. Never touch the mains cable or the mains connection with wet hands.

The device must have sufficient ventilation and may not be covered. Do not put your device in closed cabinets or boxes.

Do not place the machine on soft surfaces such as tablecloths or carpets and do not cover the ventilation slits. Otherwise the device could overheat or catch fire.

Protect the device against direct sunlight, heat, large temperature fluctuations and moisture. Do not place the device in the vicinity of heaters or air conditioners. Observe the information on temperature and humidity in the technical data.

When the device is running for a long period of time, the surface becomes hot and a warning symbol appears on the projection (see also Symbols in the Statusbar, page 10). The device behaves as follows:

- 1 The fan turns to maximum level.
- 2 At maximum level of brightness the overheat symbol appears in the status bar and the device turns automatically to minimum level of brightness.
- 3 At minimal level of brightness the overheat symbol shows for three seconds in the middle of the screen. Then the device turns off automatically.



After the device has cooled down, you can continue playback.

Do not allow liquids to enter into the device. Switch off the device and disconnect it from the mains supply if liquids or foreign substances end up inside the device. Have the unit inspected by a technical service department.

Always handle the unit with care. Avoid touching the lens. Never place heavy or sharp objects on the projector or the power cable.

If the projector gets too hot or emits smoke, shut it down immediately and unplug the power cable. Arrange for your device to be investigated by a technical service centre. To prevent the spread of fire, open flames should be kept away from the device.

Under the following conditions, a layer of moisture can appear inside the device which can lead to malfunctions:

- if the device is moved from a cold to a warm area;
- after a cold room is heated;
- when this device is placed in a damp room.

Proceed as follows to avoid any moisture build-up:

- 1 Seal this device in a plastic bag before moving it to another room, in order for it to adapt to room conditions.
- 2 Wait one to two hours before you take the device out of the plastic bag.

The device should not be used in a very dusty environment. Dust particles and other foreign objects may damage the unit.

Do not expose the device to extreme vibrations. It may damage the internal components.

Do not allow children to handle the device without supervision. The packing materials should be kept out of the hands of children.

Repairs

Do not repair the device yourself. Improper maintenance can result in injuries or damage to the device. Your device must be repaired by an authorised service centre.

Find details of authorised service centres on the warranty card.

Do not remove the type label from your device; this would void the warranty.

Power Supply

Use only the enclosed power adapter (see chapter Appendix / Technical Data). Check whether the mains voltage of the power supply matches the mains voltage available at the setup location. This equipment complies with the voltage type specified on the unit.

The capacity of the battery diminishes with time. If the device functions only with the power supply, the battery is defective. Contact an authorised service centre to replace the battery.

Do not try to replace the battery yourself. Incorrect handling of the battery or using the wrong type of battery can cause damage to the device or cause injury.

DANGER!



Risk of explosion with incorrect type of batteries

Do not try to replace the battery yourself.

There is a risk of explosion if the incorrect battery type is used.

Switch the device on or off using the power switch before removing the power supply from the socket.

Turn off the device and remove it from the power supply before cleaning the surface. Use a soft, lint-free cloth. Never use liquid, gaseous or easily flammable cleansers (sprays, abrasives, polishes, alcohol). Do not allow any moisture to reach the interior of the device.

DANGER!



High Power LED

This device is equipped with an high power LED (Light Emitting Diode), which emits very bright light. Do not look directly into the projector lens. This could cause eye irritation or damage.

DANGER!



Danger of hearing damage

Do not use the device over a longer time at high volume – especially when using headphones. This could lead to the risks of hearing damage.

Wireless Network (WLAN)

The functioning of security systems, medical equipment or sensitive devices can be disrupted by the transmission power of the device. Observe any usage regulations (or restrictions) in the vicinity of such equipment.

The use of this device can affect the operation of insufficiently shielded medical devices and hearing aids and pacemakers through the release of high frequency radiation. Also consult a doctor or the manufacturer of the medical device to establish whether these are sufficiently shielded from external high frequency radiation.

2 Overview

Top of the Device

- ❶ – Touchpad for navigation and operation of the mouse pointer (see also Touchpad / Gestures, page 7)
- ❷ – LED status bar
Blue: device switched on / device in standby
Off: device off
- ❸ – Focus wheel for image sharpness.

Notice



Note that the distance to the projection surface must be a minimum of 0.5 meters and a maximum of 5 meters. If the Pocket Projector is located outside of this range, it will not be possible to focus the image. Turn the focus wheel carefully so as to avoid damaging the lens.

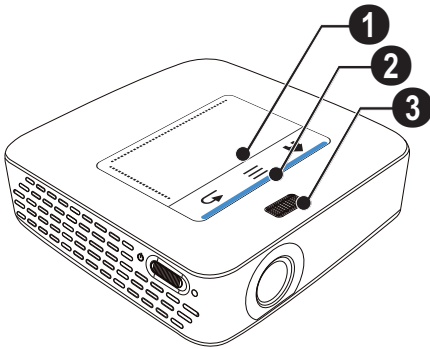

Bottom of the Device

- ❶ – Pico Station connection socket
- ❷ – Tripod socket
- ❸ – Pico Station port

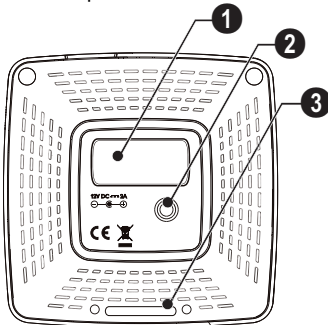

Side View

- ❶ – Reset hole
The Pocket Projector is unresponsive or hung up: insert a slim, pointy object into the reset hole to trigger a hardware reset.
- ❷ – Battery status monitor
Charge indicator with connected power supply:
red: Charging battery
Green: battery is fully charged
- ❸ – On/Off switch
- ❹ A/V – A/V port for a playback device
- ❺ – Remote-control signal receiver
- ❻ – Audio output – headphone connection or connection for external speakers
- ❼ HDMI – HDMI port for a playback device (with adapter cable)
- ❽ SD/MMC – Memory card slot (SD/SDHC/SDXC/ MMC)
- ❾ – USB port for connection to a computer (data exchange)
- ❿ DC IN – Power supply port

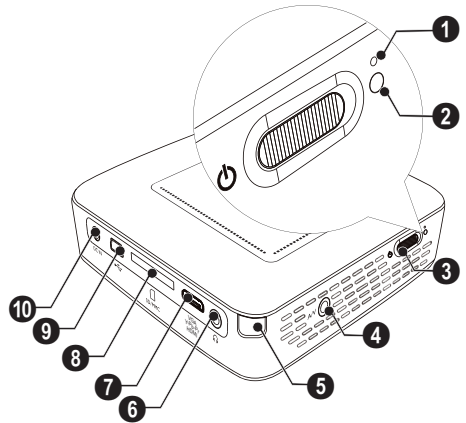

❶ ➔ – USB port for a USB storage medium, DVB-T stick, mouse or keyboard.

❷ – Lens

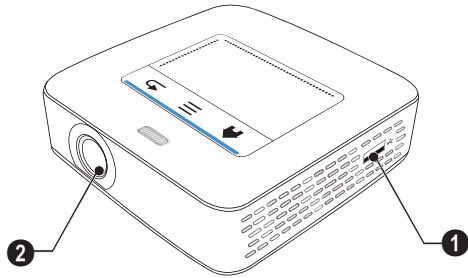

Pico Station

(not included)

The Pico Station docking station has its own battery, with which you can extend the replay time of the device. The inbuilt speakers ensure improved sound quality during playback. The Pico Station has a DVB-T adapter so that you can directly connect a DVB-T adapter.

Available as accessories

Pico Station with battery and speakers
..... PPA7300 / 253529749

Pico Station with battery, speakers and DVB-T adapter
..... PPA7301 / 253532895

Top of the Device

❶ – PicoPix connection socket

❷ – PicoPix port

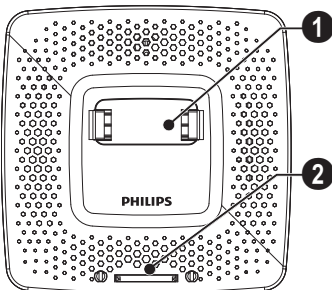

Bottom of the Device

❶ – Tripod socket

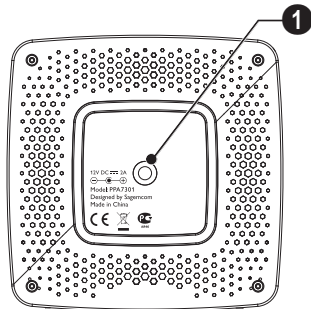

Front View

❶ – PicoPix port

❷ – Eject button

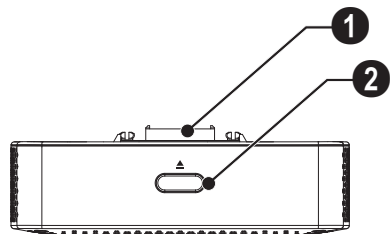

Rear View

❶ DC IN – Power supply port

❷ – Battery status monitor

red: battery empty

Charge indicator with connected power supply:

red: Charging battery

Green: battery is fully charged

❸ ANTENNA – Aerial socket

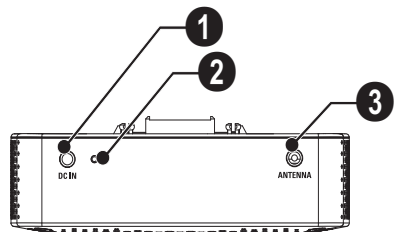

Touchpad / Gestures

The touchpad is a touch-sensitive surface. Touch the touchpad with one or more fingers to move the cursor, navigate in the menu, select menu options or carry out other actions.

CAUTION!



Ballpoint Pens!

Do not use a ball-point pen or other objects to operate the touchpad. Hard and sharp objects may damage the touchpad.

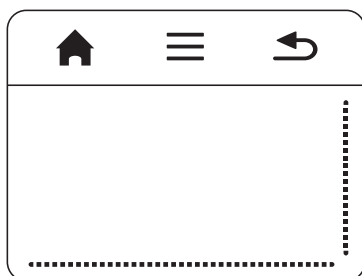

🏠 – Calling the main menu

☰ – Calling the menu

↶ – One menu step back, one directory level back / cancelling functions

Navigation Area / Scrolling Area

Swipe up and down on the right edge of the touchpad to use vertical scroll.

Swipe left and right on the bottom edge of the touchpad to use horizontal scroll.



Input Area

The input area is limited by the navigation area/scrolling area. You can control the cursor using gestures in the input area.



Notice



Hidden Cursor

After a short time, the cursor fades out. Move the cursor using a brief gesture in the input area to reveal the cursor before you call a function by tapping/clicking.

Notice



Connecting a USB Mouse

You can connect a USB mouse to the USB port on the side of the device.

Gestures

Simple gestures, which you carry out on the touchpad for quick navigation. Most gestures are carried out with one or two fingers. Carry out the gestures using your fingertips.

Move cursor – Swipe over the input area, to move the cursor. The gesture involves swiping the surface of the touchpad with the fingertip without exerting any pressure.

Tap / click – Tap briefly in the input area to confirm an entry. After tapping remove your finger from the touchpad. The reaction occurs after you have lifted your finger. The click is executed at the point where the cursor is located, even if the cursor is hidden.

Software Keyboard

- 1 Click in the input field (see also Touchpad / Gestures, page 7) using the touchpad or a mouse.
- 2 The software keyboard appears..

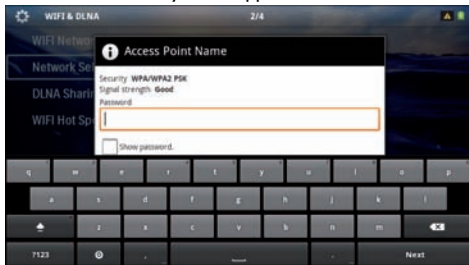

- 3 Using the touchpad or a mouse enter the text on the software keyboard.

Remote Control

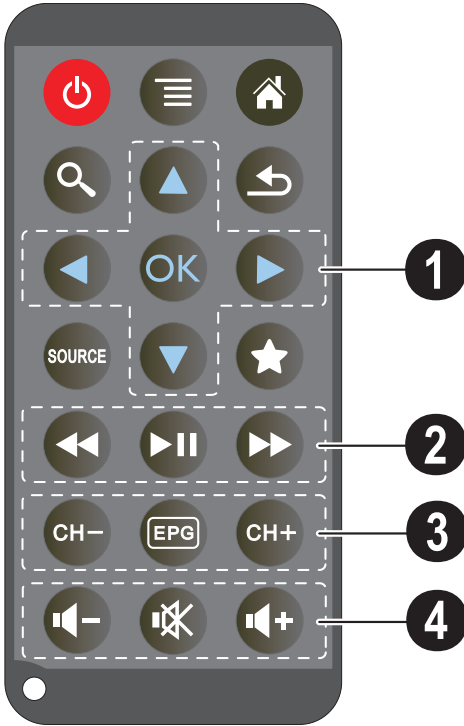

- ⏻ – Switches the device hibernation mode
- ☰ – Call the menu
- 🏠 – Call the main menu
- 🔍 – Call the search menu
- ⏪ – One menu step back, one directory level back / cancelling a function
- 📺 – Switch to the external video input **HDMI, AV, COMPONENT** or **VGA**
- ★ – DVB-T mode: change to favourites

1 Navigation keys

- OK – Confirms selection
- ▲/▼, ◀/▶ – Navigation keys / navigate the menu / modify settings
- ▲/▼ – Modify settings / during music playback select previous, next title
- ◀/▶ – During music playback adjust volume level / during video playback review, cue

2 Playback keys

- ⏮ – Rewind
- ⏸ – Start / stop playback
- ⏭ – Fast-forward

3 DVB-T keys

- CH- – Select previous channel
- EPG – Call electronic program guide
- CH+ – Select the next channel

4 Volume keys

- 🔊- – Decrease the volume
- 🔇 – Mute the sound
- 🔊+ – Increase the volume

Overview of the Menu Functions

- 1 After switching on the device the main menu appears.
- 2 Select the desired menu using the navigation keys (◀/▶).
- 3 Confirm with (OK).
- 4 By pressing the (⏮) key you will return to the main menu.



Source – Switch to the external video input **HDMI, AV, COMPONENT** or **VGA**

Videos – Selecting files for video playback

Pictures – Selecting files for the slideshow

Music – Selecting music files for playback

Android – Call the android operating system

Settings – Configure settings for playback and for the device

Folder View – Selecting files for Playback. Copy or Delete Files (Mark the files with (▶) and confirm using (OK)).

Digital TV – Television

Symbols in the Statusbar

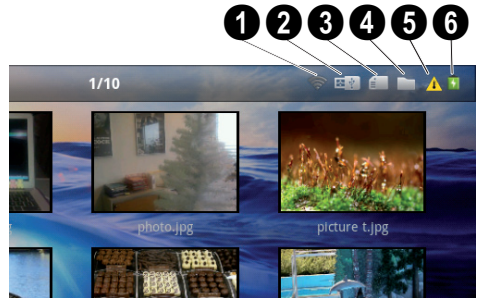

① – WLAN status display

② – USB storage medium

③ – Memory card

④ – Internal memory

⑤ – Overheat symbol

⑥ – Charge level of the internal battery. The icon will be red, when the battery needs to be recharged.

3 Initial Operation

Setting up the Device

You can position the device so that it lies flat on a table in front of the projection surface; it is not necessary to tilt it towards the projection surface. The device compensates for the distortion from the slanted projection (pincushion distortion).

Connect Power Supply / Charge Battery

CAUTION!



Mains Voltage at the Site of Installation!

Check whether the mains voltage of the power supply matches the mains voltage available at the setup location.

- 1 Insert the small plug of the power supply into the socket on the rear side of your device.
- 2 Plug the power supply into the mains.
- 3 During the charging process, the indicator light on the side of the device will be red. When the battery is fully charged, it will turn green.
- 4 Charge the built-in battery completely before using for the first time. This will prolong the life of the battery.

AC 100~240V

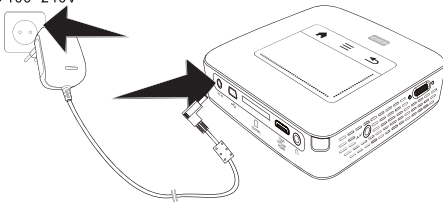

Notice



Pico Station

The battery of the Pico Station will not be charged while the projector is in use.

Notice



Charging via Pico Station

The battery of the projector will not be charged while the projector is in use.

Notice



Operate via Pico Station

The battery of the Pocket Projector is empty: Connect the Pico Station to use the Pocket Projector.

Notice



Battery Empty

The battery of the Pocket Projector is empty: Connect the Pico Station or the power supply to use the Pocket Projector.

Connect the power supply to the Pocket Projector or the Pico Station to recharge the battery.

Disconnect the power supply only if the Pocket Projector is sufficiently charged. Otherwise the Pocket Projector turns off.

Installing or Changing the Batteries of the Remote Control

DANGER!



Risk of Explosion with Incorrect Type of Batteries

Only use the CR 2025 type battery.

There is a risk of explosion if the incorrect battery type is used.

- 1 To access the battery, disengage the locking mechanism (1) and slide out the battery compartment (2).

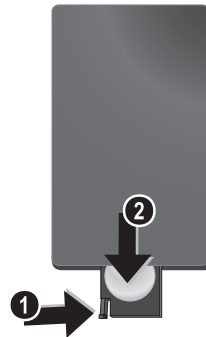

- 2 Insert the new batteries into the battery compartment with the positive and negative poles as shown on the back of the remote control. Make sure the polarities(+ and -) are aligned correctly.



- 3 Push the battery compartment back into the remote control until the locking mechanism engages.



Notice



Normally the batteries will last for around one year. If the remote control stops working, please replace the batteries. If the device is not used for a long time, take out the batteries. This will prevent leakage and possible damage to the remote control.

The used batteries should be disposed of according to the recycling regulations of your country.

Using the Remote Control

Point the remote control at the remote sensor on the back of the device. The remote can be used within an angle of 60 degrees and up to 5 meters from the device. When using the remote control, no obstacle should be placed between the remote control and remote sensor.



CAUTION!

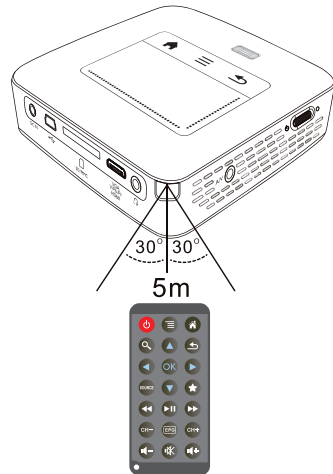

- The improper use of batteries can lead to overheating, explosion, risk of fire and injury. Leaking batteries can possibly damage the remote control.
- Never expose the remote control to direct sunlight.
- Avoid deforming, dismantling or charging the batteries.
- Avoid exposure to open fire and water.
- Replace empty batteries immediately.
- Remove the battery from the remote control if not in use for long periods of time.



Initial Installation









- 1 Push for about 3 seconds the on/off switch on the side to turn the device on.
- 2 Turn the device towards a suitable projection surface or wall. Note that the distance to the projection surface must be a minimum of 0.5 meters and a maximum of 5 meters. Make sure the projector is in a secure position.
- 3 Use the focus wheel on the top to adjust the image sharpness.
- 4 Select the desired menu language using /.
- 5 Confirm with .

Notice



The Main Menu Appears Instead of the Language Selection

The device has already been installed. In order to change the menu language, proceed as follows:

- 1 Use the navigation keys to select **Settings**.
- 2 Confirm with .
- 3 Select with / **Language**.
- 4 Confirm with .
- 5 Select the desired language with /.
- 6 Confirm with .
- 7 Exit with .

4 Connect to the Playback Device

Only use the supplied cable or cables that are available as accessories to connect the projector.

Supplied cables

- HDMI cable
- USB cable

Cables available as accessories

- Component Video Cable YUV / YPbPr (PPA1210 / 253447083)
- Video-(CVBS) cable (PPA1320 / 253526178)
- VGA cable (PPA1250 / 253447070)
- iPhone/iPad/iPod-HDMI cable . (PPA1280 / 253447091)
- iPhone/iPad/iPod-A/V cable..... (PPA1160 / 253372471)
- MHL cable..... (PPA1240 / 253520048)

Connecting to Devices with HDMI Output

Use the HDMI to mini HDMI cable to connect the projector to a computer or laptop.

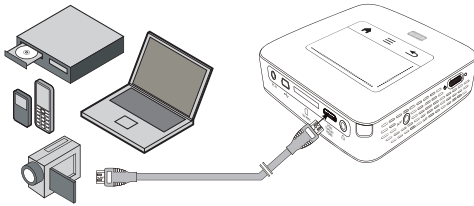

- 1 Switch the device on using the on/off switch on the side.
- 2 After the initial screen the main menu appears.

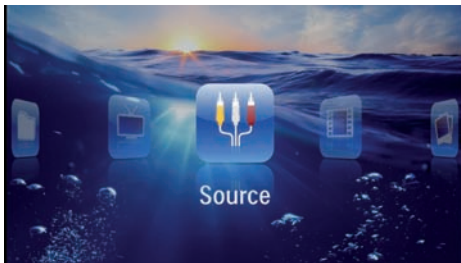

- 3 Select **Menu > Source** and switch to **HDMI**.
- 4 Connect the HDMI cable to the projector's **HDMI** socket.
- 5 Connect the cable to the mini-HDMI socket of the playback device.

Connecting to an iPhone/iPad/iPod

Use the iPhone/iPad/iPod-HDMI cable (not supplied) to connect the projector to an iPhone/iPad/iPod.

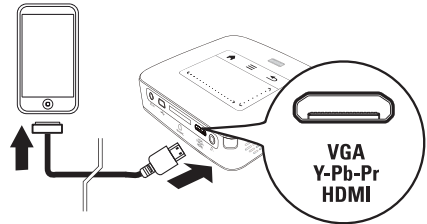

- 1 Select **Menu > Source** and switch to **Component**.
- 2 Connect the cable to the projector's **HDMI** socket.
- 3 Connect the cable to the playback device.

Supported devices

All devices with 30-pin dock connector are supported.

| Device | Generation |
|------------|--------------------|
| iPod nano | up to generation 6 |
| iPod touch | up to generation 4 |
| iPhone | up to generation 4 |
| iPad | up to generation 2 |

Connecting to Smartphone

Use the HML cable (not supplied) to connect the projector to a smartphone.

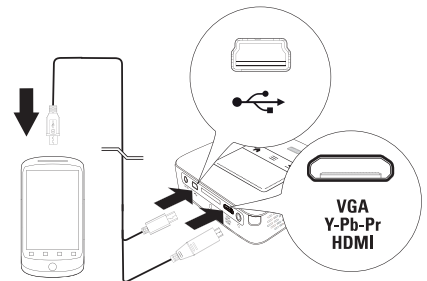

- 1 Select **Menu > Source** and switch to **HDMI**.
- 2 Connect the cable to the projector's **HDMI** and **+** sockets.
- 3 Connect the cable to the playback device.

Connecting to a Computer (VGA)

Notice



Many laptops do not activate the external video output automatically when you connect a second display such as a projector. Check your laptop's manual to find out how to activate the external video output.

Use the VGA cable (not included) to connect the projector to a computer, laptop, or some PDAs. The projector supports the following resolutions: VGA/SVGA/XGA. For best results, set the computer's resolution to SVGA (800x600).

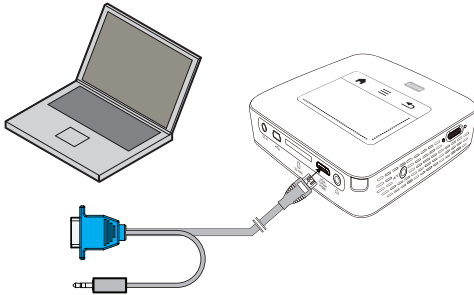

- 1 Connect the VGA cable to the projector's **HDMI** socket.
- 2 Connect the VGA plug to the VGA socket of the computer and the audio plug to the computer's audio output.
- 3 Adjust the computer's resolution to the correct setting and switch the VGA signal to an external monitor. The following resolutions are supported:

| | Resolution | Image refresh rate |
|---------|-------------|--------------------|
| VGA | 640 x 480 | 60 Hz |
| SVGA | 800 x 600 | 60 Hz |
| XGA | 1024 x 768 | 60 Hz |
| WXGA | 1280 x 768 | 60 Hz |
| FULL HD | 1920 x 1080 | 60 Hz |

Notice



Screen Resolution

You can obtain the best results with the 800 x 600 (60Hz) resolution.

- 4 Select **Menu > Source** and switch to **VGA**.

Connecting Using an Audio/Video (CVBS) Adapter Cable

Use the projector's audio/video adapter cable (A/V cable) (not included) to connect camcorders, DVD players or digital cameras. The jacks for these devices are yellow (video), red (audio right) and white (audio left).

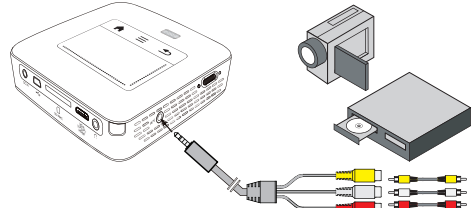

- 1 Connect the supplied A/V cable to the **AV** socket of the projector.
- 2 Connect the video device's audio/video sockets to the A/V cable using a conventional composite video (RCA) cable.
- 3 Select **Menu > Source** and switch to **AV**.

Connecting to mobile multimedia devices

Some video devices (e.g.: pocket multimedia players, ...) require specific connection cables. There are either supplied with the device or acquired from the manufacturer of the multimedia device. Please note that only the original cables from the device manufacturer may function.

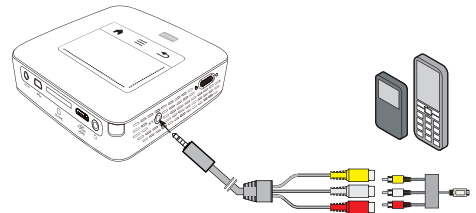

Notice



Switching to the Multimedia Device Signal Output

See the multimedia device instruction manual to find out how to switch the signal output to this jack.

Connecting using Component-Video (YPbPr/ YUV) Cable

Please use this type of connection to obtain the highest possible image quality. This cable is available as an accessory. The device jacks have the colours green (Y), blue (U/Pb), red (V/Pr) for the video signal and red (audio right) and white (audio left) for the audio signal.

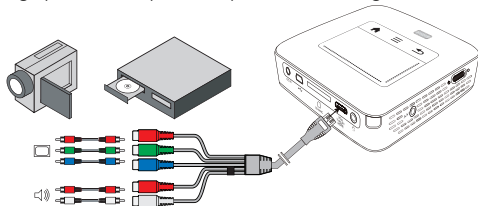

- 1 Connect the video component cable (accessory) to the projector's **HDMI** socket.
- 2 Connect the video device's appropriate coloured sockets to the component video cable of the projector using a conventional component video (RCA) cable.

Notice



YCbCr

Note that the **YPbPr** outlets are labelled **YCbCr** on some devices.

Notice



Two Red Phono (RCA) Connectors

When connecting, note that there are two red phono (RCA) connectors on the cable. One is for the right audio signal and the other for the V/Pr element of the component video signal. If these two connectors are inserted incorrectly, the projected image appears green and the audio signal for the right speaker will not work.

- 3 Select **Menu > Source** and switch to **Component**.

Connecting to mobile multimedia devices

Some video devices (e.g.: pocket multimedia players, ...) require specific connection cables. There are either supplied with the device or acquired from the manufacturer of the multimedia device. Please note that only the original cables from the device manufacturer may function.

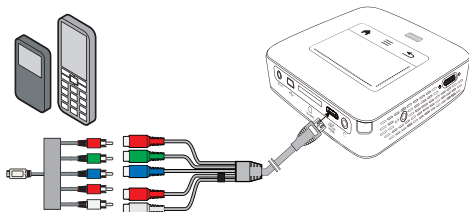

Notice



Switching to the Multimedia Device Signal Output

See the multimedia device instruction manual to find out how to switch the signal output to this jack.

Directly Connecting Projector to Computer using WLAN (WiFi Streaming)

With the software PicoPixWlink you can connect the projector to a computer or a laptop over your wireless network. For this purpose, both devices must be connected to the same wireless network.

- 1 Install the PicoPixWlink software (already pre installed on the projector) on your computer (see also Connect to a Computer (USB), page 19).
- 2 Connect the device with the wireless network (see also Wireless Network (WLAN), page 20).
- 3 Start PicoPixWlink (PicoPix Viewer) on your computer.
- 4 Click the PicoPixWlink icon in the notification area and start the manager window.

You are now able to search for projectors in the network (Search WIFI projector) and start the projection (Start projection).

Connecting the headphones

- 1 Before connecting the headphones, turn down the volume on the device.
- 2 Connect the headphones to the projector's headphone slot. The device speakers deactivate automatically when the headphones are connected.

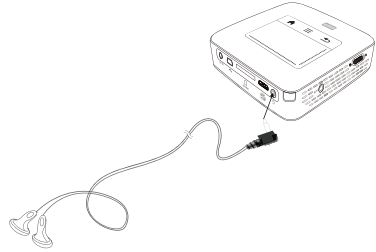

- 3 After connecting the headphones, increase the volume to a comfortable level.

DANGER!



Danger of Hearing Damage

Do not use the device over a longer time at high volume – especially when using headphones. This could lead to the risks of hearing damage. Before connecting the headphones, turn down the volume on the device. After connecting the headphones, increase the volume to a comfortable level.

5 Memory

Inserting a Memory Card

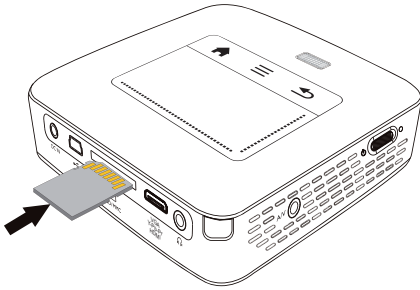

- 1 Insert a memory card with the contacts facing upwards into the **SD/MMC** slot at the back of the device. Your device supports the following memory cards: SD/SDHC/SDXC/MMC.
- 2 Insert the memory card into the slot until it snaps into position.

DANGER!



Inserting a Memory Card!

Never pull out the memory card while the device is accessing it. This could cause data to be damaged or lost.

Switch the device off in order to make sure that the device does not access the memory card.

- 3 Press lightly on the memory card to remove it.
- 4 The memory card is ejected.

Connecting USB Storage Medium

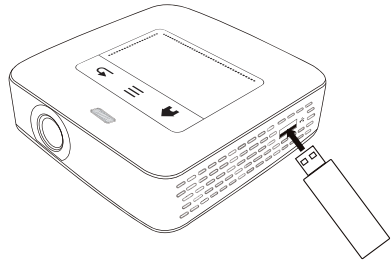

- 1 Connect the USB storage medium to the USB port on the side of the device.

Connect to a Computer (USB)

You can use the USB cable to connect the Pocket Projector to a computer. In this way, you are able to copy files back and forth between the internal memory, an inserted memory card and the computer. You can also delete the files. You can playback the files saved on the Pocket Projector on your computer.

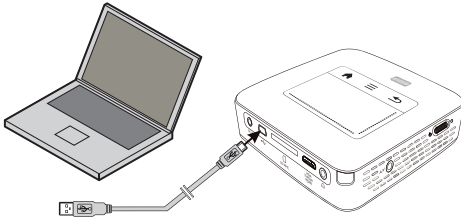

- 1 Switch the device on using the on/off switch on the side.
- 2 After the initial screen the main menu appears.

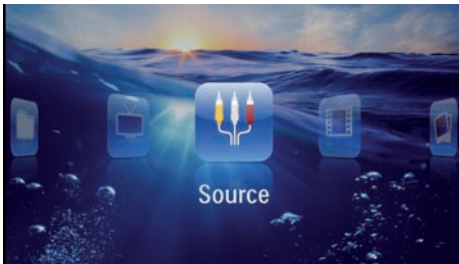

- 3 Connect the mini-USB port to the Pocket Projector and the USB socket to the computer.
- 4 A confirmation screen appears when the devices are connected successfully.

- 5 Confirm to enable the connection.



Notice



Successful Connection

You cannot use the memory for media playback when the Pocket Projector is connected to a computer via USB. Use WiFi Streaming instead (see also Directly Connecting Projector to Computer using WLAN (WiFi Streaming), page 17).

- 6 If a memory card has been inserted, it will be displayed as another disk drive.
- 7 You can move, copy or delete data from the computer, the memory card (if inserted) and the internal memory.

6 Wireless Network (WLAN)

In a wireless network (Wireless Local Area Network, WLAN) at least two computers, printers or other additional devices communicate with each other over radio waves (high frequency waves). Data transmission in the radio network is based on the standards 802.11b, 802.11g and 802.11n.

DANGER!



Information on Using WLAN!

The functioning of security systems, medical equipment or sensitive devices can be disrupted by the transmission power of the device. Observe any usage regulations (or restrictions) in the vicinity of such equipment.

The use of this device can affect the operation of insufficiently shielded medical devices and hearing aids and pacemakers through the release of high frequency radiation. Also consult a doctor or the manufacturer of the medical device to establish whether these are sufficiently shielded from external high frequency radiation.

Infrastructure Wireless Network

In an infrastructure network, multiple devices communicate via a central access point (gateway, router). All data are sent to the access point (gateway, router) and distributed from there.

Switching Wireless Networking (WLAN) on/off

Wireless networking is deactivated by default. You have the option of turning this function on.

- 1 Switch the device on using the on/off switch on the side.
- 2 After the initial screen the main menu appears.

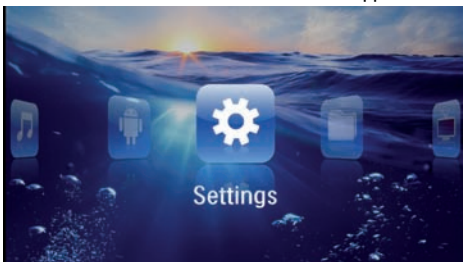

- 3 Use the navigation keys to select **Settings**.
- 4 Confirm with **OK**.
- 5 Using **▲/▼** select **WIFI & DLNA**.
- 6 Confirm with **OK**.
- 7 Using **▲/▼** select **WIFI Network**.
- 8 Confirm with **OK**.

- 9 Modify the settings with **▲/▼**.

- 10 Confirm with **OK**.

The **⏪** key takes you one step back in the menu.

Setting up a Wireless Network (WLAN)

- 1 Switch the device on using the on/off switch on the side.
- 2 After the initial screen the main menu appears.

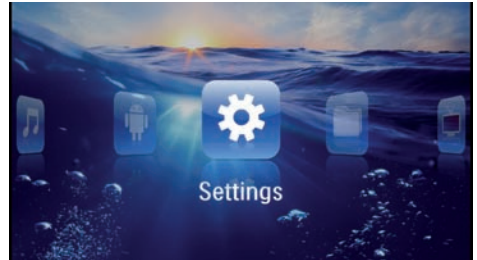

- 3 Use the navigation keys to select **Settings**.

- 4 Confirm with **OK**.

- 5 Using **▲/▼** select **WIFI & DLNA**.

- 6 Confirm with **OK**.

- 7 Using **▲/▼** select **Network Selection**.

- 8 Confirm with **OK**.

- 9 Use **▲/▼** to select the desired wireless network..

- 10 Confirm with **OK**.

11 If your wireless network is password protected, an input window appears. Click in the input field (see also Touchpad / Gestures, page 7) using the touchpad or a mouse.

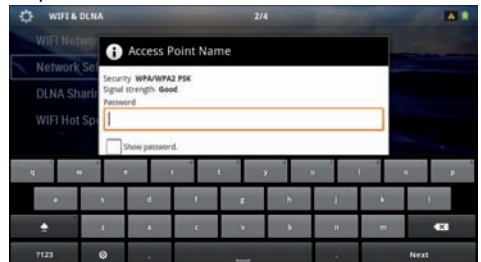

- 12 Using the touchpad or a mouse enter the password on the software keyboard.

- 13 Click on **Connect**.

The **⏪** key takes you one step back in the menu.

Setting up a Wireless Network (WLAN) Using the Wizard

You can integrate your device very quickly and easily into an existing wireless network using Wi-Fi Protected Setup (WPS) or using a wireless network scan. Using WPS, all important settings like network name (SSID) are automatically configured and the connection protected with secure WPA Encryption.

Using Wi-Fi Protected Set-up (WPS)

Using Wi-Fi Protected Setup (WPS), you can integrate your device into an existing wireless network in two different ways very quickly and easily. You can activate the login with a pin code or using Push Button Configuration (PBC), if your access point (Access Point, Router) supports this method.

Using WPS with Push Button Configuration (PBC)

- 1 Switch the device on using the on/off switch on the side.
- 2 After the initial screen the main menu appears.

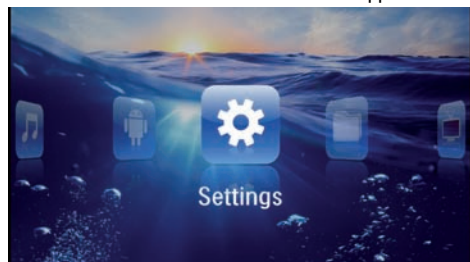

- 3 Use the navigation keys to select **Settings**.
- 4 Confirm with **OK**.
- 5 Using **▲/▼** select **WIFI & DLNA**.
- 6 Confirm with **OK**.
- 7 Using **▲/▼** select **Network Selection**.
- 8 Confirm with **OK**.
- 9 Use **▲/▼** to select the desired wireless network..
- 10 Confirm with **OK**.
- 11 Activate Push Button Configuration on the WLAN access point. The WLAN access point and device connect automatically and create a WPA protected connection.

Digital Living Network Alliance (DLNA)

This device supports Digital Living Network Alliance (DLNA). Using this standard you can quickly interconnect your multimedia devices.

Switching DLNA on and off

The DLNA function is switched on by default. You have the option of turning this function off.

- 1 Switch the device on using the on/off switch on the side.
- 2 After the initial screen the main menu appears.

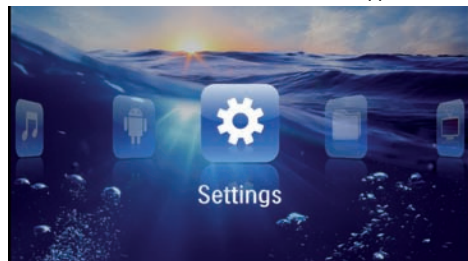

- 3 Use the navigation keys to select **Settings**.
 - 4 Confirm with **OK**.
 - 5 Using **▲/▼** select **WIFI & DLNA**.
 - 6 Confirm with **OK**.
 - 7 Using **▲/▼** select **DLNA Sharing**.
 - 8 Confirm with **OK**.
 - 9 Modify the settings with **▲/▼**.
 - 10 Confirm with **OK**.
- The **⏪** key takes you one step back in the menu.

Play Media Using DLNA

If DLNA enabled devices are located in the connected network, then you can access them in media playback and file management (see also Media Playback, page 22).

DLNA Control

You can control the projector using another device (e.g. a smartphone) using DLNA. To do this, see the instruction manual for the device in question.

7 Media Playback

Notice



Navigation Keys

All the keys shown are buttons on the remote control.

Notice



Best Settings for Optimal Use

Read the informations on the best settings in the chapter settings (see also Settings, page 34) for optimal use of your device.

Video playback

Video Playback (USB/SD Card/Internal Memory/DLNA)

- 1 Switch the device on using the on/off switch on the side.
- 2 After the initial screen the main menu appears.

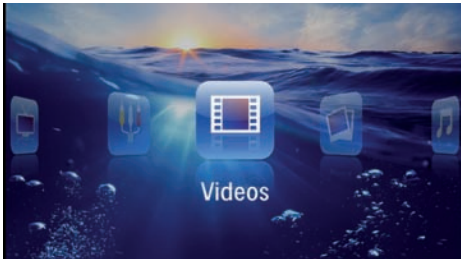

- 3 Use the navigation keys to select **Videos**.
- 4 Confirm with **OK**.
- 5 **With connected memory:** Using the keys **▲**/**▼** select the internal memory, a DLNA device, the USB storage medium or the memory card.
- 6 Confirm with **OK**.

- 7 Use **▲**/**▼** to select the video file that you wish to play.

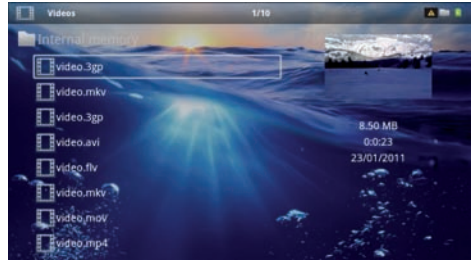

Notice



Displaying Video Files

Only those videos that are compatible with the Pocket Projector will be displayed.

- 8 Press **OK** to start playback.
- 9 Press **⏪** to end the slide show and return to the overview.
- 10 When you press **⏩** again, you will return to the main menu.

Notice



Navigation During Playback

Review / cue: Press **⏮**/**⏭** on the remote control or **⏮**/**⏭** on the device.

Press **⏸** to stop or continue playback.

During playback you can adjust the volume using **⏮**/**⏭** on the remote control. Press **⏸** or **⏮** repeatedly to shut off the volume completely.

File Format

There are various video file formats as *.mov, *.avi, *.m4v. Many of these formats function as a container that contains the various encoded audio and video files. MPEG-4, H.264, MP3, and AAC are all examples of encoded audio/video files. In order to play these files, the projector must read them and decode the audio/video signals.

Please note that some files cannot be played as a result of different video and audio encoders.

Supported file formats

| Container | Video format |
|---------------------|----------------------|
| *.avi, *.mov, *.mp4 | MJPEG, MPEG-4, H.264 |
| *.mkv | MPEG-4, H.264 |
| *.ts | MPEG-2, H.264 |
| *.m2ts | H.264 |
| *.3gp | H.263 |
| *.rm, *.rmvb | Real video |
| *.dat | MPEG-1 |
| *.vob | MPEG-2 |
| *.mpg, *.mpeg | MPEG-1, MPEG-2 |

Video Playback (Mini-HDMI Socket)

- 1 Connect the audio/video output of the external device to the Pocket Projector's **HDMI** socket. Use the corresponding cable and cable adapter for this purpose (see also **Connect to the Playback Device**, page 14).
- 2 To find out how to deactivate the video output for the external device, please see the relevant instruction manual. Most often, this option is labelled "TV out" or "TV Output" in the corresponding menu.
- 3 Start the video playback on the external device.
- 4 Modify the volume with \odot / \oplus .

Modify settings during playback

- 1 Press the \uparrow or \downarrow key.
- 2 Use the \uparrow / \downarrow keys to choose from the following settings:
 - Volume:** Adjust volume level
 - Smart Settings:** Select predefined settings for brightness / contrast / colour saturation
 - Saturation:** Adjust colour saturation
 - Contrast:** Adjust contrast
 - Brightness:** Adjust brightness
- 3 Modify the setting using \odot / \oplus .

The device saves the modified settings automatically.

Photo Playback

- 1 Switch the device on using the on/off switch on the side.
- 2 After the initial screen the main menu appears.

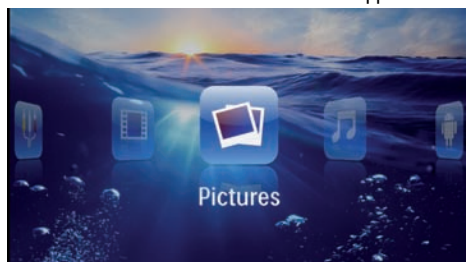

- 3 Use the navigation keys to select **Pictures**.
- 4 Confirm with \odot .
- 5 **With connected memory:** Using the keys \uparrow / \downarrow select the internal memory, a DLNA device, the USB storage medium or the memory card.
- 6 Confirm with \odot .
- 7 Miniature photos are displayed on the screen as an overview.



Notice



Miniature View or List

In the settings, you are able to select whether the overview will be displayed as miniatures or in a list.

Notice



Many Photos on the Memory Card or the USB Medium

If there are a lot of photos on the memory card or the USB storage medium it can take a moment before the overview appears.

- 8 Use \leftarrow / \rightarrow or \uparrow / \downarrow to select the image that you want to start the slide show with.
- 9 Press \odot to start the slide show.

Notice



Rotate the Image

Using your thumb contact the touchpad and swipe with the forefinger in a circular manner to rotate an image (see also Touchpad / Gestures, page 7).

- 10 Press to pause the slide show.
- 11 Press to end the slide show and return to the overview.
- 12 When you press again, you will return to the main menu.

Slide Show with Background Sound

- 1 Start the slideshow.
- 2 Press , to open the menu bar.
- 3 Using select .
- 4 Confirm with .
- 5 Use to select the file that you wish to play.

Notice



Storage Location

Only files from the internal memory/Memory Card/USB Storage Medium can be played.

- 6 To start the background sound confirm with .
- 7 Press to adjust the volume level.
- 8 If no input is made, the menu bar is hidden after 5 seconds.

Music Playback

Notice



Switch off the Image Playback

You can turn off image playback while playing music in order to save power (see also Music settings, page 34). As soon as you press the key, the image reappears and the fan starts again.

- 1 Switch the device on using the on/off switch on the side.
- 2 After the initial screen the main menu appears.

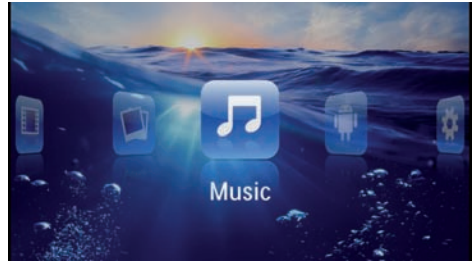

- 3 Use the navigation keys to select **Music**.
- 4 Confirm with .
- 5 **With connected memory:** Using the keys select the internal memory, a DLNA device, the USB storage medium or the memory card.
- 6 Confirm with .
- 7 Use to select the file that you wish to play.



- 8 Press to start playback.
- 9 Press to stop or continue playback.

Notice



Navigating when Image Playback is Switched off

- Press to skip to the previous or next song.
- Press to stop or continue playback.
- Press to return to the selection.

During playback you can adjust the volume using on the remote control. Press or repeatedly to shut off the volume completely.

Notice



Touchpad / Gestures

Swipe left and right on the bottom edge of the touchpad to adjust the volume.

Swipe over the touchpad with two fingers to rewind and fast forward (see also Touchpad / Gestures, page 7).

Office Playback (YOZO Office)

You can display documents with YOZO Office.

- 1 Switch the device on using the on/off switch on the side.
- 2 After the initial screen the main menu appears.



- 3 Use the navigation keys to select **Folder View**.
- 4 Confirm with **OK**.
- 5 **With an inserted memory card or USB storage device:** Select the internal memory, the USB storage medium or the memory card using the keys **▲/▼**.
- 6 Confirm with **OK**.
- 7 Use **▲/▼** to select the file that you want to display.



- 8 Press **OK** to start the display.
- 9 Swipe up and down on the right edge of the touchpad to scroll. Use the touchpad or a mouse to zoom in / zoom out the document (see also Touchpad / Gestures, page 7).
- 10 Press **⊞** to end the display and return to the overview.

Managing Files

Copy Files

You can copy files back and forth from the internal memory to the connected USB storage medium or memory card.

- 1 Switch the device on using the on/off switch on the side.
- 2 After the initial screen the main menu appears.



- 3 Use the navigation keys to select **Folder View**.
- 4 Confirm with **OK**.
- 5 **With an inserted memory card or USB storage device:** Select the internal memory, the USB storage medium or the memory card using the keys **▲/▼**.
- 6 Confirm with **OK**.
- 7 Use **▲/▼** to select the file that you want to copy.

Notice



No Files Found (0 files)

Only those files that are compatible with the Projector will be displayed.

- 8 Mark the file using **▶**. Pressing the key again deselects the chose file(s).

Notice



Mark the Entire Folder

You can also mark an entire folder to copy all files from the folder. Note that the copy process of large folders can takes some time.

- 9 Use **▲/▼** to select other files.
- 10 Press **OK**.
- 11 Select with **▲/▼** **Copy**.

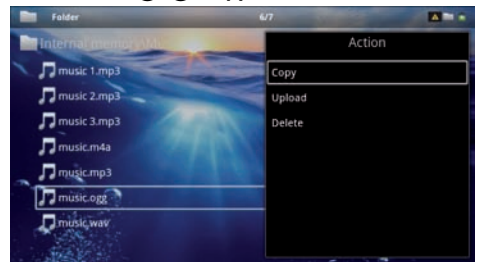

- 12 Confirm with **OK**.

13 Use ▲/▼ to select the destination memory: **SD card, internal memory** or **USB storage medium**.

14 Confirm with OK.

Notice



Files Already Exist

If the files you are copying already exist in the target folder, you must choose whether or not you want to overwrite them using ▲/▼ and OK. If you choose not to overwrite these files, copies will be created. The copies can be recognised by a number added to the file names.

15 The files are copied.

Notice



Error

If errors occur during the copying process, make sure that enough free space is available on the medium.

Notice



Removing Storage Medium

Only remove the storage medium after the copy process is complete.

Delete Files

You can delete files from the internal memory, the connected USB storage medium or the memory card.

- 1 Switch the device on using the on/off switch on the side.
- 2 After the initial screen the main menu appears.

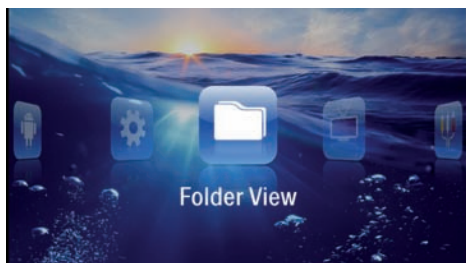

3 Use the navigation keys to select **Folder View**.

4 Confirm with OK.

5 **With connected memory:** Using the keys ▲/▼ select the internal memory, a DLNA device, the USB storage medium or the memory card.

6 Confirm with OK.

7 Use ▲/▼ to select the file that you want to delete.

Notice



No Files Found (0 files)

Only those files that are compatible with the Projector will be displayed.

8 Mark the file using ►. Pressing the key again deselects the chose file(s).

9 Use ▲/▼ to select other files.

10 Press OK.

11 Select with ▲/▼ **Delete**.

12 Confirm with OK.

13 Use ▲/▼ if you want to delete the files or cancel the deletion process.

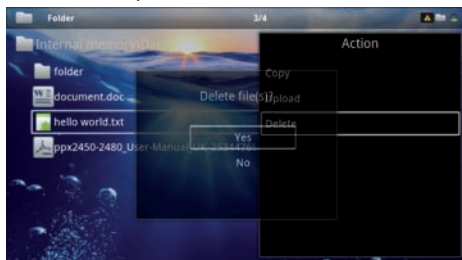

14 Confirm with OK.

Notice



Error

If errors occur during the deletion process, make sure that the storage medium is not write-protected.

Notice



Deleting Photos on the Memory Card

When deleting photos via the computer, note that the photos may not be correctly displayed when the memory card is inserted into the digital camera again. Digital cameras sometimes store additional information in specific folders, including previews and orientation information.

For this reason, only delete the photos using the digital camera.

8 Digital TV Playback

Notice



Necessary Accessories

To be able to use the DVB-T function of your projector, you either require the Pico Station PPA7301 (not supplied) or the USB DVB-T stick PPA8301 (not supplied).

You can purchase the Pico Station docking station and the USB DVB-T stick according to the ordersheet.

Connecting the Aerial

Notice



Aerial Size and Orientation

In some regions it is necessary to connect a larger aerial in order to grant the reception.

In some countries it is necessary to point the aerial horizontally in order to grant the reception.

Connecting the Aerial to the Pico Station PPA7301

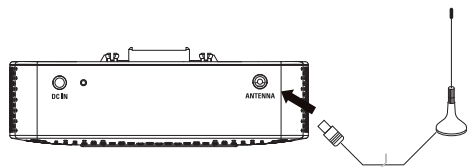

- 1 Connect the aerial to the aerial socket.

Notice



Standard Definition Television

The Pico Station PPA7301 supports Standard Definition Television (SDTV). High Definition Television (HDTV) is not supported.

Connecting the Aerial to the USB DVB-T Stick PPA8301

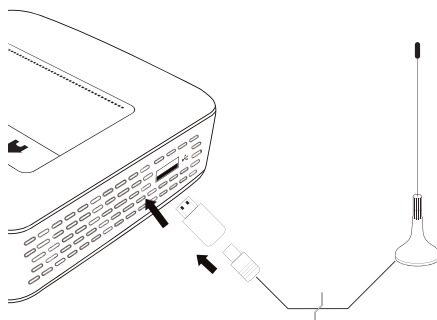

- 1 Connect the USB-DVB-T stick to the USB port on the side of your projector.
- 2 Connect the aerial to the USB-DVB-T stick.

Notice



Standard Definition Television

The Pico Station USB-DVB-T Stick PPA8301 supports Standard Definition Television (SDTV). High Definition Television (HDTV) is not supported.

CAUTION!



Do not Remove DVB-T Stick During Playback!

Do not pull out the DVB-T stick from the device or remove the device from the Pico Station (PPA7301) while you have accessed the DVB sub menu. Preset channels may get lost. Exit the DVB sub menu before pulling out the DVB-T stick of the device or remove the device from the Pico Station (PPA7301).

If the DVB-T stick is being removed during playback you may have to restart the device.

First Playback

Notice



Navigation Keys

All the keys shown are buttons on the remote control.

When the DVB-T function is first started, the automatic channel search must be started.

- 1 Switch the device on using the on/off switch on the side.
- 2 After the initial screen the main menu appears.



- 3 Connect the aerial (see also Connecting the Aerial, page 27).
- 4 Use the navigation keys to select **Digital TV**.
- 5 Confirm with **OK**.
- 6 The sub menu appears.

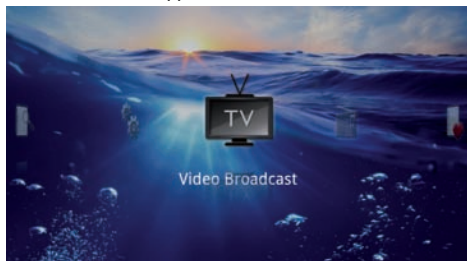

Set Area

- 7 Use the navigation keys to select **Utilities/Setup**.
- 8 Confirm with **OK**.
- 9 Use the navigation keys to select **Area set**.
- 10 Confirm with **OK**.
- 11 Use the navigation keys to select your area.
- 12 Confirm with **OK**.
- 13 Press **Return** to end the sub menu and return to the overview.

Scan Channels

- 14 Use the navigation keys to select **Scan Channels**.
- 15 Confirm with **OK**.
- 16 Use the navigation keys to select **OK**.
- 17 Confirm with **OK**.
- 18 Use the navigation keys to select **Auto**.
- 19 Confirm with **OK**.

Television

- 20 Use the navigation keys to select **Video Broadcast**.
- 21 Confirm with **OK**.
- 22 Change the channel using **CH-/CH+**.

Notice



Displaying Channel Information

When changing channel, channel information is displayed on the bottom projection edge. The information bar is hidden after 5 seconds.

- 23 Press **Stop** to end playback and return to the main menu.

During playback you can adjust the volume using **Volume Up/Down** on the remote control. Press **Mute** or **Volume Down** repeatedly to shut off the volume completely.

Television

Notice



Navigation Keys

All the keys shown are buttons on the remote control.

- 1 Switch the device on using the on/off switch on the side.
- 2 After the initial screen the main menu appears.



- 3 Connect the aerial (see also Connecting the Aerial, page 27).
- 4 Use the navigation keys to select **Digital TV**.
- 5 Confirm with **OK**.
- 6 The sub menu appears.



- 7 Use the navigation keys to select **Video Broadcast**.
- 8 Confirm with **OK**.
- 9 The last viewed channel is played. Change the channel using **CH-**/**CH+**.

Notice



Displaying Channel Information

When changing channel, channel information is displayed on the bottom projection edge. The information bar is hidden after 5 seconds.

- 10 Press **⏏** to end playback and return to the main menu.

During playback you can adjust the volume using **⏮**/**⏭** on the remote control. Press **⏏** or **⏮** repeatedly to shut off the volume completely.

9 Android

Your Pocket Projector uses the Android operating system.

Calling Android

- 1 Switch the device on using the on/off switch on the side.
- 2 After the initial screen the main menu appears.



- 3 Use the navigation keys to select **Android**.
- 4 Confirm with **OK**.

Exiting Android

Press the **↶** key to return to the main menu.
Software Reset

Resetting Android

If your Pocket Projector does not work properly, a reset to factory defaults may solve the problem in many cases.

DANGER!

 **All Settings and Data Will be Deleted!**

This procedure erases all your settings and data that is stored on the device.

Apps need to be reinstalled.

Notice

-  **YOZO Office**
- By resetting Android YOZO Office will be deleted. The reinstallation of YOZO Office will start automatically when connecting the device to the internet via WiFi.

Installing Android-Apps

CAUTION!



Trusted Sources!

Apps from third party sources may be malicious. Only use installation packets from trusted sources.

You can install other apps. Use the APK installation packets.

Notice



Compatibility

The manufacturer does not guarantee the compatibility of third party apps.

Notice



Volume

In some apps, the volume may only be controlled via the remote control.

Notice



Youtube

You need to install the latest version of the Adobe Flash Player in order to play Youtube videos (see also Install Adobe Flash Player, page 31).

Notice



Calendar

There is no calendar pre-installed on the Pocket Projector.

Install Adobe Flash Player

You need to install the latest version of the Adobe Flash Player in order to play Youtube videos.

- 1 Download the latest version of Adobe Flash Player installation package (**flashplayer.apk**) for Android. For further information visit www.philips.com/support.
- 2 Save the package onto a memory card.
- 3 Insert the memory card into the device (see also Inserting a Memory Card, page 18).
- 4 Switch the device on using the on/off switch on the side.
- 5 After the initial screen the main menu appears.

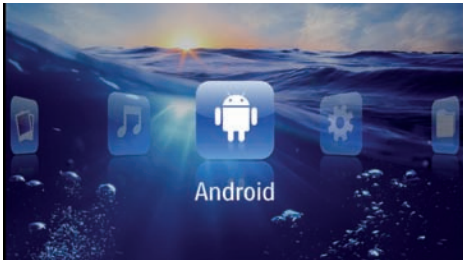

- 6 Use the navigation keys to select **Android**.
- 7 Confirm with **OK**.
- 8 Use the navigation keys to select **Explorer**.

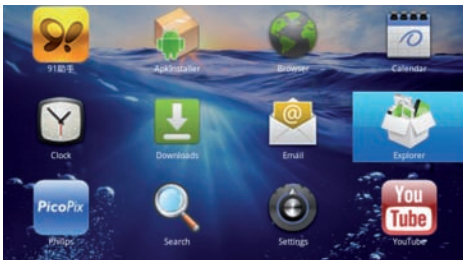

- 9 Confirm with **OK**.
- 10 Navigate to the memory card and select **flashplayer.apk**.

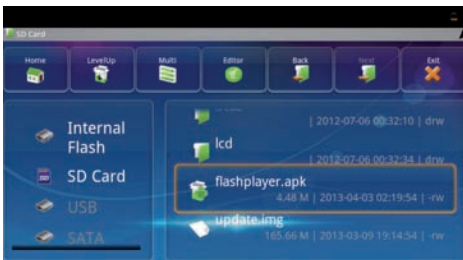

- 11 Press **OK** to execute the installation package.

- 12 Use the navigation keys to select **Install**.

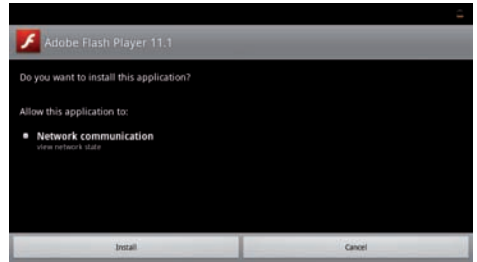

- 13 Press **OK** to start the installation.
- 14 Use the navigation keys to select **Done**.

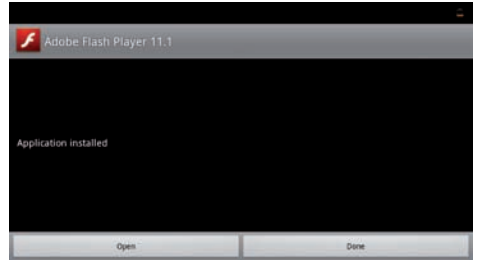

- 15 Confirm with **OK**.
- 16 The latest version of Adobe Flash Player is installed.

Adjust Browser Mode

Change the browser mode to display websites containing flash elements.

- 1 Switch the device on using the on/off switch on the side.
- 2 After the initial screen the main menu appears.



- 3 Use the navigation keys to select **Android**.
- 4 Confirm with **OK**.
- 5 Use the navigation keys to select **Browser**.



- 6 Confirm with **OK**.
- 7 Press the menu key **☰** to call the menu.
- 8 Use the navigation keys to select **More**.

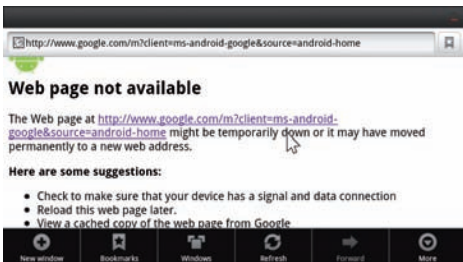

- 9 Confirm with **OK**.

- 10 Use the navigation keys to select **Settings**.

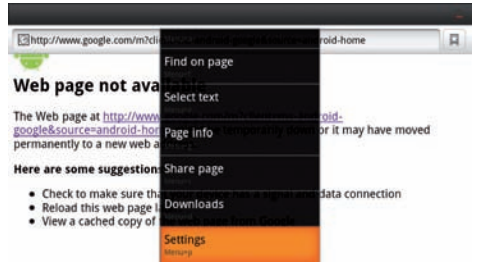

- 11 Confirm with **OK**.
- 12 Use the navigation keys to select **User agent**.

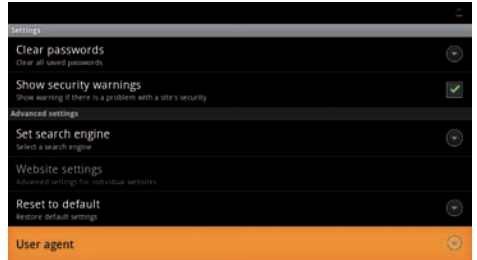

- 13 Confirm with **OK**.
- 14 Use the navigation keys to select **Desktop**.



- 15 Confirm with **OK**.
- 16 Websites containing flash elements can be displayed.

Reset Browser Mode

- 1 Proceed as described in the adjust browser mode chapter (see also Adjust Browser Mode, page 32).
- 2 Use the navigation keys to select **iPad**.

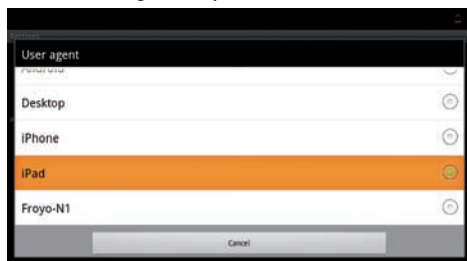

- 3 Confirm with **OK**.

10 Settings

- 1 Switch the device on using the on/off switch on the side.
- 2 After the initial screen the main menu appears.

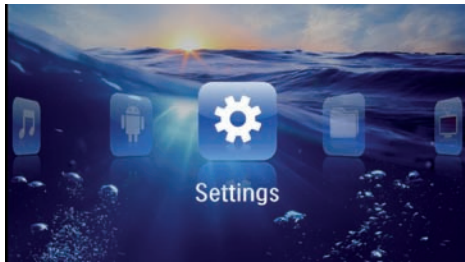

- 3 Use the navigation keys to select **Settings**.
- 4 Confirm with **OK**.
- 5 Use **▲/▼** to select from the following settings.

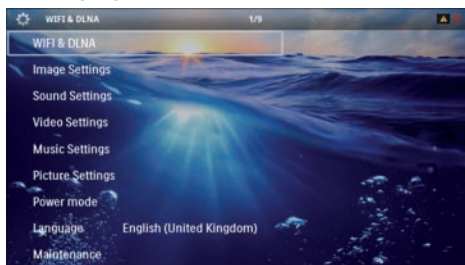

- 6 Confirm with **OK**.
 - 7 Modify the settings using **OK**, **▲/▼**.
 - 8 Confirm with **OK**.
- The **⏪** key takes you one step back in the menu.

Overview of the Menu Functions

WIFI & DLNA

WIFI Network – switching the wireless network (WLAN) off and on

Network Selection – select the wireless network with which the device is to connect

DLNA Sharing – switching DLNA off and on

WIFI Hot Spot – activate and deactivate WLAN tethering

Image settings

Wall paper – Select background images

Fit Screen – Convert videos and images to 4:3 resolution

Projection mode

Front – Normal projection; the device is located in front of the projection surface/screen

Rear – Rear projection; the device is located behind the projection surface; the image is reflected horizontally.

Ceiling – The device is hanging from the ceiling in an upside-down position; the image is rotated through 180 degrees.

Rear ceiling – The device is located behind the projection surface, hanging from the ceiling in an upside-down position; the image is rotated through 180 degrees and reflected horizontally.

Wall color correction – Colour correction of the projected image to adjust to coloured projection surfaces

Smart Settings – Select predefined settings for brightness / contrast / colour saturation. If you modify these settings, the setting is switched to **Manual**.

Brightness – Adjust brightness

Contrast – Adjust contrast

Sound Settings:

Volume – Adjust the volume

Bass – Set the playback of the low frequencies

Treble – Set the playback of the high frequencies

Key beep – Turn key tones on and off

Video settings

View – Display all videos in a list or a corresponding folder structure on the drive.

Repeat – Set the repeat type for video files: Repeat deactivated (**Off**), repeat all videos in a directory (**Directory**), repeat only the current video (**Movie**), repeat all videos (**All**).

Resume play – If this function is activated, playback will continue at the position it was last stopped. If deactivated, playback will always start at the beginning of the video.

Fit Screen – Convert videos to 4:3 resolution

Music settings

View – Show all tracks in a list or a corresponding folder structure on the drive.

Screen – Activate or deactivate the projection during playback.

Repeat – Set the repeat type for music files: Repeat deactivated (**Off**), repeat all songs in a directory (**Directory**), repeat only the current song (**Song**), repeat all songs (**All**).

Shuffle – Activate this function for random playback. Otherwise, playback will take place in sequence.

Picture settings

View – Display the images as a **thumbnail** or as a **list** during selection in the main menu.

Time per slide – Image viewing time during slide show

Repeat – Set the type of repeat for slide show photos: Repeat off (**Off**), repeat all photos in the directory (**Directory**), repeat all stored photos (**All**).

Slide transition – Set image transitions

Slideshow order – Play slide show in order or randomly

Power mode

Brightness mode – This function reduces the light output in order to increase the operating time for the built-in battery. When operating from the power supply, the energy saving mode is always deactivated in order to ensure the best-possible image display.

Sleep mode – With this function, the projector automatically shuts down after a specified period of time or at the end of a movie.

Language

Select the desired language for the menu.

Maintenance

Reset settings – Reset settings to factory defaults.

Firmware Update – Update Firmware

Notice



Connect for the duration of the firmware update the power adapter.

Information – Display free space in the internal memory and information on the device (Capacity: / Free space: / Firmware version: / Device name: / Model:)

II Service

Care Instructions for the Battery

The capacity of the battery diminishes with time. You can prolong the life of the battery if you observe the following points:

- Without a power supply, the device operates from the built-in battery. When the battery does not have sufficient capacity, the device turns off. Connect the device to the power supply.
- When the battery does not have sufficient capacity, the battery symbol in the display and turns red.
- When the device is running for a long period of time, the surface becomes hot and a warning symbol appears on the projection (see also Symbols in the Statusbar, page 10). The device behaves as follows:
 - 1 The fan turns to maximum level.
 - 2 At maximum level of brightness the overheat symbol appears in the status bar and the device turns automatically to minimum level of brightness.
 - 3 At minimal level of brightness the overheat symbol shows for three seconds in the middle of the screen. Then the device turns off automatically.

After the device has cooled down, you can continue playback.

- Use the device at least once a week.
- Charge the battery regularly. Don't store the device with a completely discharged battery.
- If the device is not used for several weeks, discharge the battery a little by using the device before storing it.
- If the device only works using the USB connection or with the power supply, the battery is defective.
- Keep the device and the battery away from sources of heat.

DANGER!



Do not Replace the Battery Yourself

Do not try to replace the battery yourself. Incorrect handling of the battery or using the wrong type of battery can cause damage to the device or cause injury.

Battery deep discharge

When the battery is in deep discharge or the device is not used for a longer period, proceed as followed:

- 1 Connect the device to the power supply (see also Connect Power Supply / Charge Battery, page 11). The device behaves as follows:

| | Device off | Device on |
|------------------------------|---------------------------------------------------------------------------|--------------------------------------------------------------------------------------|
| Connect to a computer | The indicator light on the side of the device turns red. Slow charging | Connect to a computer (see also Connect to a Computer (USB), page 19) No charging |
| Connect to the power adapter | The indicator light on the side of the device turns red. Fast charging | Device remains turned on. Slow charging |

- 2 The device can be turned on and is ready to use after approximately five minutes of charging time.

Battery recharge time with device off

| | Turning on possible | Completely charged |
|---------------|----------------------------|---------------------------|
| Slow charging | 5 minutes | 10 hours |
| Fast charging | 5 minutes | 2 hours |

Cleaning

DANGER!



Instructions for Cleaning!

Use a soft, lint-free cloth. Never use liquid or easily flammable cleansers (sprays, abrasives, polishes, alcohol, etc.). Do not allow any moisture to reach the interior of the device. Do not spray the device with any cleaning fluids.

Wipe over the surfaces gently. Be careful that you do not scratch the surfaces.

Cleaning the Lens

Use a brush or lens cleaning paper for cleaning the lens of the projector.

DANGER!



Do not use any Liquid Cleaning Agents

Do not use any liquid cleaning agents for cleaning the lens, to avoid damaging the coating film on the lens.

Device Overheated

A overheat symbol appears if the device is overheated (see also Symbols in the Statusbar, page 10). The device behaves as follows:

- 1 The fan turns to maximum level.
- 2 At maximum level of brightness the symbol appears in the status bar and the device turns automatically to minimum level of brightness.
- 3 At minimal level of brightness the symbol shows for three seconds in the middle of the screen. Then the device turns off automatically.

After the device has cooled down, you can continue playback.

Update Firmware with Memory Card

Notice



Connect for the duration of the firmware update the power adapter (see also Connect Power Supply / Charge Battery, page 11).

- 1 Format the memory card in the file system FAT16 or FAT32.

DANGER!



All Data will be Deleted!

This procedure erases all your data that is stored on the memory card.

- 2 Save the latest firmware update file to the memory card.
- 3 Insert the memory card (see also Inserting a Memory Card, page 18) and switch the device on.
- 4 Use the navigation keys to select **Settings**.
- 5 Confirm with **OK**.
- 6 Use **▲/▼** to select **Maintenance**.
- 7 Confirm with **OK**.
- 8 Use **▲/▼** to select **Firmware Update**.
- 9 Confirm with **OK**.
- 10 Use **▲/▼** to select **Install**.
- 11 Confirm with **OK**.
- 12 The device turns off and on again. After around 5 minutes the **Language Selection** screen appears. The firmware update is now completed.

DANGER!



Inserting a Memory Card!

Never pull out the memory card while the device is accessing it. This could cause data to be damaged or lost.

DANGER!



Power!

Do not unplug the power adapter during the firmware update.

Notice



If an error occurs during the firmware update process retry the procedure or contact your dealer.

Troubleshooting

Power Cycling

If a problem occurs that cannot be corrected with the instructions in this user manual (see also the help below), follow the steps given here.

- 1 Switch the device off using the on/off switch on the side.
- 2 Wait at least ten seconds.
- 3 Switch the device on using the on/off switch on the side.
- 4 If the problem repeats, please contact our technical customer service or your retailer.

| Problems | Solutions |
|-------------------------------------------------------------------------------|--------------------------------------------------------------------------------------------------------------------------------------------------------------------------------------------------------------------------------------------------------------------------------------------------------------------------------------------------------------------------------------------------------------------------------------------------------------------------------|
| The Pocket Projector is unresponsive or hung up | <ul style="list-style-type: none">• Insert a slim, pointy object into the reset hole to trigger a hardware reset (see also Side View, page 5) |
| The Pocket Projector cannot be switched on | <ul style="list-style-type: none">• Connect the supplied power supply to recharge the internal battery. |
| No sound | <ul style="list-style-type: none">• Adjust the volume using the / key on the remote control. |
| No sound from the external connected device | <ul style="list-style-type: none">• Check the cables to the external device• Set the volume on the external device• Only the original cables from the device manufacturer may function |
| Bad sound quality with your computer connection | <ul style="list-style-type: none">• Check if the audio cable is connected to the computer's headphone socket or the line-out socket.• The volume setting on the computer should not be too high. |
| Only the initial screen appears and not the image from the external device | <ul style="list-style-type: none">• Check if the cables are connected to the right sockets.• Please check that the external device is switched on• Check if the video output of the external device is switched on. |
| Only the initial screen appears and not the image from the connected computer | <ul style="list-style-type: none">• Please check that the VGA-output of the computer is switched on.• Check if the resolution of the computer is set to 800x600. |
| Device switches turns off | <ul style="list-style-type: none">• When the device is running for a long period of time, the surface becomes hot and a warning symbol appears on the projection (see also Symbols in the Statusbar, page 10). The device automatically turns off when it gets too hot. After the device has cooled down, you can continue playback.• When the battery does not have sufficient capacity, the device turns off. Connect the device to the power supply. |
| The device is connected to the power supply and switches to stand-by mode | <ul style="list-style-type: none">• The battery is in deep discharge. The device can be turned on and is ready to use after approximately five minutes of charging time (see also Battery deep discharge, page 36). |

| Problems | Solutions |
|-------------------------------------------------------------------------------------------------------------------------------------------------------|----------------------------------------------------------------------------------------------------------------------------------------------------------------------------------------------------------------------------------------------------------------------------------------------------------|
| <p>Devices changes from maximum level of brightness to minimum level of brightness when the device is connected over USB to play videos.</p> | <ul style="list-style-type: none"> • When the environment temperature is too high, the devices turns automatically from maximum level of brightness to minimum level of brightness in order to protect the high power LED. • Use the device with lower environment temperatures. |
| <p>Device cannot connect with an Android device (for example a mobile phone/smartphone with the Android operating system) when connected via USB.</p> | <ul style="list-style-type: none"> • Deactivate the function „USB debugging“ in the settings menu of your Android device before connecting the Pocket Projector via USB; your Android device should be recognized as USB storage medium. |
| <p>Bad image or color quality when connecting with HDMI</p> | <ul style="list-style-type: none"> • Use the supplied HDMI cable (PPA1290). Third-party cables may cause signal distortions. |

I 2 Appendix

Technical Data

| | |
|--------------------------------|-------------------------------------------------------------------------------|
| Dimensions (L × H × W)..... | 105 × 32 × 105 mm |
| Weight..... | 0.284 kg |
| Recommended Ambient..... | 5 – 35 °C |
| Relative Humidity..... | 15 – 85 % (non-condensing) |
| File format..... | *.mp4, *.avi, *.mov, *.mkv, *.mpg,*.mpeg, *.flv, *.ts, *.m2ts, *.3gp |
| Photo formats..... | JPEG, BMP, PNG, GIF |
| Music formats..... | MP3, WAV, WMA |
| Video Standard (CVBS)..... | PAL, SECAM, NTSC |
| Video Standard (YPbPr).... | 480i/p, 576i/p, 720p, 1080i/p |
| Video connection..... | Mini-HDMI socket |
| Headphone connection..... | Stereo - jack plug: 3,5 mm |
| Internal speaker..... | mono 1 W |
| Internal memory..... | 2.5 GB |
| Compatible Memory Cards..... | SD/SDHC/SDXC/MMC |
| USB connection max. power..... | 5V, 500mA |

Technology / optical

| | |
|-------------------------------|----------------------------------------|
| Display technology..... | WVGA 0,3" DLP |
| Light source..... | RGB LED |
| Resolution..... | 854 × 480 Pixel (16:9) |
| Supported Resolutions..... | VGA/SVGA/WVGAXGA/WXGA/FULL HD |
| Brightness (Bright Mode)..... | up to 140 lumen |
| Contrast ratio..... | 1000:1 |
| Projected image size..... | 12 – 120 inch |
| Screen distance..... | 0,5 m up to 5 m |
| Horizontal Scan Rate..... | 31 – 69 kHz |
| Vertical Scan Rate..... | 56 – 85 Hz |

Power supply

| | |
|-------------------|----------------------------------|
| Model No..... | MPA-630 |
| Input..... | 100 – 240V~, 50 – 60 Hz, max. 1A |
| Output..... | 12V $\overline{\text{---}}$, 2A |
| Manufacturer..... | Wanlida Group Co., Ltd. |

Built-in rechargeable battery

| | |
|--------------------------------|--------------|
| Battery type..... | LiPol |
| Capacity..... | 1800mAh 7.4V |
| Charging time..... | 2 h |
| Operating time..... | 1 h |
| Operating time (ECO mode)..... | 2 h |
| Manufacturer..... | Great Power |

Accessories

Following accessories are available for your device:

| | |
|-----------------------------------------------------------|---------------------|
| Pico Station with battery and speakers..... | PPA7300 / 253529749 |
| Pico Station mit battery, speakers and DVB-T adapter..... | PPA7301 / 253532895 |
| USB DVB-T Stick..... | PPA8301 / 253529757 |
| YUV/YPbPr cable..... | PPA1210 / 253447083 |
| Video-(CVBS) cable..... | PPA1320 / 253526178 |
| VGA cable..... | PPA1250 / 253447070 |
| iPhone/iPad/iPod-HDMI cable .. | PPA1280 / 253447091 |
| iPhone/iPad/iPod-A/V cable | PPA1160 / 253372471 |
| MHL cable..... | PPA1240 / 253520048 |

All data are provided for reference purposes only. **Sagemcom Documents SAS** reserves the right to make any changes without prior notice.



The CE marking certifies that the product meets the main requirements of the European Parliament and Council directives 1999/5/CE, 2006/95/CE, 2004/108/CE and 2009/125/CE on information technology equipment, regarding safety and health of users and regarding electromagnetic interference.

The declaration of compliance can be consulted on the site www.picopix.philips.com.

Preservation of the environment as part of a sustainable development plan is an essential concern of Sagemcom Documents SAS. The desire of Sagemcom Documents SAS is to operate systems observing the environment. The desire of Sagemcom Documents SAS is to operate systems observing the environment and consequently it has decided to integrate environmental performances in the life cycle of this products, from manufacturing to commissioning use and elimination.



Packaging: The presence of the logo (green dot) means that a contribution is paid to an approved national organisation to improve package recovery and recycling infrastructures. Please respect the sorting rules set up locally for this kind of waste.

Batteries: If your product contains batteries, they must be disposed of at an appropriate collection point.



Product: The crossed-out waste bin stuck on the product means that the product belongs to the family of electrical and electronic equipment. In this respect, the European regulations ask you to dispose of it selectively;

- At sales points in the event of the purchase of similar equipment.
- At the collection points made available to you locally (drop-off centre, selective collection, etc.).

In this way you can participate in the re-use and upgrading of Electrical and Electronic Equipment Waste, which can have an effect on the environment and human health.

The paper and cardboard packaging used can be disposed of as recyclable paper. Have the plastic wrapping recycled or dispose of it in the non-recyclable waste, depending on the requirements in your country.

Trademarks: The mentioned references in this manual are trademarks of the respective companies. The lack of the trademarks ® and ™ does not justify the assumption that these dedicated terminologies are free trademarks. Other product names used herein are for identification purposes only and may be trademarks of their respective owners. Sagemcom Documents SAS disclaims any and all rights in those marks.

Neither Sagemcom Documents SAS nor its affiliates shall be liable to the purchaser of this product or third parties for damages, losses, costs, or expenses incurred by the purchaser or third parties as a result of accident, misuse, or abuse of this product or unauthorized modifications, repairs, or alterations to this product, or failure to strictly comply with Sagemcom Documents SAS operating and maintenance instructions.

Sagemcom Documents SAS shall not be liable for any damages or problems arising from the use of any options or any consumable materials other than those designated as original Sagemcom Documents SAS / PHILIPS products or Sagemcom Documents SAS / PHILIPS approved products.

Sagemcom Documents SAS shall not be held liable for any damage resulting from electromagnetic interference that occurs from the use of any interface cables other than those designated as Sagemcom Documents SAS / PHILIPS products.

All rights reserved. No part of this publication may be reproduced, stored in a retrieval system or transmitted in any form or by any means, electronic, mechanical, photocopying, recording, or otherwise, without the prior written permission of Sagemcom Documents SAS. The information contained herein is designed only for use with this product. Sagemcom Documents SAS is not responsible for any use of this information as applied to other devices.

This user manual is a document that does not represent a contract.

Errors, printing errors and changes are reserved.

Copyright © 2014 Sagemcom Documents SAS



PHILIPS and the PHILIPS' Shield Emblem are registered trademarks of Koninklijke Philips N.V. and are used by Sagemcom Documents SAS under license from Koninklijke Philips N.V.

© 2014 Sagemcom Documents SAS
All rights reserved

Sagemcom Documents SAS

Documents Business Unit

Headquarters: CS 50001

92848 Rueil Cedex - FRANCE

Tel: +33 (0)1 57 61 10 00 · Fax: +33 (0)1 57 61 10 01

www.sagemcom.com

Simplified Joint Stock Company · Capital 8.479.978 € · 509 448 841 RCS Nanterre

PPX3614

EN

253604307-C